

DESCRIPTION: **HIGH DENSITY MALE SOLDER CUP**

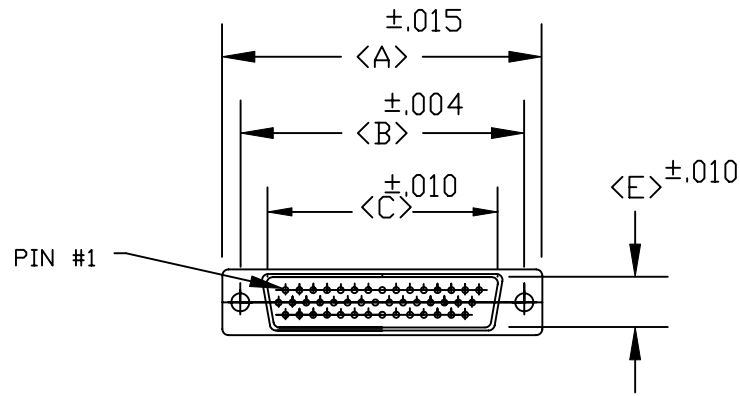

4 ROW

| POS. | A     | B     | C     | D     | E     | F     | G     |
|------|-------|-------|-------|-------|-------|-------|-------|
| 15   | 1.213 | 0.984 | 0.666 | 0.756 | 0.329 | 0.090 | 0.496 |
|      | 30.80 | 24.99 | 16.92 | 19.20 | 8.36  | 2.29  | 12.60 |
| 26   | 1.543 | 1.312 | 0.994 | 1.091 | 0.329 | 0.090 | 0.496 |
|      | 39.19 | 33.32 | 25.25 | 27.70 | 8.36  | 2.29  | 12.60 |
| 44   | 2.087 | 1.852 | 1.534 | 1.618 | 0.329 | 0.090 | 0.496 |
|      | 53.00 | 47.04 | 38.96 | 41.10 | 8.36  | 2.29  | 12.60 |
| 62   | 2.732 | 2.500 | 2.181 | 2.256 | 0.329 | 0.095 | 0.496 |
|      | 69.30 | 63.50 | 55.42 | 57.30 | 8.36  | 2.41  | 12.60 |
| 78   | 2.638 | 2.406 | 2.079 | 2.169 | 0.445 | 0.095 | 0.606 |
|      | 67.00 | 61.00 | 52.80 | 55.10 | 11.30 | 2.41  | 15.39 |

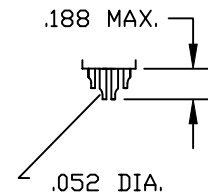
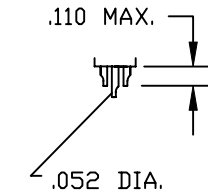
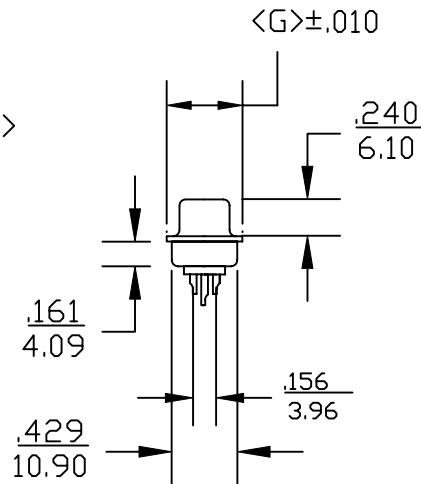
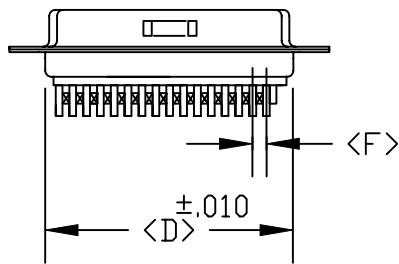

180-XXX-102-XX1

SERIES \_\_\_\_\_  
 POSITIONS \_\_\_\_\_  
 015  
 026  
 044  
 062  
 078  
 GENDER \_\_\_\_\_  
 1 = MALE  
 2 = FEMALE  
 TERMINATION \_\_\_\_\_  
 0 = SOLDER CUP  
 SHELL PLATING \_\_\_\_\_  
 2 = TIN  
 HARDWARE OPTIONS \_\_\_\_\_  
 00 = NO HARDWARE (.120Ø HOLE)  
 01 = 4-40 CLINCH-NUT .098" BOARD SIDE  
 02 = 4-40 CLINCH NUT .250" BOARD SIDE  
 03 = 4-40 CLINCH NUT .250" MATING SIDE  
 91 = 4-40 SPACER/BOARD LOCK .225"  
 PLATING OPTIONS \_\_\_\_\_  
 1 = GOLD FLASH  
 2 = 30 MICRO-INCH GOLD

**ELECTRICALS:**

CURRENT RATING: 2 AMPS  
 CONTACT RESISTANCE: 15 mOHMS MAX.  
 INSULATOR RESISTANCE: 1000MOHMS MIN.  
 VOLTAGE: 500V FOR 1 MINUTE  
 TEMPERATURE: -50° TO +100°

**MATERIALS:**

SHELL: STEEL, TIN PLATED  
 INSULATOR: PBT - BLACK (UL-94-VO)

NOTE: WILL ACCEPT UPTO 24 AWG WIRE

|  |   |                                   |                         |
|--|---|-----------------------------------|-------------------------|
|  | THESE DRAWINGS AND SPECIFICATIONS ARE THE PROPERTY OF NorComp AND SHALL NOT BE REPRODUCED, COPIED OR USED AS THE BASIS FOR THE MANUFACTURE OR SALE OF APPARATUS WITHOUT WRITTEN PERMISSION. | DRAWN:<br><b>PAM JENKINS</b>      | DATE:<br><b>8-12-98</b> |
|  |   | CHECKED:                          | DATE:                   |
| NorComp  |   | SCALE:                            | SHEET OF                |
|  |   | DWG NO.<br><b>180-XXX-102-XX1</b> | REV<br><b>4</b>         |

**DESCRIPTION:** CLINCH NUT HARDWARE

ALL CLINCH-NUTS ARE 4-40 INTERNAL THREADS

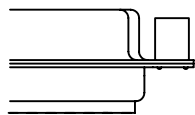

03X..... .250" (MATING SIDE) - CN8

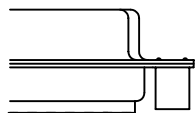

02X ..... .250" (BOARD SIDE) - CN2

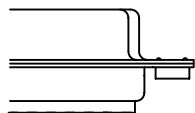

01X ..... .098" (BOARD SIDE) - CN1

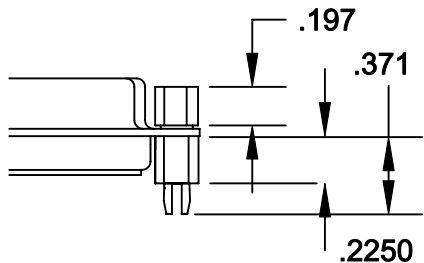

91X ..... .225" (BOARD SIDE) - .197 MATING SIDE - CN10/SFS0440

NOTE: 4-40 FEMALE SCREW LOCK IS REMOVABLE

|  |   |  |                            |                  |
|--|---|--|----------------------------|------------------|
|  | THESE DRAWINGS AND SPECIFICATIONS ARE THE PROPERTY OF NorComp AND SHALL NOT BE REPRODUCED, COPIED OR USED AS THE BASIS FOR THE MANUFACTURE OF SALE OF APPARATUS WITHOUT WRITTEN PERMISSION. |  | DRAWN:<br>WAYNE ROBBINS    | DATE:<br>8-23-98 |
|  | NorComp   |  | CHECKED:<br>PAM JENKINS    | DATE:<br>8-24-98 |
| SCALE:   |   |  | SHEET <b>1</b> OF <b>1</b> | REV <b>1</b>     |
| DWG NO.  |   |  | CLINCH-NUT OPTIONS         |                  |