

# Standard Heat Sinks

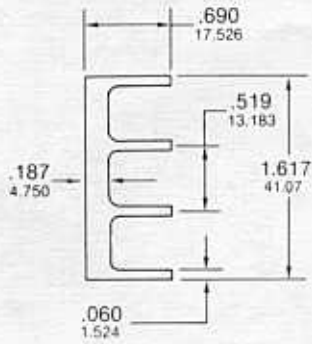

Material . . . . 6063-T5 Aluminum  
Finish . . . . . Black Anodize

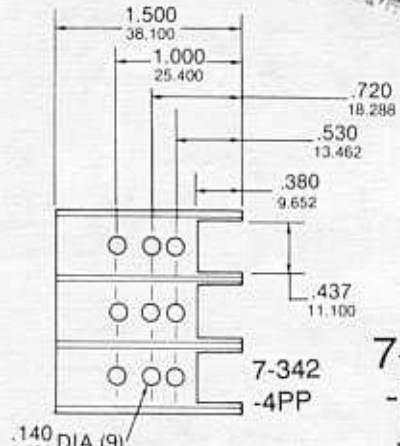
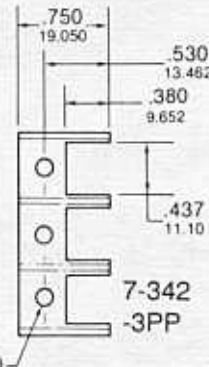
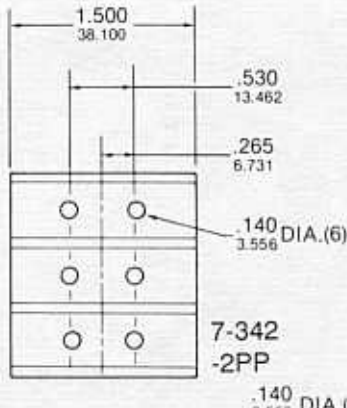
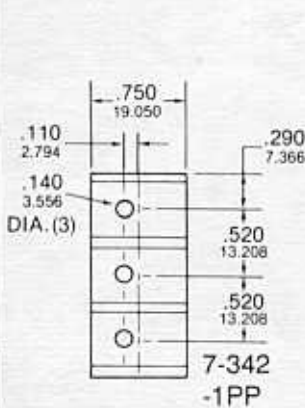
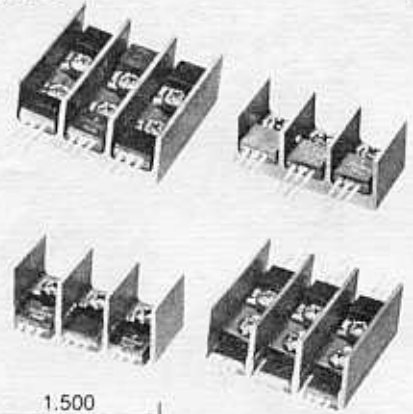
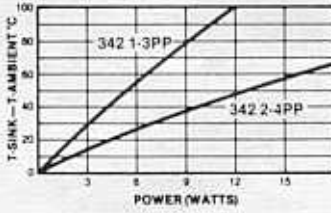

7-342  
-1,-2,  
-3,-4

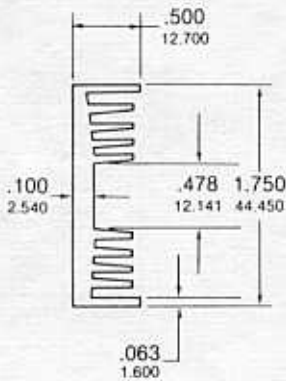

Material . . . . 6063-T5 Aluminum  
Finish . . . . . Black Anodize

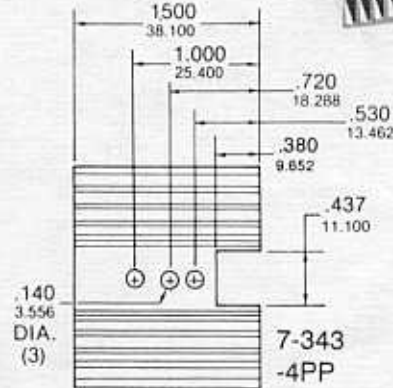
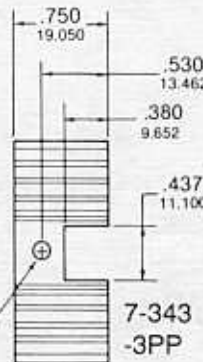
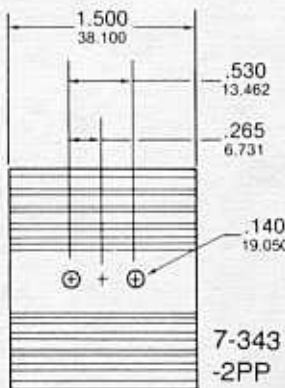
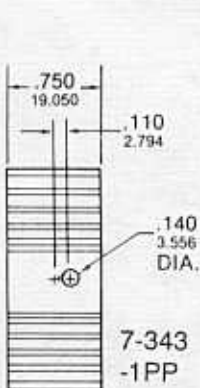
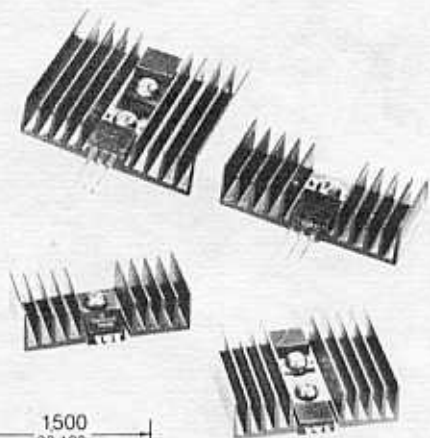
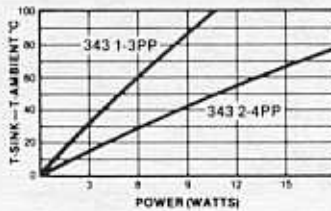

7-343  
-1,-2,  
-3,-4

## Low Power