

## Important notice

Dear Customer,

On 7 February 2017 the former NXP Standard Product business became a new company with the tradename **Nexperia**. Nexperia is an industry leading supplier of Discrete, Logic and PowerMOS semiconductors with its focus on the automotive, industrial, computing, consumer and wearable application markets

In data sheets and application notes which still contain NXP or Philips Semiconductors references, use the references to Nexperia, as shown below.

Instead of <http://www.nxp.com>, <http://www.philips.com/> or <http://www.semiconductors.philips.com/>, use <http://www.nexperia.com>

Instead of [sales.addresses@www.nxp.com](mailto:sales.addresses@www.nxp.com) or [sales.addresses@www.semiconductors.philips.com](mailto:sales.addresses@www.semiconductors.philips.com), use [salesaddresses@nexperia.com](mailto:salesaddresses@nexperia.com) (email)

Replace the copyright notice at the bottom of each page or elsewhere in the document, depending on the version, as shown below:

- © NXP N.V. (year). All rights reserved or © Koninklijke Philips Electronics N.V. (year). All rights reserved

Should be replaced with:

- © **Nexperia B.V. (year). All rights reserved.**

If you have any questions related to the data sheet, please contact our nearest sales office via e-mail or telephone (details via [salesaddresses@nexperia.com](mailto:salesaddresses@nexperia.com)). Thank you for your cooperation and understanding,

Kind regards,

Team Nexperia

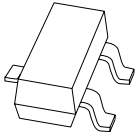

# 2N7002CK

60 V, 0.3 A N-channel Trench MOSFET

Rev. 01 — 11 September 2009

Product data sheet

## 1. Product profile

### 1.1 General description

ESD protected N-channel enhancement mode Field-Effect Transistor (FET) in a small SOT23 (TO-236AB) Surface-Mounted Device (SMD) plastic package using Trench MOSFET technology.

### 1.2 Features

- Logic-level compatible
- Very fast switching
- Trench MOSFET technology
- ESD protection up to 3 kV

### 1.3 Applications

- Relay driver
- High-speed line driver
- Low-side loadswitch
- Switching circuits

### 1.4 Quick reference data

Table 1. Quick reference data

Symbol	Parameter	Conditions	Min	Typ	Max	Unit
$V_{DS}$	drain-source voltage		-	-	60	V
$I_D$	drain current		-	-	300	mA
$I_{DM}$	peak drain current	single pulse; $t_p \leq 10 \mu\text{s}$	-	-	1.2	A
$R_{DS(on)}$	drain-source on-state resistance	$V_{GS} = 10 \text{ V};$ $I_D = 500 \text{ mA}$	-	1.1	1.6	$\Omega$

## 2. Pinning information

Table 2. Pinning

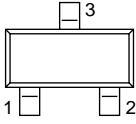
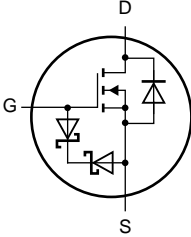
Pin	Symbol	Description	Simplified outline	Graphic symbol
1	G	gate		
2	S	source		
3	D	drain		

017aaa000

## 3. Ordering information

Table 3. Ordering information

Type number	Package		
	Name	Description	Version
2N7002CK	TO-236AB	plastic surface-mounted package; 3 leads	SOT23

## 4. Marking

Table 4. Marking codes

Type number	Marking code <sup>[1]</sup>
2N7002CK	LP*

- [1] \* = -: made in Hong Kong  
 \* = p: made in Hong Kong  
 \* = t: made in Malaysia  
 \* = W: made in China

## 5. Limiting values

**Table 5. Limiting values**

In accordance with the Absolute Maximum Rating System (IEC 60134).

Symbol	Parameter	Conditions	Min	Max	Unit
V <sub>DS</sub>	drain-source voltage	25 °C ≤ T <sub>j</sub> ≤ 150 °C	-	60	V
V <sub>GS</sub>	gate-source voltage		-	±20	V
I <sub>D</sub>	drain current	V <sub>GS</sub> = 10 V			
		T <sub>amb</sub> = 25 °C	-	300	mA
		T <sub>amb</sub> = 100 °C	-	190	mA
I <sub>DM</sub>	peak drain current	T <sub>amb</sub> = 25 °C; t <sub>p</sub> ≤ 10 μs	-	1.2	A
P <sub>tot</sub>	total power dissipation	T <sub>amb</sub> = 25 °C	[1]	350	mW
T <sub>j</sub>	junction temperature			150	°C
T <sub>amb</sub>	ambient temperature		-55	+150	°C
T <sub>stg</sub>	storage temperature		-65	+150	°C
<b>Source-drain diode</b>					
I <sub>S</sub>	source current	T <sub>amb</sub> = 25 °C	-	200	mA
I <sub>SM</sub>	peak source current	T <sub>amb</sub> = 25 °C; t <sub>p</sub> ≤ 10 μs	-	1.2	A
<b>ElectroStatic Discharge (ESD)</b>					
V <sub>ESD</sub>	electrostatic discharge voltage	all pins; human body model; C = 100 pF; R = 1.5 kΩ	-	3	kV

[1] Device mounted on an FR4 Printed-Circuit Board (PCB), single-sided copper, tin-plated, mounting pad for drain 1 cm<sup>2</sup>.

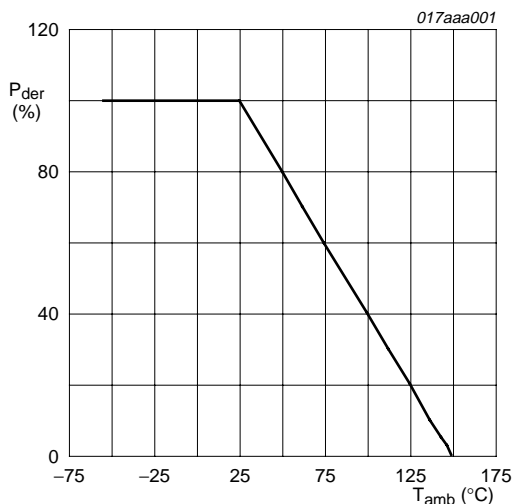

$$P_{der} = \frac{P_{tot}}{P_{tot(25^{\circ}C)}} \times 100\%$$

**Fig 1. Normalized total power dissipation as a function of ambient temperature**

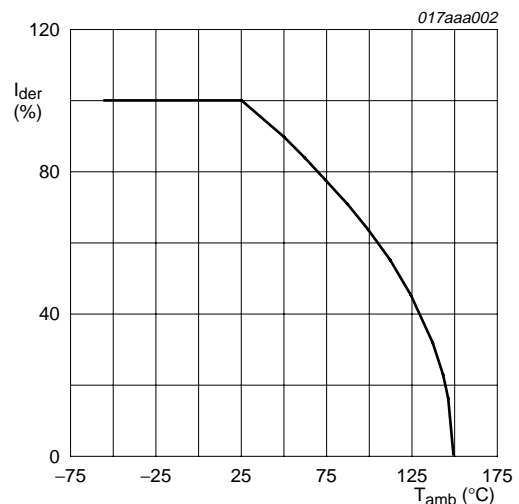

$$I_{der} = \frac{I_D}{I_{D(25^{\circ}C)}} \times 100\%$$

**Fig 2. Normalized continuous drain current as a function of ambient temperature**

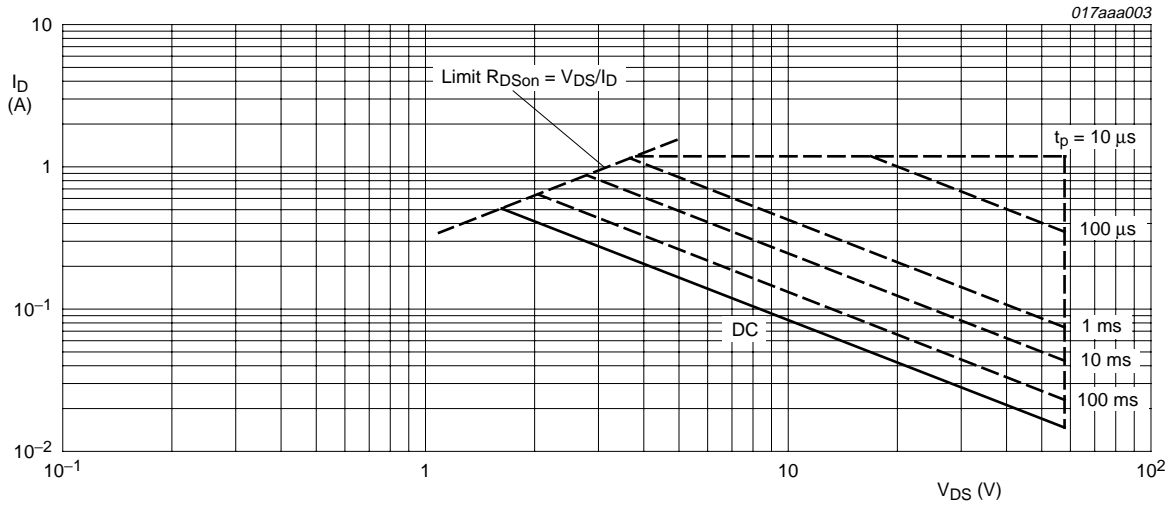

$T_{sp} = 25 \text{ }^\circ\text{C}$ ;  $I_{DM} = \text{single pulse}$ ;  $V_{GS} = 10 \text{ V}$

Fig 3. Safe operating area; junction to solder point; continuous and peak drain currents as a function of drain-source voltage

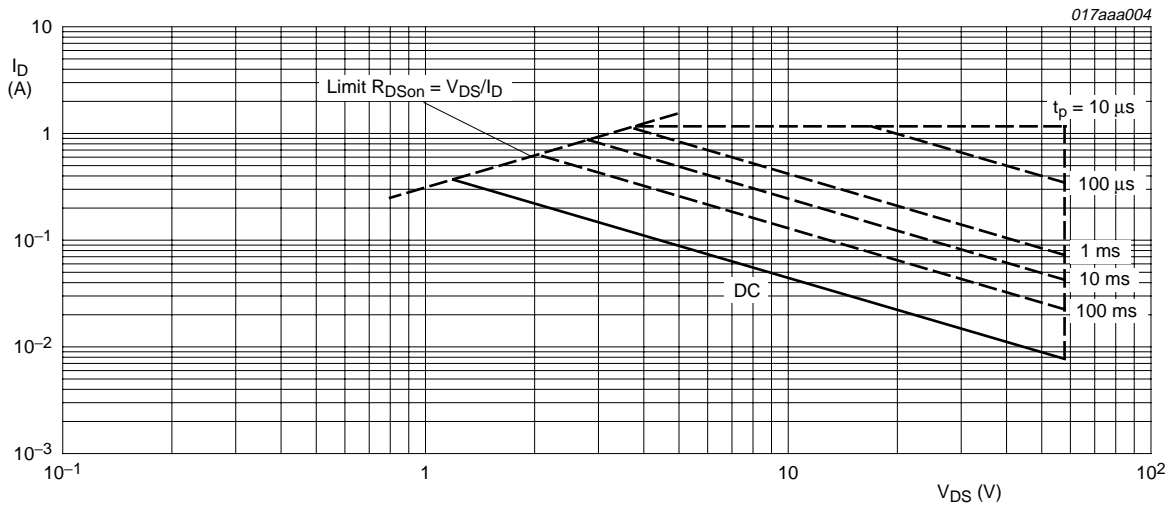

$T_{amb} = 25 \text{ }^\circ\text{C}$ ;  $I_{DM} = \text{single pulse}$ ;  $V_{GS} = 10 \text{ V}$

Fig 4. Safe operating area; junction to ambient; continuous and peak drain currents as a function of drain-source voltage

## 6. Thermal characteristics

Table 6. Thermal characteristics

Symbol	Parameter	Conditions	Min	Typ	Max	Unit
$R_{th(j-a)}$	thermal resistance from junction to ambient	in free air	[1] -	350	500	K/W

**Table 6. Thermal characteristics ...continued**

Symbol	Parameter	Conditions	Min	Typ	Max	Unit
$R_{th(j-sp)}$	thermal resistance from junction to solder point		-	-	150	K/W

[1] Device mounted on an FR4 PCB, single-sided copper, tin-plated and standard footprint.

## 7. Characteristics

**Table 7. Characteristics**

$T_{amb} = 25\text{ }^{\circ}\text{C}$  unless otherwise specified.

Symbol	Parameter	Conditions	Min	Typ	Max	Unit
<b>Static characteristics</b>						
$V_{(BR)DSS}$	drain-source breakdown voltage	$I_D = 10\text{ }\mu\text{A}; V_{GS} = 0\text{ V}$ $T_j = 25\text{ }^{\circ}\text{C}$	60	-	-	V
		$T_j = -55\text{ }^{\circ}\text{C}$	55	-	-	V
$V_{GS(th)}$	gate-source threshold voltage	$I_D = 250\text{ }\mu\text{A}; V_{DS} = V_{GS};$ $T_j = 25\text{ }^{\circ}\text{C}$	1	1.75	2.5	V
$I_{DSS}$	drain leakage current	$V_{DS} = 60\text{ V}; V_{GS} = 0\text{ V}$ $T_j = 25\text{ }^{\circ}\text{C}$	-	-	100	nA
		$T_j = 150\text{ }^{\circ}\text{C}$	-	-	1	$\mu\text{A}$
$I_{GSS}$	gate leakage current	$V_{GS} = \pm 20\text{ V}; V_{DS} = 0\text{ V}$	-	-	5	$\mu\text{A}$
		$V_{GS} = \pm 10\text{ V}; V_{DS} = 0\text{ V}$	-	50	450	nA
		$V_{GS} = \pm 5\text{ V}; V_{DS} = 0\text{ V}$	-	-	100	nA
$R_{DS(on)}$	drain-source on-state resistance	$V_{GS} = 4.5\text{ V};$ $I_D = 200\text{ mA}$ $T_j = 25\text{ }^{\circ}\text{C}$	-	1.3	3	$\Omega$
		$T_j = 150\text{ }^{\circ}\text{C}$	-	2.8	4.4	$\Omega$
		$V_{GS} = 10\text{ V}; I_D = 500\text{ mA}$	-	1.1	1.6	$\Omega$
<b>Dynamic characteristics</b>						
$Q_{G(tot)}$	total gate charge	$I_D = 200\text{ mA};$ $V_{DS} = 10\text{ V};$ $V_{GS} = 4.5\text{ V}$	-	1.09	1.3	nC
$Q_{GS}$	gate-source charge		-	0.22	-	nC
$Q_{GD}$	gate-drain charge		-	0.23	-	nC
$C_{iss}$	input capacitance	$V_{GS} = 0\text{ V}; V_{DS} = 25\text{ V};$ $f = 1\text{ MHz}$	-	47.2	55	pF
$C_{oss}$	output capacitance		-	11	20	pF
$C_{rss}$	reverse transfer capacitance		-	5	7.5	pF
$t_{d(on)}$	turn-on delay time	$V_{DS} = 15\text{ V};$ $R_L = 15\text{ }\Omega;$ $V_{GS} = 10\text{ V};$ $R_G = 6\text{ }\Omega$	-	8	15	ns
$t_r$	rise time		-	8	15	ns
$t_{d(off)}$	turn-off delay time		-	38	50	ns
$t_f$	fall time		-	22	35	ns
<b>Source-drain diode</b>						
$V_{SD}$	source-drain voltage	$I_S = 200\text{ mA}; V_{GS} = 0\text{ V}$	0.47	0.79	1.1	V

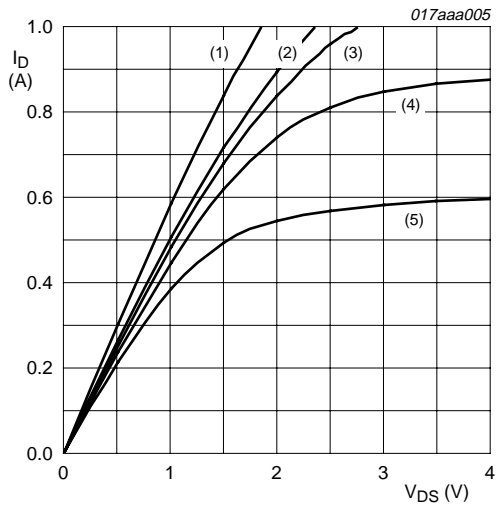

$T_j = 25\text{ }^\circ\text{C}$   
 (1)  $V_{GS} = 10\text{ V}$   
 (2)  $V_{GS} = 5\text{ V}$   
 (3)  $V_{GS} = 4.5\text{ V}$   
 (4)  $V_{GS} = 4\text{ V}$   
 (5)  $V_{GS} = 3.5\text{ V}$

**Fig 5. Output characteristics: drain current as a function of drain-source voltage; typical values**

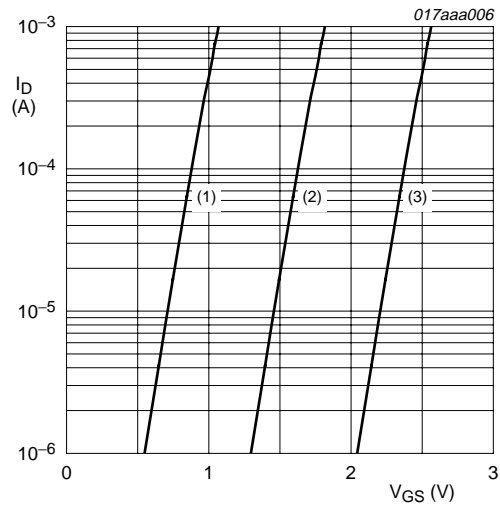

$T_j = 25\text{ }^\circ\text{C}; V_{DS} = 5\text{ V}$   
 (1) minimum values  
 (2) typical values  
 (3) maximum values

**Fig 6. Sub-threshold drain current as a function of gate-source voltage**

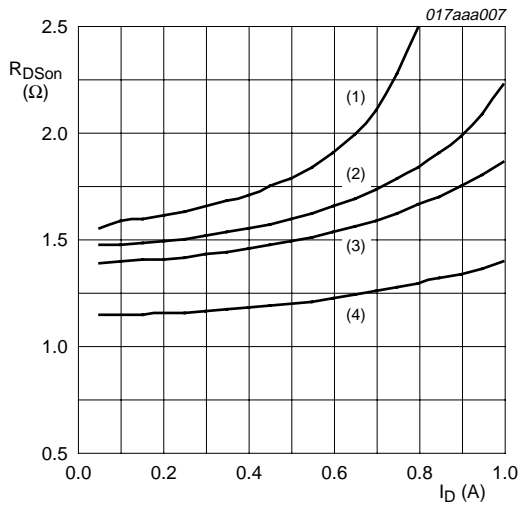

$T_j = 25\text{ }^\circ\text{C}$   
 (1)  $V_{GS} = 4\text{ V}$   
 (2)  $V_{GS} = 4.5\text{ V}$   
 (3)  $V_{GS} = 5\text{ V}$   
 (4)  $V_{GS} = 10\text{ V}$

**Fig 7. Drain-source on-state resistance as a function of drain current; typical values**

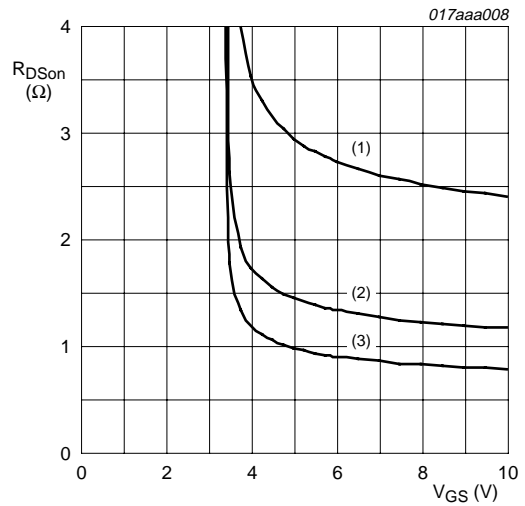

$I_D = 500\text{ mA}$   
 (1)  $T_j = 150\text{ }^\circ\text{C}$   
 (2)  $T_j = 25\text{ }^\circ\text{C}$   
 (3)  $T_j = -55\text{ }^\circ\text{C}$

**Fig 8. Drain-source on-resistance as a function of gate-source voltage; typical values**

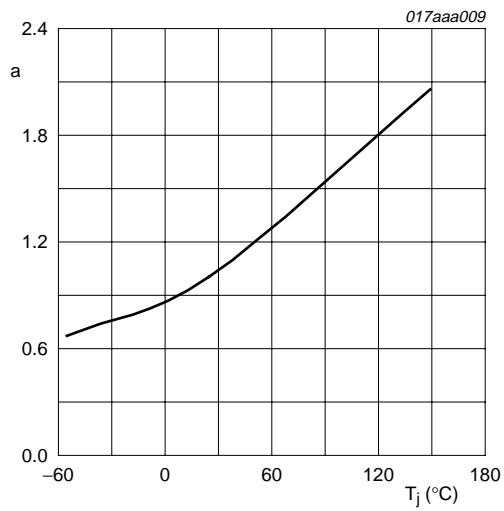

$$a = \frac{R_{DSon}}{R_{DSon(25^{\circ}C)}}$$

Fig 9. Normalized drain-source on-state resistance factor as a function of junction temperature

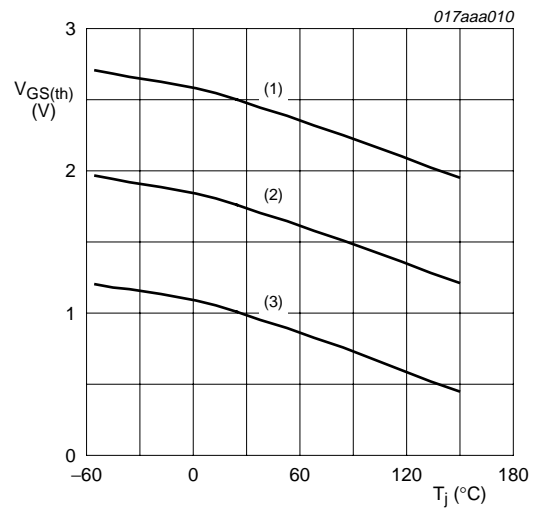

$I_D = 0.25 \text{ mA}; V_{DS} = V_{GS}$

- (1) maximum values
- (2) typical values
- (3) minimum values

Fig 10. Gate-source threshold voltage as a function of junction temperature

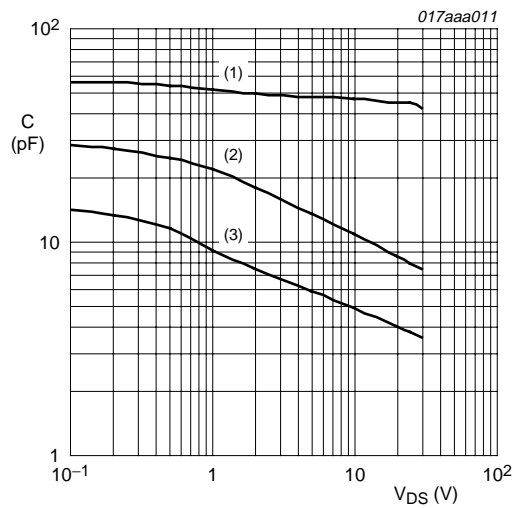

$V_{GS} = 0 \text{ V}; f = 1 \text{ MHz}$

- (1)  $C_{iss}$
- (2)  $C_{oss}$
- (3)  $C_{rss}$

Fig 11. Input, output and reverse transfer capacitances as a function of drain-source voltage; typical values



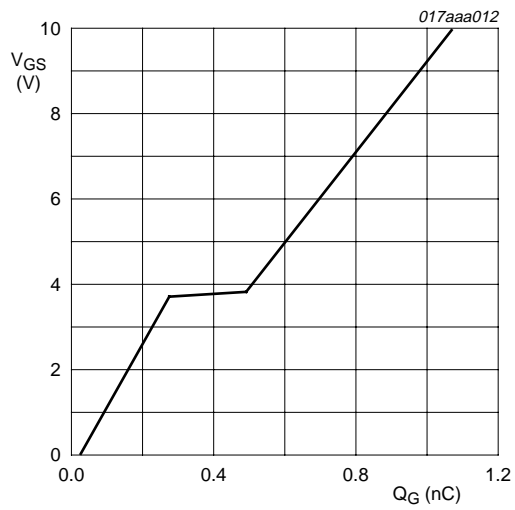

$I_D = 200 \text{ mA}$ ;  $V_{DD} = 30 \text{ V}$ ;  $T_j = 25 \text{ }^\circ\text{C}$

Fig 12. Gate-source voltage as a function of gate charge; typical values

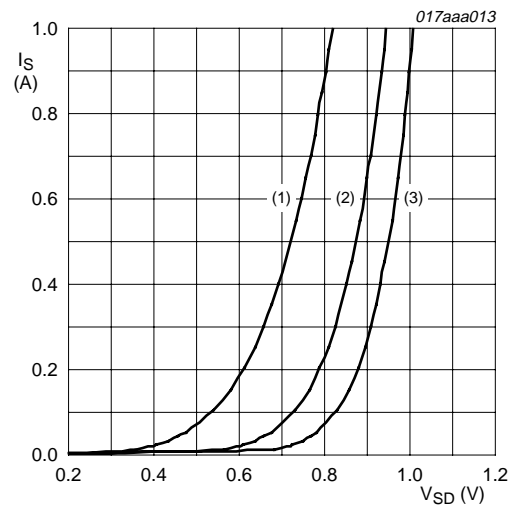

$V_{GS} = 0 \text{ V}$

- (1)  $T_j = 150 \text{ }^\circ\text{C}$
- (2)  $T_j = 25 \text{ }^\circ\text{C}$
- (3)  $T_j = -55 \text{ }^\circ\text{C}$

Fig 13. Source current as a function of source-drain voltage; typical values

8. Package outline

Plastic surface-mounted package; 3 leads

SOT23

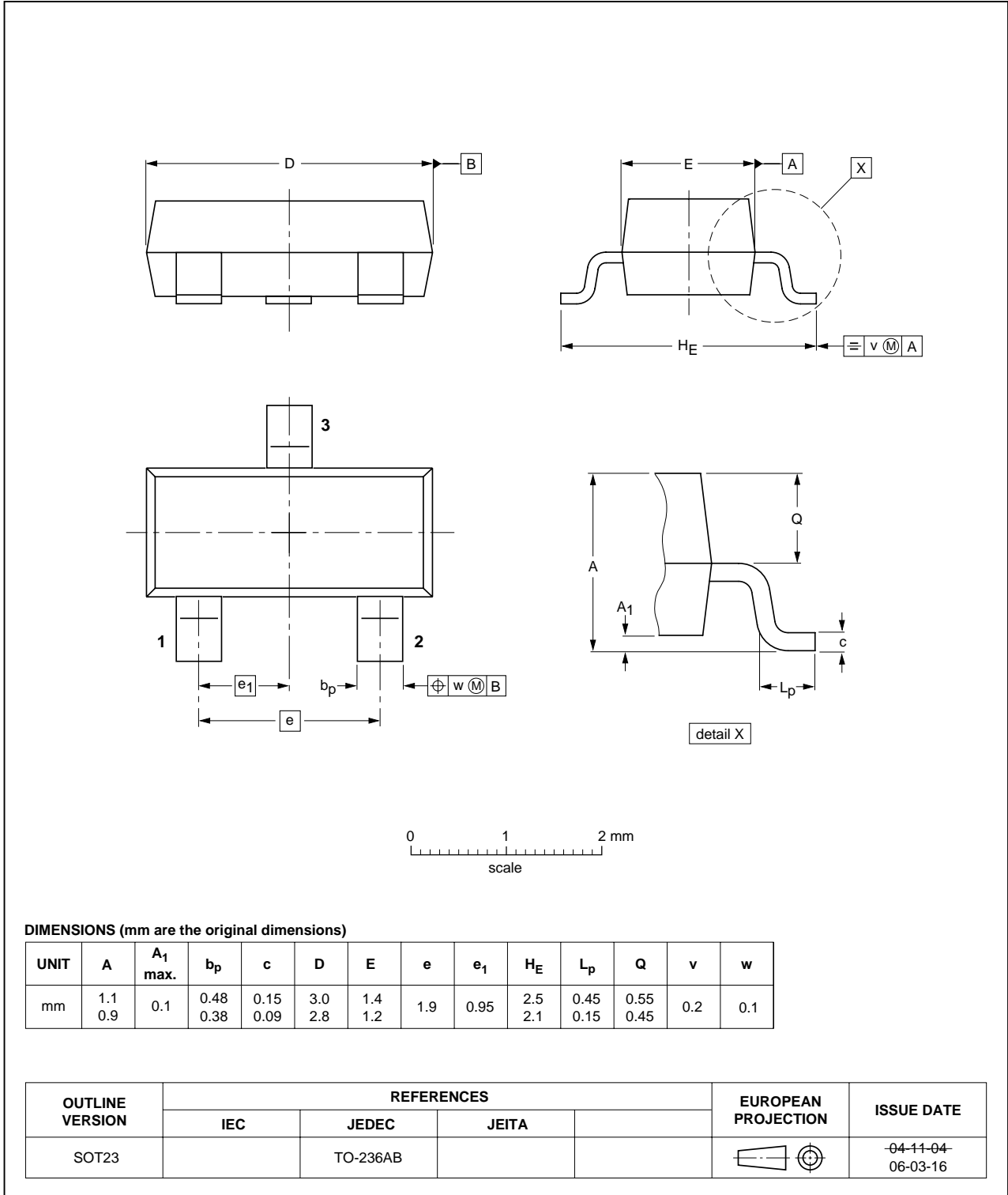

Fig 14. Package outline SOT23 (TO-236AB)

9. Soldering

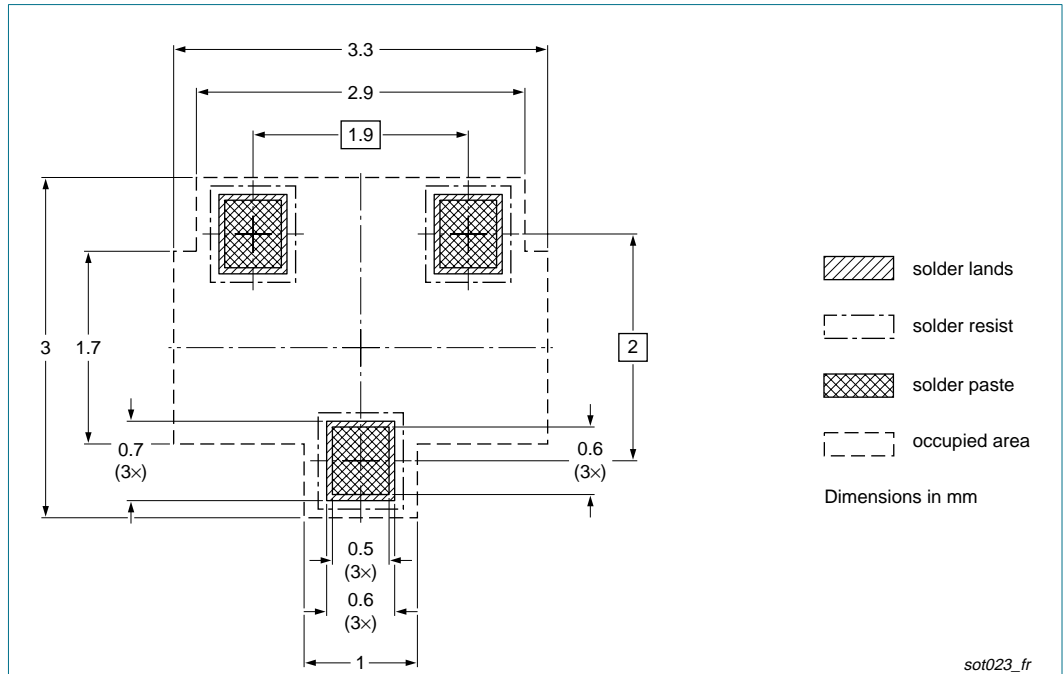

Fig 15. Reflow soldering footprint SOT23 (TO-236AB)

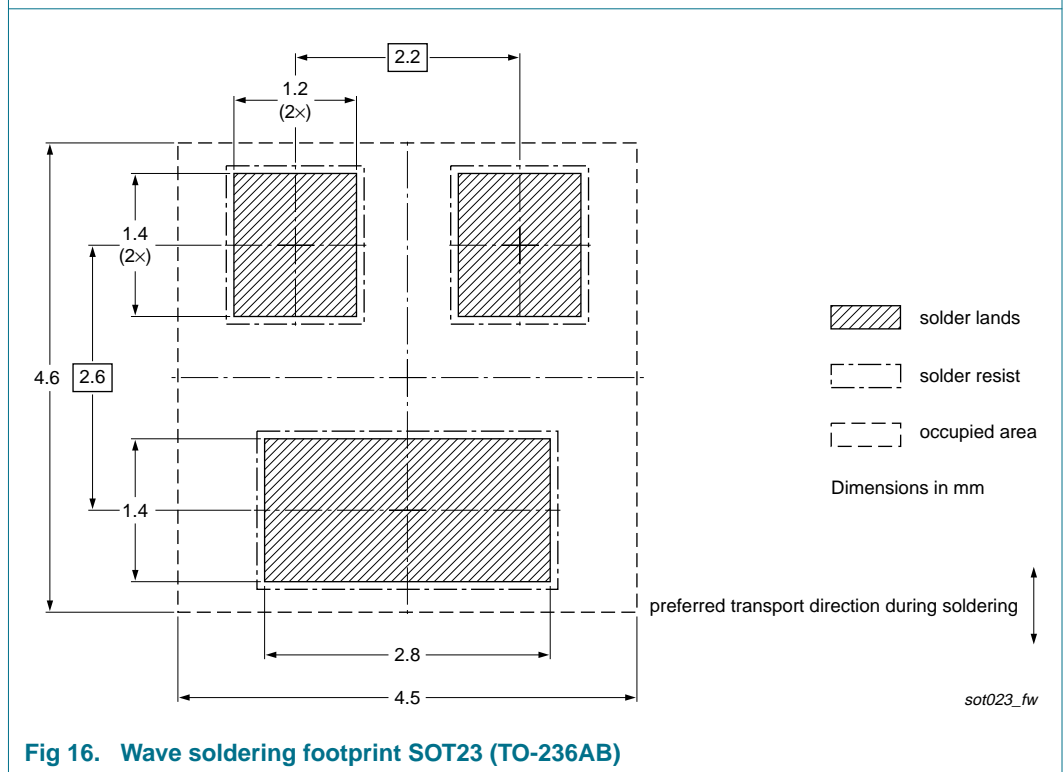

Fig 16. Wave soldering footprint SOT23 (TO-236AB)

## 10. Revision history

Table 8. Revision history

Document ID	Release date	Data sheet status	Change notice	Supersedes
2N7002CK_1	20090911	Product data sheet	-	-

## 11. Legal information

### 11.1 Data sheet status

Document status <sup>[1][2]</sup>	Product status <sup>[3]</sup>	Definition
Objective [short] data sheet	Development	This document contains data from the objective specification for product development.
Preliminary [short] data sheet	Qualification	This document contains data from the preliminary specification.
Product [short] data sheet	Production	This document contains the product specification.

[1] Please consult the most recently issued document before initiating or completing a design.

[2] The term 'short data sheet' is explained in section "Definitions".

[3] The product status of device(s) described in this document may have changed since this document was published and may differ in case of multiple devices. The latest product status information is available on the Internet at URL <http://www.nxp.com>.

### 11.2 Definitions

**Draft** — The document is a draft version only. The content is still under internal review and subject to formal approval, which may result in modifications or additions. NXP Semiconductors does not give any representations or warranties as to the accuracy or completeness of information included herein and shall have no liability for the consequences of use of such information.

**Short data sheet** — A short data sheet is an extract from a full data sheet with the same product type number(s) and title. A short data sheet is intended for quick reference only and should not be relied upon to contain detailed and full information. For detailed and full information see the relevant full data sheet, which is available on request via the local NXP Semiconductors sales office. In case of any inconsistency or conflict with the short data sheet, the full data sheet shall prevail.

### 11.3 Disclaimers

**General** — Information in this document is believed to be accurate and reliable. However, NXP Semiconductors does not give any representations or warranties, expressed or implied, as to the accuracy or completeness of such information and shall have no liability for the consequences of use of such information.

**Right to make changes** — NXP Semiconductors reserves the right to make changes to information published in this document, including without limitation specifications and product descriptions, at any time and without notice. This document supersedes and replaces all information supplied prior to the publication hereof.

**Suitability for use** — NXP Semiconductors products are not designed, authorized or warranted to be suitable for use in medical, military, aircraft, space or life support equipment, nor in applications where failure or malfunction of an NXP Semiconductors product can reasonably be expected to result in personal injury, death or severe property or environmental

damage. NXP Semiconductors accepts no liability for inclusion and/or use of NXP Semiconductors products in such equipment or applications and therefore such inclusion and/or use is at the customer's own risk.

**Applications** — Applications that are described herein for any of these products are for illustrative purposes only. NXP Semiconductors makes no representation or warranty that such applications will be suitable for the specified use without further testing or modification.

**Limiting values** — Stress above one or more limiting values (as defined in the Absolute Maximum Ratings System of IEC 60134) may cause permanent damage to the device. Limiting values are stress ratings only and operation of the device at these or any other conditions above those given in the Characteristics sections of this document is not implied. Exposure to limiting values for extended periods may affect device reliability.

**Terms and conditions of sale** — NXP Semiconductors products are sold subject to the general terms and conditions of commercial sale, as published at <http://www.nxp.com/profile/terms>, including those pertaining to warranty, intellectual property rights infringement and limitation of liability, unless explicitly otherwise agreed to in writing by NXP Semiconductors. In case of any inconsistency or conflict between information in this document and such terms and conditions, the latter will prevail.

**No offer to sell or license** — Nothing in this document may be interpreted or construed as an offer to sell products that is open for acceptance or the grant, conveyance or implication of any license under any copyrights, patents or other industrial or intellectual property rights.

**Export control** — This document as well as the item(s) described herein may be subject to export control regulations. Export might require a prior authorization from national authorities.

**Quick reference data** — The Quick reference data is an extract of the product data given in the Limiting values and Characteristics sections of this document, and as such is not complete, exhaustive or legally binding.

### 11.4 Trademarks

Notice: All referenced brands, product names, service names and trademarks are the property of their respective owners.

## 12. Contact information

For more information, please visit: <http://www.nxp.com>

For sales office addresses, please send an email to: [salesaddresses@nxp.com](mailto:salesaddresses@nxp.com)

**13. Contents**

**1 Product profile . . . . . 1**

1.1 General description. . . . . 1

1.2 Features . . . . . 1

1.3 Applications . . . . . 1

1.4 Quick reference data. . . . . 1

**2 Pinning information. . . . . 2**

**3 Ordering information. . . . . 2**

**4 Marking. . . . . 2**

**5 Limiting values. . . . . 3**

**6 Thermal characteristics. . . . . 4**

**7 Characteristics. . . . . 5**

**8 Package outline . . . . . 9**

**9 Soldering . . . . . 10**

**10 Revision history. . . . . 11**

**11 Legal information. . . . . 12**

11.1 Data sheet status . . . . . 12

11.2 Definitions . . . . . 12

11.3 Disclaimers . . . . . 12

11.4 Trademarks. . . . . 12

**12 Contact information. . . . . 12**

**13 Contents . . . . . 13**

Please be aware that important notices concerning this document and the product(s) described herein, have been included in section 'Legal information'.



© NXP B.V. 2009.

All rights reserved.

For more information, please visit: <http://www.nxp.com>

For sales office addresses, please send an email to: [salesaddresses@nxp.com](mailto:salesaddresses@nxp.com)

Date of release: 11 September 2009

Document identifier: 2N7002CK\_1