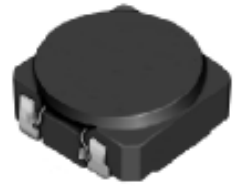
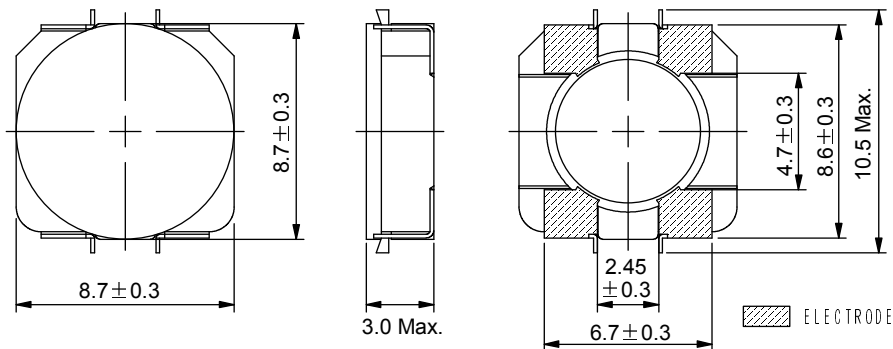
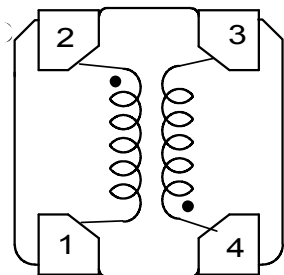

Type: CLS8D28
◆ Description

- 4 Terminal pins' type gives a flexible design as inductors or transformers.
- Can also be used as a coupled inductor, two single inductors connected in parallel, as 1:1 transformer or as an autotransformer when connected in series.
- Core material: Ferrite.
- Custom design is available.

◆ Feature

- Max. Operating frequency: 1MHz.
- 2 in 1 Coils for high efficiency up-down DC-DC converters.(SEPIC, Zeta, Cuk converter).
- Storage temperature range: -40°C~+105°C.
- Operating temperature range: -40°C~+105°C (including coil's self-heat).
- Product weight: 880mg(Ref.).
- Ideally used in the power supply for DSC、Note PC、DVC and W-LED backlighting.
- RoHS Compliance.

◆ Dimensions (mm)

◆ Schematics (Bottom)

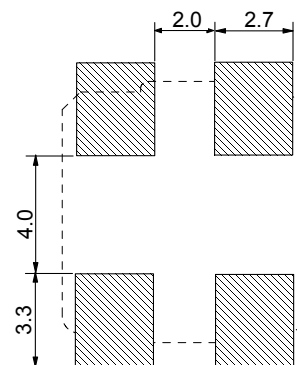
“●” indicates polarity.

◆ Land Pattern (mm)

Type: CLS8D28
◆ Specification

Part No.	Stamp	Inductance [Within]	D.C.R. [Max.] (mΩ) (at 20°C)※1		Saturation Current (A) ※2				Temperature Rise current (A) ※3	
			(2-1)	(4-3)	In parallel		In series		In parallel	In series
					at 20°C	at 100°C	at 20°C	at 100°C		
CLS8D28-1R0N□	1R0	1.0μH±30%	24(19)	26(21)	6.70	5.40	3.20	2.80	6.00	3.00
CLS8D28-1R6N□	1R6	1.6μH±30%	25(20)	30(24)	5.10	4.30	2.70	2.30	5.60	2.60
CLS8D28-2R2N□	2R2	2.2μH±30%	30(24)	35(28)	4.40	3.90	2.30	1.90	5.00	2.30
CLS8D28-3R3N□	3R3	3.3μH±30%	36(29)	43(34)	3.70	3.10	1.90	1.50	4.80	2.10
CLS8D28-4R5N□	4R5	4.5μH±30%	39(31)	48(38)	3.30	2.90	1.50	1.30	4.20	2.00
CLS8D28-6R8N□	6R8	6.8μH±30%	55(44)	70(56)	2.50	2.10	1.10	0.96	3.90	1.80
CLS8D28-100N□	100	10μH±30%	81(65)	99(79)	2.20	1.80	1.00	0.90	3.10	1.50
CLS8D28-150N□	150	15μH±30%	126(101)	161(129)	1.50	1.30	0.77	0.64	2.40	1.10
CLS8D28-220N□	220	22μH±30%	184(147)	235(188)	1.30	1.10	0.63	0.54	1.90	0.90
CLS8D28-330N□	330	33μH±30%	278(222)	355(284)	1.20	0.95	0.53	0.44	1.50	0.80
CLS8D28-470N□	470	47μH±30%	363(290)	464(371)	1.00	0.84	0.47	0.39	1.40	0.60
CLS8D28-680N□	680	68μH±30%	580(464)	736(589)	0.72	0.61	0.41	0.33	1.10	0.50
CLS8D28-101N□	101	100μH±30%	798(638)	1026(821)	0.58	0.51	0.31	0.28	0.92	0.40
CLS8D28-151N□	151	150μH±30%	1175(979)	1500(1251)	0.47	0.40	0.24	0.22	0.76	0.32
CLS8D28-221N□	221	220μH±30%	1720(1434)	2214(1845)	0.41	0.35	0.19	0.17	0.56	0.28

※ Description of Part Name

CLS8D28 -1R0N□

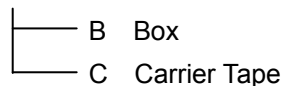

※1. () typical value.

※2. Saturation Current: The DC current at which the inductance decreases to 90% of it's nominal value.

 ※3. Temperature rise current: The DC current at which the temperature rise is $\Delta t=40^{\circ}\text{C}$. ($T_a=20^{\circ}\text{C}$).

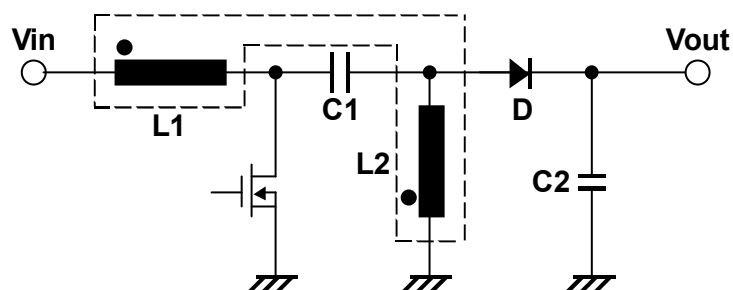
◆ Typical SEPIC Schematic

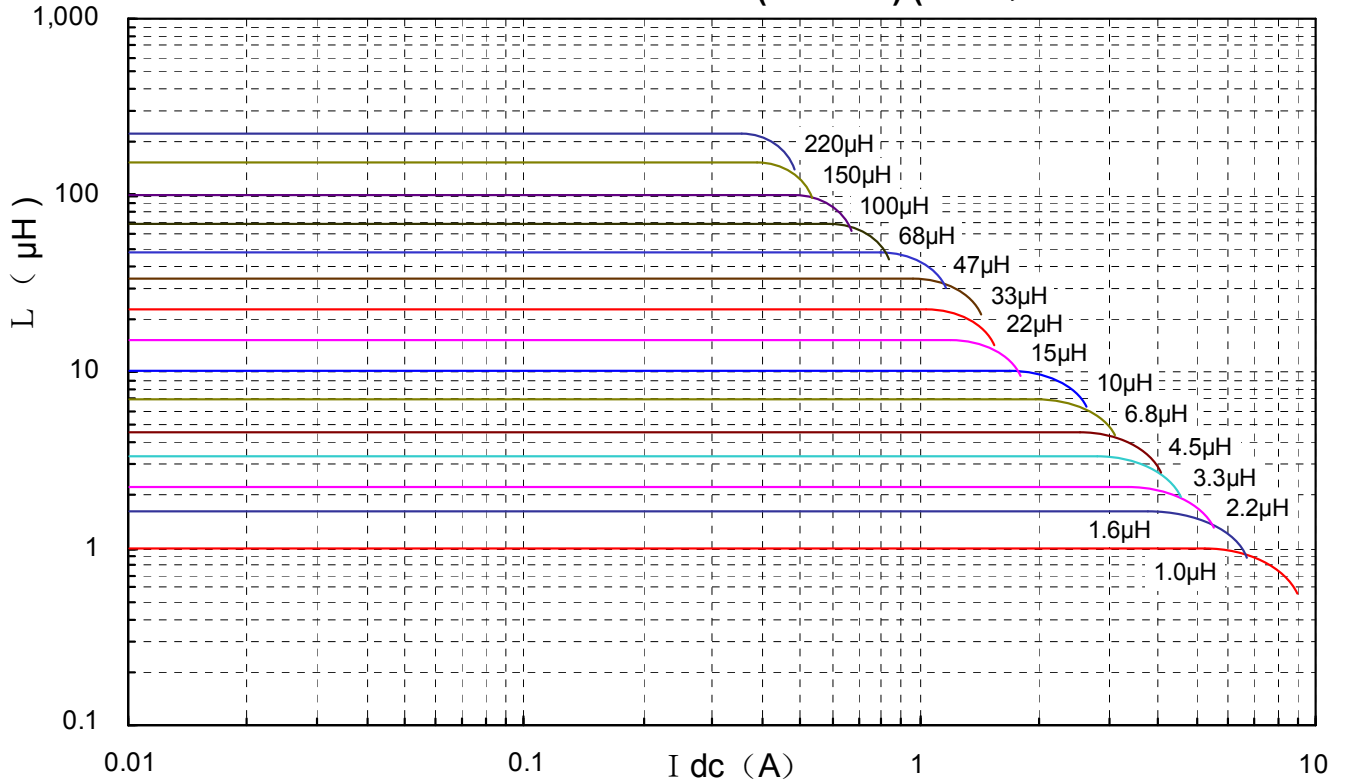
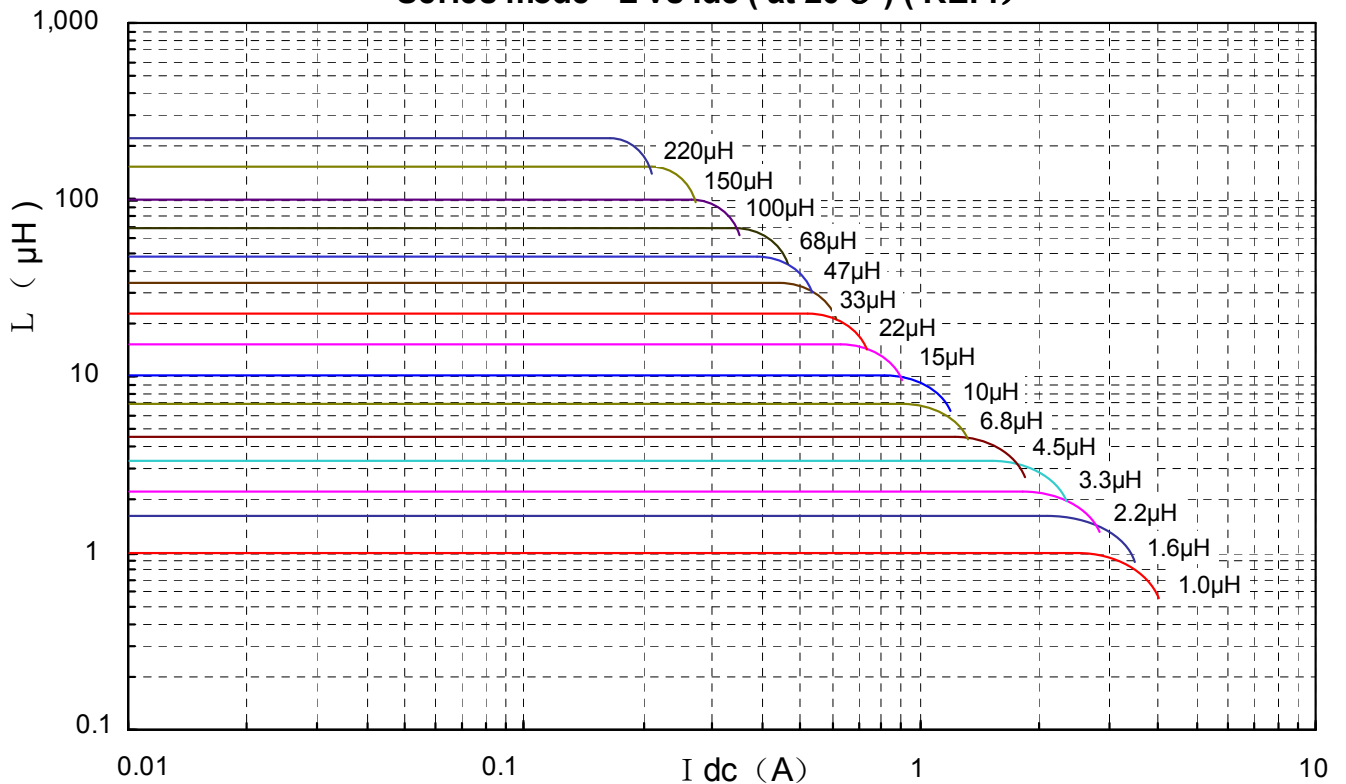
Type: CLS8D28
◆ Typical L Vs Current
Parallel mode L vs I_{dc} (at 20°C) (REF.)

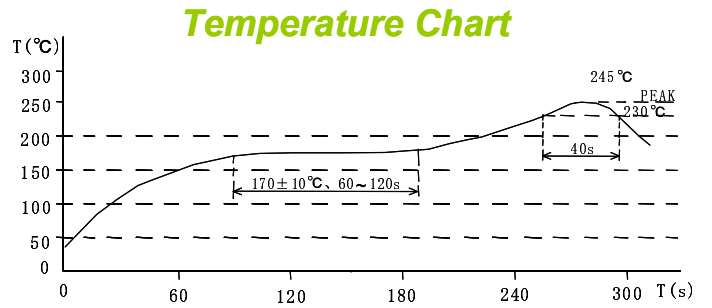
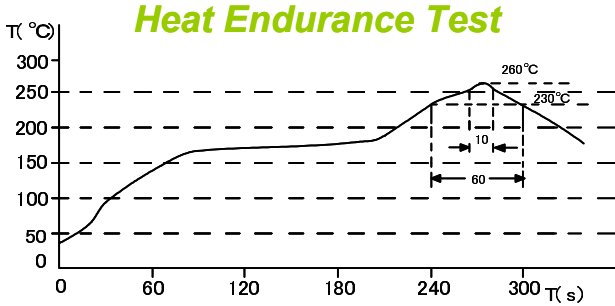
Series mode L vs I_{dc} (at 20°C) (REF.)

Type: CLS8D28
◆ Recommendation Reflow Condition

◆ Packaging with Embossed Tape and Reel
Qty.: 1000pcs/reel
