

45 Gbps, AND / NAND / OR / NOR w/ PROGRAMMABLE OUTPUT VOLTAGE



Typical Applications

The HMC843LC4B is ideal for:

- RF ATE Applications
- Broadband Test & Measurement
- Serial Data Transmission up to 45 Gbps
- Digital Logic Systems up to 25 GHz
- NRZ-to-RZ Conversion

Features

- Supports High Data Rates: up to 45 Gbps
- Differential & Single-Ended Operation
- Fast Rise and Fall Times: 10 / 10 ps
- Low Power Consumption: 530 mW
- Programmable Differential Output Voltage Swing: 200 - 900 mV
- Single Supply: -3.3V
- 24 Lead 4x4mm SMT Package: 16mm²

Functional Diagram

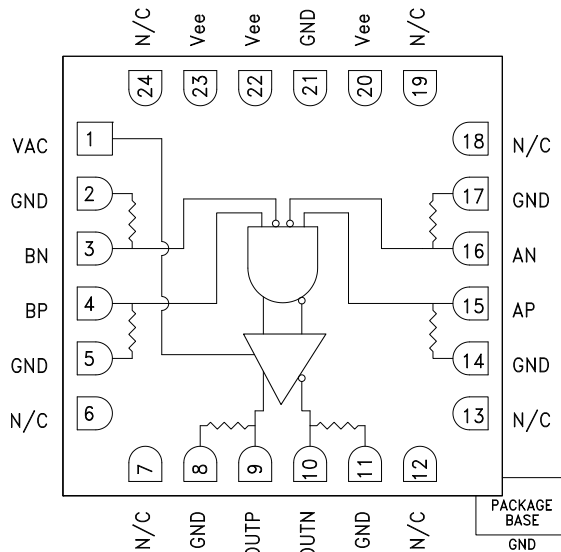

General Description

The HMC843LC4B is an AND/NAND/OR/NOR function designed to support data transmission rates of up to 45 Gbps, and clock frequencies as high as 25 GHz. The HMC843LC4B may be easily configured to provide any of the following logic functions:

AND, NAND, OR and NOR. The HMC843LC4B also features an output level control pin, VAC, which allows for loss compensation or for signal level optimization.

All input signals to the HMC843LC4B are terminated with 50 Ohms to ground on-chip, and may be either AC or DC coupled. The differential outputs of the HMC843LC4B may be either AC or DC coupled. Outputs can be connected directly to a 50 Ohms-to-ground terminated system, while DC blocking capacitors should be used if the terminating system is 50 Ohms to a non-ground DC voltage. The HMC843LC4B operates from a single -3.3V DC supply, and is available in a ceramic RoHS compliant 4x4 mm SMT package.

Electrical Specifications, $T_A = +25^\circ\text{C}$, $V_{ee} = -3.3\text{V}$

Parameter	Conditions	Min.	Typ.	Max	Units
Power Supply Voltage	$\pm 5\%$ Tolerance	-3.47	-3.3	-3.13	V
Power Supply Current	VAC = -0.4V	145	160	175	mA
Output Amplitude Control Voltage (VAC)		-1.7	-0.4	-0.1	V
Maximum Data Rate		45			Gbps
Maximum Clock Rate		25			GHz
Input Amplitude	Single-ended, peak-to-peak	100		300	mVp-p
	Differential, peak-to-peak	100		1000	
Input High Voltage		-0.5		0.5	V
Input Low Voltage		-1		0	V
Output Amplitude	Differential, peak-to-peak @ 40 Gbps	200		900	mVp-p

Information furnished by Analog Devices is believed to be accurate and reliable. However, no responsibility is assumed by Analog Devices for its use, nor for any infringements of patents or other rights of third parties that may result from its use. Specifications subject to change without notice. No license is granted by implication or otherwise under any patent or patent rights of Analog Devices. Trademarks and registered trademarks are the property of their respective owners.

For price, delivery, and to place orders: Analog Devices, Inc., One Technology Way, P.O. Box 9106, Norwood, MA 02062-9106
Phone: 781-329-4700 • Order online at www.analog.com
Application Support: Phone: 1-800-ANALOG-D

HMC843* PRODUCT PAGE QUICK LINKS

Last Content Update: 02/23/2017

COMPARABLE PARTS

View a parametric search of comparable parts.

EVALUATION KITS

- HMC843LC4B Evaluation Board

DOCUMENTATION

Data Sheet

- HMC843 Data Sheet

REFERENCE MATERIALS

Quality Documentation

- Package/Assembly Qualification Test Report: LC4, LC4B (QTR: 2014-00380 REV: 01)
- Semiconductor Qualification Test Report: BiCMOS-C (QTR: 2013-00241)

DESIGN RESOURCES

- HMC843 Material Declaration
- PCN-PDN Information
- Quality And Reliability
- Symbols and Footprints

DISCUSSIONS

View all HMC843 EngineerZone Discussions.

SAMPLE AND BUY

Visit the product page to see pricing options.

TECHNICAL SUPPORT

Submit a technical question or find your regional support number.

DOCUMENT FEEDBACK

Submit feedback for this data sheet.

**45 Gbps, AND / NAND / OR / NOR
w/ PROGRAMMABLE OUTPUT VOLTAGE**



Electrical Specifications, (continued)

Parameter	Conditions	Min.	Typ.	Max	Units
Output High Voltage		VAC = -0.3	-70		mV
Output Low Voltage		VAC = -0.3	-570		mV
Input Return Loss	Frequency < 25 GHz		10		dB
Output Return Loss	Frequency < 25 GHz		10		dB
Deterministic Jitter, Jd [1]			3		ps, pp
Additive Random Jitter Jr [2]			0.2		ps rms
Rise Time, tr [1]			10		ps
Fall Time, tf [1]			10		ps
Propagation Delay, td			10		ps

[1] A Input: 40 Gbps PRBS 2²³-1 pattern, 150 mVp-p single-ended, B Input: 40 Gbps 10101... pattern, 200 mVp-p single-ended
[2] Random jitter is measured with 40 Gbps 10101... pattern

DC Current vs. Supply Voltage [1] [2]

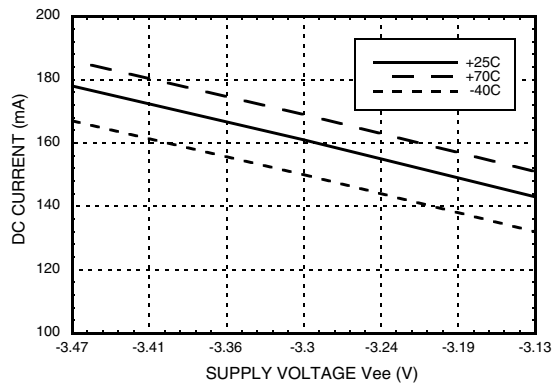

Differential Output Swing vs. Supply Voltage [1] [2]

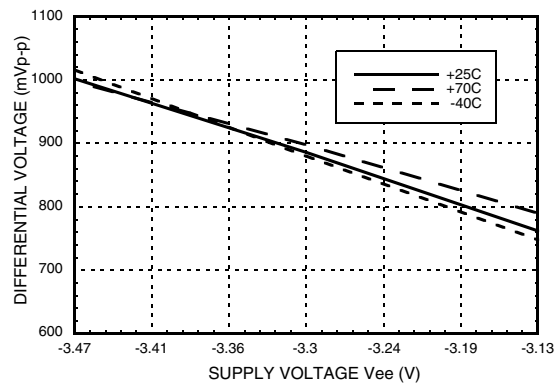

DC Current vs. VAC [2]

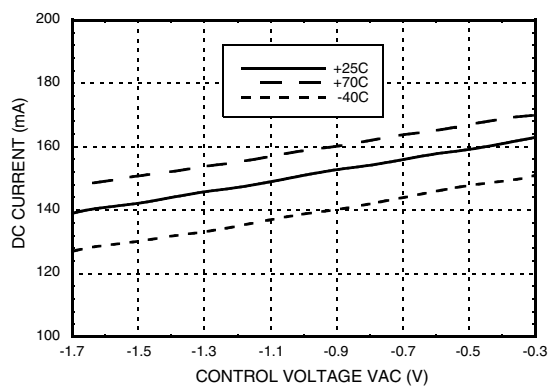

Differential Output Swing vs. VAC [2]

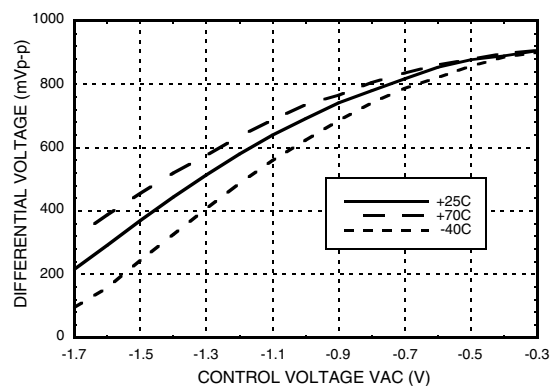

[1] VAC = -0.4V [2] Input data rate: 40 Gbps PRBS 2²³-1

Information furnished by Analog Devices is believed to be accurate and reliable. However, no responsibility is assumed by Analog Devices for its use, nor for any infringements of patents or other rights of third parties that may result from its use. Specifications subject to change without notice. No license is granted by implication or otherwise under any patent or patent rights of Analog Devices. Trademarks and registered trademarks are the property of their respective owners.

For price, delivery, and to place orders: Analog Devices, Inc., One Technology Way, P.O. Box 9106, Norwood, MA 02062-9106 Phone: 781-329-4700 • Order online at www.analog.com Application Support: Phone: 1-800-ANALOG-D

**45 Gbps, AND / NAND / OR / NOR
w/ PROGRAMMABLE OUTPUT VOLTAGE**



Rise Time vs. Supply Voltage [1][2][3]

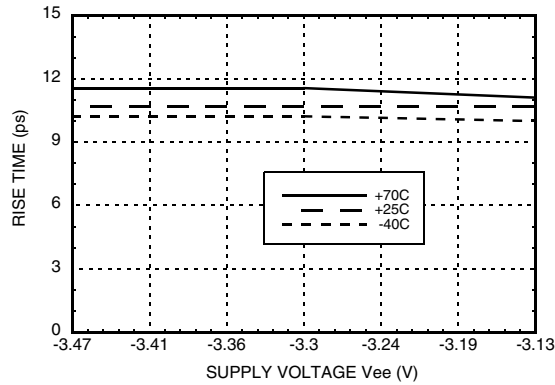

Fall Time vs. Supply Voltage [1][2][3]

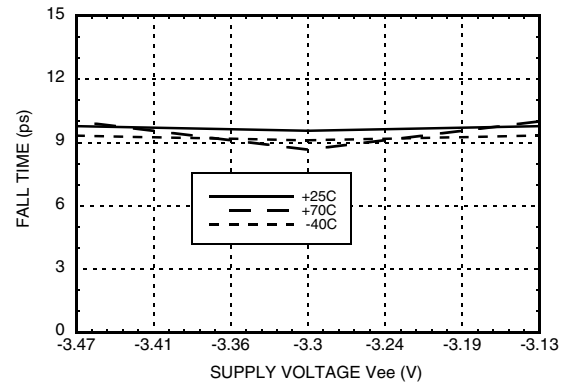

Rise / Fall Time vs. VAC [1][2][3]

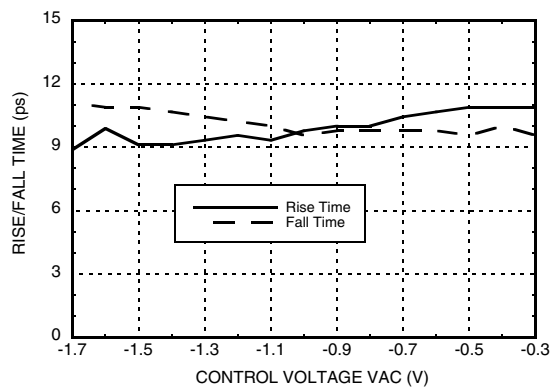

Peak-to-Peak Jitter vs. Supply Voltage [1][2][3][4]

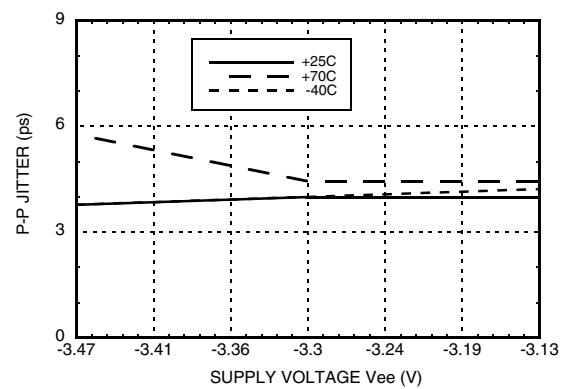

Input Return Loss vs. Frequency [1][5]

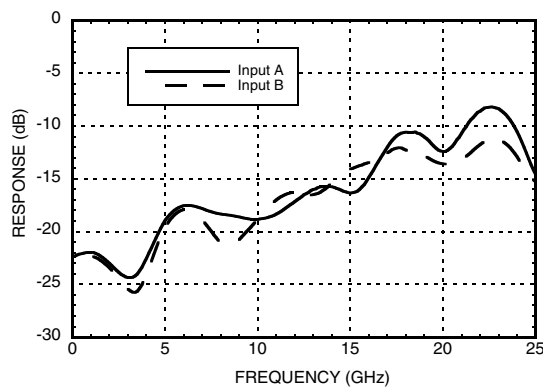

Output Return Loss vs. Frequency [1][5]

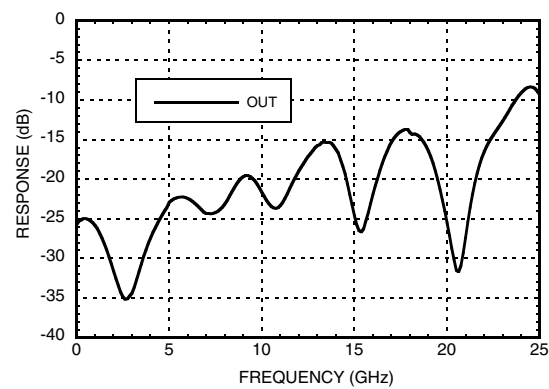

[1] VAC = -0.4V [2] Input data rate: 40 Gbps PRBS 2²³-1 [3] Data was taken at single ended output
[4] Source jitter was not deembedded [5] Device measured on evaluation board with single-ended time domain gating.

45 Gbps, AND / NAND / OR / NOR w/ PROGRAMMABLE OUTPUT VOLTAGE



40 Gbps RZ Differential Output Eye Diagram

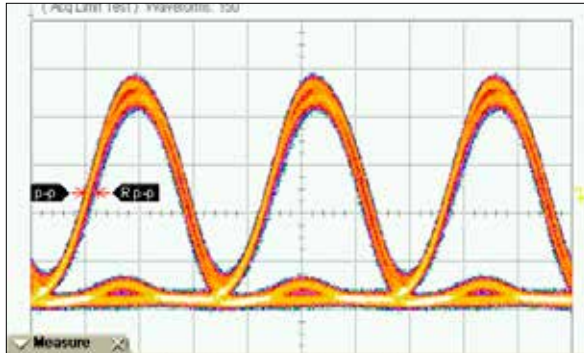

Measurements				
	Current	Min	Max	Total Meas.
Eye Amp	832 mV	830 mV	833 mV	48
Rise Time	10.67 ps	10.67 ps	10.67 ps	48
Fall Time	10.00 ps	9.67 ps	10.00 ps	48
p-p Jitter	3.667 ps	3.000 ps	3.667 ps	48

Time Scale: 10 ps/div
Amplitude Scale: 200 mV/div

Test Conditions:
Vee = -3.3V, VAC = -0.4V
A Input: 40 Gbps PRBS 2²³-1 pattern, 150 mVp-p single-ended
B Input: 40 Gbps 10101... pattern, 200 mVp-p single-ended

40 Gbps NRZ Differential Output Eye Diagram

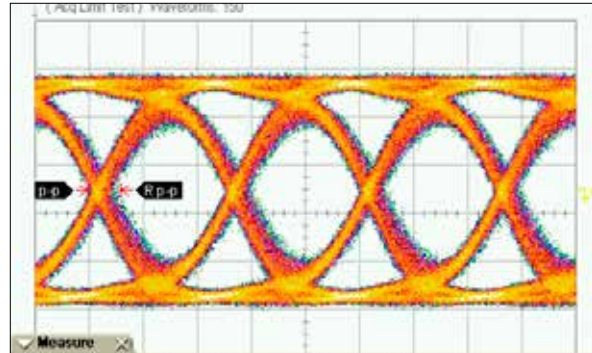

Measurements				
	Current	Min	Max	Total Meas.
Eye Amp	769 mV	768 mV	770 mV	48
Rise Time	14.00 ps	13.78 ps	14.22 ps	48
Fall Time	12.67 ps	12.22 ps	12.89 ps	48
p-p Jitter	6.000 ps	4.889 ps	6.000 ps	48

Time Scale: 10 ps/div
Amplitude Scale: 200 mV/div

Test Conditions:
Vee = -3.3V, VAC = -0.4V
A Input: 40 Gbps PRBS 2²³-1 pattern, 150 mVp-p single-ended
B Input: BP = 0V, BN = -0.3V

Timing Diagram

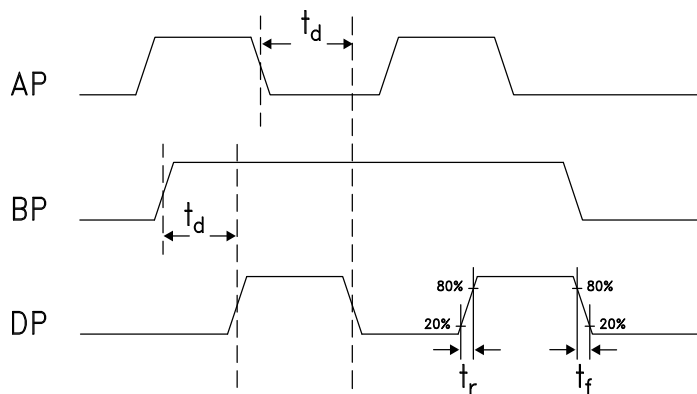

Truth Table

Input		Outputs
A	B	D
L	L	L
L	H	L
H	L	L
H	H	H

Notes:
A = AP - AN
B = BP - BN
D = DP - DN

H - Logic High
L - Logic Low

**45 Gbps, AND / NAND / OR / NOR
w/ PROGRAMMABLE OUTPUT VOLTAGE**



Absolute Maximum Ratings

Power Supply Voltage (Vee)	-3.7V to +0.5V
Input Voltage	-1.3V to +0.5V
Channel Temperature	125°C
Continuous Pdiss (T = 85°C) (derate 24.42 mW/°C above 85°C)	0.98 W
Thermal Resistance (channel to ground paddle)	40.95 °C/W
Storage Temperature	-65°C to +125°C
Operating Temperature	-40°C to +70°C
Output Amplitude Control Voltage (VAC)	-2.3V to +0.5V



**ELECTROSTATIC SENSITIVE DEVICE
OBSERVE HANDLING PRECAUTIONS**

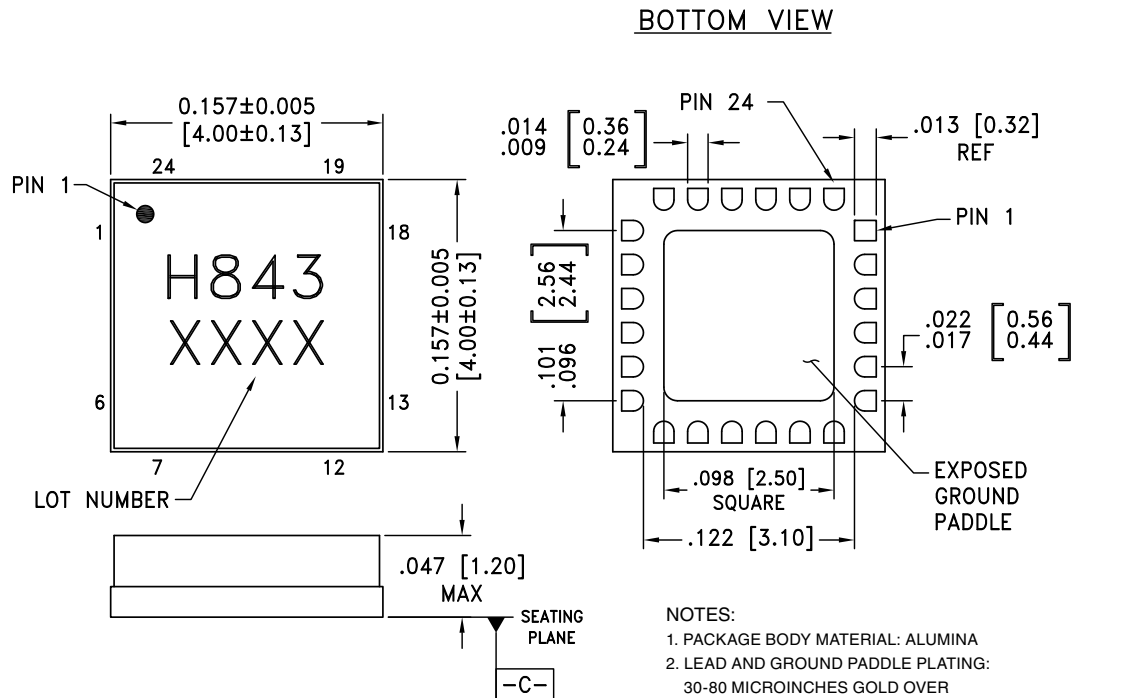

Outline Drawing



NOTES:

1. PACKAGE BODY MATERIAL: ALUMINA
2. LEAD AND GROUND PADDLE PLATING:
30-80 MICROINCHES GOLD OVER
50 MICROINCHES MINIMUM NICKEL.
3. DIMENSIONS ARE IN INCHES [MILLIMETERS].
4. LEAD SPACING TOLERANCE IS NON-CUMULATIVE.
5. PACKAGE WARP SHALL NOT EXCEED 0.05mm DATUM \square -C-
6. ALL GROUND LEADS AND GROUND PADDLE
MUST BE SOLDERED TO PCB RF GROUND.

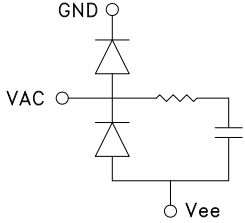
Pin Descriptions

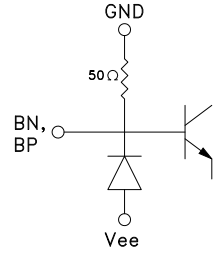
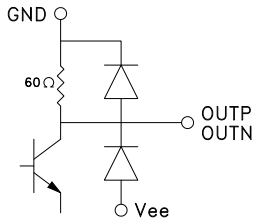
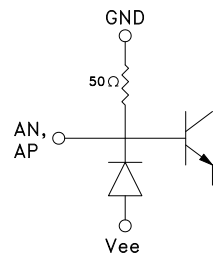
Pin Number	Function	Description	Interface Schematic
1	VAC	Output amplitude control voltage	
2, 5, 8, 11, 14, 17, 21 Package Base	GND	Signal and supply grounds	
3, 4	BN, BP	Differential (BP-BN) or single-ended (BP) data inputs	
6, 7, 12, 13, 18, 19, 24	N/C	The pins are not connected internally; however, all data shown herein was measured with these pins connected to RF/DC ground externally.	
9, 10	OUTP, OUTN	AND/OR/NAND/NOR outputs	
15, 16	AP, AN	Differential (AP-AN) or single-ended (AP) data inputs	
20, 22, 23	Vee	Power Supply (-3.3V)	



Evaluation PCB

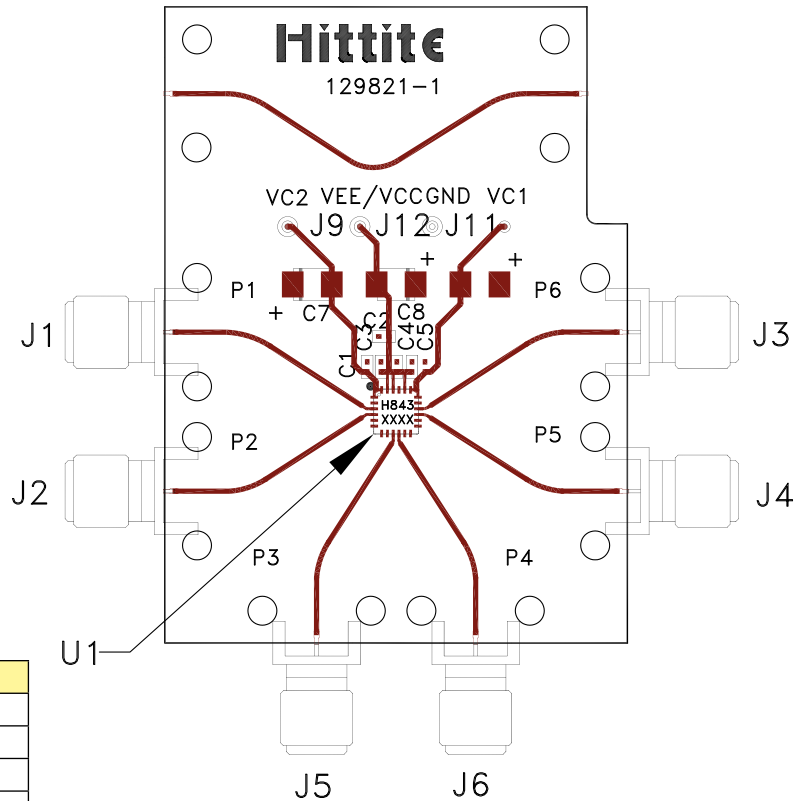

Item	Description
J1	BN
J2	BP
J3	AN
J4	AP
J5	OUTP
J6	OUTN
J9	VAC
J11	GND
J12	Vee

List of Materials for Evaluation PCB 129821 [1]

Item	Description
J1 - J6	K Connector
J9, J11, J12	DC Pin
C1, C3 - C5	1000pF Capacitor, 0402 Pkg.
C2	0.1 µF Capacitor, 0402 Pkg.
C7, C8	4.7 µF Capacitor, Tantalum
U1	HMC843LC4B AND / NAND / OR / NOR
PCB [2]	129821 Evaluation Board

[1] Reference this number when ordering complete evaluation PCB

[2] Circuit Board Material: Arlon 25FR or Rogers 4350

The circuit board used in the application should use RF circuit design techniques. Signal lines should have 50 Ohm impedance while the package ground leads should be connected directly to the ground plane similar to that shown. The exposed metal package base must be connected to Vee. A sufficient number of via holes should be used to connect the top and bottom ground planes. The evaluation circuit board shown is available from Hittite upon request.

**45 Gbps, AND / NAND / OR / NOR
w/ PROGRAMMABLE OUTPUT VOLTAGE**



Application Circuit

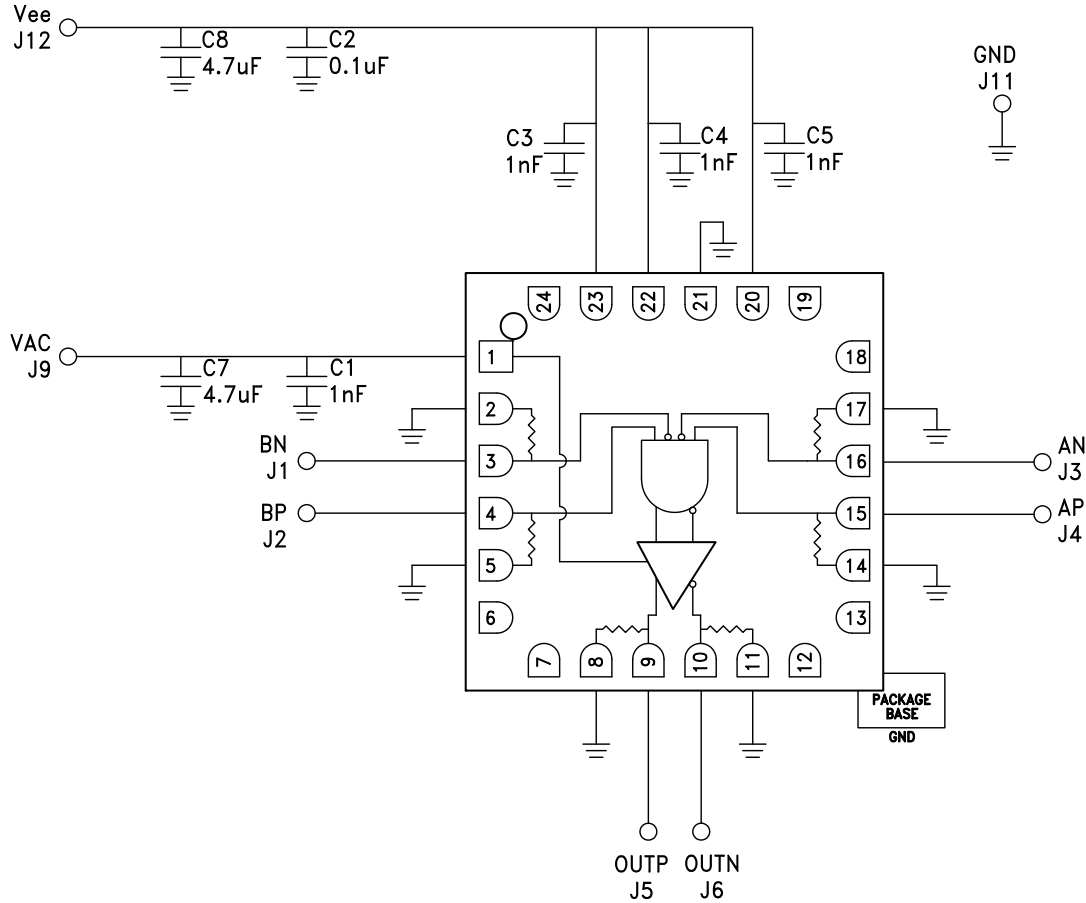

Information furnished by Analog Devices is believed to be accurate and reliable. However, no responsibility is assumed by Analog Devices for its use, nor for any infringements of patents or other rights of third parties that may result from its use. Specifications subject to change without notice. No license is granted by implication or otherwise under any patent or patent rights of Analog Devices. Trademarks and registered trademarks are the property of their respective owners.

For price, delivery, and to place orders: Analog Devices, Inc., One Technology Way, P.O. Box 9106, Norwood, MA 02062-9106 Phone: 781-329-4700 • Order online at www.analog.com Application Support: Phone: 1-800-ANALOG-D