

DO NOT SCALE FROM THIS PRINT

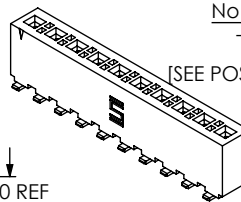
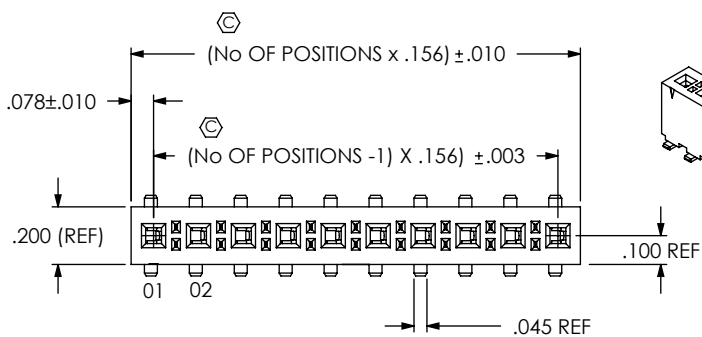

FHP-XX-XX-XX-S-XX-XX-XX

No OF POSITIONS  
-02 THRU -24  
(PER ROW)  
[SEE POSITIONAL FILL VIEW]  
LEAD STYLE  
-01: THROUGH HOLE  
(USE C-130-01-X)  
-02: SURFACE MOUNT  
(USE C-130-02-X)

\*POLARIZATION  
-02 THRU -06, -08, -10, -12, -13 & -14  
(SEE TABLE 1 FOR AVAILABLE COMBINATIONS)  
(SEE SHT 3, IN-PROCESS 1 POLARIZED FILL)  
(SEE NOTE 12)

OPTION  
-TR: TAPE & REEL PACKAGING  
(T&R AVAILABLE FOR 2 THRU 18 POS)  
(SEE NOTES 6 & 10)

OPTION  
-LC: LOCKING CLIP (USE LC-05-TM)  
(-02 LEAD STYLE ONLY, SEE NOTE 11)  
-A: ALIGNMENT PIN (USE FHP-XX-S-A)  
(SEE FIG 2) (-02 LEAD STYLE ONLY)  
-K: POLYIMIDE FILM PAD  
(SEE FIG 3, SHT. 2) (USE K-DOT-.256-.375-.005)  
(-02 LEAD STYLE ONLY)  
(AVAILABLE ON POSITIONS 2-24,  
2-4 POSITIONS MUST BE IN -TR)

ROW SPECIFICATION  
-S: SINGLE (USE FHP-XX-S)

PLATING SPECIFICATION  
-T: MATTE TIN CONTACT AND TAIL (USE C-130-XX-T)  
-TM: MATTE TIN CONTACT AND TAIL (USE C-130-XX-TM)  
-H: 30µ" GOLD IN CONTACT AREA,  
3µ" GOLD ON TAIL (USE C-130-XX-H)

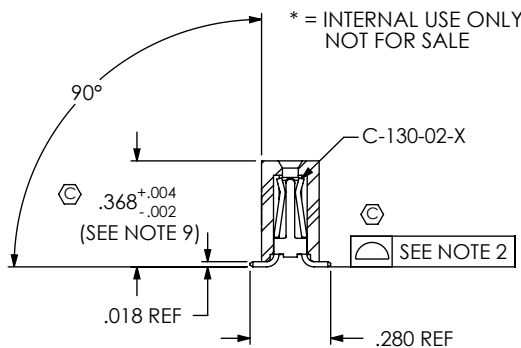
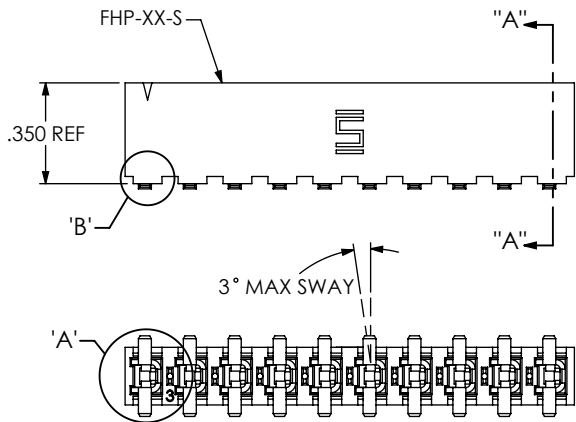

SECTION "A"-A"  
STYLE -02

FIG 1  
[FHP-10-02-X-S SHOWN]

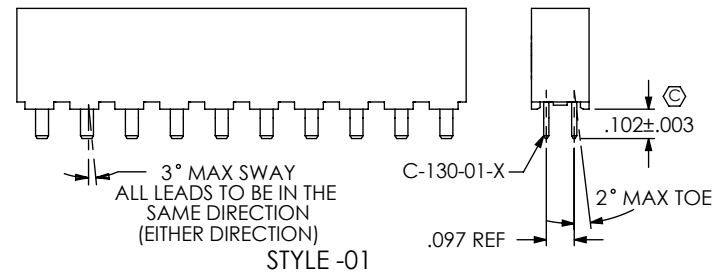

NOTES:

1. Ⓢ REPRESENTS A CRITICAL DIMENSION.
2. COPLANARITY TO BE WITHIN .006".
3. BURR ALLOWANCE: .0015 MAX.
4. MAXIMUM CUT FLASH: .020.
5. MINIMUM PUSHOUT FORCE: 1.0 LB.
6. LAYER PACKAGE STYLE -01 & -02, POSITIONS 02 - 04 WITH NO OPTIONS ONLY.
7. OPEN PART OF CONTACT FILLED TOWARDS # 1 PIN INDICATOR
8. MINIMUM WALL THICKNESS TO BE .010".
9. MEASURED @ BEND.
10. TUBE PACKAGING AVAILABLE FOR 5 THRU 24 POSITIONS.
11. DUE TO THE HIGH AMOUNT OF INSERTION FORCE NEEDED, THE -LC OPTION IS NOT COMPATIBLE WITH AUTO PLACEMENT. SAMTEC RECOMMENDS MANUAL PLACEMENT FOR ALL ASSEMBLIES WITH THE -LC OPTION.
12. POLARIZATION NUMBER INDICATES THE AMOUNT OF LIVE CONTACTS IN THE CONNECTOR.

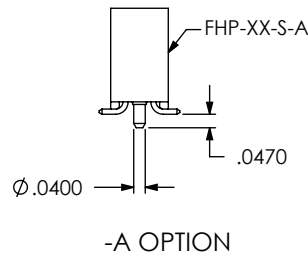
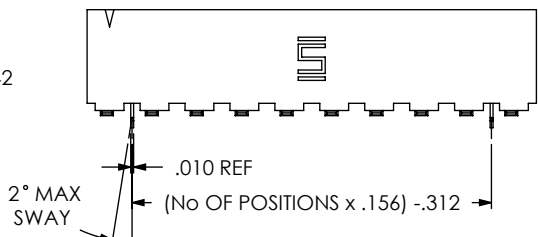
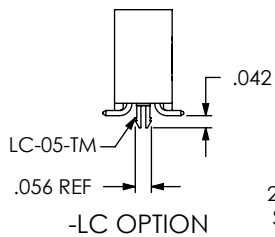

FIG 2

-LC & -A OPTIONS  
[-LC & -A OPTIONS ONLY AVAILABLE ON -02 LEAD STYLE]  
(SAME AS FIG 1, UNLESS OTHERWISE STATED)

TABLE 1

FINISHED GOODS	SUB ASSEMBLY
FHP-02-02-T-S-XX	FHP-24-02-T-S-02
FHP-02-01-T-S-XX	FHP-24-01-T-S-02
FHP-03-02-T-S-XX	FHP-24-02-T-S-03
FHP-04-01-T-S-XX	FHP-24-01-T-S-04
FHP-04-02-T-S-XX	FHP-24-02-T-S-04
FHP-05-02-T-S-XX	FHP-24-02-T-S-05
FHP-06-01-TM-S-XX / T-S-XX	FHP-24-01-T-S-06
FHP-08-01-T-S-XX	FHP-24-01-T-S-08
FHP-10-02-T-S-XX / TM-S-XX	FHP-24-02-T-S-10
FHP-12-02-T-S-XX	FHP-24-02-T-S-12
FHP-13-01-T-S-XX	FHP-24-01-T-S-13
FHP-14-01-T-S-XX	FHP-24-01-T-S-14
ALL REMAINING CONFIGURATIONS	FHP-24-XX-X-S

UNLESS OTHERWISE SPECIFIED, DIMENSIONS ARE IN INCHES.  
TOLERANCES ARE:  
DECIMALS ANGLES  
.XX: ±.01 2°  
.XXX: ±.005  
.XXXX: ±.0020

PROPRIETARY NOTE  
THIS DOCUMENT CONTAINS INFORMATION CONFIDENTIAL AND PROPRIETARY TO SAMTEC, INC. AND SHALL NOT BE REPRODUCED OR TRANSFERRED TO OTHER DOCUMENTS OR DISCLOSED TO OTHERS OR USED FOR ANY PURPOSE OTHER THAN THAT WHICH IT WAS OBTAINED WITHOUT THE EXPRESSED WRITTEN CONSENT OF SAMTEC, INC.



520 PARK EAST BLVD, NEW ALBANY, IN 47150  
PHONE: 812-944-6733 FAX: 812-948-5047  
e-Mail: info@SAMTEC.com code: 53322

MATERIAL: DO NOT SCALE DRAWING SHEET SCALE: 1.5:1  
MATERIAL: VECTRA E130i  
COLOR: BLACK  
CONTACT: BeCu, 174HT

DESCRIPTION:  
.156 HI POWER SOCKET ASSEMBLY

DWG. NO. FHP-XX-XX-XX-S-XX-XX-XX

BY: BRATCHER 03/01/99 SHEET 1 OF 3

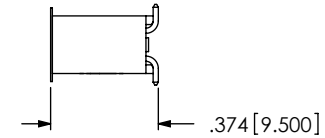
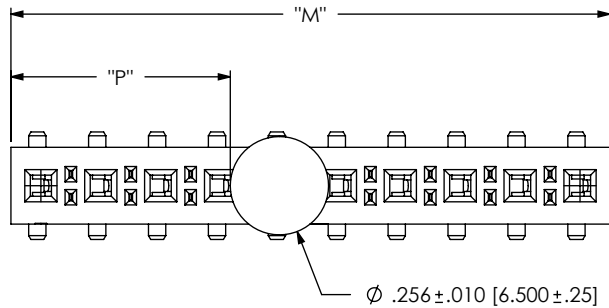

NOTE: "M" = USED MEASURED DIMENSION (REF)  
 "P" =  $\{("M" - .256 [6.50]) / 2\} \pm .020 [.51]$

FIG 3

-K: POLYIMIDE FILM PAD OPTION  
 (SHOWN: FHP-10-02-X-S-K)

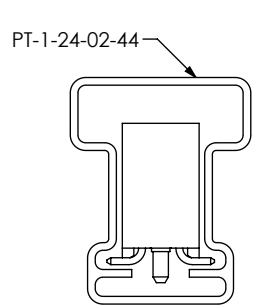

STYLE -02  
 (WITH ALIGNMENT PIN)

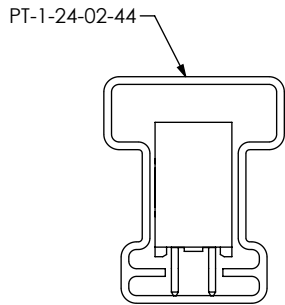

STYLE -01

(TUBE PACKAGING AVAILABLE FOR 5 THRU 24 POS)  
 (TUBE PACKAGE THE PARTS WITH #1 PIN TOWARDS ARROW)

PACKAGING TABLE

LEAD STYLE	OPTIONS	PACKAGING TUBE	PLUG
-01	ALL OPTIONS	PT-1-24-02-44	TP-03
-02	ALL OPTIONS	PT-1-24-02-44	TP-03

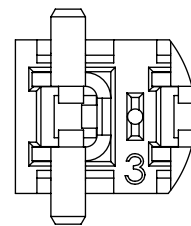

DETAIL 'A'  
 SCALE 4:1  
 (SHOWN FOR CONTACT ORIENTATION)

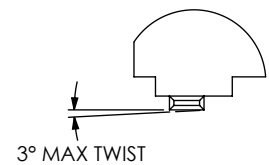

DETAIL 'B'  
 SCALE 4:1

F:\dwtg\sw\exisprod\assembly\156\FHP-XX-XX-XX-S-XX-XX-ASM.slddrw

**PROPRIETARY NOTE**  
 THIS DOCUMENT CONTAINS INFORMATION CONFIDENTIAL AND PROPRIETARY TO SAMTEC, INC. AND SHALL NOT BE REPRODUCED OR TRANSFERRED TO OTHER DOCUMENTS OR DISCLOSED TO OTHERS OR USED FOR ANY PURPOSE OTHER THAN THAT WHICH IT WAS OBTAINED WITHOUT THE EXPRESSED WRITTEN CONSENT OF SAMTEC, INC.

DO NOT SCALE DRAWING

SHEET SCALE: 1:0.666667



520 PARK EAST BLVD, NEW ALBANY, IN 47150  
 PHONE: 812-944-6733 FAX: 812-948-5047  
 e-Mail: info@SAMTEC.com code: 55322

DESCRIPTION:  
 .156 HI POWER SOCKET ASSEMBLY  
 DWG. NO.  
**FHP-XX-XX-XX-S-XX-XX-XX**  
 BY: BRATCHER 03/01/99 SHEET 2 OF 3

**POLARIZED OPTION**  
 ■ = DENOTES EMPTY POSITION

IN-PROCESS 1  
 FILL C-130-XX-X

**-02 POLARIZATION**  
 (8 FINISHED GOODS)  
 FHP-24-02-XX-S-02 SHOWN

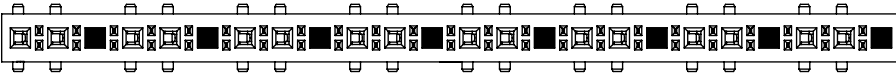

**-03 POLARIZATION**  
 (6 FINISHED GOODS)  
 FHP-24-02-XX-S-03 SHOWN

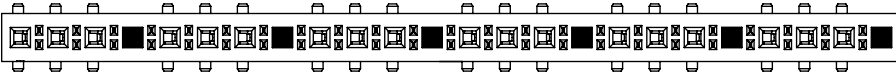

**-04 POLARIZATION**  
 (5 FINISHED GOODS)  
 FHP-24-02-XX-S-04 SHOWN

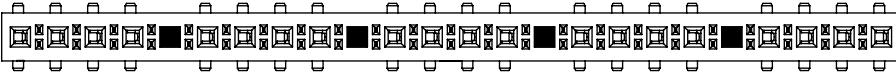

**-05 POLARIZATION**  
 (4 FINISHED GOODS)  
 FHP-24-02-XX-S-05 SHOWN

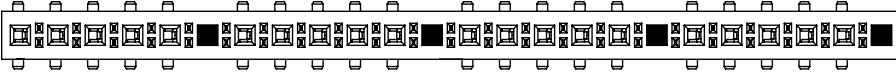

**-06 POLARIZATION**  
 (3 FINISHED GOODS)  
 FHP-24-01-XX-S-06 SHOWN



**-08 POLARIZATION**  
 (2 FINISHED GOODS)  
 FHP-24-01-XX-S-08 SHOWN



**-10 POLARIZATION**  
 (2 FINISHED GOODS)  
 FHP-24-02-XX-S-10 SHOWN

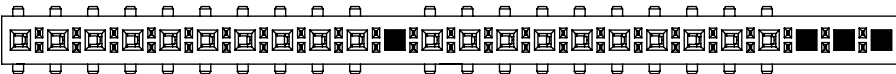

**STANDARD FILL**

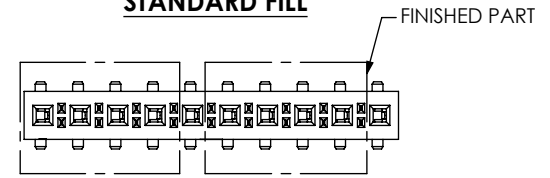

4 POSITION SHOWN  
 [PRIOR TO CUT-TO-POSITION OPERATION]

**-12 POLARIZATION**  
 (1 FINISHED GOODS)  
 FHP-24-02-XX-S-12 SHOWN

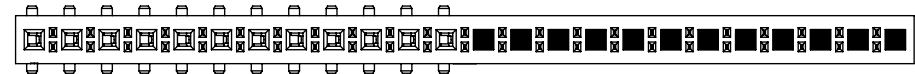

**-13 POLARIZATION**  
 (1 FINISHED GOODS)  
 FHP-24-01-XX-S-13 SHOWN

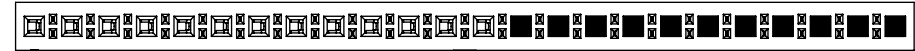

**-14 POLARIZATION**  
 (1 FINISHED GOODS)  
 FHP-24-01-XX-S-14 SHOWN

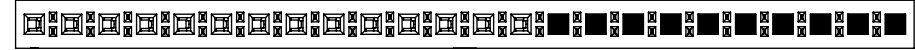

**PROPRIETARY NOTE**  
 THIS DOCUMENT CONTAINS INFORMATION  
 CONFIDENTIAL AND PROPRIETARY TO  
 SAMTEC, INC. AND SHALL NOT BE REPRODUCED  
 OR TRANSFERRED TO OTHER DOCUMENTS OR  
 DISCLOSED TO OTHERS OR USED FOR ANY  
 PURPOSE OTHER THAN THAT WHICH IT WAS  
 OBTAINED WITHOUT THE EXPRESSED WRITTEN  
 CONSENT OF SAMTEC, INC.

DO NOT SCALE DRAWING  
 SHEET SCALE: 1.25:1

**samtec**  
 520 PARK EAST BLVD, NEW ALBANY, IN 47150  
 PHONE: 812-944-6733 FAX: 812-948-5047  
 e-Mail: info@SAMTEC.com code: 55322

DESCRIPTION:  
 .156 HI POWER SOCKET ASSEMBLY  
 DWG. NO.  
**FHP-XX-XX-XX-S-XX-XX-XX**  
 BY: BRATCHER 03/01/99 SHEET 3 OF 3