

# IS31SE5100

## 8-CH CAPACITIVE TOUCH SENSOR WITH AUTO CALIBRATION

March 2013

### GENERAL DESCRIPTION

The IS31SE5100 is an ultra low power, fully integrated 8-channel solution for capacitive touch-buttons applications. The chip allows electrodes to project sense fields through any dielectric such as glass or plastic. On-chip calibration logic continuously monitors the environment and automatically adjusts on-and-off threshold levels to prevent false sensor activation.

The IS31SE5100 supports the 400kHz I<sup>2</sup>C serial bus data protocol and includes a field programmable slave address. An INTB is generated when a button event (touched or released) occurs, triggered and cleared condition could be configured by setting the interrupt register.

IS31SE5100 is available in QFN-24 (4mm × 4mm) and SSOP-24 packages. It operates from 2.7V to 5.5V over the temperature range of -40°C to +85°C.

### FEATURES

- Complete eight sensors capacitive touch controller for buttons
- Auto offset compensation
- Sensitivity adjustable by external capacitor or internal register
- Extremely low power optimized for portable application
- Interrupt output
- 400kHz fast-mode I<sup>2</sup>C interface
- 8kV ESD HBM
- Operating temperature  $T_A = -40^{\circ}\text{C} \sim +85^{\circ}\text{C}$
- QFN-24 (4mm × 4mm) and SSOP-24 packages

### APPLICATIONS

- Mobile phones
- GPS
- PDAs

### TYPICAL APPLICATION CIRCUIT

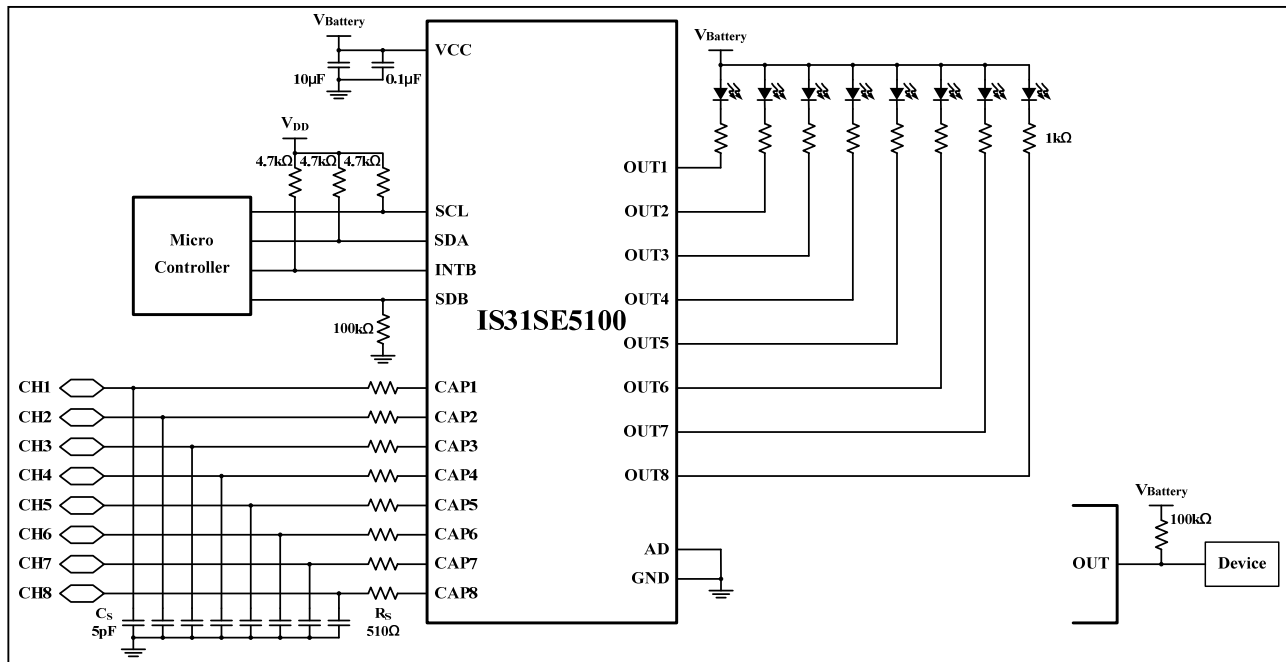

Figure 1 Typical Application Circuit

**Note 1:** The IC should be placed far away from the mobile antenna in order to prevent the EMI.

**Note 2:** The  $R_S$  resistor should place as close as possible to reduce EMI.

# IS31SE5100

## PIN CONFIGURATION

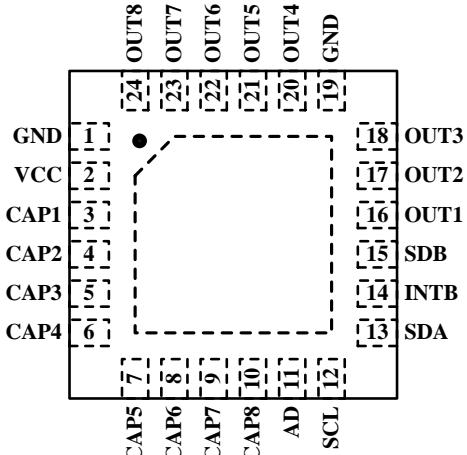
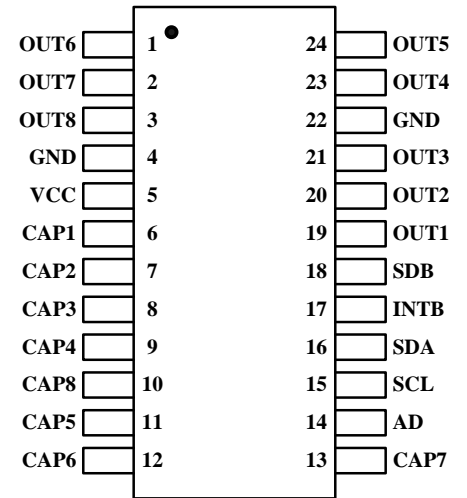
Package	Pin Configuration (Top View)
QFN-24	
SSOP-24	



# IS31SE5100

## PIN DESCRIPTION

No.		Pin	Description
QFN	SSOP		
1,19	4,22	GND	Ground.
2	5	VCC	Power supply.
3~10	6~9, 11~13,10	CAP1~CAP8	Input sense channel 1 ~ 8. Each channel should connect to GND if it is not used and disabled by the 01h register (Page 8).
11	14	AD	I2C address setting.
12	15	SCL	I2C serial clock.
13	16	SDA	I2C serial data.
14	17	INTB	Interrupt output, active low.
15	18	SDB	Shutdown the chip when pulled low.
16~18	19~21	OUT1~OUT3	Channel 1 ~ 3 outputs. Pull low when input sense channel is pressed. Each channel should be floating if it is not used.
20~24	23,24, 1~3	OUT4~OUT8	Channel 4 ~ 8 outputs. Pull low when input sense channel is pressed. Each channel should be floating if it is not used.
	-	Thermal Pad	Connect to GND.

Copyright © 2013 Integrated Silicon Solution, Inc. All rights reserved. ISSI reserves the right to make changes to this specification and its products at any time without notice. ISSI assumes no liability arising out of the application or use of any information, products or services described herein. Customers are advised to obtain the latest version of this device specification before relying on any published information and before placing orders for products. Integrated Silicon Solution, Inc. does not recommend the use of any of its products in life support applications where the failure or malfunction of the product can reasonably be expected to cause failure of the life support system or to significantly affect its safety or effectiveness. Products are not authorized for use in such applications unless Integrated Silicon Solution, Inc. receives written assurance to its satisfaction, that:

- a.) the risk of injury or damage has been minimized;
- b.) the user assume all such risks; and
- c.) potential liability of Integrated Silicon Solution, Inc is adequately protected under the circumstances



# IS31SE5100

## ORDERING INFORMATION

Industrial Range: -40°C to +85°C

---

Order Part No.	Package	QTY
IS31SE5100-QFLS2-TR	QFN-24, Lead-free	2500/Reel
IS31SE5100-SALS2	SSOP-24, Lead-free	58/Tube

---

# IS31SE5100

## ABSOLUTE MAXIMUM RATINGS

Supply voltage, $V_{CC}$	-0.3V ~ +6.0V
Voltage at any input pin	-0.3V ~ $V_{CC}+0.3V$
Maximum junction temperature, $T_{JMAX}$	150°C
Storage temperature range, $T_{STG}$	-65°C ~ +150°C
Operating temperature range, $T_A$	-40°C ~ +85°C

### Note:

Stresses beyond those listed under “Absolute Maximum Ratings” may cause permanent damage to the device. These are stress ratings only and functional operation of the device at these or any other condition beyond those indicated in the operational sections of the specifications is not implied. Exposure to absolute maximum rating conditions for extended periods may affect device reliability.

## ELECTRICAL CHARACTERISTICS

$T_A = 25^\circ\text{C}$ ,  $V_{CC} = 2.7\text{V} \sim 5.5\text{V}$ , unless otherwise noted. Typical value are  $T_A = 25^\circ\text{C}$ ,  $V_{CC} = 3.6\text{V}$ .

Symbol	Parameter	Condition	Min.	Typ.	Max.	Unit
$V_{CC}$	Supply voltage		2.7		5.5	V
$I_{CC}$	Quiescent power supply current	$V_{SDB} = V_{CC} = 3.6\text{V}$	11	175	345	$\mu\text{A}$
$I_{SD}$	Shutdown current	$V_{SDB} = 0\text{V}$ , $V_{CC} = 5.5\text{V}$	0	0.5	2.3	$\mu\text{A}$
$V_{HR}$	Current Sink headroom voltage	$I_{OUT} = 20\text{mA}$ , $V_{CC} = 3.6\text{V}$	218	312	412	mV
$\Delta C_S$	Minimum detectable capacitance	$C_S = 5\text{pF}$ (Note 1)		0.2		pF
<b>Logic Electrical Characteristics</b>						
$V_{IL}$	Logic “0” input voltage	$V_{CC} = 2.7\text{V}$			0.4	V
$V_{IH}$	Logic “1” input voltage	$V_{CC} = 5.5\text{V}$	1.4			V
$I_{IL}$	Logic “0” input current	$V_{INPUT} = 0\text{V}$ (Note 1)		5		nA
$I_{IH}$	Logic “1” input current	$V_{INPUT} = V_{CC}$ (Note 1)		5		nA

## DIGITAL INPUT SWITCHING CHARACTERISTICS (Note 1)

Symbol	Parameter	Condition	Min.	Typ.	Max.	Unit
$f_{SCL}$	Serial-Clock frequency				400	kHz
$t_{BUF}$	Bus free time between a STOP and a START condition		1.3			$\mu\text{s}$
$t_{HD, STA}$	Hold time (repeated) START condition		0.6			$\mu\text{s}$
$t_{SU, STA}$	Repeated START condition setup time		0.6			$\mu\text{s}$
$t_{SU, STO}$	STOP condition setup time		0.6			$\mu\text{s}$
$t_{HD, DAT}$	Data hold time				0.9	$\mu\text{s}$
$t_{SU, DAT}$	Data setup time		100			ns
$t_{LOW}$	SCL clock low period		1.3			$\mu\text{s}$
$t_{HIGH}$	SCL clock high period		0.7			$\mu\text{s}$
$t_R$	Rise time of both SDA and SCL signals, receiving	(Note 2)		$20+0.1C_b$	300	ns
$t_F$	Fall time of both SDA and SCL signals, receiving	(Note 2)		$20+0.1C_b$	300	ns

**Note 1:** Guaranteed by design.

**Note 2:**  $C_b$  = total capacitance of one bus line in pF.  $I_{SINK} \leq 6\text{mA}$ .  $t_R$  and  $t_F$  measured between  $0.3 \times V_{CC}$  and  $0.7 \times V_{CC}$ .

# IS31SE5100

## DETAILED DESCRIPTION

### I2C INTERFACE

The IS31SE5100 uses a serial bus, which conforms to the I2C protocol, to control the chip's functions with two wires: SCL and SDA. The IS31SE5100 has a 7-bit slave address (A7:A1), followed by the R/W bit, A0. Set A0 to "0" for a write command and set A0 to "1" for a read command. The value of bits A1 and A2 are decided by the connection of the AD pin.

The complete slave address is:

**Table 1 Slave Address**

Bit	A7:A3	A2:A1	A0
Value	10001	AD	1/0

AD connected to GND, AD = 00;  
 AD connected to VCC, AD = 11;  
 AD connected to SCL, AD = 01;  
 AD connected to SDA, AD = 10;

The SCL line is uni-directional. The SDA line is bi-directional (open-collector) with a pull-up resistor (typically 4.7kΩ). The maximum clock frequency specified by the I2C standard is 400kHz. In this discussion, the master is the microcontroller and the slave is the IS31SE5100.

The timing diagram for the I2C is shown in Figure 2. The SDA is latched in on the stable high level of the SCL. When there is no interface activity, the SDA line should be held high.

The "START" signal is generated by lowering the SDA signal while the SCL signal is high. The start signal will alert all devices attached to the I2C bus to check the incoming address against their own chip address.

The 8-bit chip address is sent next, most significant bit first. Each address bit must be stable while the SCL level is high.

After the last bit of the chip address is sent, the master checks for the IS31SE5100's acknowledge. The master releases the SDA line high (through a pull-up resistor). Then the master sends an SCL pulse. If the IS31SE5100 has received the address correctly, then it holds the SDA line low during the SCL pulse. If the SDA line is not low, then the master should send a "STOP" signal (discussed later) and abort the transfer.

Following acknowledge of IS31SE5100, the register address byte is sent, most significant bit first. IS31SE5100 must generate another acknowledge indicating that the register address has been received.

Then 8-bit of data byte are sent next, most significant bit first. Each data bit should be valid while the SCL level is stable high. After the data byte is sent, the IS31SE5100 must generate another acknowledge to indicate that the data was received.

The "STOP" signal ends the transfer. To signal "STOP", the SDA signal goes high while the SCL signal is high.

### READING PORT REGISTERS

To read the device data, the bus master must first send the IS31SE5100 address with the R/W bit set to "0", followed by the command byte, which determines which register is accessed. After a restart, the bus master must then send the IS31SE5100 address with the R/W bit set to "1". Data from the register defined by the command byte is then sent from the IS31SE5100 to the master (Figure 5).

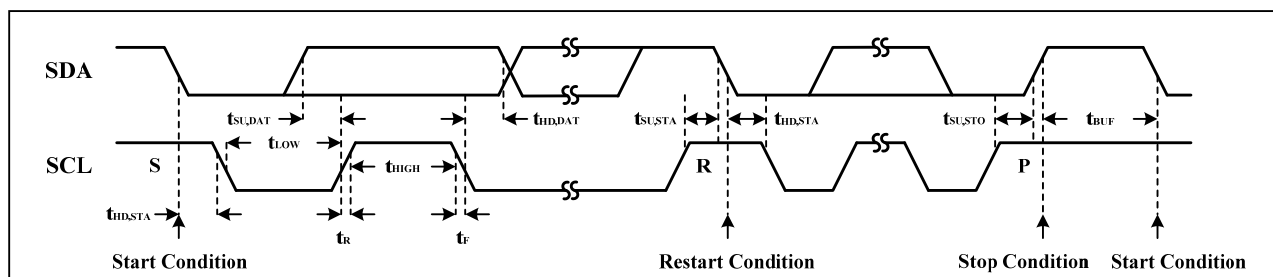

**Figure 2** Interface timing

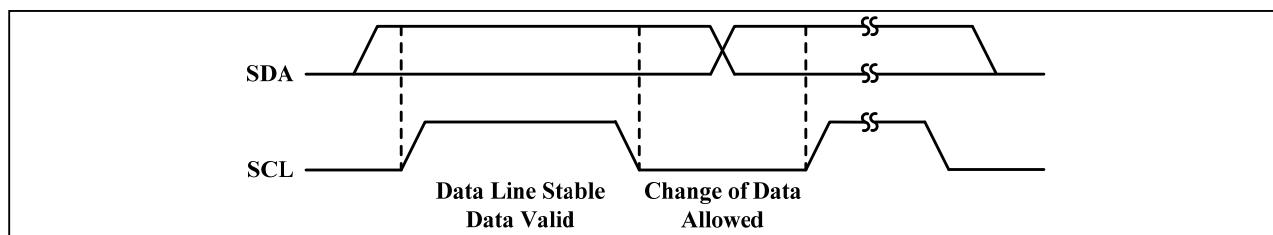

**Figure 3** Bit transfer

# IS31SE5100

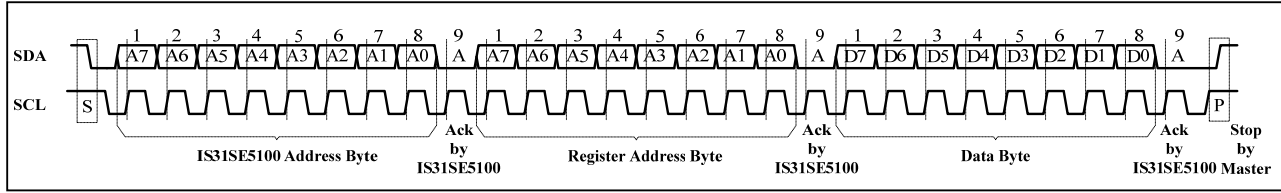

Figure 4 Writing to IS31SE5100

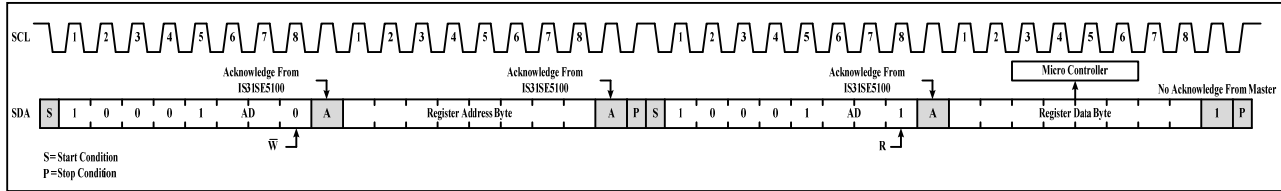

Figure 5 Reading from IS31SE5100

# IS31SE5100

**Table 2 Register Function**

Address	Name	Function	Table	Default
00h	Configuration Register	Set software shutdown mode and sensitivity	3	0000 0000
01h	Channel Control Register	Set the 8 channels enable	4	1111 1111
02h	State Register 1	Store state of action for 8 channels	5	0000 0000
03h	State Register 2	Show state of 8 channels changes or not	6	
04h	Interrupt Register	Set interrupt function	7	

**Table 3 00h Configuration Register**

Bit	D7	D6:D5	D4:D0
Name	SSD	SS	-
Default	0	00	00000

The Configuration Register sets software shutdown mode and sensitivity.

**SSD** Software Shutdown Enable  
 0 Normal operation  
 1 Software shutdown mode

**SS** Sensitivity Selection  
 00 Normal sensitivity  
 01 High sensitivity  
 10 Low sensitivity  
 11 Not a valid state

**Table 4 01h Channel Control Register**

Bit	D7:D0
Name	CH8: CH1
Default	1111 1111

The Channel Control Register sets the 8 channels enable.

**CHx** Channel Enable  
 0 Disable  
 1 Enable

**Table 5 02h State Register 1 (Read only)**

Bit	D7:D0
Name	AS8: AS1
Default	0000 0000

The State Register 1 stores state of action for 8 channels.

**ASx** Action State Bit  
 0 Button released  
 1 Button pressed

**Table 6 03h State Register 2 (Read only)**

Bit	D7:D1
Name	SC8: SC1
Default	0000 0000

The State Register 2 shows state of 8 channels changes or not.

**SCx** State Change Bit  
 0 No state change  
 1 Button touched or released event occurs

**Table 7 04h Interrupt Register**

Bit	D7:D6	D5:D0
Name	ACI	-
Default	00	000000

The Interrupt Register sets interrupt function.

**ACI** Automatically Clear Interrupt  
 00 No auto clear  
 01 Auto clear after 8ms  
 10 Auto clear after 32ms  
 11 Not a valid state



# IS31SE5100

## FUNCTIONAL BLOCK DIAGRAM

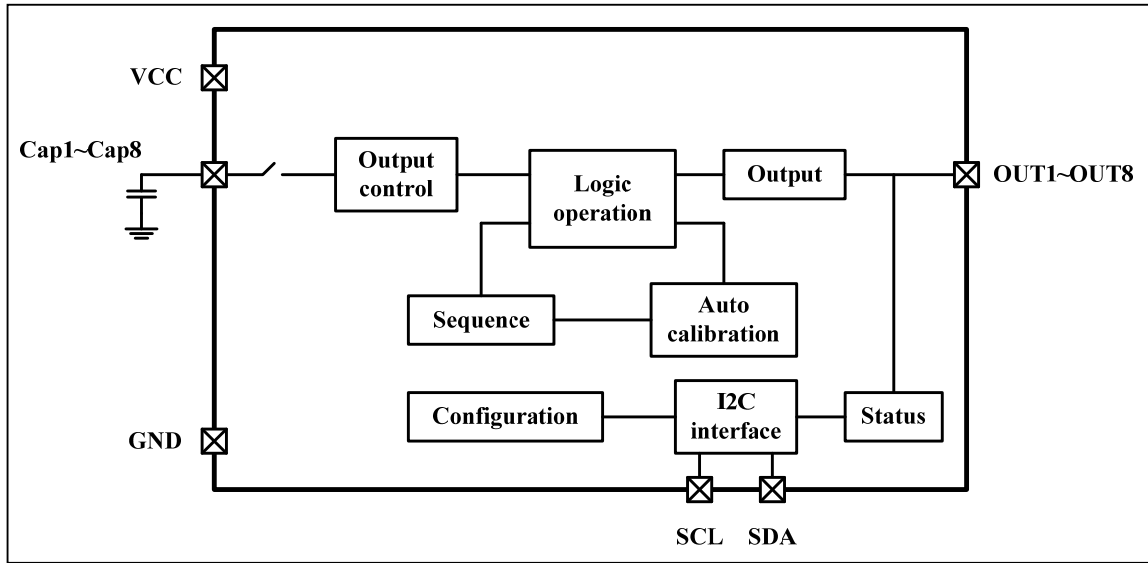

# IS31SE5100

## TYPICAL APPLICATION

### GENERAL DESCRIPTION

The IS31SE5100 is an ultra low power, fully integrated 8-channel solution for capacitive touch-buttons applications. The chip allows electrodes to project sense fields through any dielectric such as glass or plastic.

### SENSITIVITY ADJUSTING

Sensitivity can be adjusted by the external capacitor or internal register.

The value of capacitor is higher the sensitivity is lower; value of capacitor is lower the sensitivity is higher.

The SS bit of Configuration Register (00h) is used to modulate sensitivity. By setting the SS bit to "00" sensitivity is normal. Sensitivity is high when SS bit is set to "01". Sensitivity is low when SS bit is set to "10". Setting SS bit to "11" is not a valid state.

### OUTPUT CONTROL

There are 8 output ports for 8 sensitivity channels. The corresponding output will be pulled low to drive LED or other device if sensitivity channel is pressed.

For example, in Figure 1, when some sensitivity channels are pressed, the corresponding LEDs will be light up.

### ACTION INFORMATION

The action information is stored in the State Register (02h, 03h). If the AS bit is set to "0", the corresponding channel is released. If the AS bit is set to "1", the corresponding channels is pressed. If the SC bit is set to "0", the corresponding channel has no status changing. If the SC bit is set to "1", the corresponding channel has status changing.

### INTERRUPTION

The changing of action can be signed by the INTB pin. The INTB pin will be pulled low when sensitivity channel is pressed or released. And the MCU can get the information via reading the Status Register (02h, 03h). The INTB will be back to high until the MCU reading the Status Register 2 (03h).

The ACI bit of Interrupt Register (04h) is used to configure the automatically interrupt function. If the ACI bit is set to "00", the automatically interrupt function disable. If the ACI bit is set to "01", the function enable and the INTB pin will be high automatically when it stays low last 8ms. If the ACI bit is set to "10", the INTB pin will be high automatically when it stays low last 32ms. Setting ACI bit to "11" is not a valid state.

### SHUTDOWN MODE

Shutdown mode can be used as a means of reducing power consumption. During shutdown mode all registers retain their data.

### SOFTWARE SHUTDOWN

By setting SSD bit of the Configuration Register (00h) to "1", the IS31SE5100 will operate in software shutdown mode.

### HARDWARE SHUTDOWN

The chip enters hardware shutdown mode when the SDB pin is pulled low, wherein they consume only 0.5 $\mu$ A (typ.) current.

# IS31SE5100

## CLASSIFICATION REFLOW PROFILES

Profile Feature	Pb-Free Assembly
<b>Preheat &amp; Soak</b>	
Temperature min (T <sub>smin</sub> )	150°C
Temperature max (T <sub>smax</sub> )	200°C
Time (T <sub>smin</sub> to T <sub>smax</sub> ) (t <sub>s</sub> )	60-120 seconds
Average ramp-up rate (T <sub>smax</sub> to T <sub>p</sub> )	3°C/second max.
Liquidous temperature (TL)	217°C
Time at liquidous (t <sub>L</sub> )	60-150 seconds
Peak package body temperature (T <sub>p</sub> )*	Max 260°C
Time (t <sub>p</sub> )** within 5°C of the specified classification temperature (T <sub>c</sub> )	Max 30 seconds
Average ramp-down rate (T <sub>p</sub> to T <sub>smax</sub> )	6°C/second max.
Time 25°C to peak temperature	8 minutes max.

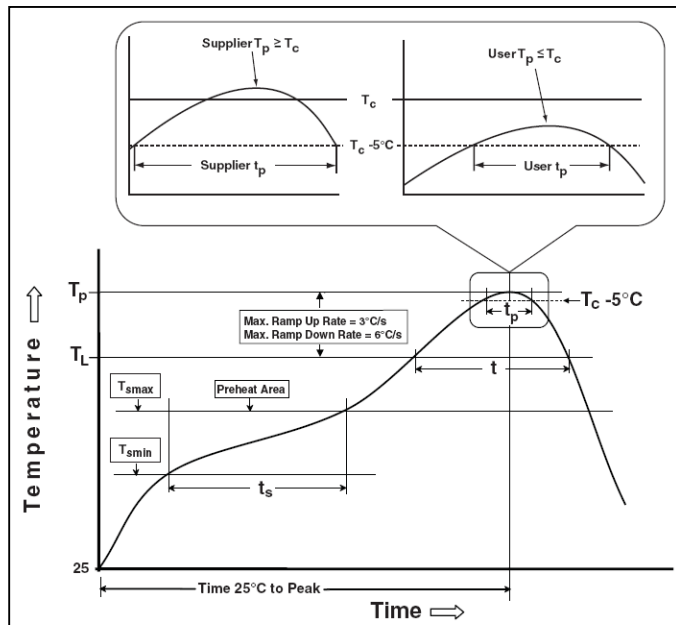
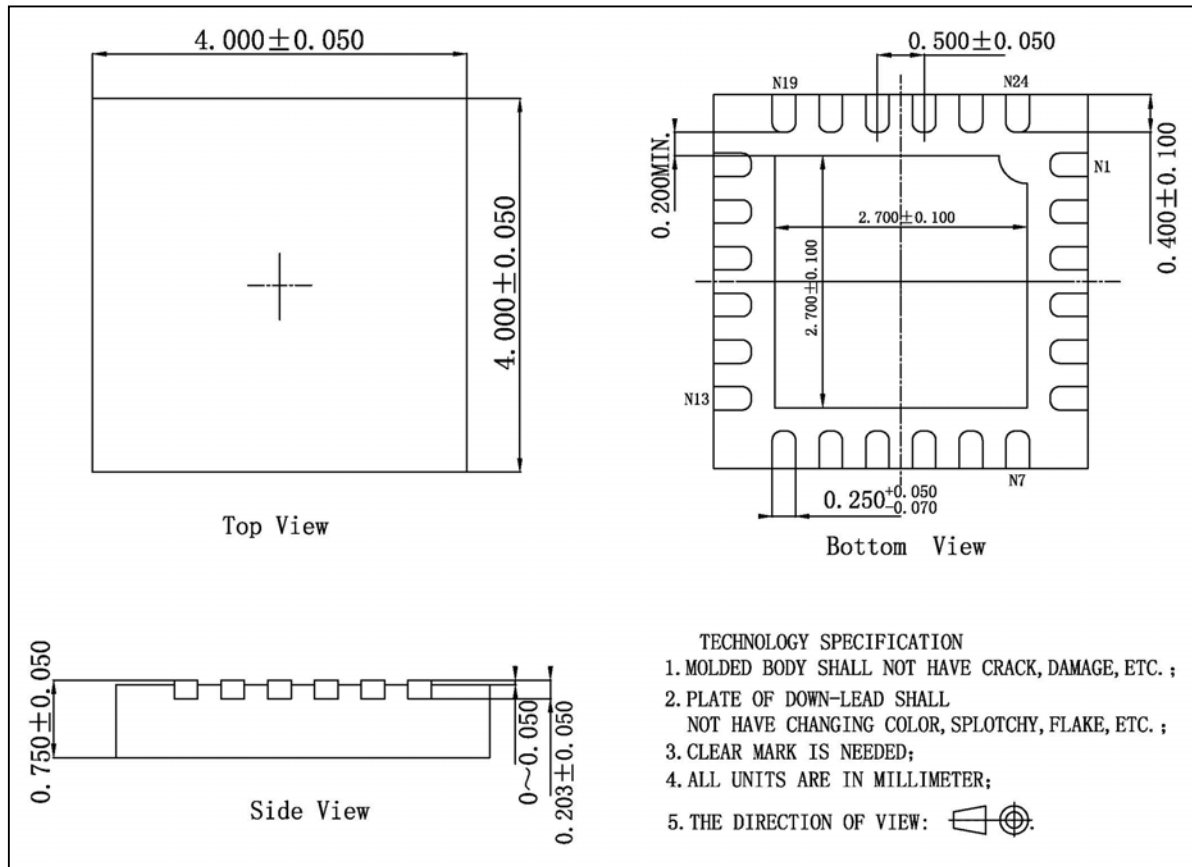

Figure 6 Classification profile

# IS31SE5100

## PACKAGE INFORMATION

### QFN-24



# IS31SE5100

## SSOP-24

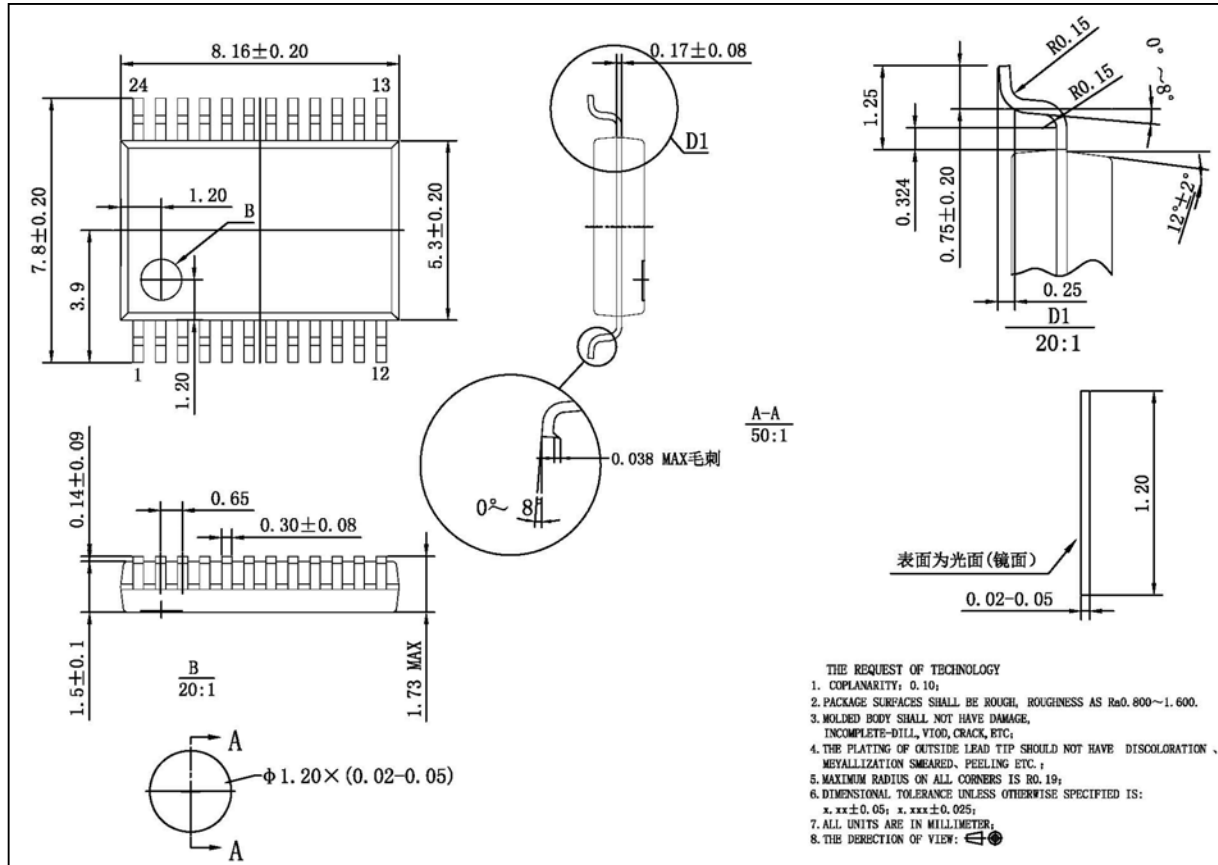

**Note:** All dimensions in millimeters unless otherwise stated.