

AC Power Transducer

DIN RAIL / PANEL MOUNT, ACTIVE / REACTIVE



CR Magnetics has a wide selection of Current and Potential Transformers to extend the range of any part.

The **CR6200** Series, Power Transducers and Transmitters are designed to provide a controlled output that is proportional to the average power. These devices are specifically targeted to provide an efficient solution to most power sensing needs. Units are designed for operation in systems with sinusoidal voltage and current wave forms.

Applications

- Energy Management
- Motor Efficiency
- Multi-point power sensing
- Remote power sensing over long distances

Features

- 35mm DIN Rail or Panel Mount
- Ranges available for any power sensing need
- Active and Reactive power sensing
- 0 - 5 VDC and 4 - 20 mA DC outputs
- Connection diagram printed on case

Regulatory Agencies

- Recognized to meet UL 61010B-1
- Constructed to meet CAN/CSA-C22.2, No. 61010-1-2004
- Meets requirement of IEC 61010-1 and BS EN 61010-1

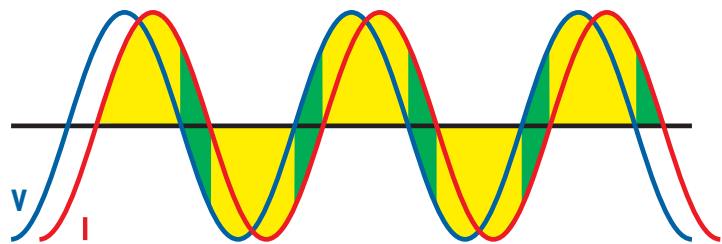

■ - ACTIVE POWER ■ - REACTIVE POWER

POWER TRANSDUCERS CAN BE ORDERED TO MEASURE ACTIVE OR REACTIVE POWER

DIN RAIL / PANEL MOUNT, ACTIVE / REACTIVE

Add suffix for input range

PART NUMBERS				
CR6210	-	-	-	1 Phase, Active Power with 0 - 5 VDC Output
CR6211	-	-	-	1 Phase, Reactive Power with 0 - 5 VDC Output
CR6220	-	-	-	1 Phase, Active Power with 4 - 20 mADC Output
CR6221	-	-	-	1 Phase, Reactive Power with 4 - 20 mADC Output
CR6230	-	-	-	2-Phase, 3-Wire, Active Power with 0 - 5 VDC Output
CR6231	-	-	-	2-Phase, 3-Wire, Reactive Power with 0 - 5 VDC Output
CR6240	-	-	-	2-Phase, 3-Wire, Active Power with 4 - 20 mADC Output
CR6241	-	-	-	2-Phase, 3-Wire, Reactive Power with 4 - 20 mADC Output
CR6250	-	-	-	3-Phase, 4-Wire, Active Power with 0 - 5 VDC Output
CR6251	-	-	-	3-Phase, 4-Wire, Reactive Power with 0 - 5 VDC Output
CR6260	-	-	-	3-Phase, 4-Wire, Active Power with 4 - 20 mADC Output
CR6261	-	-	-	3-Phase, 4-Wire, Reactive Power with 4 - 20 mADC Output

<input type="text"/>	-	<input type="text"/>
150	-	0-1.50 VAC
250	-	0-2.50 VAC
500	-	0-500 VAC *
Custom ranges available * not UL recognized		
5	-	0-5 AAC
25	-	0-25 AAC

CR Magnetics has a wide selection of current and potential transformers to extend the range of any part.

SPECIFICATIONS

Basic Accuracy:.....	0.5%
Linearity:.....	10% to 100% FS
Thermal Drift:.....	500 PPM/°C
Operating Temperature:.....	0°C to +60°C
Installation Category:.....	CAT II
Vibration Tested To:.....	IEC 60068-2-6,1995
Pollution Degree:.....	2
Response Time:	250 ms max. 0-90% FS
Supply Voltage:.....	12 to 24 VDC
MTBF:.....	Greater than 100 K hours
Frequency Range:.....	50 Hz - 400 Hz, sine wave
Insulation Voltage:.....	2500 VDC
Altitude:.....	2000 meter max. Output
Load:.....	4-20 mADC -0 to 300 Ω 0-5 VDC - 2K Ω or Greater

Cleaning:.....	Water-dampened cloth
Relative Humidity:...	80% for temperatures up to 31°C and decreasing linearly to 50% at 40°C

Supply Current:		
CR6210:.....	Typical 35mA	Max 45mA
CR6220:.....	Typical 75mA	Max 110mA
CR6230:.....	Typical 50mA	Max 70mA
CR6240:.....	Typical 75mA	Max 110mA
CR6250:.....	Typical 50mA	Max 70mA
CR6260:.....	Typical 75mA	Max 120mA
Torque Specs:.....	3.0 inch lbs. (0.4Nm)	
Weight:.....	0.5 lbs.	

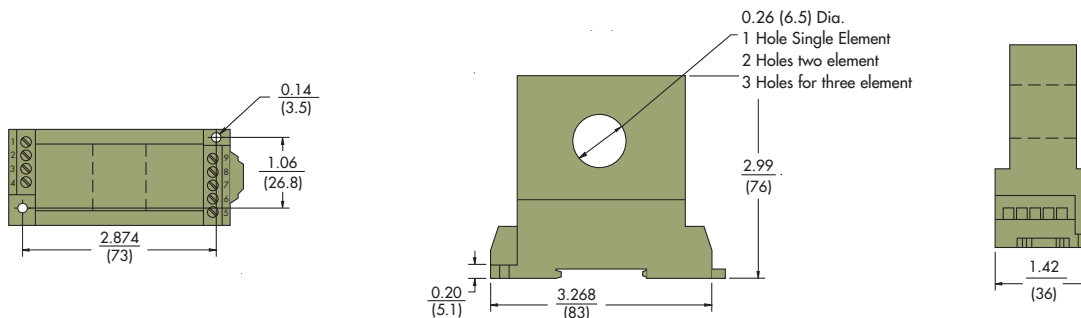

OUTLINE DRAWING

NOTE: The building installation must have a switch or circuit-breaker that is in close proximity and within easy reach of the operator. The switch or circuit breaker shall be marked as the disconnecting device for the equipment.

DIN RAIL / PANEL MOUNT, AVERAGE SENSING

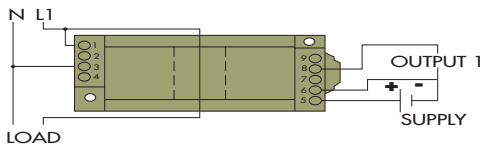

CR6210 CR6211
Single element, 0 - 5 VDC Output

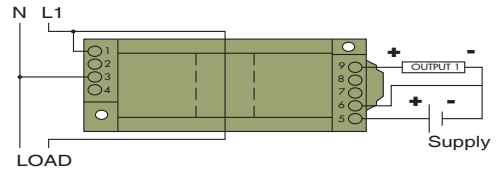

CR6220 CR6221
Single element, 4 - 20 mADC Output

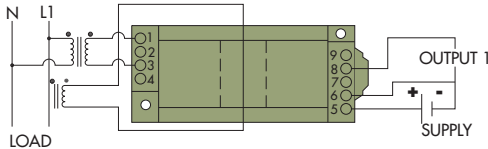

CR6210 CR6211
Single element, 0 - 5 VDC Output
with external voltage transformers

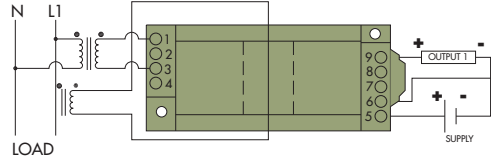

CR6220 CR6221
Single element, 4 - 20 mADC Output
with external voltage transformers

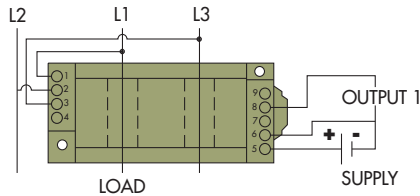

CR6230 CR6231
2 element - 3 Wire, 0 - 5 VDC Output

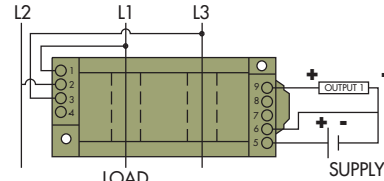

CR6240 CR6241
2 element - 3 Wire, 4 - 20 mADC output

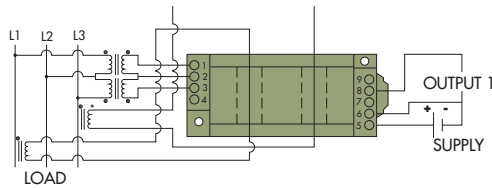

CR6230 CR6231
2 element - 3 Wire, 0 - 5 VDC Output
shown with external voltage and current transformers

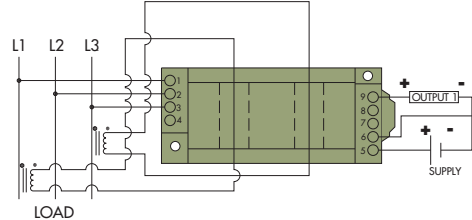

CR6240 CR6241
2 element - 3 Wire, 4 - 20 mADC Output
shown with external current transformer

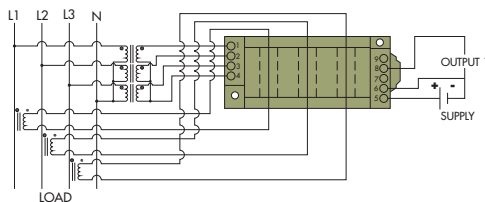

CR6250 CR6251
3 element - 4 Wire, 0 - 5 VDC Output
shown with external voltage and current transformers

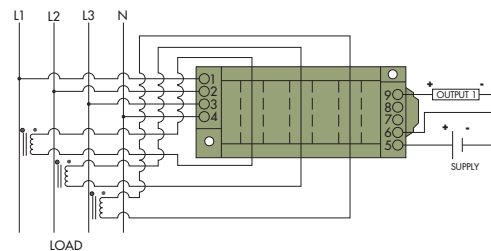

CR6260 CR6261
3 element - 4 Wire, 4 - 20 mADC Output
shown with external current transformers

CONNECTION DIAGRAMS