

## SuperSOT4™ DUAL 20V NPN SILICON LOW SATURATION SWITCHING TRANSISTOR

### SUMMARY

$V_{CE0} = 20V$ ;  $R_{SAT} = 40m\Omega$ ;  $I_C = 3.5A$

### DESCRIPTION

This new 4th generation ultra low saturation transistor utilises the Zetex matrix structure combined with advanced assembly techniques to give extremely low on state losses. This makes it ideal for high efficiency, low voltage switching applications.



**MSOP8**

### FEATURES

- Extremely Low Equivalent On Resistance
- Extremely Low Saturation Voltage
- $h_{FE}$  characterised up to 10A
- $I_C = 3.5A$  Continuous Collector Current
- MSOP8 package

### APPLICATIONS

- DC - DC Converters
- Power Management Functions
- Power switches
- Motor control

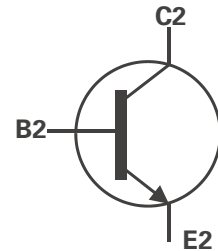
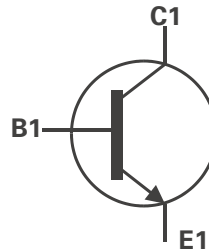

### ORDERING INFORMATION

| DEVICE       | REEL SIZE (inches) | TAPE WIDTH (mm) | QUANTITY PER REEL |
|--------------|--------------------|-----------------|-------------------|
| ZXT12N20DXTA | 7                  | 12mm embossed   | 1000 units        |
| ZXT12N20DXTC | 13                 | 12mm embossed   | 4000 units        |

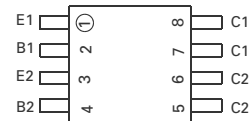

Top View

### DEVICE MARKING

T12N20DX

# ZXT12N20DX

## ABSOLUTE MAXIMUM RATINGS.

| PARAMETER  | SYMBOL        | LIMIT       | UNIT                        |
|--|---------------|-------------|-----------------------------|
| Collector-Base Voltage   | $V_{CBO}$     | 50          | V                           |
| Collector-Emitter Voltage  | $V_{CEO}$     | 20          | V                           |
| Emitter-Base Voltage   | $V_{EBO}$     | 7.5         | V                           |
| Peak Pulse Current   | $I_{CM}$      | 15          | A                           |
| Continuous Collector Current   | $I_C$         | 3.5         | A                           |
| Base Current   | $I_B$         | 500         | mA                          |
| Power Dissipation at $T_A=25^{\circ}\text{C}$ (a)(d)<br>Linear Derating Factor | $P_D$         | 0.87<br>6.9 | W<br>mW/ $^{\circ}\text{C}$ |
| Power Dissipation at $T_A=25^{\circ}\text{C}$ (a)(e)<br>Linear Derating Factor | $P_D$         | 1.04<br>8.3 | W<br>mW/ $^{\circ}\text{C}$ |
| Power Dissipation at $T_A=25^{\circ}\text{C}$ (b)(d)<br>Linear Derating Factor | $P_D$         | 1.25<br>10  | W<br>mW/ $^{\circ}\text{C}$ |
| Operating and Storage Temperature Range  | $T_j:T_{stg}$ | -55 to +150 | $^{\circ}\text{C}$          |

## THERMAL RESISTANCE

| PARAMETER                  | SYMBOL          | VALUE | UNIT                        |
|----------------------------|-----------------|-------|-----------------------------|
| Junction to Ambient (a)(d) | $R_{\theta JA}$ | 143   | $^{\circ}\text{C}/\text{W}$ |
| Junction to Ambient (b)(d) | $R_{\theta JA}$ | 100   | $^{\circ}\text{C}/\text{W}$ |
| Junction to Ambient (a)(e) | $R_{\theta JA}$ | 120   | $^{\circ}\text{C}/\text{W}$ |

## NOTES

(a) For a device surface mounted on 25mm x 25mm FR4 PCB with high coverage of single sided 1oz copper, in still air conditions

(b) For a device surface mounted on FR4 PCB measured at  $t \leq 5$  secs.

(c) Repetitive rating - pulse width limited by maximum junction temperature. Refer to Transient Thermal Impedance graph.

(d) For device with one active die.

(e) For device with two active die running at equal power.

# ZXT12N20DX

## CHARACTERISTICS

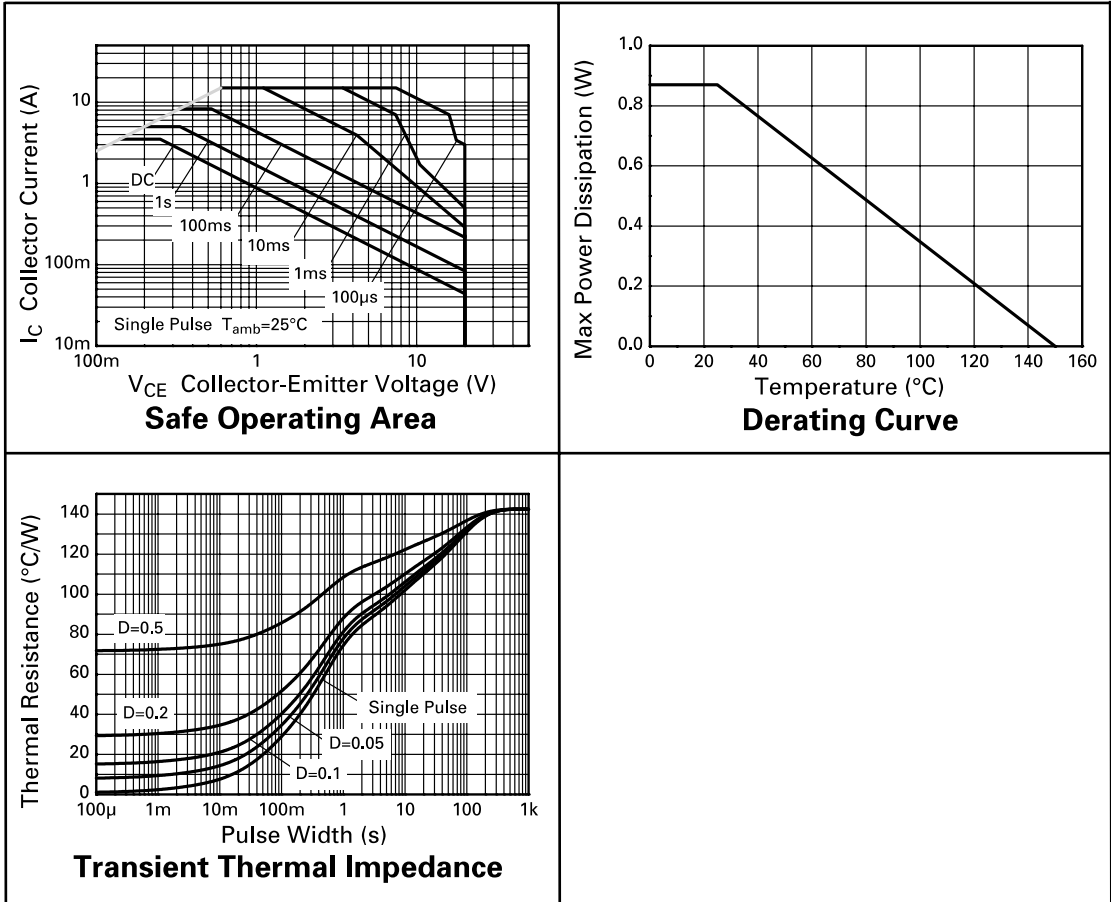

# ZXT12N20DX

## ELECTRICAL CHARACTERISTICS (at $T_{amb} = 25^{\circ}\text{C}$ unless otherwise stated).

| PARAMETER                             | SYMBOL        | MIN.                    | TYP.                    | MAX.                    | UNIT                 | CONDITIONS.   |
|---------------------------------------|---------------|-------------------------|-------------------------|-------------------------|----------------------|---|
| Collector-Base Breakdown Voltage      | $V_{(BR)CBO}$ | 50                      | 100                     |                         | V                    | $I_C=100\mu\text{A}$  |
| Collector-Emitter Breakdown Voltage   | $V_{(BR)CEO}$ | 20                      | 30                      |                         | V                    | $I_C=10\text{mA}^*$   |
| Emitter-Base Breakdown Voltage        | $V_{(BR)EBO}$ | 7.5                     | 8.5                     |                         | V                    | $I_E=100\mu\text{A}$  |
| Collector Cut-Off Current             | $I_{CBO}$     |                         |                         | 100                     | nA                   | $V_{CB}=40\text{V}$   |
| Emitter Cut-Off Current               | $I_{EBO}$     |                         |                         | 100                     | nA                   | $V_{EB}=6\text{V}$  |
| Collector Emitter Cut-Off Current     | $I_{CES}$     |                         |                         | 100                     | nA                   | $V_{CES}=40\text{V}$  |
| Collector-Emitter Saturation Voltage  | $V_{CE(sat)}$ |                         | 7.0<br>65<br>120<br>160 | 10<br>100<br>160<br>200 | mV<br>mV<br>mV<br>mV | $I_C=0.1\text{A}, I_B=10\text{mA}^*$<br>$I_C=1\text{A}, I_B=10\text{mA}^*$<br>$I_C=3\text{A}, I_B=150\text{mA}^*$<br>$I_C=3.5\text{A}, I_B=50\text{mA}^*$     |
| Base-Emitter Saturation Voltage       | $V_{BE(sat)}$ |                         | 0.9                     | 1.0                     | V                    | $I_C=3.5\text{A}, I_B=50\text{mA}^*$  |
| Base-Emitter Turn-On Voltage          | $V_{BE(on)}$  |                         | 0.85                    | 0.9                     | V                    | $I_C=3.5\text{A}, V_{CE}=2\text{V}^*$   |
| Static Forward Current Transfer Ratio | $h_{FE}$      | 250<br>300<br>200<br>40 | 400<br>450<br>320<br>70 | 900                     |                      | $I_C=10\text{mA}, V_{CE}=2\text{V}^*$<br>$I_C=1\text{A}, V_{CE}=2\text{V}^*$<br>$I_C=3.5\text{A}, V_{CE}=2\text{V}^*$<br>$I_C=10\text{A}, V_{CE}=2\text{V}^*$ |
| Transition Frequency                  | $f_T$         |                         | 112                     |                         | MHz                  | $I_C=50\text{mA}, V_{CE}=10\text{V}$<br>$f=50\text{MHz}$  |
| Output Capacitance                    | $C_{obo}$     |                         | 43                      |                         | pF                   | $V_{CB}=10\text{V}, f=1\text{MHz}$  |
| Turn-On Time                          | $t_{(on)}$    |                         | 65                      |                         | ns                   | $V_{CC}=10\text{V}, I_C=2\text{A}$<br>$I_{B1}=I_{B2}=40\text{mA}$   |
| Turn-Off Time                         | $t_{(off)}$   |                         | 400                     |                         | ns                   |   |

\*Measured under pulsed conditions. Pulse width=300 $\mu\text{s}$ . Duty cycle  $\leq 2\%$

# ZXT12N20DX

## TYPICAL CHARACTERISTICS

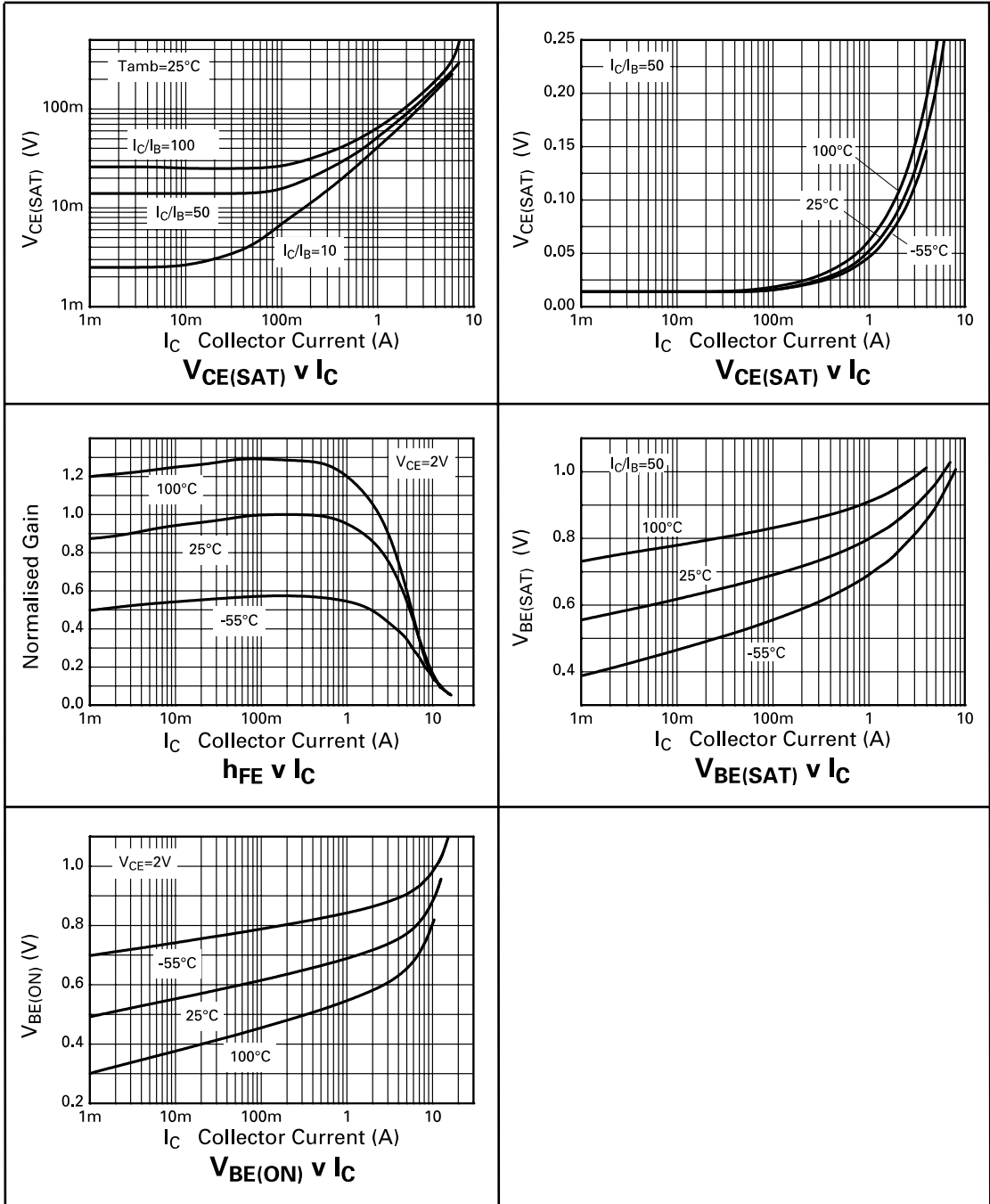

# ZXT12N20DX

## PACKAGE DIMENSIONS

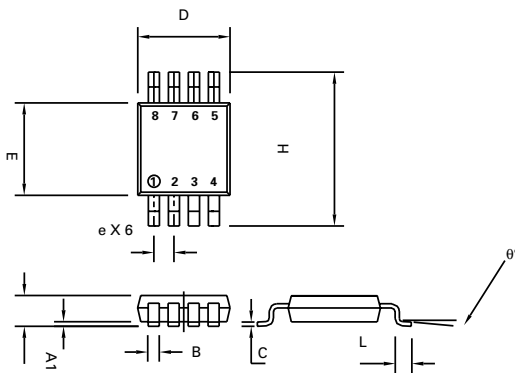

Conforms to JEDEC MO-187 Iss A

## PAD LAYOUT DETAILS

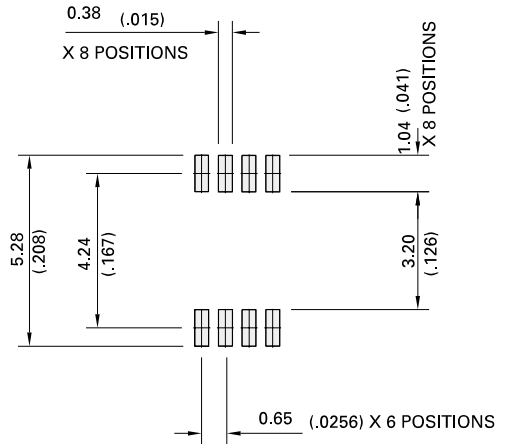

| DIM | Millimetres |      | Inches |       |
|-----|-------------|------|--------|-------|
|     | MIN         | MAX  | MIN    | MAX   |
| A   |             | 1.10 |        | 0.043 |
| A1  | 0.05        | 0.15 | 0.002  | 0.006 |
| B   | 0.25        | 0.40 | 0.010  | 0.016 |
| C   | 0.13        | 0.23 | 0.005  | 0.009 |
| D   | 2.90        | 3.10 | 0.114  | 0.122 |
| e   | 0.65        | BSC  | 0.0256 | BSC   |
| E   | 2.90        | 3.10 | 0.114  | 0.122 |
| H   | 4.90        | BSC  | 0.193  | BSC   |
| L   | 0.40        | 0.70 | 0.016  | 0.028 |
| q°  | 0°          | 6°   | 0°     | 6°    |



Zetex plc.  
Fields New Road, Chadderton, Oldham, OL9-8NP, United Kingdom.  
Telephone: (44)161 622 4422 (Sales), (44)161 622 4444 (General Enquiries)  
Fax: (44)161 622 4420

Zetex GmbH  
Streitfeldstraße 19  
D-81673 München  
Germany  
Telefon: (49) 89 45 49 49 0  
Fax: (49) 89 45 49 49 49

Zetex Inc.  
47 Mall Drive, Unit 4  
Commack NY 11725  
USA  
Telephone: (631) 543-7100  
Fax: (631) 864-7630

Zetex (Asia) Ltd.  
3510 Metroplaza, Tower 2  
Hing Fong Road,  
Kwai Fong, Hong Kong  
Telephone: (852) 26100 611  
Fax: (852) 24250 494

These are supported by  
agents and distributors in  
major countries world-wide  
© Zetex plc 2000

Internet <http://www.zetex.com>

This publication is issued to provide outline information only which (unless agreed by the Company in writing) may not be used, applied or reproduced for any purpose or form part of any order or contract or be regarded as a representation relating to the products or services concerned. The Company reserves the right to alter without notice the specification, design, price or conditions of supply of any product or service.