

Versatile Filtered Power Entry Module



- Rated currents up to 6 A
- Single or dual-fuse holder
- Fuses Ø6.3 x 32 mm Ø5 x 20 mm
- 2-pole rocker switch
- General purpose application
- Optional medical versions (B type)



Performance indicators

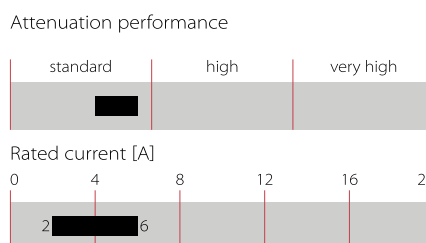

Approvals



The FN 380 power entry module combines an IEC inlet, a mains filter with a single or dual fuse holder and a 2-pole rocker switch. Choosing FN 380 product line brings you the rapid availability of a standard filter associated with the necessary safety acceptances. Standard IEC connector filters are a practical solution helping you to pass EMI system approval in a short time. A wide selection on amperage ratings, fuse options, mounting possibilities and filters for medical applications are designed to offer you the desired solution.

Features and benefits

- Good conducted attenuation performance, based on chokes with high saturation resistance and excellent thermal behavior
- Front or snap-in mounting
- Single or dual-fuse holder
- USA Ø6.3 x 32 mm or EU Ø5 x 20 mm fuses
- 2-pole rocker switch
- Custom-specific versions are available on request

Technical specifications

Maximum continuous operating voltage	250 VAC, 50/60 Hz
Operating frequency	DC to 400 Hz 50 to 400 Hz
Rated currents	2 to 6 A @ 40°C max.
High potential test voltage	P → PE 2000 VAC for 2 sec (standard types) P → PE 2500 VAC for 2 sec (B types) P → N 760 VAC for 2 sec
Protection category	IP 40 according to IEC 60529
Temperature range (operation and storage)	-25°C to +85°C (25/85/21)
Design corresponding to	UL 1283, CSA 22.2 No. 8 1986, IEC/EN 60939
Flammability corresponding to	UL 94 V-2 or better
MTBF @ 40°C/230 V (Mil-HB-217F)	550,000 hours
Function	2-pole, dark not illuminated Marking I - 0
Electrical specifications	Inrush current 51 A 10,000 on-off operations according to ENEC 6,000 on-off operations according to UL 1054, TV 5
Mechanical life	50,000 cycles
Switch ratings	
Europe (ENEC)	6 A (4 A), 250 VAC*
USA (UL)	6 A, 125 VAC; 4 A, 250 VAC; 1/10 HP
Canada (CSA)	6 A, 125 VAC; 4 A, 250 VAC; 1/10 HP
Output connections	Blade terminals acc. DIN 46 244-A4-8-0.8 (do not connect by soldering)

* Value in () relates to the inductive current charge: cos φ=0.65

Typical applications

- Portable electrical and electronic equipment
- Consumer goods
- EDP and office equipment
- Single-phase power supplies, switch-mode power supplies
- Test and measurement equipment
- Medical equipment

Typical electrical schematic

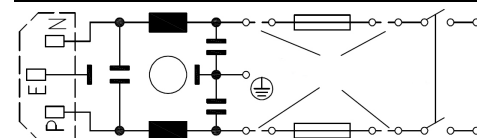

Filter selection table

Filter*	Rated current @ 40°C (25°C)	Leakage current** @ 230 VAC/50 Hz	Inductance L	Capacitance Cx	Cy	Resistance R	Output connections	Fuses***	Weight
	[A]	[µA]	[mH]	[nF]	[nF]	[kΩ]		[Qty]	[g]
FN 380-2-2.	2 (2.4)	373	0.70	47	2.2		13	1	55
FN 380-4-2.	4 (4.8)	373	0.30	47	2.2		13	1	55
FN 380-6-2.	6 (7.2)	373	0.18	47	2.2		13	1	55
FN 382-2-2.	2 (2.4)	373	0.70	47	2.2		13	2	55
FN 382-4-2.	4 (4.8)	373	0.30	47	2.2		13	2	55
FN 382-6-2.	6 (7.2)	373	0.18	47	2.2		13	2	55
FN 385-2-2.	2 (2.4)	373	2.00	47	2.2		13	2	65
FN 385-4-2.	4 (4.8)	373	0.80	47	2.2		13	2	65
FN 385-6-2.	6 (7.2)	373	0.50	47	2.2		13	2	65
FN 388-2-2.	2 (2.4)	373	0.70	47	2.2		13	2	60
FN 388-4-2.	4 (4.8)	373	0.30	47	2.2		13	2	60
FN 388-6-2.	6 (7.2)	373	0.18	47	2.2		13	2	60
FN 389-2-2.	2 (2.4)	373	2.00	47	2.2		13	2	70
FN 389-4-2.	4 (4.8)	373	0.80	47	2.2		13	2	70
FN 389-6-2.	6 (7.2)	373	0.50	47	2.2		13	2	70
FN 382 B-2-2.	2 (2.4)	2	0.70	47		1000	13	2	55
FN 382 B-4-2.	4 (4.8)	2	0.30	47		1000	13	2	55
FN 382 B-6-2.	6 (7.2)	2	0.18	47		1000	13	2	55
FN 389 B-2-2.	2 (2.4)	2	2.00	47		1000	13	2	70
FN 389 B-4-2.	4 (4.8)	2	0.80	47		1000	13	2	70
FN 389 B-6-2.	6 (7.2)	2	0.50	47		1000	13	2	70





* Select the requested fuse holder for fuse EUR-1 or USA-1.

** Maximum leakage under normal operating conditions. Note: if the neutral line is interrupted, worst case leakage could reach twice this level.

*** Filters are delivered without fuse.

Product selector

FN 38xx-y-zz

1:	Fuse Ø5 x 20mm (FUSE-H EUR-1)
2:	Fuse Ø6.3 x 32mm (FUSE-H USA-1)
2:	Rocker switch, 2-pole, dark not illuminated
2 to 6:	Rated current
Blank:	Standard version
B:	Medical version (with bleed resistor and without Y2-capacitor)
 0:	Snap-in version, single-fuse, standard performance
 2:	Snap-in version, dual-fuse, standard performance
 5:	Snap-in version, dual-fuse, high performance
 8:	Flange mounting version, dual-fuse, standard performance
 9:	Flange mounting version, dual-fuse, high performance

Typical filter attenuation

Per CISPR 17; A=50 Ω/50 Ω sym; B=50 Ω/50 Ω asym; C=0.1 Ω/100 Ω sym; D=100 Ω/0.1 Ω sym

FN 380/FN 382/FN 388

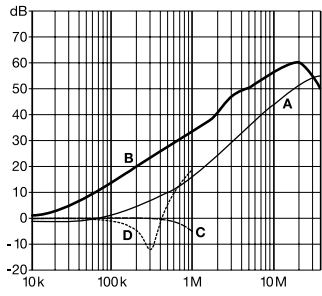

FN 385/FN 389

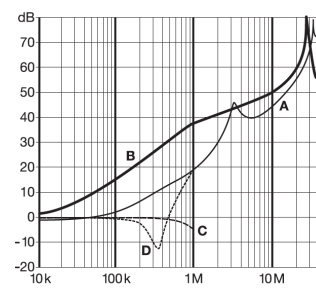

6A type only

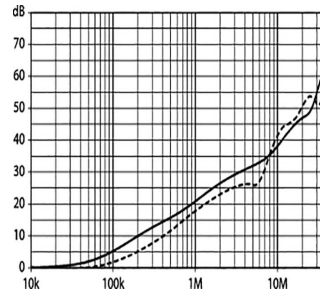

Mechanical data

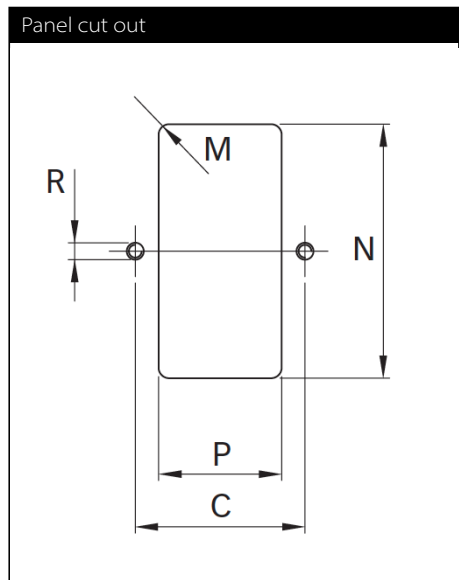
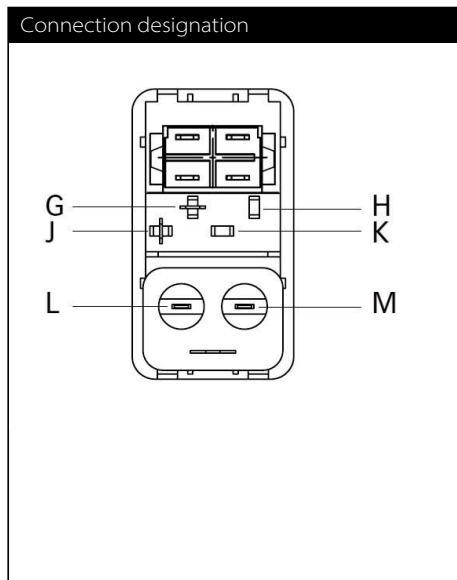
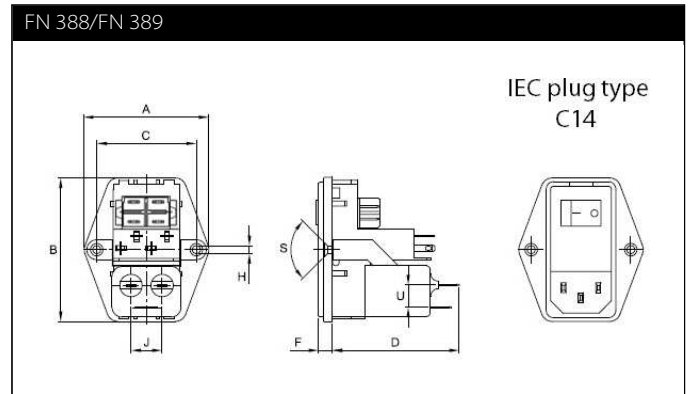
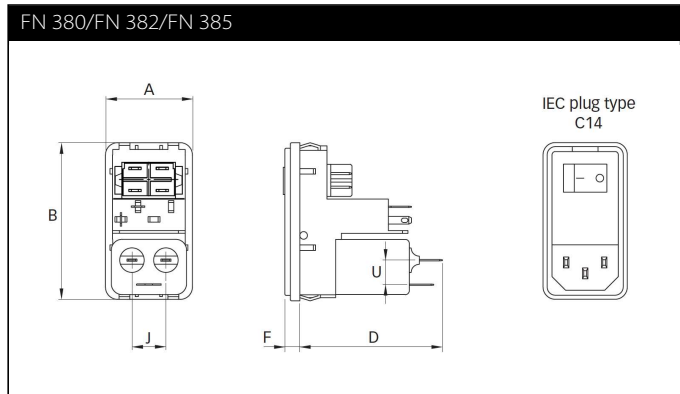

Dimensions

	FN 380	FN 382	FN 385	FN 388	FN 389	Tolerances
A	32	32	32	50	50	±0.3
B	58	58	58	58	58	±0.3
C				40	40	±0.1
D	51	51	61	51	61	
F	5.5	5.5	5.5	5.5	5.5	
H				Ø3.3	Ø3.3	
J	12.5	12.5	12.5	12.5	12.5	
M	R ≤2	R ≤2	R ≤2	R ≤2	R ≤2	±0.1
N	55.9*/56.2**	55.9*/56.2**	55.9*/56.2**	55.9*/56.2**	55.9*/56.2**	+0.2/-0
P	28.5	28.5	28.5	28.5	28.5	+0.2/-0
R				M3	M3	
S				90°	90°	
U	9	9	9	9	9	

* For a back panel thickness between 0.8 and 2.0 mm

** For a back panel thickness between 2.1 and 3.2 mm

All dimensions in mm; 1 inch=25.4 mm

Tolerances according: ISO 2768-m/EN 22768-m

Please visit www.schaffner.com to find more details on filter connectors.



Headquarters, global innovation and development

Switzerland

Schaffner Group

Nordstrasse 11
4542 Luterbach
T +41 32 681 66 26
info@schaffner.com
<http://www.schaffner.com>



Sales and application centers

China

Schaffner EMC Ltd. Shanghai

T20-3 C, No 565 Chuangye Road,
Pudong district
201201 Shanghai
T +86 21 3813 9500
cschina@schaffner.com
<http://www.schaffner.com.cn>

Finland

Schaffner Oy

Sauvonrinne 19 H
08500 Lohja
T +358 50 468 7284
finlandsales@schaffner.com

France

Schaffner EMC S.A.S.

16-20 Rue Louis Rameau
95875 Bezons
T +33 1 34 34 30 60
F +33 1 39 47 02 28
francesales@schaffner.com

Germany

Schaffner Deutschland GmbH

Schoemperlenstrasse 12B
76185 Karlsruhe
T +49 721 56910
F +49 721 569110
germanysales@schaffner.com

India

Schaffner India Pvt. Ltd

Unit 59, Level, Mfar Greenheart 7
Manyata Tech Park, Hebbal Outer Ring Road
560045 Bangalore
T +91 80 6781 9805
F +91 80 6781 9998
indiasales@schaffner.com

Italy

Schaffner EMC S.r.l.

Via Ticino, 30
20900 Monza (MB)
T +39 039 21 41 070
italysales@schaffner.com

Japan

Schaffner EMC K.K.

1-32-12, Kamiyama, Setagaya-ku
7F Mitsui-seimei Sengenjaya Bldg.
154-0011 Tokyo
T +81 3 5712 3650
F +81 3 5712 3651
japansales@schaffner.com
<http://www.schaffner.jp>

Singapore

Schaffner EMC Pte Ltd.

#05-09, Kg Ubi Ind. Estate
408705 Singapore
T +65 6377 3283
F +65 6377 3281
singaporesales@schaffner.com

Spain

Schaffner EMC España

Calle Caléndula 93, Miniparc III, Edificio E
El Soto de Moraleja, Alcobendas
28109 Madrid
T +34 917 912 900
F +34 917 912 901
spainsales@schaffner.com

Sweden

Schaffner EMC AB

Tegeluddsvägen 76, 2tr
115 28 Stockholm
T +46 8 5050 2425
swedensales@schaffner.com
<http://www.schaffner.com>

Switzerland

Schaffner EMV AG

Nordstrasse 11
4542 Luterbach
T +41 32 681 66 26
switzerlandsales@schaffner.com

Taiwan R.O.C.

Schaffner EMV Ltd.

20 Floor-2, No 97, Section 1, XinTai 5th Road
22175 XiZhi District New Taipei City 22175
T +886 2 2697 5500
F +886 2 2697 5533
taiwansales@schaffner.com
<http://www.schaffner.com.tw>

Thailand

Schaffner EMC Co. Ltd.

Northern Region Industrial Estate
67 Moo 4 Tambon Ban Klang
Amphur Muangng P.O. Box 14
51000 Lamphun
T +66 53 58 11 04
F +66 53 58 10 19
thailandsales@schaffner.com

United Kingdom

Schaffner Ltd.

5 Ashville Way, Molly Millars Lane
Wokingham
RG41 2PL Berkshire
T +44 118 9770070
F +44 118 9792969
uksales@schaffner.com

USA

Schaffner EMC Inc.

52 Mayfield Avenue
08837 Edison, New Jersey
T +1 800 367 5566
T +1 732 225 9533
F +1 732 225 4789
usasales@schaffner.com
<http://www.schaffnerusa.com>

Schaffner North America

6722 Thirlane Road
24019 Roanoke, Virginia
T +1 276 228 7943
F +1 276 228 7953

Schaffner North America

823 Fairview Road
24382 Wytheville, Virginia
T +1 276 228 7943
F +1 276 228 7258

To find your local partner within Schaffner's global network: www.schaffner.com

© 2017 Schaffner Group

The content of this document has been carefully checked and understood. However, neither Schaffner nor its subsidiaries assume any liability whatsoever for any errors or inaccuracies of this document and the consequences thereof. Published specifications are subject to change without notice. Product suitability for any area of application must ultimately be determined by the customer. In all cases, products must never be operated outside their published specifications. Schaffner does not guarantee the availability of all published products. This disclaimer shall be governed by substantive Swiss law and resulting disputes shall be settled by the courts at the place of business of Schaffner Holding AG. Latest publications and a complete disclaimer can be downloaded from the Schaffner website. All trademarks recognized.