



# UM30-215118

UM30

ULTRASONIC SENSORS

**SICK**  
Sensor Intelligence.



### Ordering information

Type	Part no.
UM30-215118	6036925

Other models and accessories → [www.sick.com/UM30](http://www.sick.com/UM30)



### Detailed technical data

#### Performance

<b>Operating range, limiting range</b>	600 mm ... 6,000 mm, 8,000 mm
<b>Target</b>	Natural objects
<b>Resolution</b>	≥ 0.18 mm
<b>Repeatability</b>	± 0.15 % <sup>1)</sup>
<b>Accuracy</b>	± 1 % <sup>1) 2)</sup>
<b>Temperature compensation</b>	✓
<b>Response time</b>	240 ms
<b>Switching frequency</b>	3 Hz
<b>Output time</b>	60 ms
<b>Ultrasonic frequency (typical)</b>	80 kHz
<b>Detection area (typical)</b>	See diagrams
<b>Additional function</b>	Set switching mode: Distance to object (DtO) / Window (Wnd) / Object between sensor and background (ObSB), teach-in of switching output, set levels of switching outputs, Invertable switching output, set on delay switching output, teach-in of analog output, scaling of analog outputs, Invertable analog output, automatic selection of analog current or voltage output, temperature compensation, synchronization of up to 10 sensors, multiplexing: no cross talk of up to 50 sensors, set measurement filters: value filter, filter strength, adjustable sensitivity, foreground suppression and detection area, switch-off display, reset to factory default <sup>3)</sup>

<sup>1)</sup> Referring to current measurement value.

<sup>2)</sup> Temperature compensation can be switched off, without temperature compensation: 0.17 % / K.

<sup>3)</sup> Functions may vary depending on sensor type.

#### Interfaces

<b>Analog output</b>	1 x 0 V ... 10 V (≥ 100 kΩ) 1 x 4 mA ... 20 mA (≤ 500 Ω) <sup>1) 1) 2) 3)</sup>
<b>Resolution analog output</b>	12 bit

<sup>1)</sup> Automatic selection of analog current or voltage output dependent on load.

<sup>2)</sup> For 4 mA ... 20 mA and  $V_S \leq 20$  V max. load ≤ 100 Ω.

<sup>3)</sup> Subsequent smoothing of the analog output, depending on the application, may increase the response time by up to 200 %.

<sup>4)</sup> PNP: HIGH =  $V_S - (< 2$  V) / LOW = 0 V.

<b>Switching output</b>	1 x PNP (200 mA) <sup>4)</sup>
<b>Multifunctional input (MF)</b>	1 x MF
<b>Hysteresis</b>	100 mm

<sup>1)</sup> Automatic selection of analog current or voltage output dependent on load.

<sup>2)</sup> For 4 mA ... 20 mA and  $V_S \leq 20$  V max. load  $\leq 100 \Omega$ .

<sup>3)</sup> Subsequent smoothing of the analog output, depending on the application, may increase the response time by up to 200 %.

<sup>4)</sup> PNP: HIGH =  $V_S - (< 2$  V) / LOW = 0 V.

## Mechanics/electronics

<b>Supply voltage <math>V_S</math></b>	DC 9 V ... 30 V <sup>1) 2)</sup>
<b>Power consumption</b>	$\leq 2.4$ W <sup>3)</sup>
<b>Initialization time</b>	< 300 ms
<b>Design</b>	Cylindrical
<b>Housing material</b>	Nickel-plated brass, PBT Display: TPU Ultrasonic transducer: polyurethane foam, glass epoxy resin
<b>Connection type</b>	Male connector, M12, 5-pin
<b>Indication</b>	LED display, 2 x LED
<b>Weight</b>	270 g
<b>Sending axis</b>	Straight
<b>Enclosure rating</b>	IP67
<b>Protection class</b>	III

<sup>1)</sup> Limit values, reverse-polarity protected Operation in short-circuit protected network: max. 8 A, class 2.

<sup>2)</sup> 15 V ... 30 V when using the analog voltage output.

<sup>3)</sup> Without load.

## Ambient data

<b>Ambient temperature operation</b>	-25 °C ... +70 °C
<b>Ambient storage temperature</b>	-40 °C ... +85 °C

## Classifications

<b>ECl@ss 5.0</b>	27270804
<b>ECl@ss 5.1.4</b>	27270804
<b>ECl@ss 6.0</b>	27270804
<b>ECl@ss 6.2</b>	27270804
<b>ECl@ss 7.0</b>	27270804
<b>ECl@ss 8.0</b>	27270804
<b>ECl@ss 8.1</b>	27270804
<b>ECl@ss 9.0</b>	27270804
<b>ETIM 5.0</b>	EC001846
<b>ETIM 6.0</b>	EC001846
<b>UNSPSC 16.0901</b>	41111960

### Dimensional drawing (Dimensions in mm (inch))

UM30-215

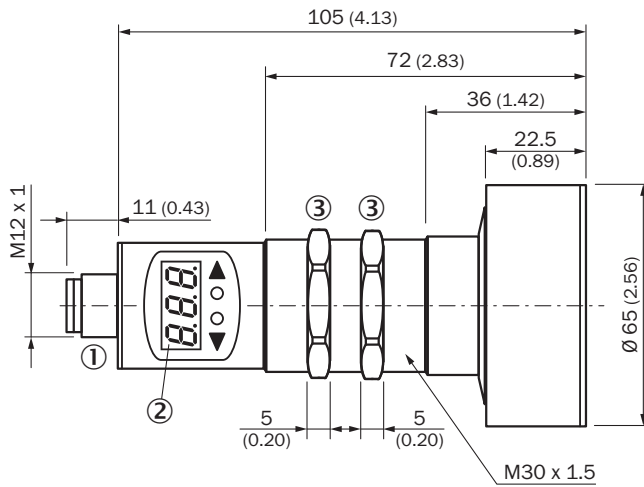

- ① Connection
- ② Display
- ③ Mounting nuts, SW 36 mm

### Connection type

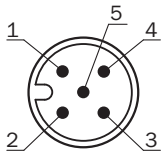

### Connection diagram

UM30-21x118 Connector M12, 5-pin

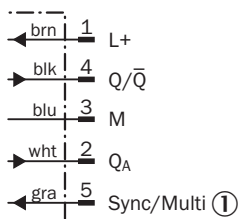

- ① Synchronization and multiplex operation/communication Connect+

Adjustment possible

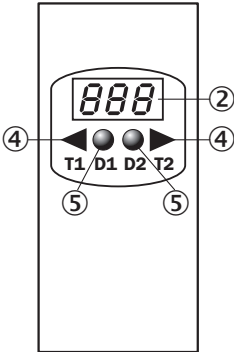

- ② Display
- ④ Operating elements
- ⑤ Status indicators

Detection area



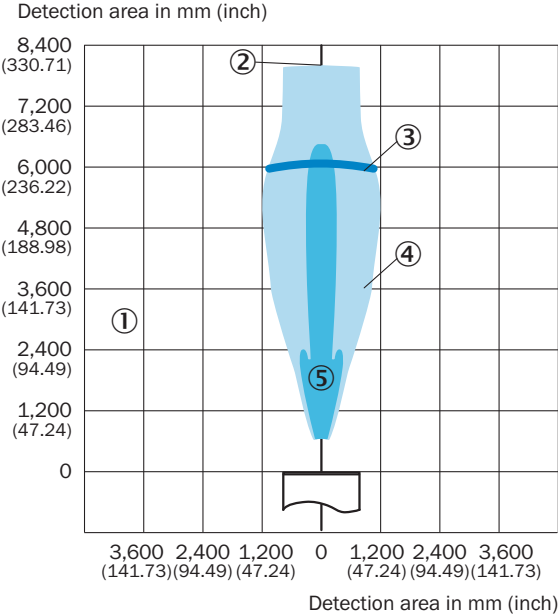

UM30-215, UC30-215

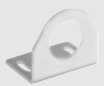

- ① Detection range dependent on reflection properties, size, and alignment of the object
- ② Limiting range
- ③ Operating range
- ④ Example object: aligned plate 500 mm x 500 mm
- ⑤ Example object: pipe with 27 mm diameter

### Recommended accessories

Other models and accessories → [www.sick.com/UM30](http://www.sick.com/UM30)

	Brief description	Type	Part no.
<b>Mounting brackets and plates</b>			
	Mounting plate for M30 sensors, steel, zinc coated, without mounting hardware	BEF-WG-M30	5321871
	Mounting bracket for M30 sensors, steel, zinc coated, without mounting hardware	BEF-WN-M30	5308445
<b>Terminal and alignment brackets</b>			
	Mounting bracket, M30, axial rotation possible, with threaded mounting hole M6, without mounting hardware	BEF-HA-M30A	5311527
<b>Plug connectors and cables</b>			
	Head A: female connector, M12, 5-pin, straight, A-coded Head B: Flying leads Cable: Sensor/actuator cable, PVC, unshielded, 2 m	YF2A15-020VB5XLEAX	2096239
	Head A: female connector, M12, 5-pin, angled, A-coded Head B: Flying leads Cable: Sensor/actuator cable, PVC, unshielded, 2 m	YG2A15-020VB5XLEAX	2096215
<b>Programming and configuration tools</b>			
	Tool for visualization, configuration and cloning, 3-digit LED display, supply voltage: DV 9 V ... 30 V	Connect+ adapter (CPA)	6037782

## SICK AT A GLANCE

SICK is one of the leading manufacturers of intelligent sensors and sensor solutions for industrial applications. A unique range of products and services creates the perfect basis for controlling processes securely and efficiently, protecting individuals from accidents and preventing damage to the environment.

We have extensive experience in a wide range of industries and understand their processes and requirements. With intelligent sensors, we can deliver exactly what our customers need. In application centers in Europe, Asia and North America, system solutions are tested and optimized in accordance with customer specifications. All this makes us a reliable supplier and development partner.

Comprehensive services complete our offering: SICK LifeTime Services provide support throughout the machine life cycle and ensure safety and productivity.

For us, that is “Sensor Intelligence.”

## WORLDWIDE PRESENCE:

Contacts and other locations –[www.sick.com](http://www.sick.com)