

THIS DRAWING IS UNPUBLISHED. RELEASED FOR PUBLICATION
 © COPYRIGHT BY TYCO ELECTRONICS CORPORATION. ALL RIGHTS RESERVED.

LOC		DIST		REVISIONS			
P	LTR	DESCRIPTION	DATE	DWN	APVD		
E		REVISED	11JUN2008	L.J	Z.J		

(2 POS.)

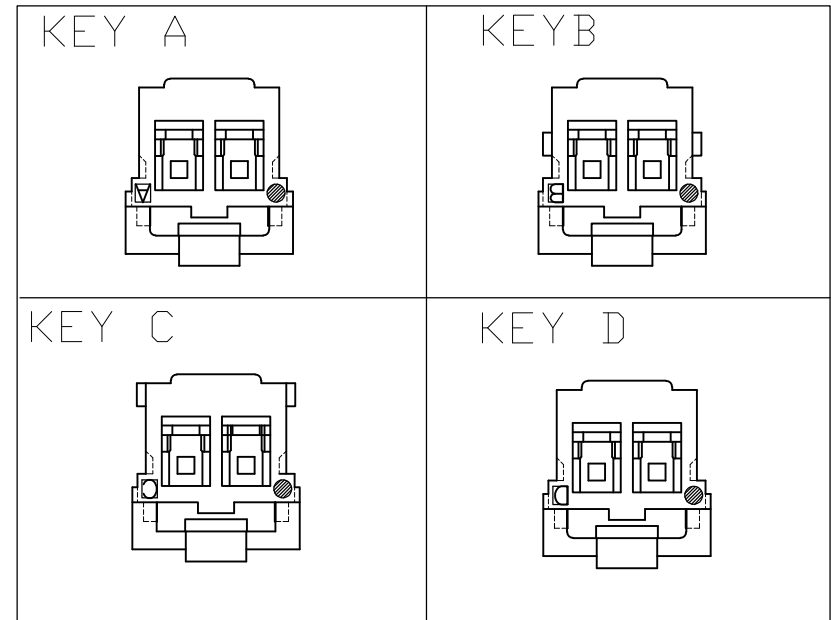
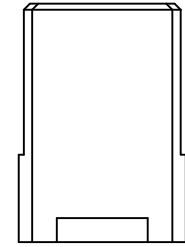

NOTE:
 1. GENERAL TOLERANCE: $\pm 0.3, \pm 3^\circ$
 2. MATERIAL: 66NYLON GF(UL94V-0)
 3. MATING CONN. P/N: SEE TABLE
 4. APPLICABLE CONTACT P/N:
 1971031-1

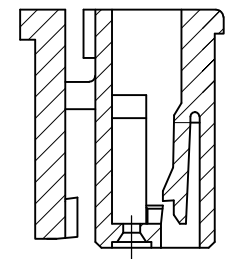
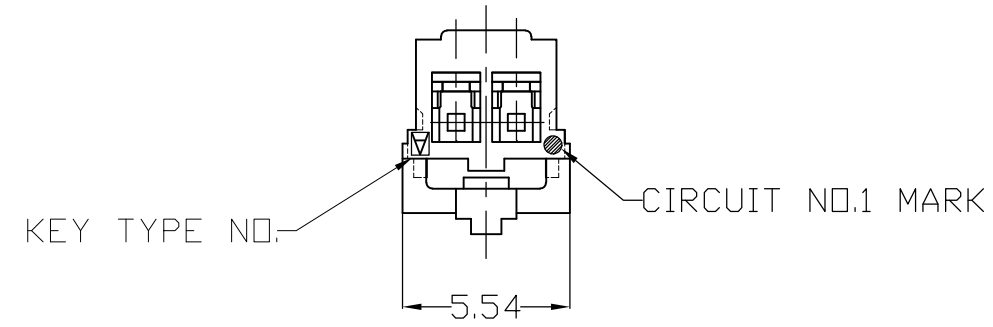

SEC. B-B

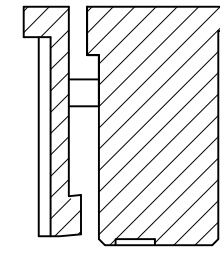

SEC. D-D

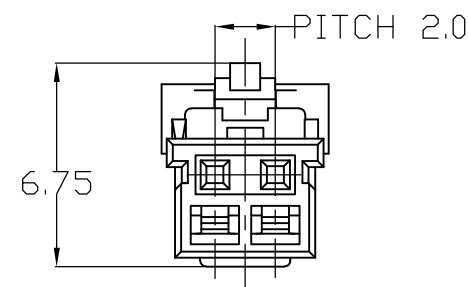
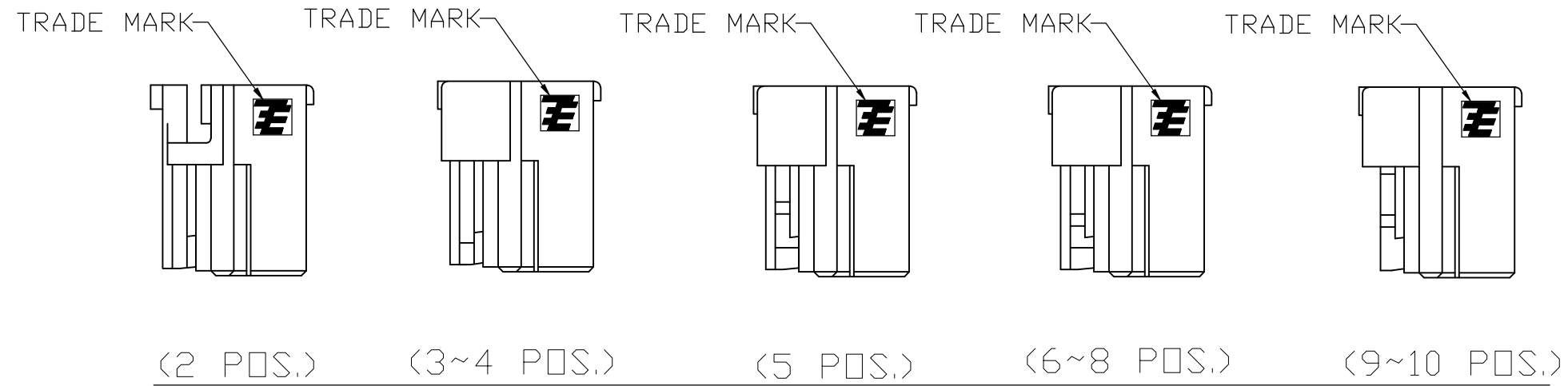
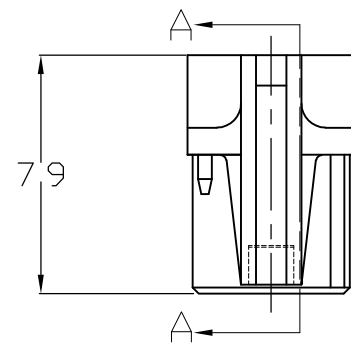
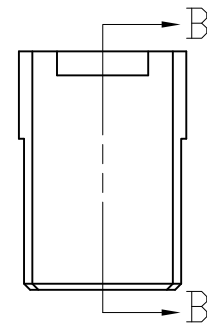

THIS DRAWING IS A CONTROLLED DOCUMENT.		DWN Liu Jimmy 11JUN2008	Tyco Electronics Corporation Shanghai, China		
DIMENSIONS: mm		CHK Wu hapye 11JUN2008			
		APVD Zhou Julian 11JUN2008	NAME Grace Inertia Connector 2.0 EV Series Plug Housing		
TOLERANCES UNLESS OTHERWISE SPECIFIED: 0 PLC ± - 1 PLC ± - 2 PLC ± - 3 PLC ± - 4 PLC ± - ANGLES ± -		PRODUCT SPEC 108-106001	SIZE A2	CAGE CODE 00779	DRAWING NO. C=1971030
MATERIAL SEE NOTE		FINISH -	WEIGHT -	RESTRICTED TO -	
CUSTOMER DRAWING			SCALE 4:1	SHEET 1 of 3	REV E

THIS DRAWING IS UNPUBLISHED. RELEASED FOR PUBLICATION
 © COPYRIGHT BY TYCO ELECTRONICS CORPORATION. ALL RIGHTS RESERVED.

LOC	DIST	REVISIONS					
ES	-	P	LTR	DESCRIPTION	DATE	DWN	APVD
		-	-	SEE SHEET1	-	-	-

(3 POS.)

(4 POS.)

(5 POS.)

(6 POS.)

(7 POS.)

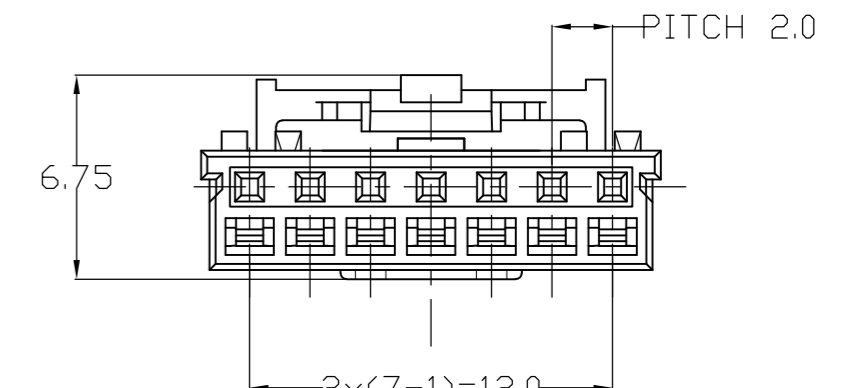
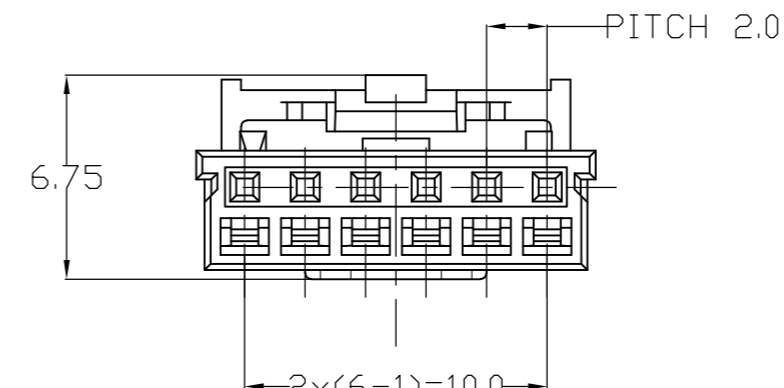
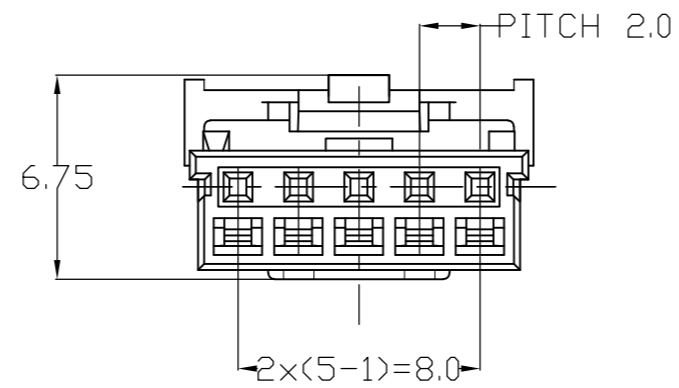
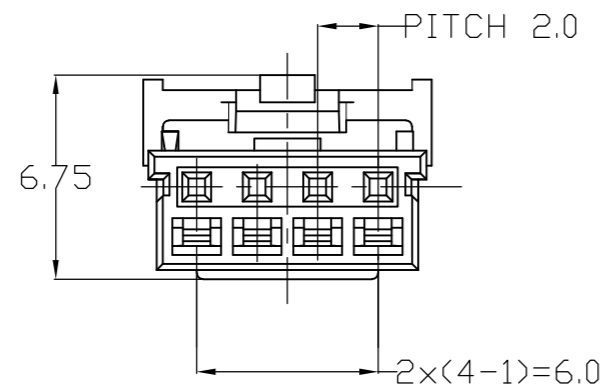
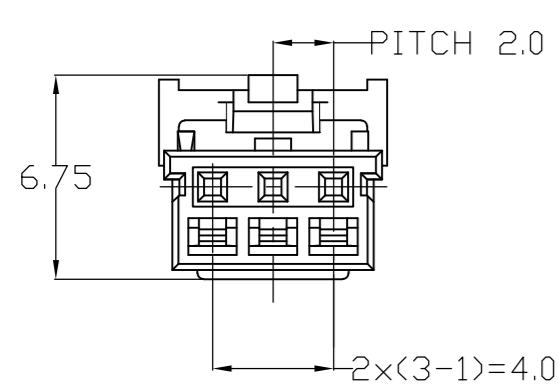
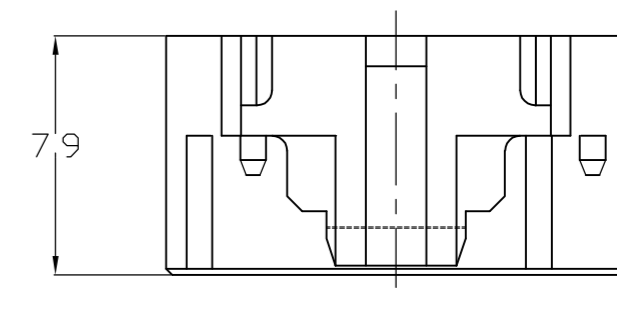
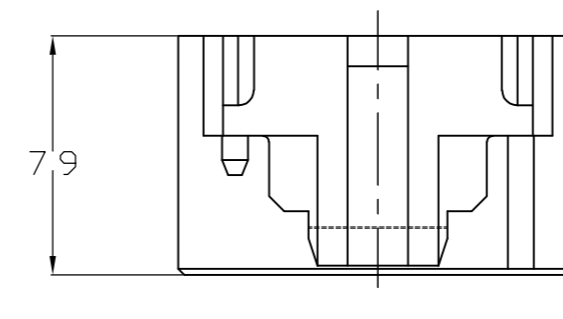
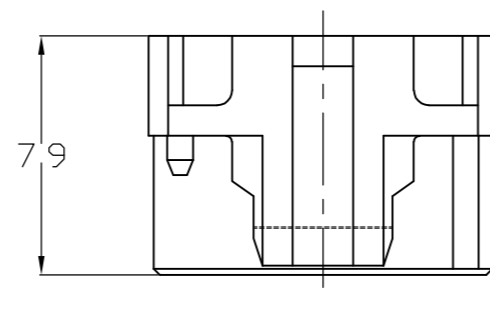
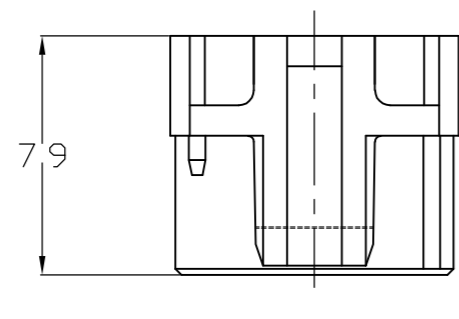
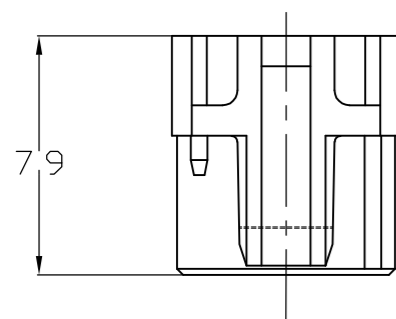
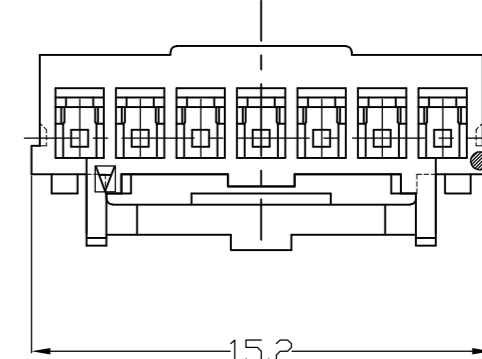
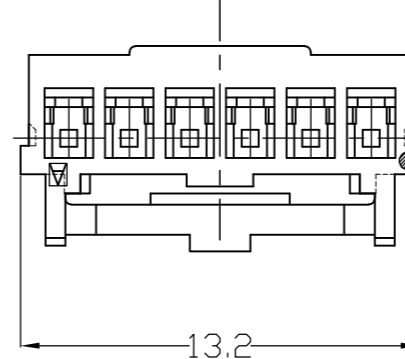
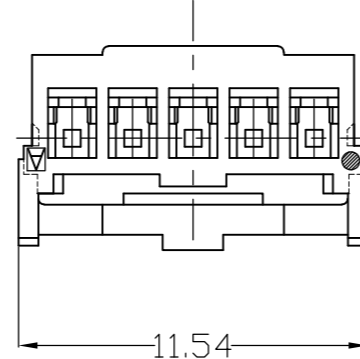
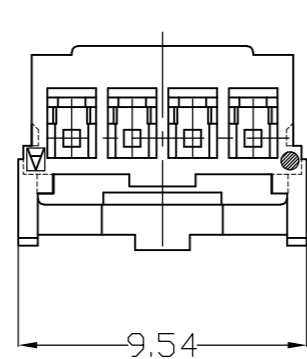
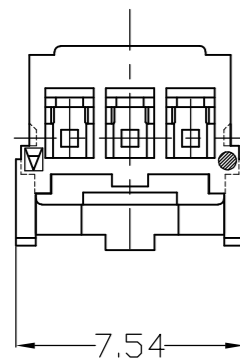
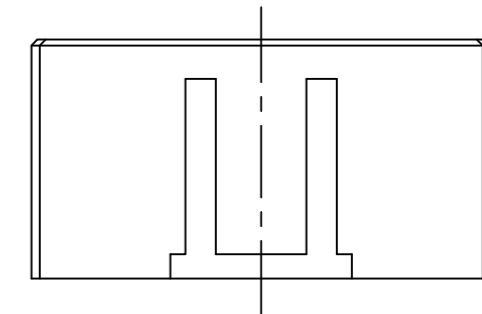
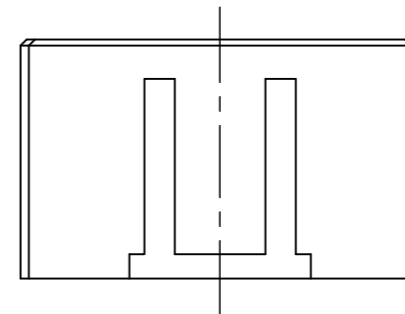
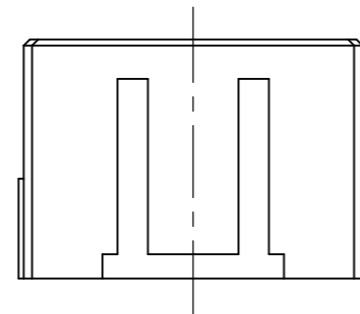
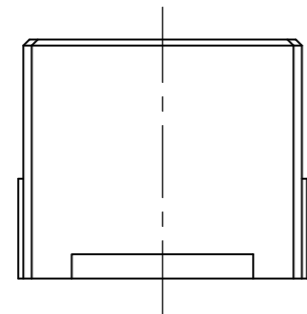
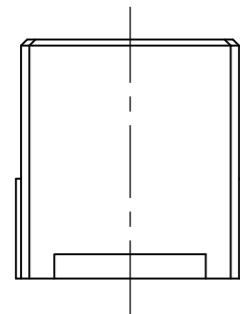

THIS DRAWING IS A CONTROLLED DOCUMENT.		DWN	Liu Jimmy	11JUN2008	Tyco Electronics Corporation Shanghai, China	
DIMENSIONS: mm		CHK	Wu Hapye	11JUN2008		
TOLERANCES UNLESS OTHERWISE SPECIFIED		APVD	Zhou Julian	11JUN2008		
0 PLC ± 1 PLC ± 2 PLC ± 3 PLC ± 4 PLC ± ANGLES ± FINISH ±		NAME	Grace Inertia Connector 2.0 EV Series Plug Housing			
MATERIAL		PRODUCT SPEC	108-106001		SIZE	A2
		APPLICATION SPEC	114-5425		CAGE CODE	00779
		WEIGHT	-		DRAWING NO	C=1971030
		CUSTOMER DRAWING			RESTRICTED TO	-
		SCALE	4:1		SHEET	2 OF 3
		REV	E			

THIS DRAWING IS UNPUBLISHED. RELEASED FOR PUBLICATION
 © COPYRIGHT BY TYCO ELECTRONICS CORPORATION. ALL RIGHTS RESERVED.

LOC	DIST	REVISIONS					
ES	-	P	LTR	DESCRIPTION	DATE	DWN	APVD
		-		SEE SHEET 1	-	-	-

(8 POS.)

(9 POS.)

(10 POS.)

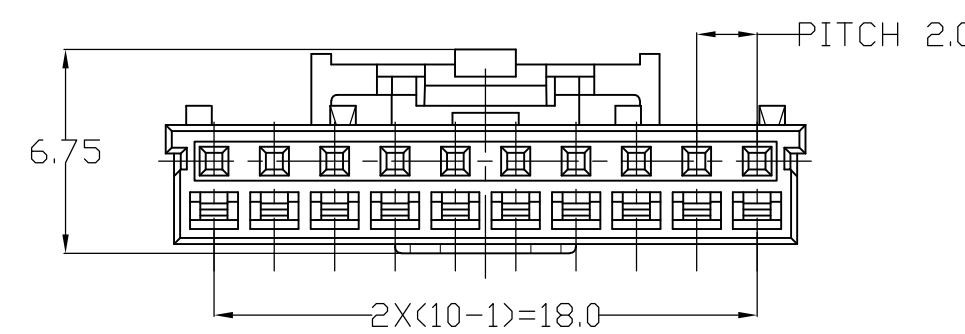
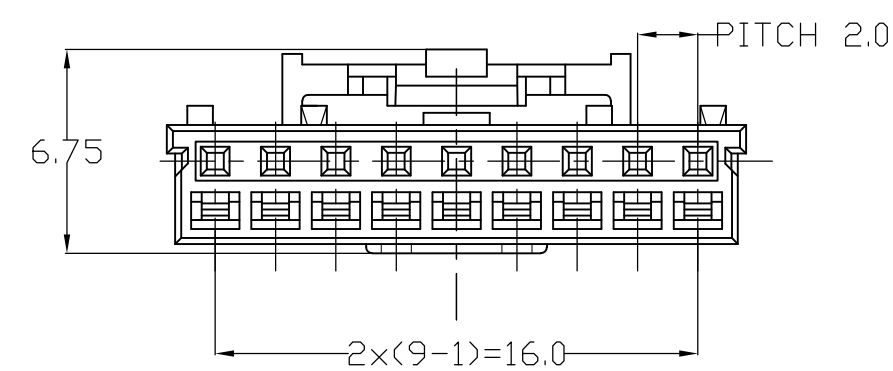
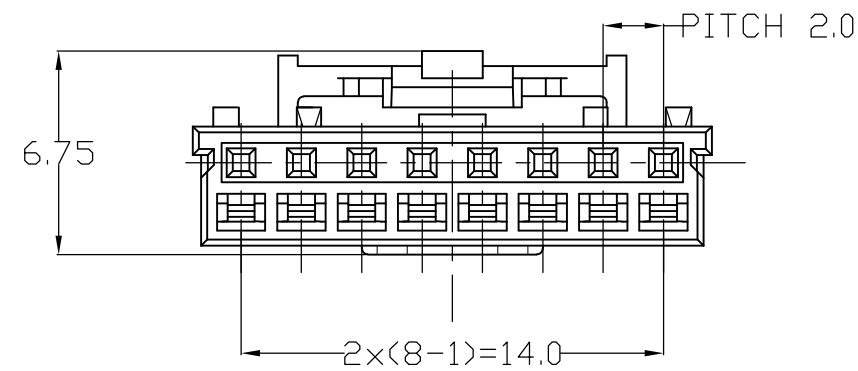
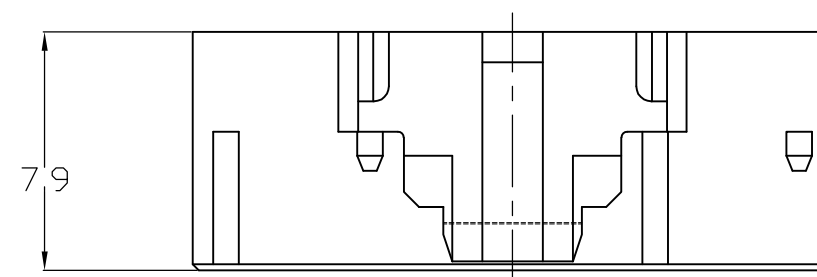
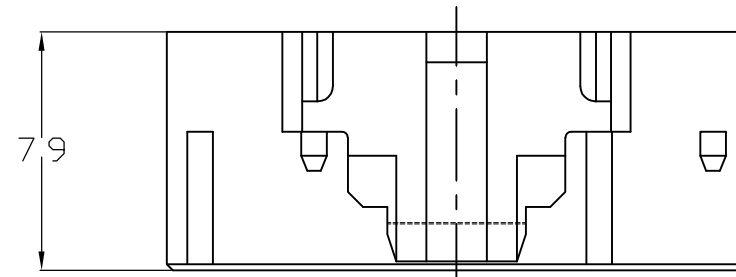
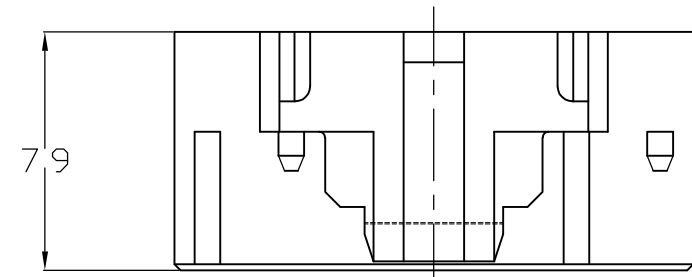
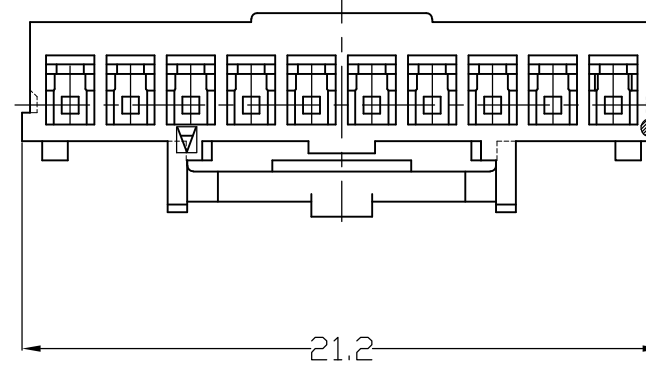
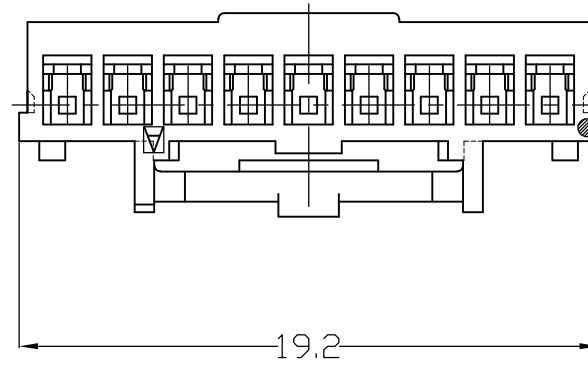
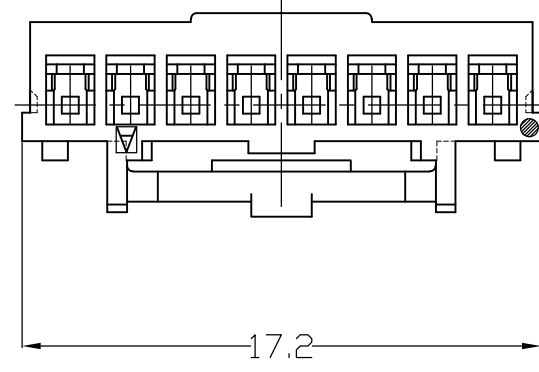
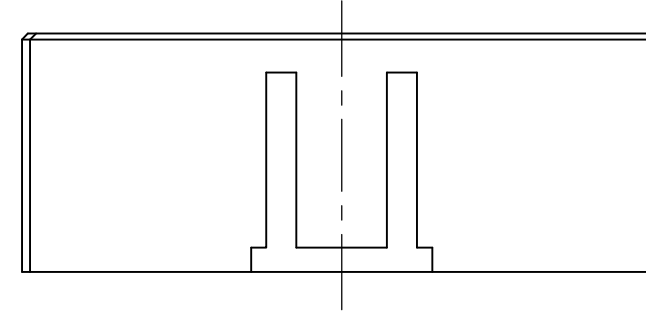
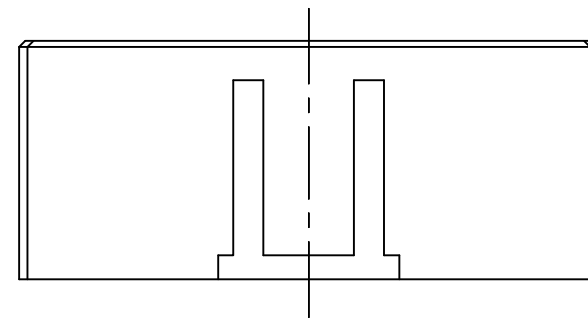
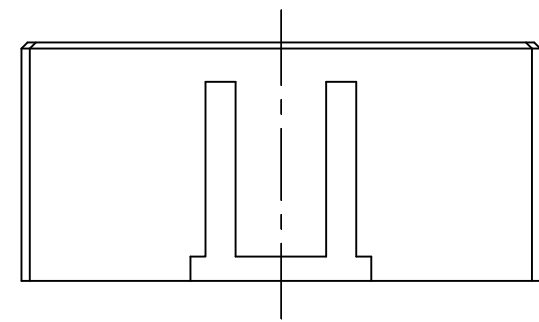

3-1971032-1	D	YELLOW	10	3-1971030-1
2-1971032-1	C	BLUE		2-1971030-1
1-1971032-1	B	RED		1-1971030-1
1971032-1	A	NATURAL		1971030-1
3-1971032-9	D	YELLOW	9	3-1971030-9
2-1971032-9	C	BLUE		2-1971030-9
1-1971032-9	B	RED		1-1971030-9
1971032-9	A	NATURAL		1971030-9
3-1971032-8	D	YELLOW	8	3-1971030-8
2-1971032-8	C	BLUE		2-1971030-8
1-1971032-8	B	RED		1-1971030-8
1971032-8	A	NATURAL		1971030-8
3-1971032-7	D	YELLOW	7	3-1971030-7
2-1971032-7	C	BLUE		2-1971030-7
1-1971032-7	B	RED		1-1971030-7
1971032-7	A	NATURAL		1971030-7
3-1971032-6	D	YELLOW	6	3-1971030-6
2-1971032-6	C	BLUE		2-1971030-6
1-1971032-6	B	RED		1-1971030-6
1971032-6	A	NATURAL		1971030-6
3-1971032-5	D	YELLOW	5	3-1971030-5
2-1971032-5	C	BLUE		2-1971030-5
1-1971032-5	B	RED		1-1971030-5
1971032-5	A	NATURAL		1971030-5
3-1971032-4	D	YELLOW	4	3-1971030-4
2-1971032-4	C	BLUE		2-1971030-4
1-1971032-4	B	RED		1-1971030-4
1971032-4	A	NATURAL		1971030-4
3-1971032-3	D	YELLOW	3	3-1971030-3
2-1971032-3	C	BLUE		2-1971030-3
1-1971032-3	B	RED		1-1971030-3
1971032-3	A	NATURAL		1971030-3
3-1971032-2	D	YELLOW	2	3-1971030-2
2-1971032-2	C	BLUE		2-1971030-2
1-1971032-2	B	RED		1-1971030-2
1971032-2	A	NATURAL		1971030-2

MATING CONNECTOR PART NUMBER	KEY TYPE	COLOR	POS.	PART NUMBER
------------------------------	----------	-------	------	-------------

THIS DRAWING IS A CONTROLLED DOCUMENT.

DWN	Liu Jimmy	11JUN2008
CHK	Wu Sam	11JUN2008
APVD	Zhou Julian	11JUN2008

NAME: Tyco Electronics Corporation, Shanghai, China

PRODUCT SPEC: 108-106001

APPLICATION SPEC: 114-5425

WEIGHT: -

SIZE: A2, CAGE CODE: 00779, DRAWING NO: 1971030, RESTRICTED TO: -

CUSTOMER DRAWING, SCALE: 4:1, SHEET: 3 of 3, REV: E