

# Solid State Relays

4-Pin SIP Package—VDC Input—VAC/VDC Output  
OSSRD2001D and OSSRD2002A



## Features:

- Molded Epoxy package
- Zero crossing circuit
- High Input/output Optical Isolation 4k Vrms
- Small size and light weight
- Can be installed directly on the P.C. board
- Fast switching time
- Non-contact switch

## Approval Agency:

- UL Certification No: E321810

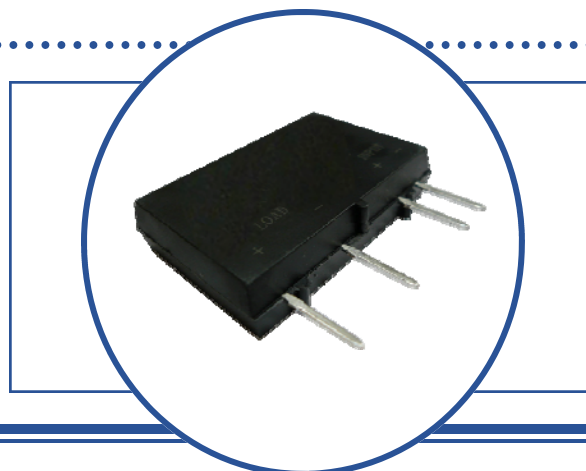

## Description:

The OSSR Solid State Relay series are electronic controlled switches, they contain no moving parts. When voltage is applied to the input, a Light Emitting Diode or LED illuminates a Photosensor which controls the internal output circuit. The output circuit is utilized to drive high current loads. The input and output are optically isolated. The OSSR series incorporates a zero crossing circuit which minimizes current and noise surges due to resistive and inductive loads. Optek provides three different electrical configurations of the OSSR series: DC input – AC output, AC input – AC output and DC input – DC output. These configurations meet most industry applications.

The **OSSRD2001D** and **OSSRD2002A** are offered in a standard 4-pin SIP, Single In-Line Package, for PCB mounting applications. The package offers a light weight, compact and robust molded epoxy body with extended operating temperature range of up to 100°C.

The **OSSRD2001D** input circuit features a DC range from 4 to 24 VDC. The output consists of a photo darlington circuit featuring a load current rating of 3 Amps and a maximum load voltage of 100VDC and 30 Watts with normally open output.

The **OSSRD2002A** input circuit features a DC range from 4 to 32 VDC. The output consists of a Triac circuit featuring a load current rating of 3 to 40 Amps and a maximum load voltage of 250VAC with normally open output.

## Applications:

- Temperature controlled systems
- Office equipment
- Motor controls
- Industrial Equipment
- Light controls systems
- Heater control
- Appliances
- HVAC temperature control
- Plastic molding
- Packaging industry



OPTEK reserves the right to make changes at any time in order to improve design and to supply the best product possible.

# Solid State Relays

4-Pin SIP Package—VDC Input—VAC/VDC Output  
 OSSRD2001D and OSSRD2002A



## Package Outline Dimensions: 4-Pin SIP

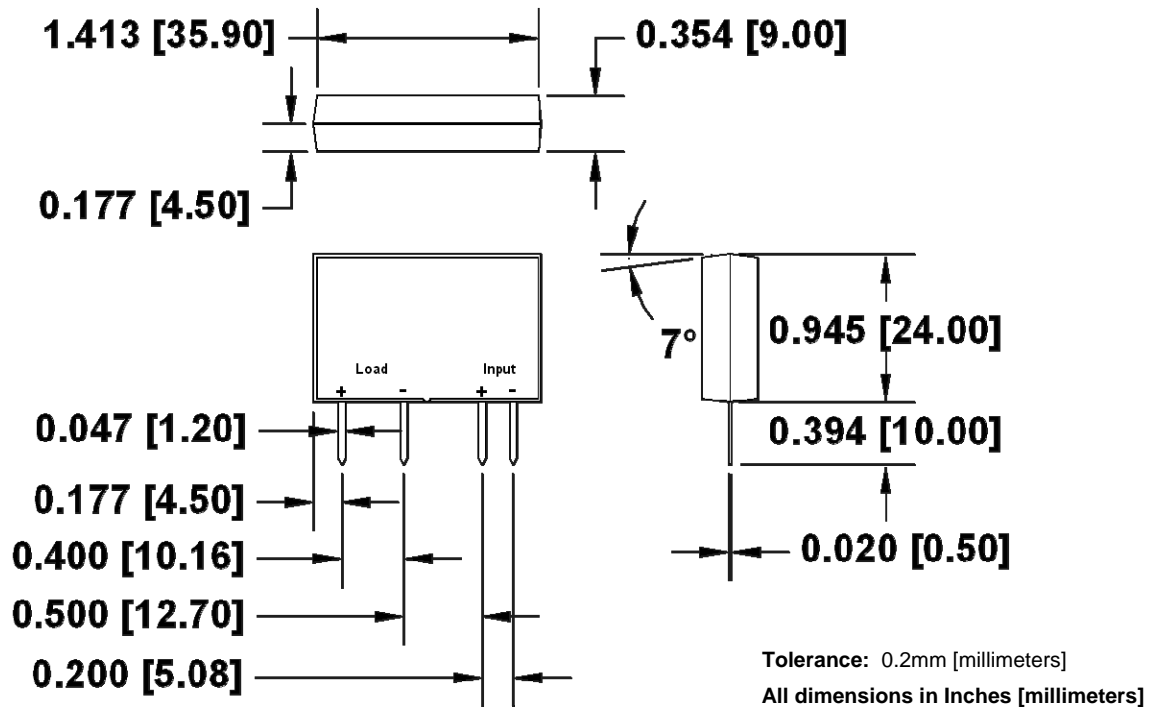

## Schematic: Top View

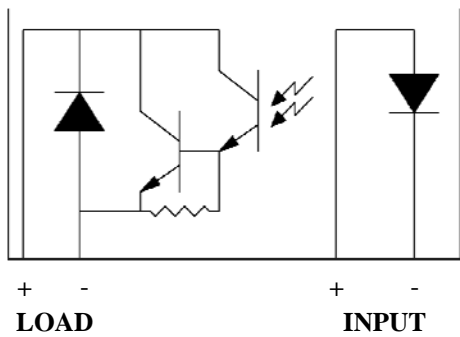

OSSRD2001D

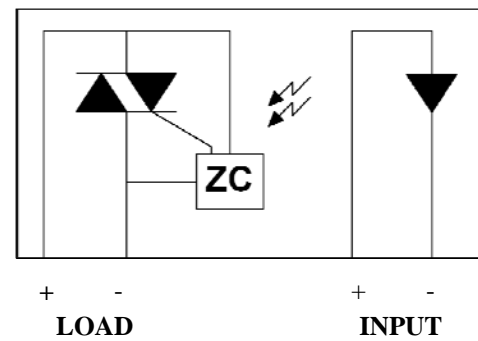

OSSRD2002A

## Pin Configuration:

Part Number	Pin #			
	1	2	3	4
OSSRD2001D	A	K	C	E (Dar.)
OSSRD2002A	A	K	A1 (+)	A2 (-)

OPTEK reserves the right to make changes at any time in order to improve design and to supply the best product possible.

# Solid State Relays

4-Pin SIP Package—VDC Input—VAC/VDC Output  
**OSSRD2001D and OSSRD2002A**



## VDC Input with VDC/VAC Output Devices Ordering Information

Part Number	Input	Min. Tgr Current Ift	Max. Output Current	Min. Ouput Current	Max. Vout	Min. Vout	Output Type	Br. Vol. Input to Output	Configuration
OSSRD2001D	4-24VDC	100mA	3A	0.05A	100VDC	-	DC	4000VAC	A K—C E (Darl.)
OSSRD2002A	4-32VDC	50mA	3A	0.05A	250VAC	50VAC	AC	4000VAC	A K—A1(+) A2(-)
Configuration: Definition of Terms LED Identification—Sensor Identification									
Configuration Information	LED	A = Anode			K = Cathode				
	Sensor	C = Collector			E = Emitter				
		A1(+) and A2(-) = Main Terminals of Triac							

### Part Number Symbolization

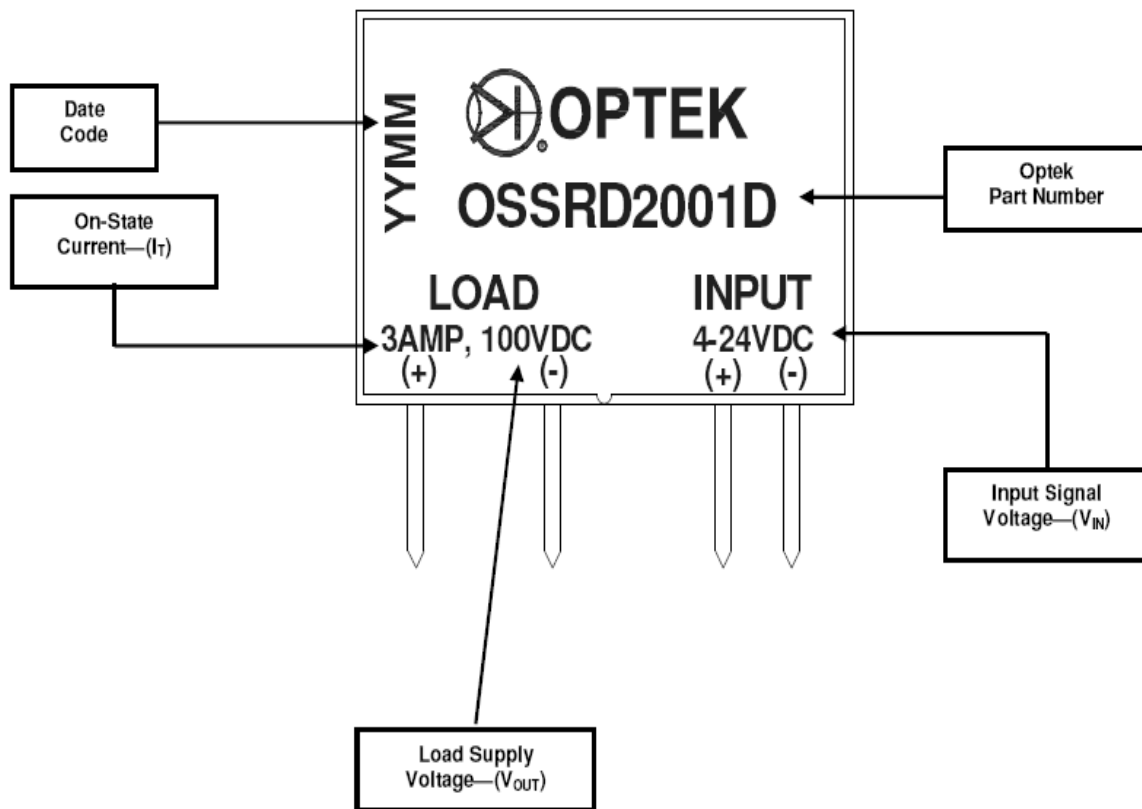

OPTEK reserves the right to make changes at any time in order to improve design and to supply the best product possible.

# Solid State Relays

## 4-Pin SIP Package—VDC Input—VAC/VDC Output

### OSSRD2001D and OSSRD2002A



#### Absolute Maximum Ratings ( $T_A = 25^\circ\text{C}$ unless otherwise noted)

<b>Storage Temperature</b> OSSRD2001D, OSSRD2002A	-30° C to +125° C
<b>Operating Temperature</b> OSSRD2001D, OSSRD2002A	-30° C to +100° C
<b>Isolation Voltage (Input to Output)</b> OSSRD2001D, OSSRD2002A	4,000 Vrms
<b>Soldering Temperature 10 sec.</b> OSSRD2001D, OSSRD2002A	260° C

#### Input Diode

<b>Input Signal Voltage—(<math>V_{IN}</math>)</b> OSSRD2001D OSSRD2002A	4—24 VDC 4—32 VDC
<b>Drop-out Voltage—(<math>V_{do}</math>)</b> OSSRD2001D, OSSRD2002A	1 VDC
<b>Output Power Dissipation—(<math>P_c</math>)</b> OSSRD2001D	30 W

#### Output Triac

<b>RMS On-State Current - (<math>I_T</math>)</b> OSSRD2002A	3 Arms
<b>Peak One Cycle Surge Current - (<math>I</math> surge)</b> OSSRD2001D @ 50 $\mu$ S OSSRD2002A @ 8.3ms	9 A 30 A
<b>Repetitive Peak-Off State Voltage—(<math>V_{DRM}</math>)</b> OSSRD2002A	600 V
<b>Operating Frequency—(<math>f</math>)</b> OSSRD2002A	47—70 Hz
<b>Critical Rate of Rise of On-State Current—(<math>di/dt</math>)</b> OSSRD2002A	50 A/ $\mu$ S
<b>Load Supply Voltage—(<math>V_{OUT}</math>)</b> OSSRD2002A	250 Vrms AC

#### Output Photo Darlington

<b>Collector Voltage - (<math>V_{CEO}</math>)</b> OSSRD2001D	100 VDC
<b>Output Current - (<math>I_o</math>)</b> OSSRD2001D	3 A

OPTEK reserves the right to make changes at any time in order to improve design and to supply the best product possible.

# Solid State Relays

## 4-Pin SIP Package—VDC Input—VAC/VDC Output

### OSSRD2001D and OSSRD2002A



#### Electrical Characteristics (T<sub>A</sub> = 25° C unless otherwise noted)

SYMBOL	PARAMETER	MIN	TYP	MAX	UNITS	TEST CONDITIONS
<b>Input Diode</b>						
V <sub>PU</sub>	<b>Pick-up Voltage</b> OSSRD2001D, OSSRD2002A	-	-	4	VDC	I <sub>T</sub> = 1Arms
I <sub>IN</sub>	<b>Input Current</b> OSSRD2001D OSSRD2002A	- 5	- -	25 12	mA	V <sub>IN</sub> = 4 - 24 V V <sub>IN</sub> = 4 - 32 V
C <sub>T</sub>	<b>Terminal Capacitance</b> OSSRD2001D	-	30	-	pF	V=0, f=1kHz

#### Output Triac

V <sub>T</sub>	<b>On-State Voltage</b> OSSRD2002A	-	-	1.5	Vrms	I <sub>T</sub> = 1Arms
I <sub>OP</sub>	<b>Operating Current</b> OSSRD2002A	50	-	-	mArms	V <sub>out</sub> = 240Vrms
I <sub>LEAK</sub>	<b>Leakage Current</b> OSSRD2002A	-	-	7	mArms	V <sub>out</sub> = 240Vrms
dv/dt	<b>Critical Rate of Rise of Off-State Voltage</b> OSSRD2002A	50	200	-	V/μs	See Note 1.
-	<b>Zero-Cross Voltage</b> OSSRD2002A	-	Yes	-	-	-
V <sub>OUT</sub>	<b>Load Voltage Rating</b> OSSRD2002A	50	-	280	VAC	I <sub>T</sub> = 50mArms MIN
I <sub>FT</sub>	<b>Minimum Trigger Current</b> OSSRD2002A	-	-	10 25	mA	V <sub>DRM</sub> = 600 V
R <sub>iso</sub>	<b>Isolation resistance Input to Output</b> OSSRD2002A	10 <sup>10</sup>	-	-	Ω	DC500 V
T <sub>ON</sub>	<b>Turn-on Time</b> OSSRD2002A	-	-	8.3	mS	60Hz AC
T <sub>OFF</sub>	<b>Turn-off Time</b> OSSRD2002A	-	-	8.3	mS	60Hz AC
R <sub>th (j-C)</sub>	<b>Thermal Resistance (between junction and case)</b>	-	1.3	-	°C/W	-

**Note1:** Output (dv/dt) protection is provided in all models, and they are designed to switch resistive or inductive loads to 0.2 factor. The dv/dt rating is based on source impedance of 50 ohms.

OPTEK reserves the right to make changes at any time in order to improve design and to supply the best product possible.

# Solid State Relays

## 4-Pin SIP Package—VDC Input—VAC/VDC Output

### OSSRD2001D and OSSRD2002A



#### Electrical Characteristics ( $T_A = 25^\circ\text{C}$ unless otherwise noted)

SYMBOL	PARAMETER	MIN	TYP	MAX	UNITS	TEST CONDITIONS
<b>Output Photodiode</b>						
$BV_{CEO}$	<b>Collector-Emitter Breakdown Voltage</b> OSSRD0001D	100	-	-	Vrms	$I_F = 0\text{mA}$
$I_{LEAK}$	<b>Output Leak Current</b> OSSRD0001D	-	-	1.5	$\mu\text{A}$	$I_F = 0\text{mA}, V = 100\text{V}$
$I_C$	<b>Collector Current</b> OSSRD0001D	0.05	-	3	A	$I_F = 1\text{mA}, V_{CE} = 2\text{V}$
$V_{CE(sat)}$	<b>Collector-Emitter Saturation Voltage</b> OSSRD0001D	-	Yes	-	-	$I_F = 20\text{mA}, I_C = 100\text{mA}$
Riso	<b>Isolation Resistance</b> OSSRD0001D	$10^{10}$	-	-	$\Omega$	DC500 V
$C_r$	<b>Floating Capacitance</b> OSSRD0001D	-	-	3	pF	$V = 0, f = 1\text{MHz}$
$f_c$	<b>Cut-Off Frequency</b> OSSRD0001D	2	-	-	Hz	$V_{CE} = 2\text{V}, I_C = 200\text{mA}, R_L = 200\text{mA}$
$t_f$	<b>Response Time (Rise)</b> OSSRD0001D	-	-	500	$\mu\text{S}$	$V_{CE} = 2\text{V}, I_C = 20\text{mA}, R_L = 200\text{mA}$
$t_r$	<b>Response Time (Fall)</b> OSSRD0001D	-	-	200	$\mu\text{S}$	$V_{CE} = 2\text{V}, I_C = 20\text{mA}, R_L = 200\text{mA}$

OPTEK reserves the right to make changes at any time in order to improve design and to supply the best product possible.

# Solid State Relays

## 4-Pin SIP Package—VDC Input—VAC/VDC Output

### OSSRD2001D and OSSRD2002A



### OSSRD2001D

#### Characteristic Data Curves

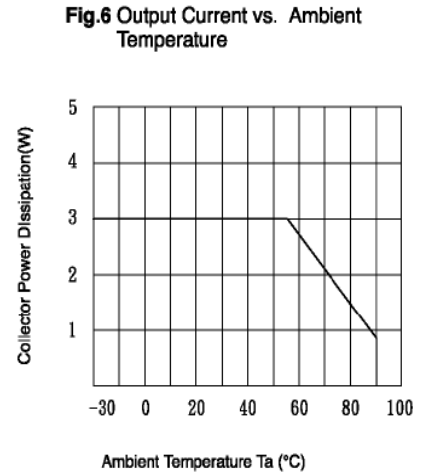
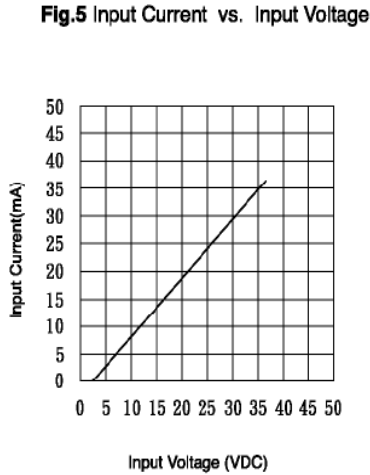
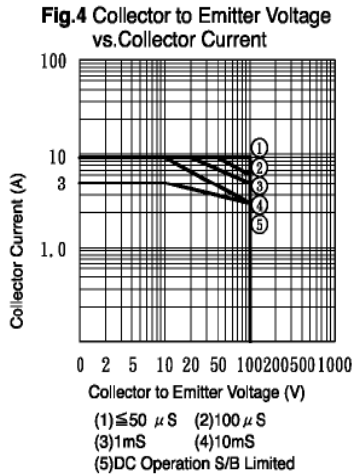
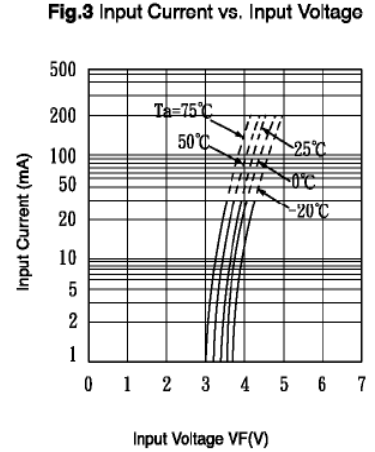
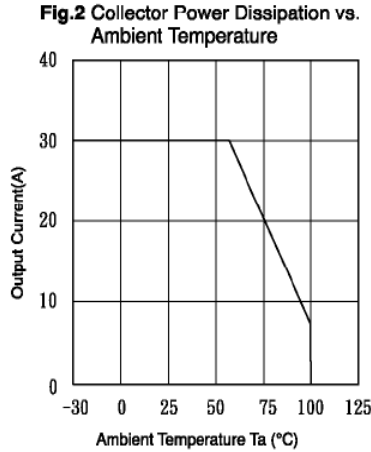
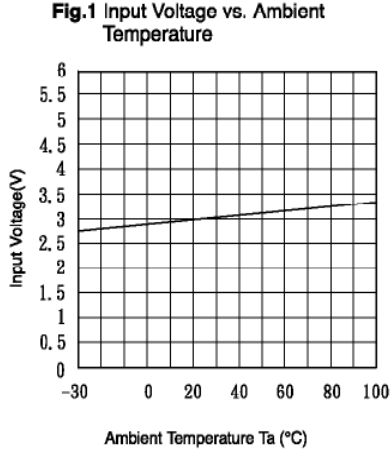

**Fig.7 Action Waveform**

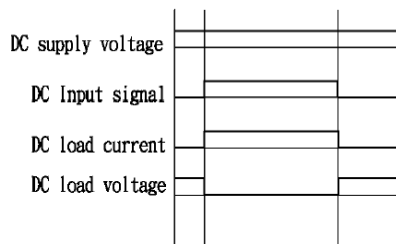

**Fig.8 WIRING DIAGRAM**

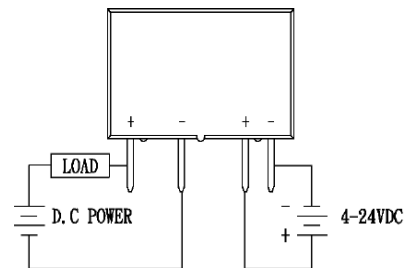

OPTEK reserves the right to make changes at any time in order to improve design and to supply the best product possible.

# Solid State Relays

## 4-Pin SIP Package—VDC Input—VAC/VDC Output

### OSSRD2001D and OSSRD2002A



## OSSRD2002A

### Characteristic Data Curves

**Fig.1** RMS On-state Current vs. Ambient Temperature

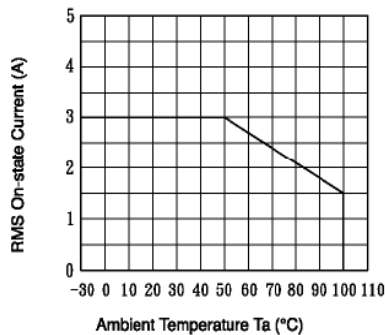

**Fig.2** Surge Current vs. Time

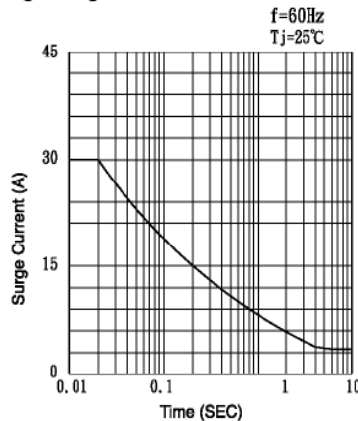

**Fig.3** Open Circuit Leak Current vs. Supply Voltage

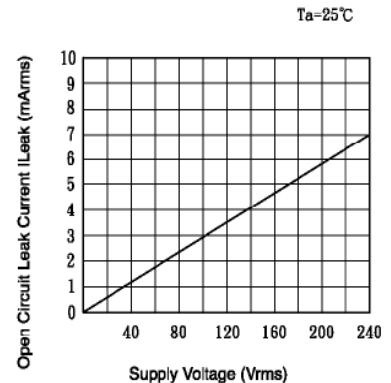

**Fig.4** RMS On-state Current vs. Case Temperature

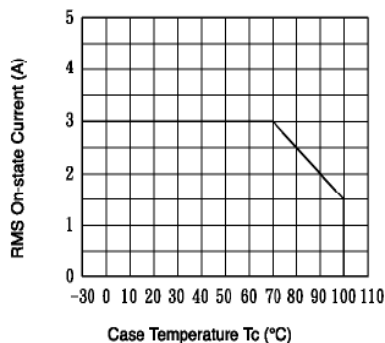

**Fig.5** Input Voltage vs. Ambient Temperature

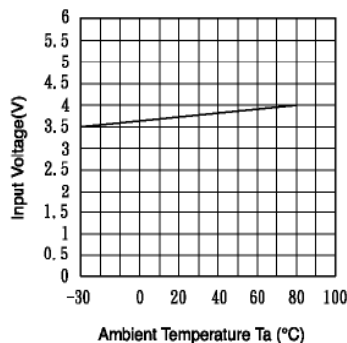

**Fig.6** Input Current vs. Input voltage

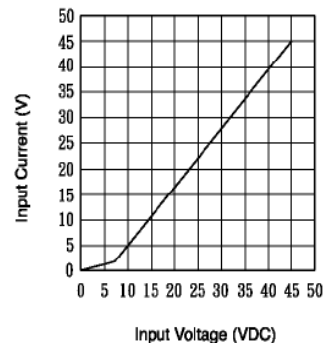

**Fig.7** Action waveform

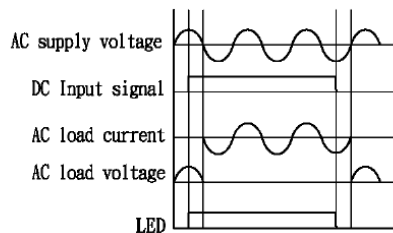

**Fig.8** WIRING DIAGRAM

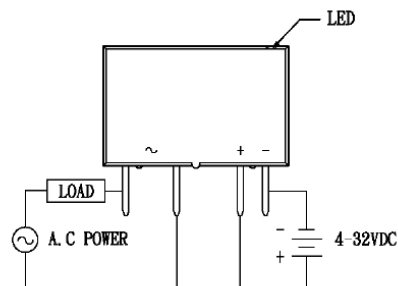

OPTEK reserves the right to make changes at any time in order to improve design and to supply the best product possible.



# Solid State Relays

## 4-Pin SIP Package—VDC Input—VAC/VDC Output

### OSSRD2001D and OSSRD2002A



#### Quality and Reliability Requirements

Parameter	Failure Criteria	Test Conditions
Room Temperature Operating Life (for light emitting diodes only)	± 20%	T <sub>A</sub> = 25°C, I <sub>F</sub> = 60mA or max. rated, Time = 1000 hours
High Humidity, High Temperature Reverse Bias	± 20%	JEDEC, Method A101-B T <sub>A</sub> = 85°C, Humidity = 85%RH, Time = 1000 hours
High Temperature Forward Bias	± 20%	JEDEC, Method A108-A T <sub>A</sub> = 70°C, I <sub>F</sub> = 20mA, Time = 1000 hours
Autoclave	0 Fail	T <sub>A</sub> = 121°C, Pressure = 15psi, Humidity = 100%
IR Reflow / Solderability Test	0 Fail	JEDEC (J-STD-020) / MIL-STD-883E, Method 2003.7
MTTF @ 90% confidence	150,000 Min.	@ 25°C, 25mADC
Moisture Sensitivity Level	MSL 1	per JDEC stnd J-STD-020B
Glass Transition of body	125°C Min.	DSC test method
Temperature Humidity-Bias	± 20%	85°C, 85%RH, 500Hrs, 80% min I <sub>ceo</sub>
Temperature Cycle	± 20%	per Method 1010.7 of MIL-STD-883E
High Temperature Storage	± 20%	85°C, 500Hrs

#### Label Identification:

#### DESCRIPTION:

Size: 3" (7.4 cm) X 2.2" (5.5 cm)  
 Lettering shall be black on white background.  
 Format shall be as:

#### Notes:

1. The DATE CODE is a 4-digit code for date of manufacture where YY is the last two digits of the year, and WW is week number of manufacture.
2. The LOT I.D. is the manufacturing location lot identification where Y is the year of manufacture, NNNN is a sequential lot identifier, and DDD is the day of the year of manufacture. – or use equivalent label format.

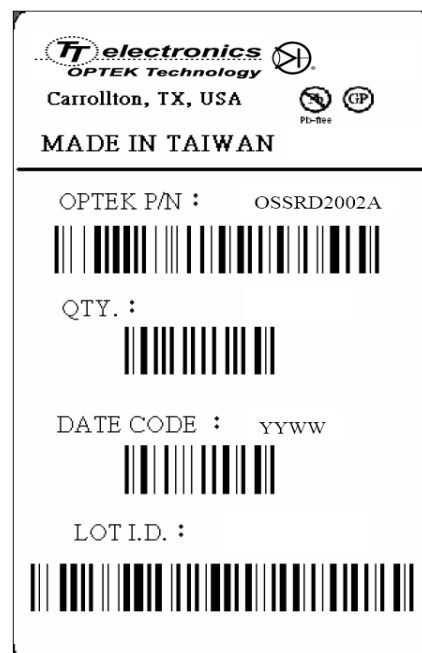

OPTEK reserves the right to make changes at any time in order to improve design and to supply the best product possible.

# Solid State Relays

## 4-Pin SIP Package—VDC Input—VAC/VDC Output

### OSSRD2001D and OSSRD2002A



### Packaging Information:

Optek's Solid-State Relays Part Numbers (4-Pin SIP)		Packaging Quantities	Tubes		Inner		Medium Carton			Large Carton		
			Qty	Weight (g)	Qty	Weight (kg)	Qty	Net Weight (kg)	Gross Weight (kg)	Qty	Net Weight (kg)	Gross Weight (kg)
		Package Type	53.5 x 7.0 x 7.5 cm		55.5 x 30.7 x 16.5 cm			55.5 x 30.7 x 23.5 cm				
SSR	OSSRD2001D, OSSRD2002A	4 Pin SIP (24mm x 37mm)	10	213	80	1.80	640	14.4	15.4	960	21.6	22.9
	OSRRD1001A - OSSRD1006A	4 Pin SIP (32mm x 24mm)	20	421	80	1.90	640	15.2	16.2	960	22.8	24.1

Optek's Solid-State Relays Part Numbers (Panel Mounts)		Packaging Quantities	Trays		Small Carton			Medium Carton			Large Carton		
			Qty	Weight (g)	Qty	Net Weight (kg)	Gross Weight (kg)	Qty	Net Weight (kg)	Gross Weight (kg)	Qty	Net Weight (kg)	Gross Weight (kg)
		Package Type	36 x 20 x 37 cm		37 x 21 x 11 cm			37 x 21 x 17 cm			37 x 21 x 32 cm		
SSR	OSSRD0001A - OSSRD0006A OSSRA0007A - OSSRA0012A	Panel Mounts (42.5mm x 58mm)	10	920	30	2.80	3.3	50	4.7	5.4	100	9.5	10.5

### Tray and Carton Packaging Specifications:

#### Tube Packaging Dimensions

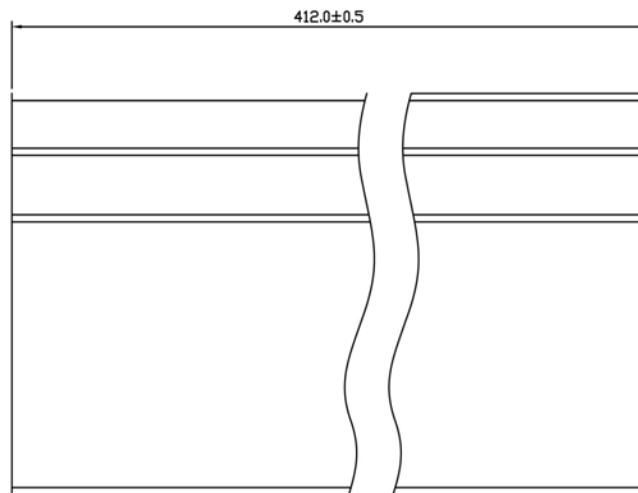
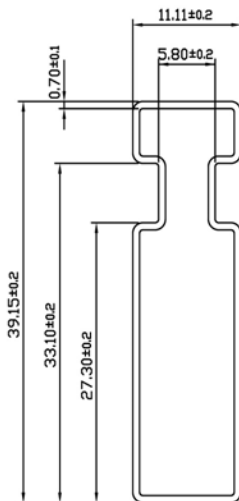

All dimensions in millimeters

OPTEK reserves the right to make changes at any time in order to improve design and to supply the best product possible.

# Solid State Relays

## 4-Pin SIP Package—VDC Input—VAC/VDC Output

### OSSRD2001D and OSSRD2002A



### Tray and Carton Packaging Specifications (Cont.):

#### Carton Packaging Dimensions

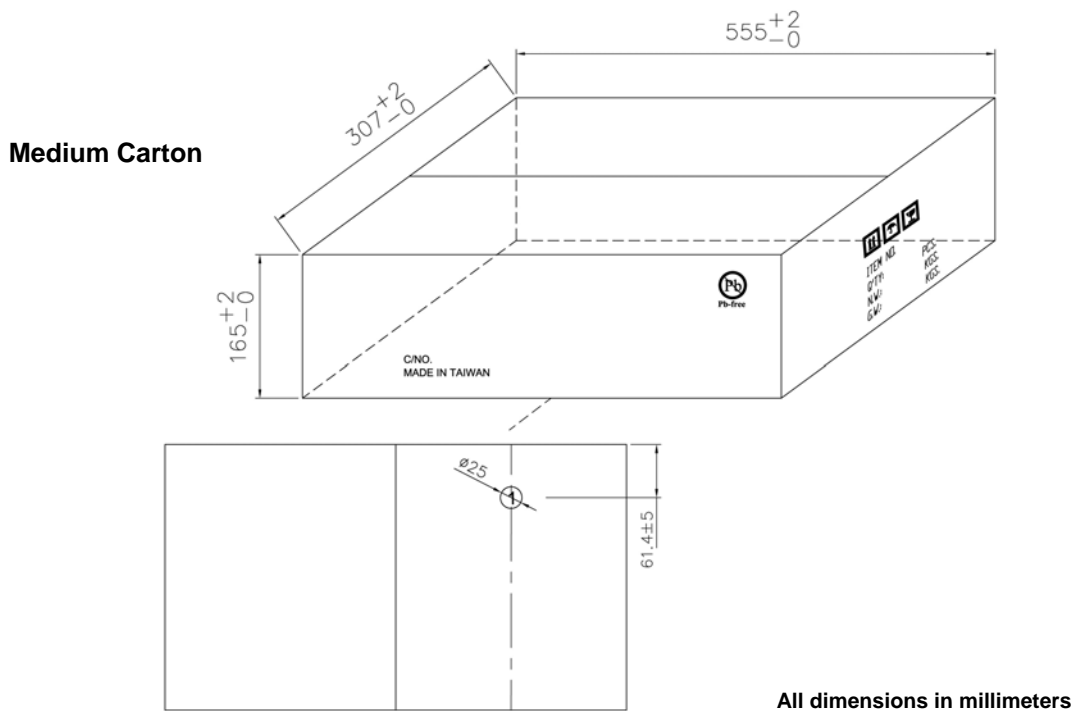
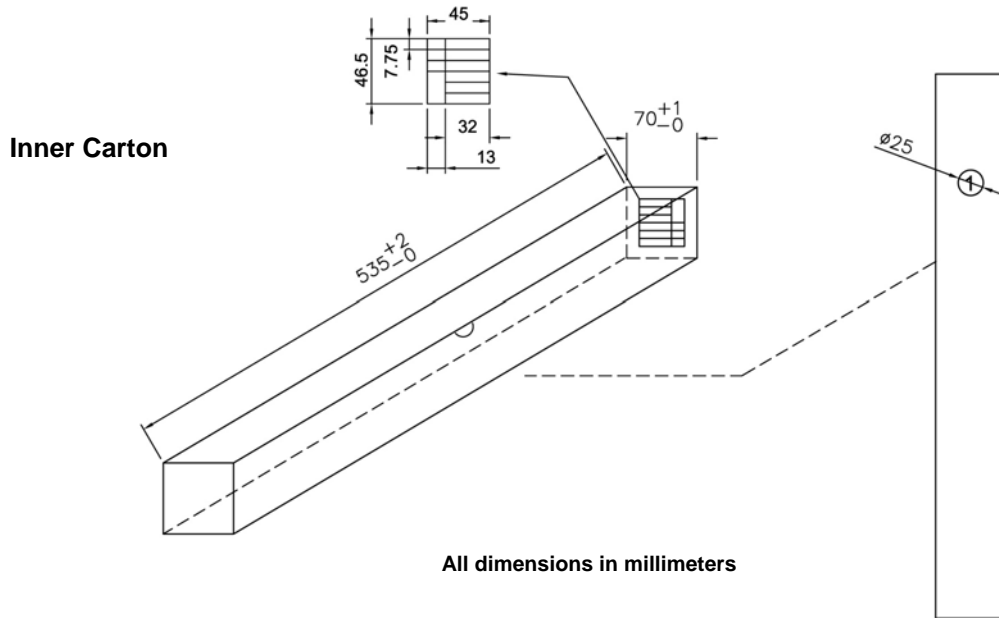

OPTEK reserves the right to make changes at any time in order to improve design and to supply the best product possible.

# Solid State Relays

## 4-Pin SIP Package—VDC Input—VAC/VDC Output

### OSSRD2001D and OSSRD2002A



### Tray and Carton Packaging Specifications (Cont.):

#### Carton Packaging Dimensions

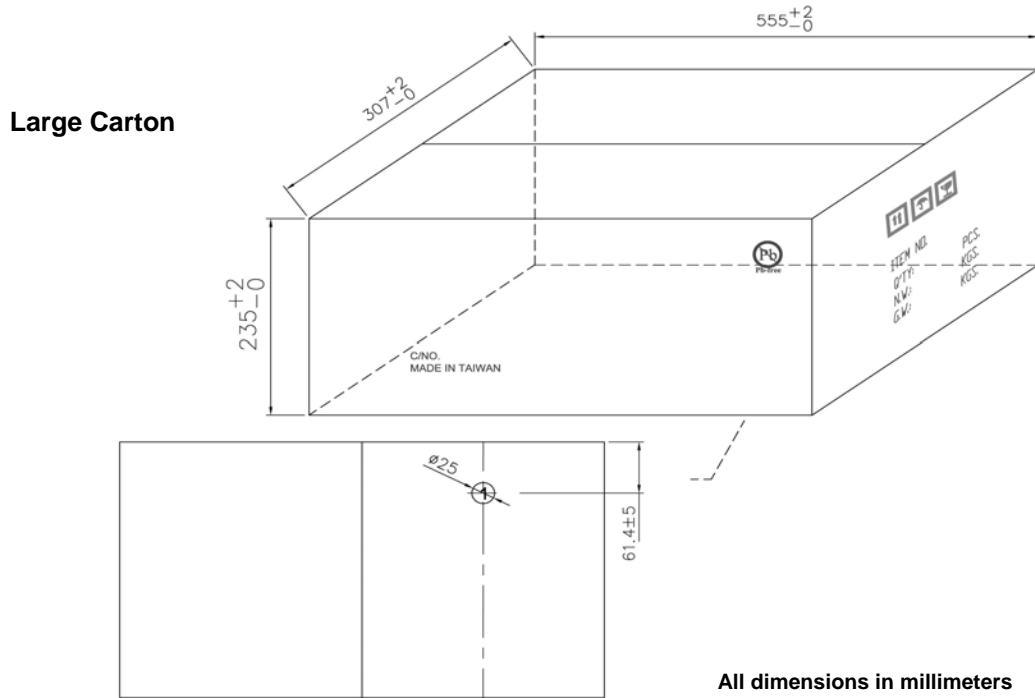

OPTEK reserves the right to make changes at any time in order to improve design and to supply the best product possible.