

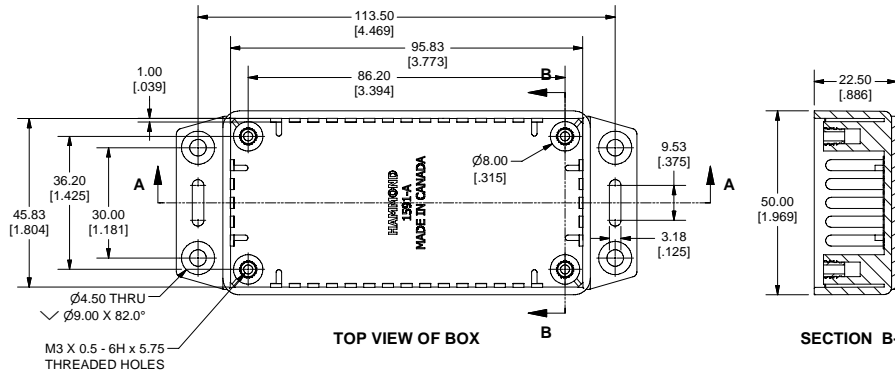

SIDE VIEW OF BOX

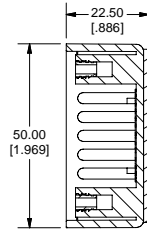

TOP VIEW OF BOX



SECTION B-B

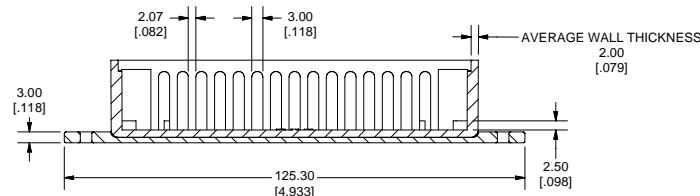
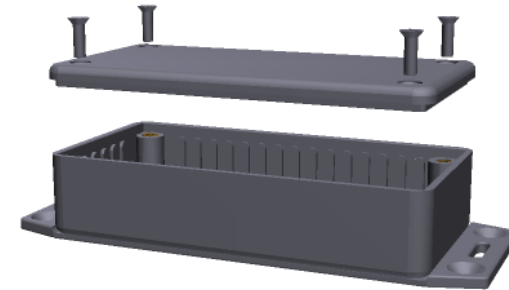

SECTION A-A

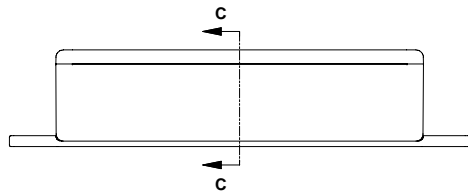

SIDE VIEW OF ASSEMBLY

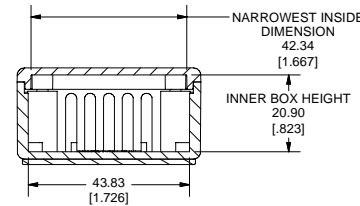

SECTION C-C

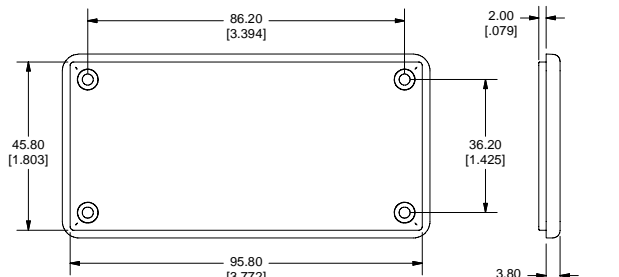

BOTTOM VIEW OF LID

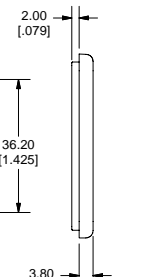

SIDE VIEW OF LID

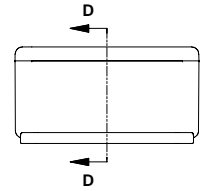

END VIEW OF ASSEMBLY

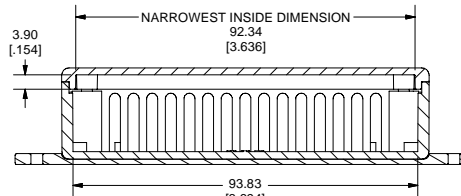

SECTION D-D

Note:
Enclosures can be Factory Modified (Milling, Drilling, Printing etc.)
Contact Factory mjm@hammondmfg.com for quotes
Solid models of this enclosure available in STEP or IGES Format.

PART NUMBERS		
1591A Flanged Box Enclosures		
Material	Colour	Part Number
FR ABS	Black	1591AF2BK
UL94 - V0	Grey	1591AF2GY
GP ABS	Black	1591AF2SBK
	Grey	1591AF2SGY
Accessories		
	Description	Part Number
Universal Use	PC Board Card Adapters	See Accessories Section
	Clear Lids - clear, flame retardant polycarbonate - Lid ONLY	1591AC
FR ABS	Replacement Screws, Flat Head Phillips	1591MS100
	Nickel Plated Pkg of 100	1591MS100BK (Black)
GP ABS	Self Tapping Pkg of 100	1591TS100
		1591TS100BK (Black)
Recommended Torque on Fasteners (no lubrication)		
	M3 - 0.5 x 10mm Screws	30-40 cN*m
	#4 x 0.5 Screws	30-40 cN*m

