

HEXFRED[®], Ultrafast Soft Recovery Diode, 4 A

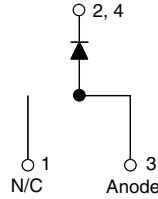

TO-252AA (D-PAK)

FEATURES

- Ultrafast recovery time
- Ultrasoft recovery
- Very low I_{RRM}
- Very low Q_{rr}
- Guaranteed avalanche
- Specified at operating temperature
- AEC-Q101 qualified
- Meets JESD 201 class 2 whisker test
- Meets MSL level 1, per J-STD-020, LF maximum peak of 260 °C
- Material categorization: for definitions of compliance please see www.vishay.com/doc?99912

RoHS
COMPLIANT
HALOGEN
FREE

PRODUCT SUMMARY	
Package	TO-252AA (D-PAK)
$I_{F(AV)}$	4 A
V_R	600 V
V_F at I_F	1.4 V
t_{rr} typ.	17 ns
T_J max.	150 °C
Diode variation	Single die

BENEFITS

- Reduced RFI and EMI
- Reduced power loss in diode and switching transistor
- Higher frequency operation
- Reduced snubbing
- Reduced parts count

DESCRIPTION / APPLICATIONS

These diodes are optimized to reduce losses and EMI / RFI in high frequency power conditioning systems. The softness of the recovery eliminates the need for a snubber in most applications. These devices are ideally suited for freewheeling, flyback, power converters, motor drives, and other applications where high speed and reduced switching losses are design requirements.

ABSOLUTE MAXIMUM RATINGS				
PARAMETER	SYMBOL	TEST CONDITIONS	VALUES	UNITS
Cathode to anode voltage	V_{RRM}		600	V
Maximum continuous forward current	$I_{F(AV)}$	$T_C = 100\text{ °C}$	4	A
Single pulse forward current	I_{FSM}		25	
Repetitive peak forward current	I_{FRM}	$T_C = 116\text{ °C}$	16	
Maximum power dissipation	P_D	$T_C = 100\text{ °C}$	10	W
Operating junction and storage temperatures	T_J, T_{Stg}		-55 to +150	°C



ELECTRICAL SPECIFICATIONS ($T_J = 25\text{ }^\circ\text{C}$ unless otherwise specified)

PARAMETER	SYMBOL	TEST CONDITIONS	MIN.	TYP.	MAX.	UNITS
Breakdown voltage, blocking voltage	V_{BR}, V_R	$I_R = 100\text{ }\mu\text{A}$	600	-	-	V
Forward voltage See fig. 1	V_F	$I_F = 4\text{ A}$	-	1.5	1.8	
		$I_F = 8\text{ A}$	-	1.8	2.2	
		$I_F = 4\text{ A}, T_J = 125\text{ }^\circ\text{C}$	-	1.4	1.7	
Maximum reverse leakage current	I_R	$V_R = V_R$ rated	-	0.17	3.0	μA
		$T_J = 125\text{ }^\circ\text{C}, V_R = 0.8 \times V_R$ rated	-	44	300	
Junction capacitance	C_T	$V_R = 200\text{ V}$	-	4	8	pF
Series inductance	L_S	Measured lead to lead 5 mm from package body	-	8.0	-	nH

DYNAMIC RECOVERY CHARACTERISTICS ($T_C = 25\text{ }^\circ\text{C}$ unless otherwise specified)

PARAMETER	SYMBOL	TEST CONDITIONS	MIN.	TYP.	MAX.	UNITS
Reverse recovery time	t_{rr}	$I_F = 1.0\text{ A}, di_F/dt = 200\text{ A}/\mu\text{A}, V_R = 30\text{ V}$	-	17	-	ns
		$T_J = 25\text{ }^\circ\text{C}$	-	28	42	
		$T_J = 125\text{ }^\circ\text{C}$	-	38	57	
Peak recovery current	I_{RRM}	$T_J = 25\text{ }^\circ\text{C}$	-	2.9	5.2	A
		$T_J = 125\text{ }^\circ\text{C}$	-	3.7	6.7	
Reverse recovery charge	Q_{rr}	$T_J = 25\text{ }^\circ\text{C}$	-	40	60	nC
		$T_J = 125\text{ }^\circ\text{C}$	-	70	105	
Rate of fall of recovery current	$di_{(rec)M}/dt$	$T_J = 25\text{ }^\circ\text{C}$	-	280	-	A/ μs
		$T_J = 125\text{ }^\circ\text{C}$	-	235	-	

THERMAL - MECHANICAL SPECIFICATIONS

PARAMETER	SYMBOL	TEST CONDITIONS	MIN.	TYP.	MAX.	UNITS
Maximum junction and storage temperature range	T_J, T_{Stg}		-55	-	150	$^\circ\text{C}$
Thermal resistance, junction to case	R_{thJC}		-	-	5.0	$^\circ\text{C}/\text{W}$
Thermal resistance, junction to ambient	R_{thJA}	Typical socket mount	-	-	80	
Weight			-	2.0	-	g
			-	0.07	-	oz.
Mounting torque			6.0 (5.0)	-	12 (10)	kgf · cm (lbf · in)
Marking device		Case style TO-252AA (D-PAK)	HFA04SD60SH			

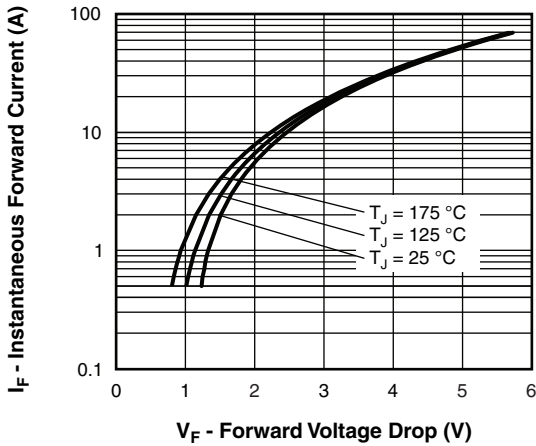

Fig. 1 - Typical Forward Voltage Drop Characteristics

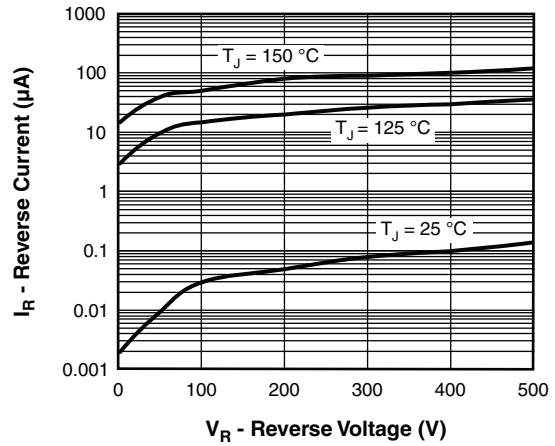

Fig. 2 - Typical Values of Reverse Current vs. Reverse Voltage

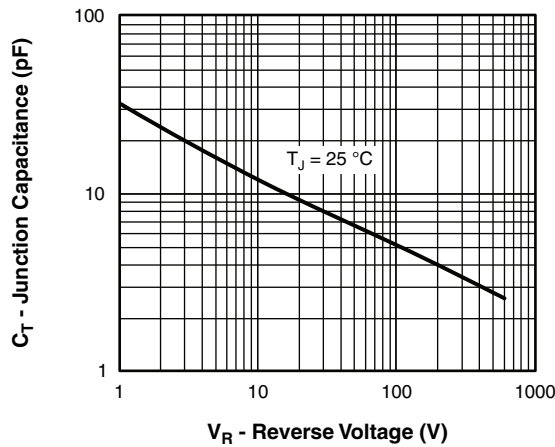

Fig. 3 - Typical Junction Capacitance vs. Reverse Voltage

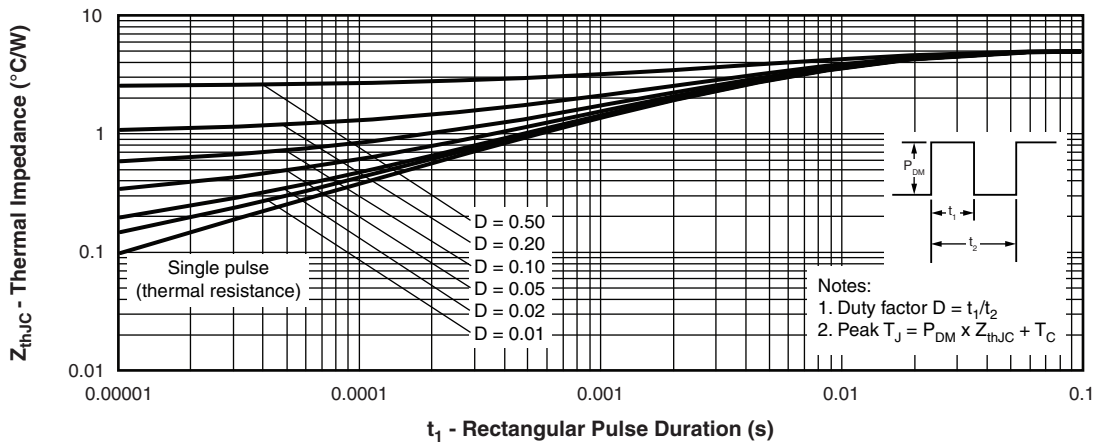

Fig. 4 - Maximum Thermal Impedance Z_{thJC} Characteristics

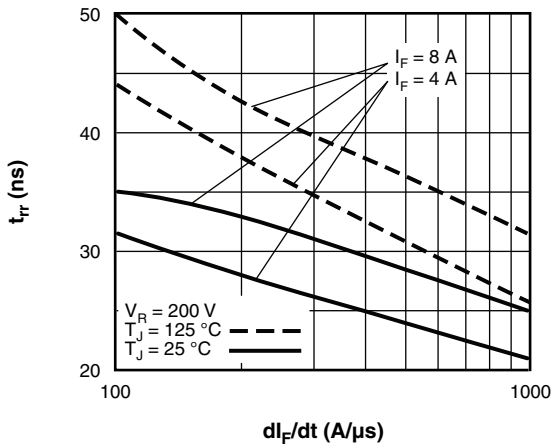

Fig. 5 - Typical Reverse Recovery Time vs. di_F/dt

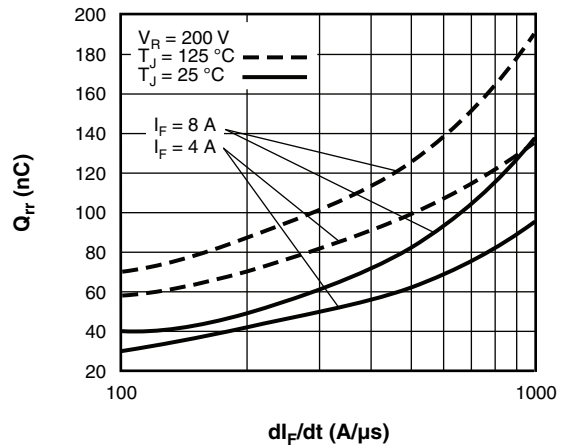

Fig. 7 - Typical Stored Charge vs. di_F/dt

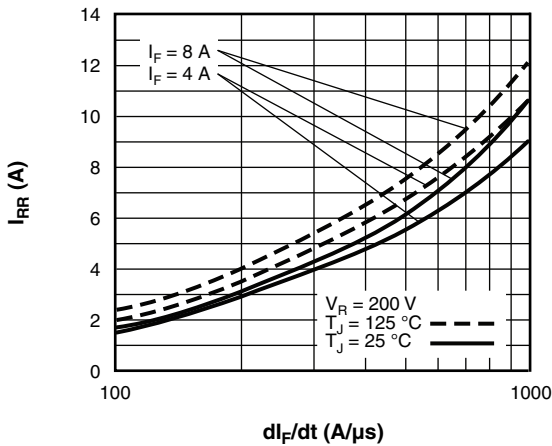

Fig. 6 - Typical Recovery Current vs. di_F/dt

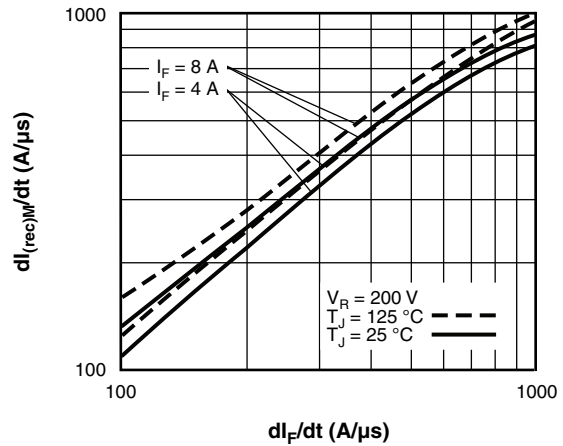

Fig. 8 - Typical $di_{(rec)M}/dt$ vs. di_F/dt

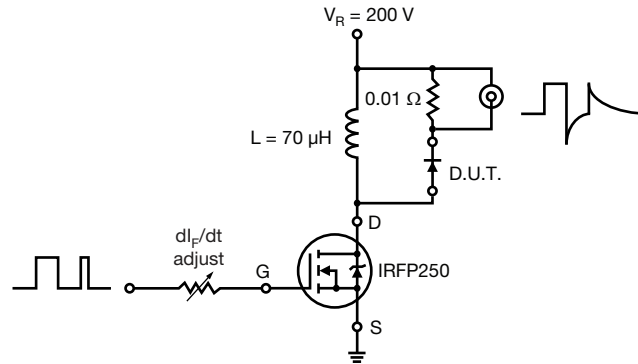
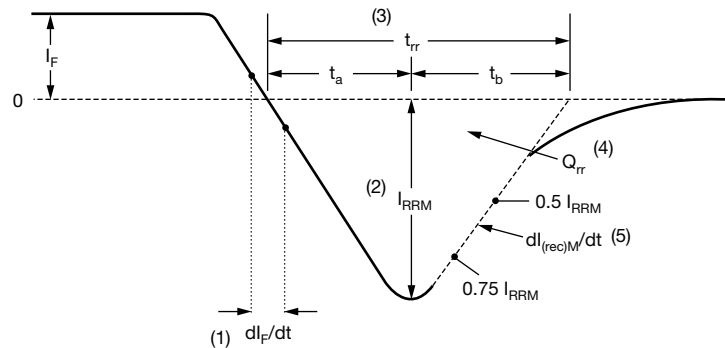

Fig. 9 - Reverse Recovery Parameter Test Circuit



- (1) di_F/dt - rate of change of current through zero crossing
- (2) I_{RRM} - peak reverse recovery current
- (3) t_{rr} - reverse recovery time measured from zero crossing point of negative going I_F to point where a line passing through $0.75 I_{RRM}$ and $0.50 I_{RRM}$ extrapolated to zero current.
- (4) Q_{rr} - area under curve defined by t_{rr} and I_{RRM}
- (5) $di_{(rec)M}/dt$ - peak rate of change of current during t_b portion of t_{rr}

$$Q_{rr} = \frac{t_{rr} \times I_{RRM}}{2}$$

Fig. 10 - Reverse Recovery Waveform and Definitions



ORDERING INFORMATION TABLE

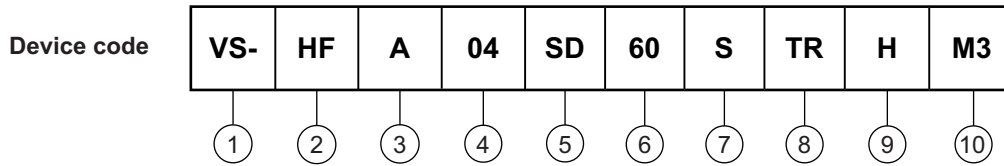

- 1** - Vishay Semiconductors product
- 2** - HEXFRED® family
- 3** - Electron irradiated
- 4** - Current rating (04 = 4 A)
- 5** - D-PAK
- 6** - Voltage rating (60 = 600 V)
- 7** - S = D-PAK
- 8** -
 - TR = tape and reel
 - R = tape and reel (right oriented)
 - L = tape and reel (left oriented)
- 9** - H = AEC-Q101 qualified
- 10** - Environmental digit:
 - M3 = halogen-free, RoHS-compliant, and terminations lead (Pb)-free

ORDERING INFORMATION (Example)			
PREFERRED P/N	QUANTITY PER T/R	MINIMUM ORDER QUANTITY	PACKAGING DESCRIPTION
VS-HFA04SD60SHM3	75	3000	Antistatic plastic tube
VS-HFA04SD60STRHM3	2000	2000	13" diameter reel
VS-HFA04SD60STRRHM3	3000	3000	13" diameter reel
VS-HFA04SD60STRLHM3	3000	3000	13" diameter reel

LINKS TO RELATED DOCUMENTS	
Dimensions	www.vishay.com/doc?95519
Part marking information	www.vishay.com/doc?95518
Packaging information	www.vishay.com/doc?95033



Disclaimer

ALL PRODUCT, PRODUCT SPECIFICATIONS AND DATA ARE SUBJECT TO CHANGE WITHOUT NOTICE TO IMPROVE RELIABILITY, FUNCTION OR DESIGN OR OTHERWISE.

Vishay Intertechnology, Inc., its affiliates, agents, and employees, and all persons acting on its or their behalf (collectively, "Vishay"), disclaim any and all liability for any errors, inaccuracies or incompleteness contained in any datasheet or in any other disclosure relating to any product.

Vishay makes no warranty, representation or guarantee regarding the suitability of the products for any particular purpose or the continuing production of any product. To the maximum extent permitted by applicable law, Vishay disclaims (i) any and all liability arising out of the application or use of any product, (ii) any and all liability, including without limitation special, consequential or incidental damages, and (iii) any and all implied warranties, including warranties of fitness for particular purpose, non-infringement and merchantability.

Statements regarding the suitability of products for certain types of applications are based on Vishay's knowledge of typical requirements that are often placed on Vishay products in generic applications. Such statements are not binding statements about the suitability of products for a particular application. It is the customer's responsibility to validate that a particular product with the properties described in the product specification is suitable for use in a particular application. Parameters provided in datasheets and / or specifications may vary in different applications and performance may vary over time. All operating parameters, including typical parameters, must be validated for each customer application by the customer's technical experts. Product specifications do not expand or otherwise modify Vishay's terms and conditions of purchase, including but not limited to the warranty expressed therein.

Except as expressly indicated in writing, Vishay products are not designed for use in medical, life-saving, or life-sustaining applications or for any other application in which the failure of the Vishay product could result in personal injury or death. Customers using or selling Vishay products not expressly indicated for use in such applications do so at their own risk. Please contact authorized Vishay personnel to obtain written terms and conditions regarding products designed for such applications.

No license, express or implied, by estoppel or otherwise, to any intellectual property rights is granted by this document or by any conduct of Vishay. Product names and markings noted herein may be trademarks of their respective owners.