

DESCRIPTION: HIGH DENSITY - MACHINED CONTACTS - RIGHT ANGLE

**MATERIALS AND FINISH:**

SHELL: STEEL MATERIAL, NICKEL FINISH  
 INSULATOR: (SEE CHART) =260°C, UL 94V-0 RATED, BLACK  
 CONTACT MATERIAL: BRASS  
 CONTACT FINISH: SELECTIVE GOLD FINISHED

**ELECTRICAL:**

CONTACT CURRENT RATING: 5 AMPS  
 CONTACT RESISTANCE: 30 Milliohms Max.  
 DIELECTRIC WITHSTANDING VOLTAGE: 1,000VAC Min.  
 INSULATION RESISTANCE: 5,000 Megohms Min.  
 TEMPERATURE RATING: -55° ~ +105° C

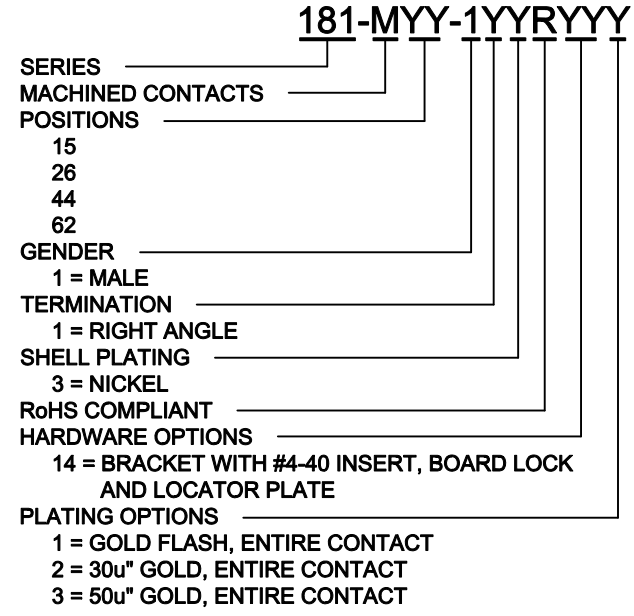
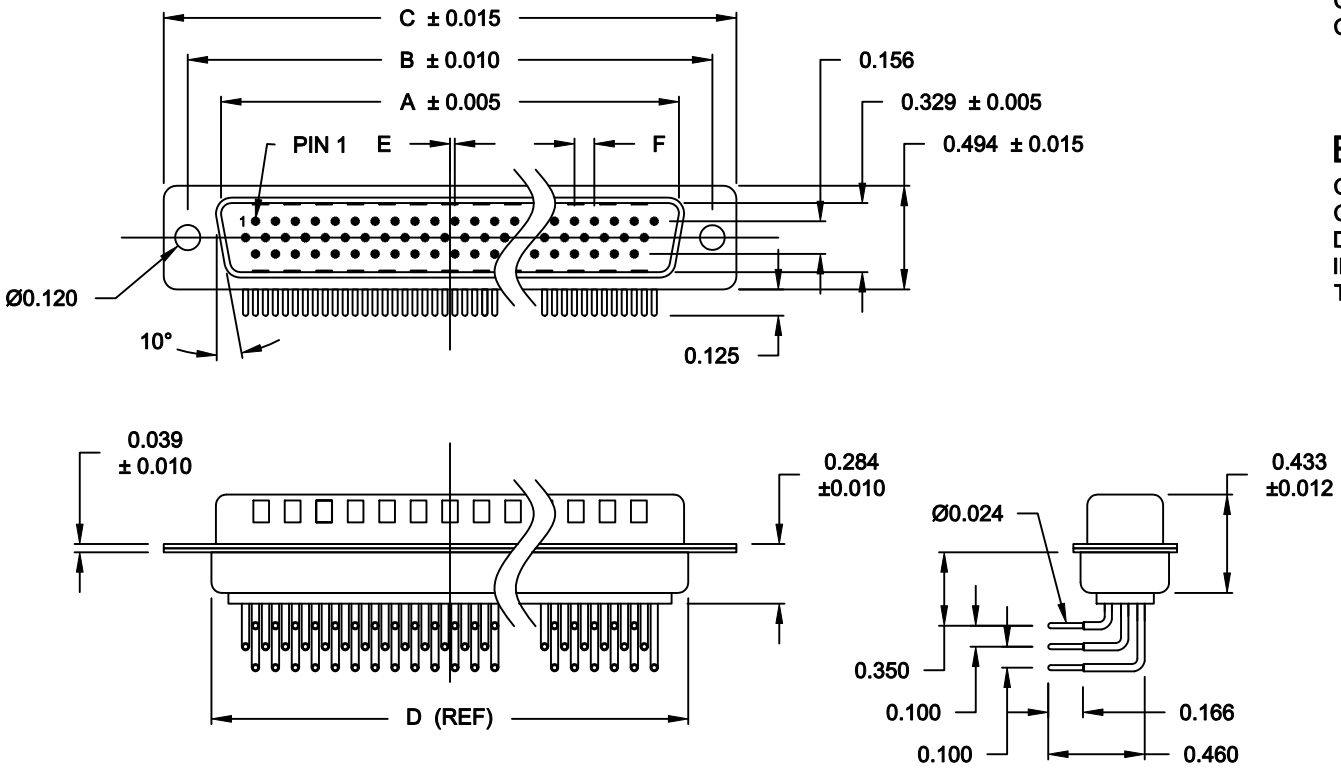

DIMENSIONS (IN.)							Insulator Material
No. OF PINS	A	B	C	D	E	F	
15	0.666	0.984	1.213	0.756	0.010	0.090	PA9T
26	0.994	1.312	1.541	1.091	0.020	0.090	PA9T
44	1.534	1.852	2.088	1.618	0.020	0.090	PA9T
62	2.182	2.500	2.729	2.256	0.023	0.095	PA6T

DO NOT SCALE FROM DRAWING

	THESE DRAWINGS AND SPECIFICATIONS ARE THE PROPERTY OF NorComp AND SHALL NOT BE REPRODUCED, COPIED OR USED AS THE BASIS FOR THE MANUFACTURE OF SALE OF APPARATUS WITHOUT WRITTEN PERMISSION.		DRAWN: C. SMITH	DATE: 03-16-07
			CHECKED:	DATE:
		SCALE: 1 : 1	SHEET 1 OF 4	REV 16
		DWG NO. 181-MYY-1YYRYYY		

RoHS COMPLIANT

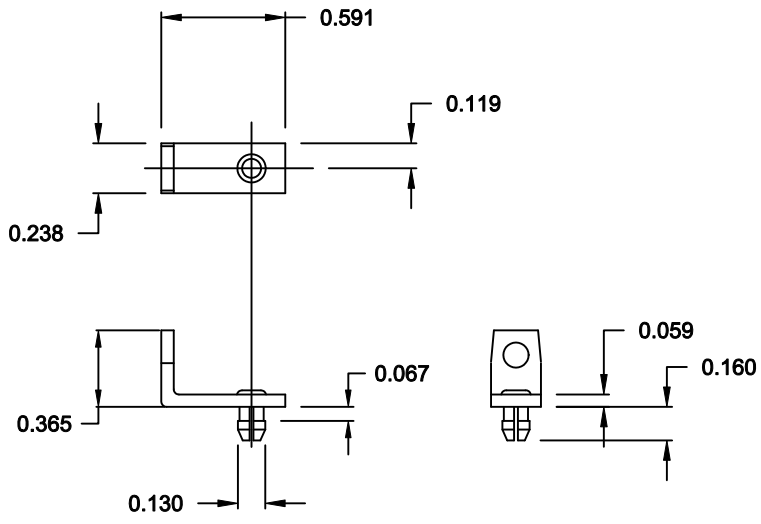

MOUNTING BRACKET WITH BOARD LOCK

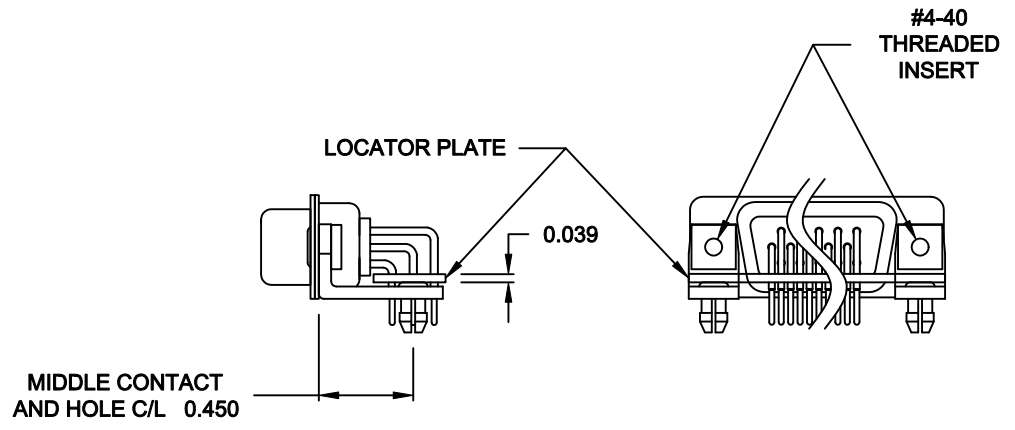

BRACKETS MOUNTED ON CONNECTOR WITH LOCATOR PLATE

FOR CLARITY  
HIDDEN LINES  
NOT SHOWN

MATERIAL: COLD ROLLED STEEL  
PLATING: CLEAR ZINC

	THESE DRAWINGS AND SPECIFICATIONS ARE THE PROPERTY OF NorComp AND SHALL NOT BE REPRODUCED, COPIED OR USED AS THE BASIS FOR THE MANUFACTURE OF SALE OF APPARATUS WITHOUT WRITTEN PERMISSION.		DRAWN: <b>PAM JENKINS</b>	DATE: 11-28-05
			CHECKED:	DATE:
<b>NorComp</b>		SCALE: 1 : 1	SHEET 2 OF 4	REV 16
		DWG NO. 181-MYY-1YYRYYY		

NOTE: MALE LOCATOR PLATE SHOWN  
FLIP FOR FEMALE

MATERIAL: INSULATION PAPER  
0.039" THICK

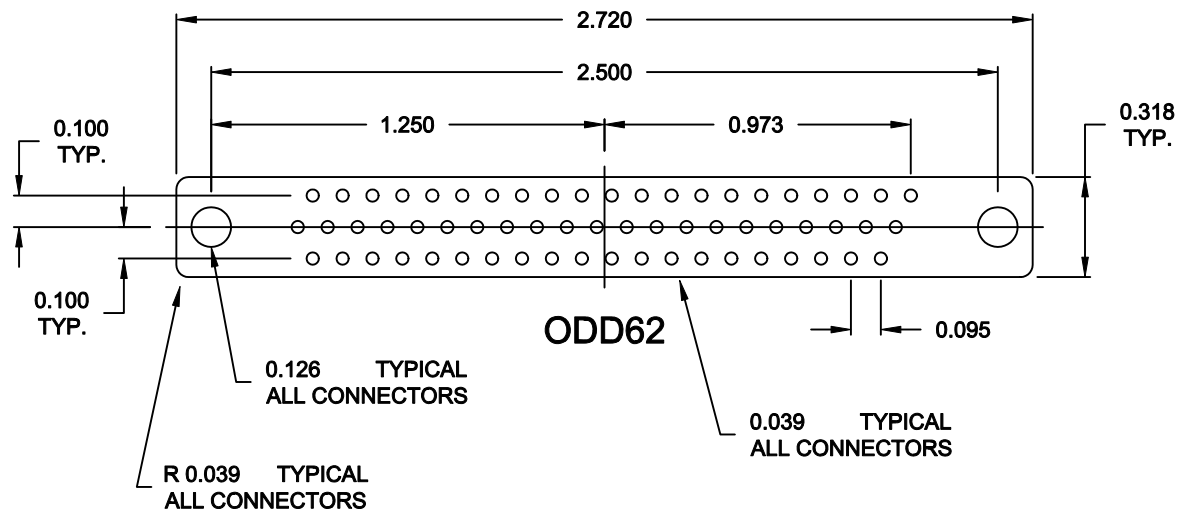
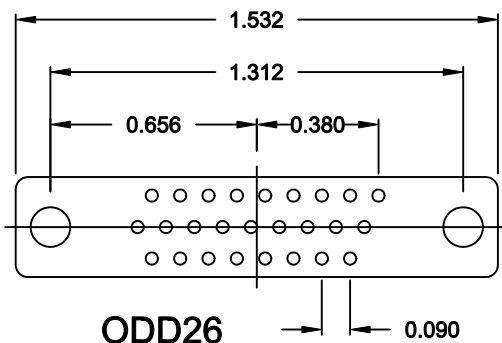
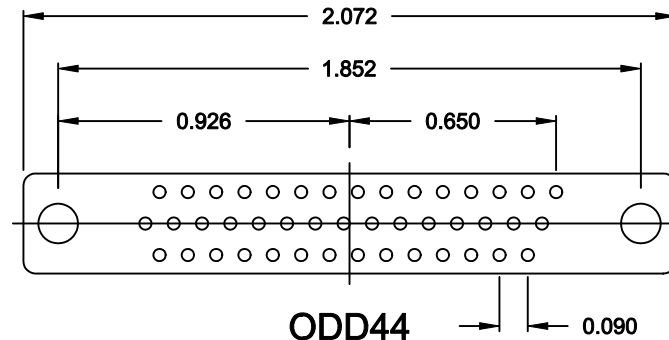
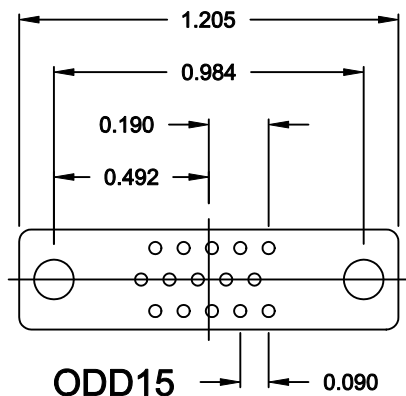

DO NOT SCALE FROM DRAWING

	THESE DRAWINGS AND SPECIFICATIONS ARE THE PROPERTY OF NorComp AND SHALL NOT BE REPRODUCED, COPIED OR USED AS THE BASIS FOR THE MANUFACTURE OF SALE OF APPARATUS WITHOUT WRITTEN PERMISSION.		DRAWN: C. SMITH	DATE: 02-18-08
			CHECKED:	DATE:
<h1>NorComp</h1>		SCALE: 1.5 : 1	SHEET 3 OF 4	REV 16
		DWG NO. 181-MYY-1YYRYYY		

RoHS COMPLIANT

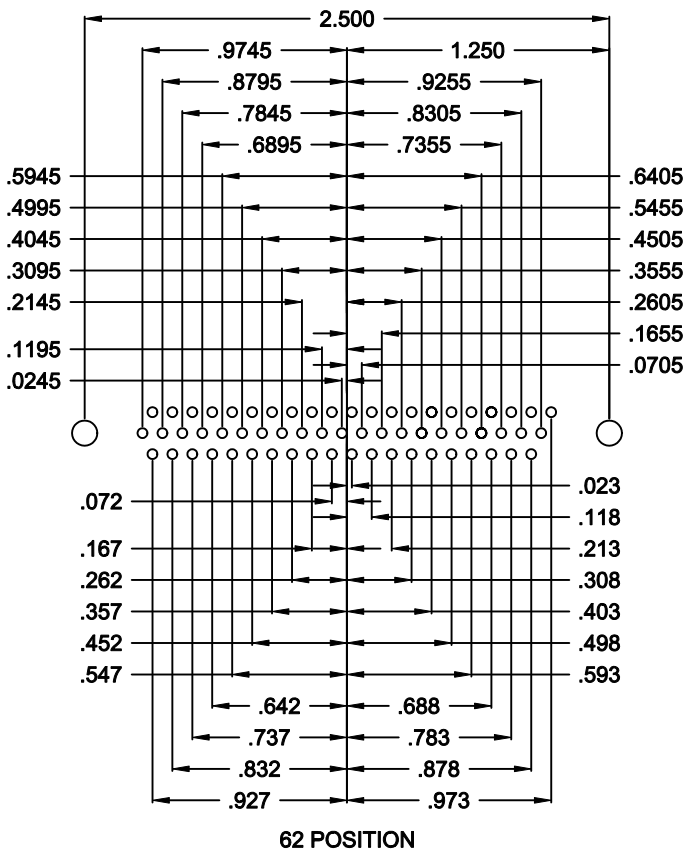
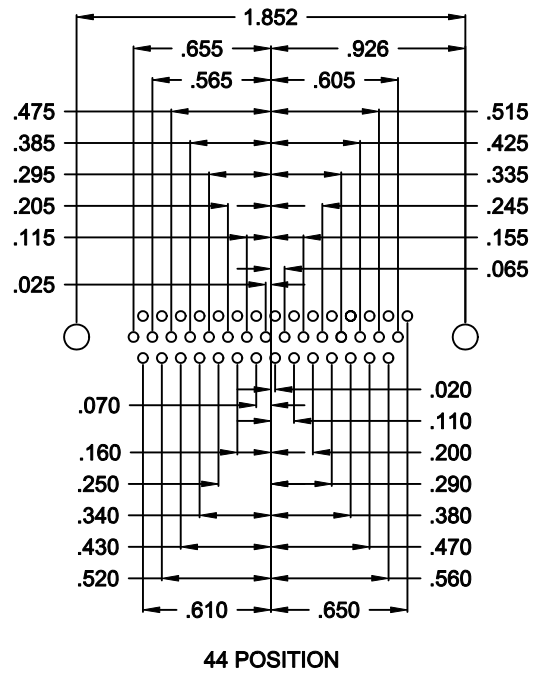
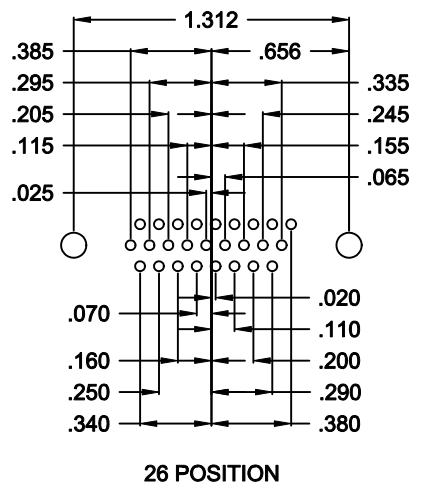
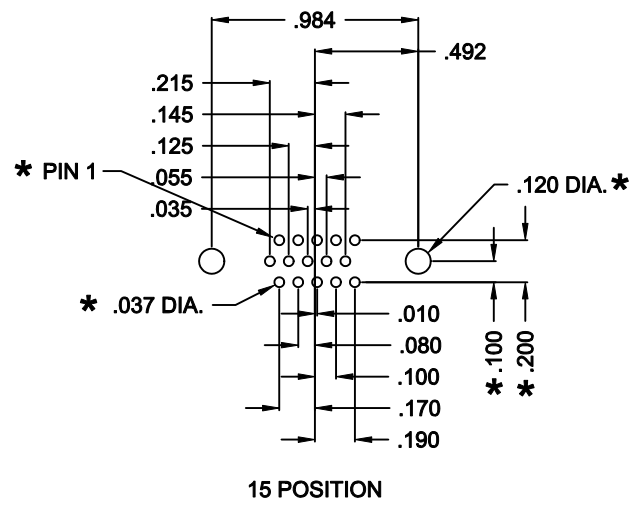

\* TYP. ON ALL SIZES

DO NOT SCALE FROM DRAWING

	THESE DRAWINGS AND SPECIFICATIONS ARE THE PROPERTY OF NorComp AND SHALL NOT BE REPRODUCED, COPIED OR USED AS THE BASIS FOR THE MANUFACTURE OF SALE OF APPARATUS WITHOUT WRITTEN PERMISSION.		DRAWN: <b>C. SMITH</b>	DATE: <b>03-16-07</b>
			CHECKED:	DATE:
<b>NorComp</b>		SCALE: <b>1 : 1</b>	SHEET <b>4</b>	OF <b>4</b>
		DWG NO. <b>181-MYY-1YYRYYY</b>		