



Is Now Part of



ON Semiconductor®

To learn more about ON Semiconductor, please visit our website at

www.onsemi.com

ON Semiconductor and the ON Semiconductor logo are trademarks of Semiconductor Components Industries, LLC dba ON Semiconductor or its subsidiaries in the United States and/or other countries. ON Semiconductor owns the rights to a number of patents, trademarks, copyrights, trade secrets, and other intellectual property. A listing of ON Semiconductor's product/patent coverage may be accessed at www.onsemi.com/site/pdf/Patent-Marking.pdf. ON Semiconductor reserves the right to make changes without further notice to any products herein. ON Semiconductor makes no warranty, representation or guarantee regarding the suitability of its products for any particular purpose, nor does ON Semiconductor assume any liability arising out of the application or use of any product or circuit, and specifically disclaims any and all liability, including without limitation special, consequential or incidental damages. Buyer is responsible for its products and applications using ON Semiconductor products, including compliance with all laws, regulations and safety requirements or standards, regardless of any support or applications information provided by ON Semiconductor. "Typical" parameters which may be provided in ON Semiconductor data sheets and/or specifications can and do vary in different applications and actual performance may vary over time. All operating parameters, including "Typicals" must be validated for each customer application by customer's technical experts. ON Semiconductor does not convey any license under its patent rights nor the rights of others. ON Semiconductor products are not designed, intended, or authorized for use as a critical component in life support systems or any FDA Class 3 medical devices or medical devices with a same or similar classification in a foreign jurisdiction or any devices intended for implantation in the human body. Should Buyer purchase or use ON Semiconductor products for any such unintended or unauthorized application, Buyer shall indemnify and hold ON Semiconductor and its officers, employees, subsidiaries, affiliates, and distributors harmless against all claims, costs, damages, and expenses, and reasonable attorney fees arising out of, directly or indirectly, any claim of personal injury or death associated with such unintended or unauthorized use, even if such claim alleges that ON Semiconductor was negligent regarding the design or manufacture of the part. ON Semiconductor is an Equal Opportunity/Affirmative Action Employer. This literature is subject to all applicable copyright laws and is not for resale in any manner.



FPF1C2P5MF07AM

F1 Module solution for PV-Application

General Description

Fairchild's brand-new DC-AC module is designed for a power stage that needs more compact design. And the Press-fit technology provides simple and reliable mounting. This module is optimized for the application such as solar inverter where a high efficiency and robust design are needed.

Electrical Features

- High Efficiency
- Low Conduction and Switching losses
- Low $V_{CE(sat)}$: 1.1 V typ. @ $I_c = 30$ A
- Low $R_{DS(ON)}$: 90 m Ω max.
- Fast Recovery Body Diode

Mechanical Features

- Compact size : F1 Package
- Press-fit contact technology

Applications

- Solar Inverter

Certification

- UL approved (E209204)

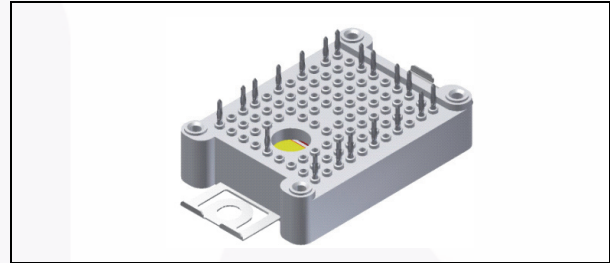

Package Code: F1

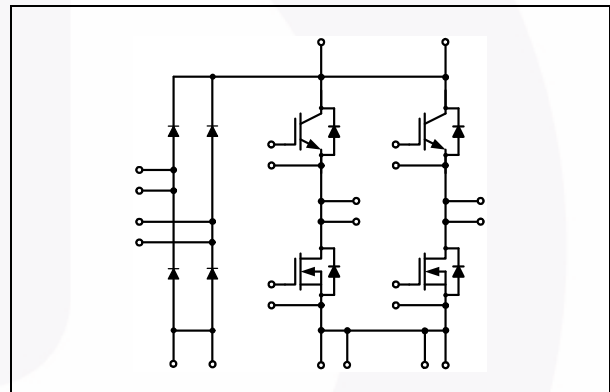

Internal Circuit Diagram

Absolute Maximum Ratings $T_C = 25^\circ\text{C}$ unless otherwise noted.

Symbol	Description	Rating	Units
Rectifier Diode			
V_{RRM}	Peak Repetitive Reverse Voltage	620	V
I_{Fav}	Diode Continuous Forward Current @ $T_C = 80^\circ\text{C}$	27	A
I_{FSM}	Diode Maximum Forward Surge Current	245	A
I^2t	I^2t value	300	A^2s
P_D	Maximum Power Dissipation @ $T_C = 25^\circ\text{C}$	77	W
T_J	Operating Junction Temperature	-40 to +150	$^\circ\text{C}$

Absolute Maximum Ratings $T_C = 25^\circ\text{C}$ unless otherwise noted. (Continued)

Symbol	Description	Rating	Units	
High-side IGBT				
V_{CES}	Collector-Emitter Voltage	620	V	
V_{GES}	Gate-Emitter Voltage	± 20	V	
I_C	Collector Current @ $T_C = 80^\circ\text{C}$	39	A	
I_{CM}	Pulsed Collector Current	90	A	
I_F	Diode Continuous Forward Current @ $T_C = 80^\circ\text{C}$	22	A	
I_{FM}	Diode Maximum Forward Current	90	A	
P_D	Maximum Power Dissipation @ $T_C = 25^\circ\text{C}$	231	W	
T_J	Operating Junction Temperature	-40 to +150	$^\circ\text{C}$	
Low-side MOSFET				
V_{DSS}	Drain-Source Voltage	620	V	
V_{GSS}	Gate-Source Voltage	± 20	V	
I_D	Continuous Drain Current	@ $T_C = 25^\circ\text{C}$	36	A
		@ $T_C = 80^\circ\text{C}$	27	A
I_{DM}	Pulsed Drain Current Limited by T_J max.	156	A	
I_S	Continuous Source-Drain Forward Current	36	A	
I_{SM}	Maximum Pulsed Source-Drain Forward Current	156	A	
P_D	Maximum Power Dissipation @ $T_C = 25^\circ\text{C}$	250	W	
T_J	Operating Junction Temperature	-40 to +150	$^\circ\text{C}$	
Module				
T_{STG}	Storage Temperature	-40 to +125	$^\circ\text{C}$	
V_{ISO}	Isolation Voltage @ AC 1 _{MIN}	2500	V	
Iso._Material	Internal Isolation Material	Al_2O_3		
F_{MOUNT}	Mounting Force per Clamp	20 to 50	N	
Weight	Typ.	22	g	
Creepage	Terminal to Heatsink	11.5	mm	
	Terminal to Terminal	6.3	mm	
Clearance	Terminal to Heatsink	10.0	mm	
	Terminal to Terminal	5.0	mm	

Package Marking and Ordering Information

Device	Device Marking	Package	Packing Type	Quantity / Tray
FPF1C2P5MF07AM	FPF1C2P5MF07AM	F1	Tray	22

Electrical Characteristics $T_C = 25^\circ\text{C}$ unless otherwise noted.

Symbol	Parameter	Conditions	Min.	Typ.	Max.	Units
Rectifier Diode						
V_F	Diode Forward Voltage	$I_F = 30\text{ A}$	-	-	1.9	V
		$I_F = 30\text{ A}$ @ $T_C = 125^\circ\text{C}$	-	1.45	-	V
I_R	Reverse Leakage Current	$V_R = 620\text{ V}$	-	-	25	μA
$R_{\theta\text{JC}}$	Thermal Resistance of Junction to Case	per Diode	-	-	1.62	$^\circ\text{C/W}$
High-side IGBT						
Off Characteristics						
BV_{CES}	Collector-Emitter Breakdown Voltage	$V_{\text{GE}} = 0\text{ V}, I_C = 1\text{ mA}$	620	-	-	V
I_{CES}	Collector Cut-off Current	$V_{\text{CE}} = V_{\text{CES}}, V_{\text{GE}} = 0\text{ V}$	-	-	25	μA
I_{GES}	Gate-Emitter Leakage Current	$V_{\text{GE}} = V_{\text{GES}}, V_{\text{CS}} = 0\text{ V}$	-	-	2.5	μA
On Characteristics						
$V_{\text{GE(th)}}$	Gate-Emitter Threshold Voltage	$V_{\text{GE}} = V_{\text{CE}}, I_C = 30\text{ mA}$	4	5.7	7	V
$V_{\text{CE(sat)}}$	Collector-Emitter Saturation Voltage	$I_C = 30\text{ A}, V_{\text{GE}} = 15\text{ V}$	-	1.1	1.6	V
		$I_C = 30\text{ A}, V_{\text{GE}} = 15\text{ V}$ @ $T_C = 125^\circ\text{C}$	-	1.0	-	V
		$I_C = 60\text{ A}, V_{\text{GE}} = 15\text{ V}$	-	1.4	-	V
Switching Characteristics						
Q_g	Total Gate Charge	$V_{\text{DS}} = 380\text{ V}, V_{\text{GS}} = 0\text{V} \dots +15\text{ V}, I_D = 30\text{ A}$	-	214	-	nC
$R_{\theta\text{JC}}$	Thermal Resistance of Junction to Case	per IGBT	-	-	0.54	$^\circ\text{C/W}$

* Note : High-side IGBT is optimized for line frequency switching such as 50/60 Hz.

High-Side FWD						
V_{FM}	Diode Forward Voltage	$I_F = 15\text{ A}, V_{\text{GS}} = 0\text{ V}$	-	1.75	2.25	V
t_{rr}	Reverse Recovery Time	$I_F = 15\text{ A}$ $di_F/dt = 1650\text{ A}/\mu\text{s}$	-	30	-	ns
I_{rr}	Reverse Recovery Current		-	27	-	A
Q_{rr}	Reverse Recovery Charge		-	405	-	nC
t_{rr}	Reverse Recovery Time	$I_F = 15\text{ A}$ $di_F/dt = 1500\text{ A}/\mu\text{s}$ @ $T_C = 125^\circ\text{C}$	-	43	-	ns
I_{rr}	Reverse Recovery Current		-	38	-	A
Q_{rr}	Reverse Recovery Charge		-	814	-	nC
$R_{\theta\text{JC}}$	Thermal Resistance of Junction to Case	per Diode	-	-	1.61	$^\circ\text{C/W}$

Electrical Characteristics $T_C = 25^\circ\text{C}$ unless otherwise noted. (Continued)

Symbol	Parameter	Conditions	Min.	Typ.	Max.	Units
Low-Side MOSFET						
Off Characteristics						
BV_{DSS}	Drain-Source Breakdown Voltage	$V_{GS} = 0\text{ V}, I_D = 1\text{ mA}$	620	-	-	V
I_{DSS}	Zero Gate Voltage Drain Current	$V_{DS} = 620\text{ V}, V_{GS} = 0\text{ V}$	-	-	25	μA
I_{GSS}	Gate-Body Leakage Current, Forward	$V_{GS} = 20\text{ V}, V_{DS} = 0\text{ V}$			2.5	μA
On Characteristics						
$V_{GS(th)}$	Gate-Source Threshold Voltage	$V_{GS} = V_{DS}, I_D = 250\text{ mA}$	2.7	3.8	5.3	V
$R_{DS(on)}$	Static Drain-Source On-Resistance	$I_D = 27\text{ A}, V_{GS} = 10\text{ V}$	-	-	90	$\text{m}\Omega$
		$I_D = 27\text{ A}, V_{GS} = 10\text{ V} @ T_C = 125^\circ\text{C}$	-	135	-	$\text{m}\Omega$
		$I_D = 47\text{ A}, V_{GS} = 10\text{ V}$	-	76	-	$\text{m}\Omega$
V_{SD}	Source-Drain Diode Forward Voltage	$I_{SD} = 27\text{ A}, V_{GS} = 0\text{ V}$	-	-	1.5	V
		$I_{SD} = 47\text{ A}, V_{GS} = 0\text{ V}$	-	1.3	-	V
Switching Characteristics						
$t_{d(on)}$	Turn-On Delay Time	$V_{CC} = 380\text{ V}$	-	57	-	ns
t_r	Rise Time	$I_D = 27\text{ A}$	-	14	-	ns
$t_{d(off)}$	Turn-Off Delay Time	$V_{GS} = 10\text{ V}$	-	240	-	ns
t_f	Fall Time	$R_G = 10\ \Omega$	-	20	-	ns
E_{ON}	Turn-On Switching Loss per Pulse	Inductive Load	-	440	-	μJ
E_{OFF}	Turn-Off Switching Loss per Pulse	$T_C = 25^\circ\text{C}$	-	113	-	μJ
$t_{d(on)}$	Turn-On Delay Time	$V_{CC} = 380\text{ V}$	-	53	-	ns
t_r	Rise Time	$I_D = 27\text{ A}$	-	16	-	ns
$t_{d(off)}$	Turn-Off Delay Time	$V_{GS} = 10\text{ V}$	-	257	-	ns
t_f	Fall Time	$R_G = 10\ \Omega$	-	20	-	ns
E_{ON}	Turn-On Switching Loss per Pulse	Inductive Load	-	719	-	μJ
E_{OFF}	Turn-Off Switching Loss per Pulse	$T_C = 125^\circ\text{C}$	-	124	-	μJ
Q_g	Total Gate Charge	$V_{DS} = 380\text{ V}, V_{GS} = 0\text{V} \dots +10\text{ V}, I_D = 27\text{ A}$	-	155	-	nC
$R_{\theta JC}$	Thermal Resistance of Junction to Case	per Chip	-	-	0.5	$^\circ\text{C}/\text{W}$

Typical Performance Characteristic

Fig 1. Typical Output Characteristics - IGBT

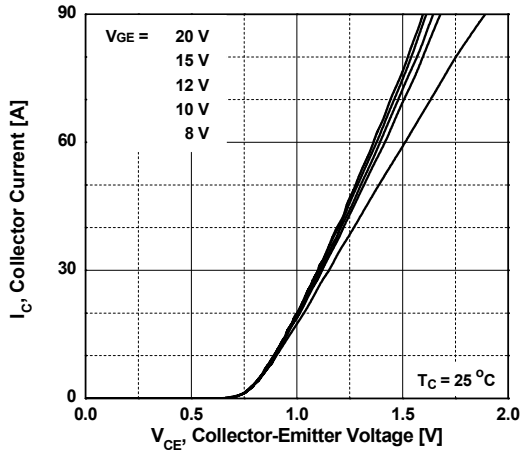

Fig 2. Typical Output Characteristics - IGBT

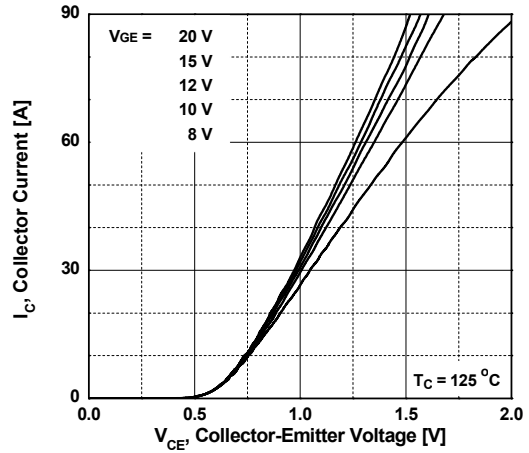

Fig 3. Typical Saturation Voltage Characteristics - IGBT

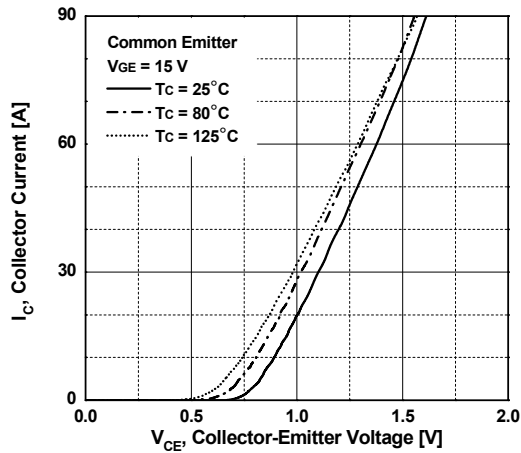

Fig 4. Transient Thermal Response Curve - IGBT

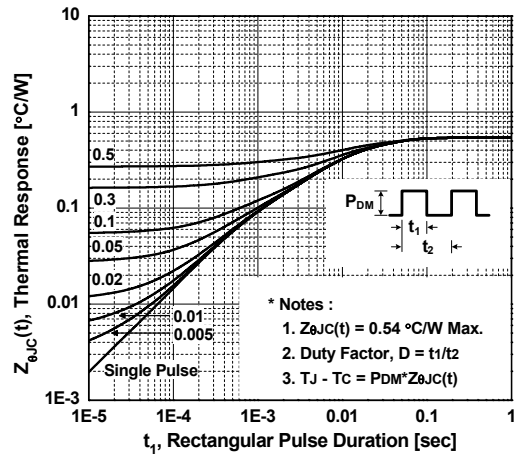

Fig 5. Typical Forward Voltage Drop vs. Forward Current - High-Side FWD

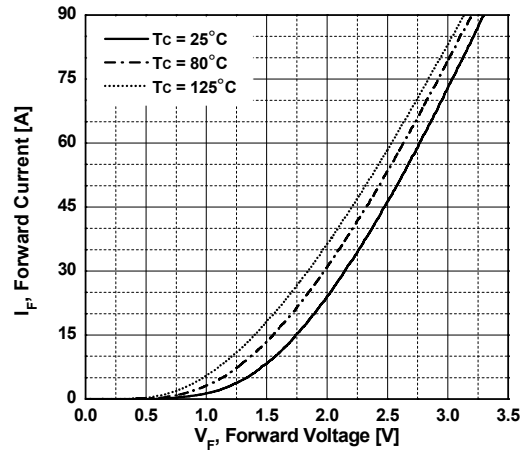
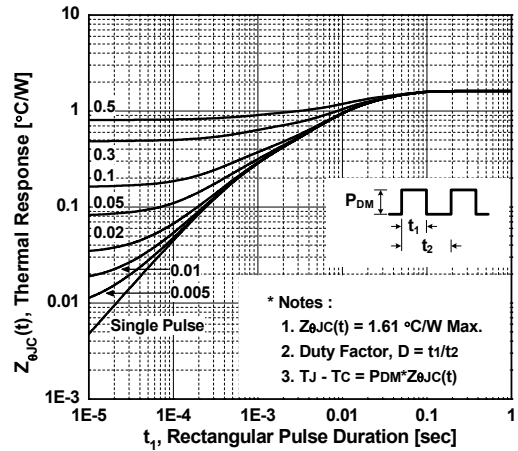

Fig 6. Transient Thermal Response Curve - High-Side FWD



Typical Performance Characteristic (Continued)

Fig 7. On-Region Characteristics - MOSFET

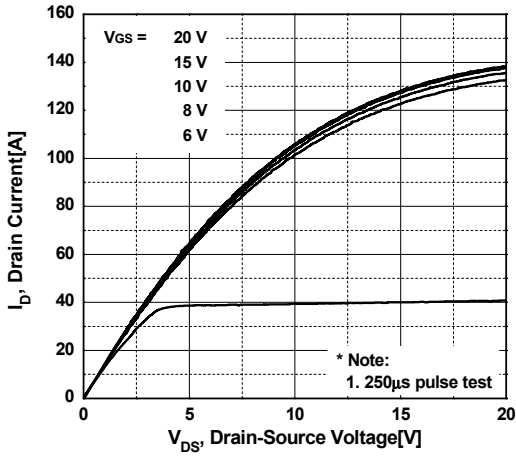

Fig 8. On-Resistance Variation vs. Drain Current and Gate Voltage - MOSFET

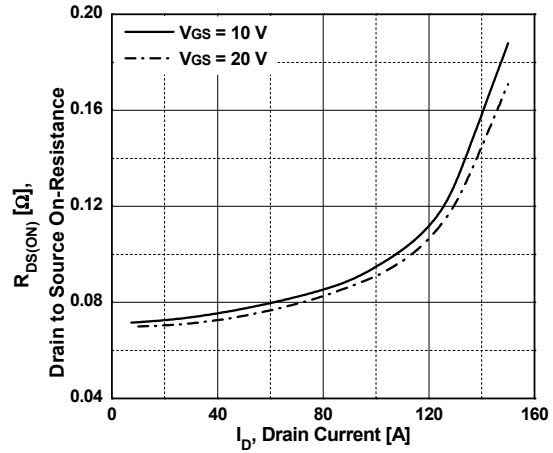

Fig 9. On-Resistance Variation vs. Temperature - MOSFET

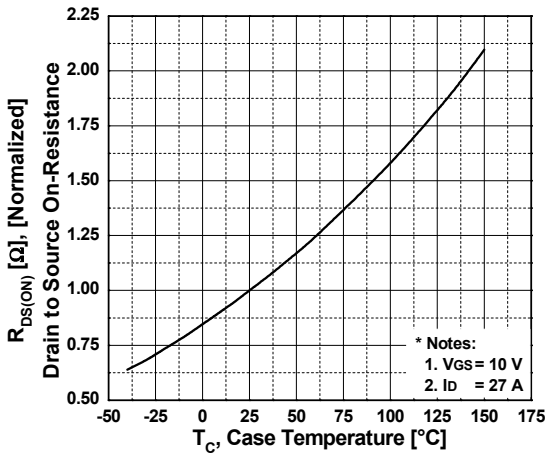

Fig 10. Body Diode Forward Voltage Variation vs. Source Current and Temperature - MOSFET

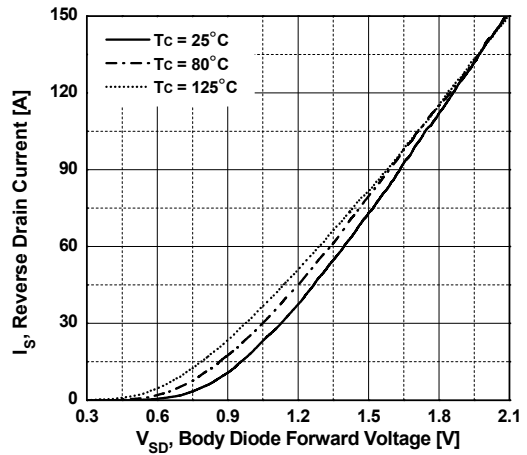

Fig 11. Turn-Off Loss vs. Gate Resistor Values - MOSFET

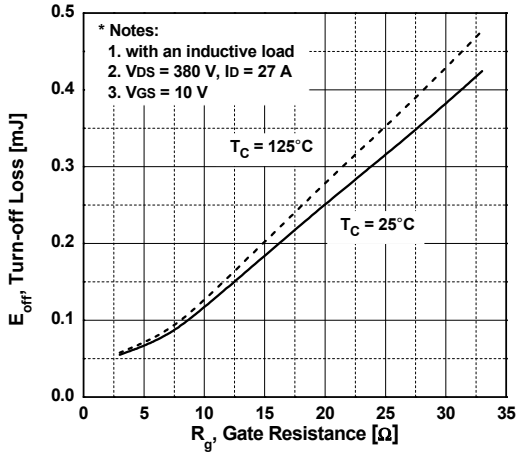
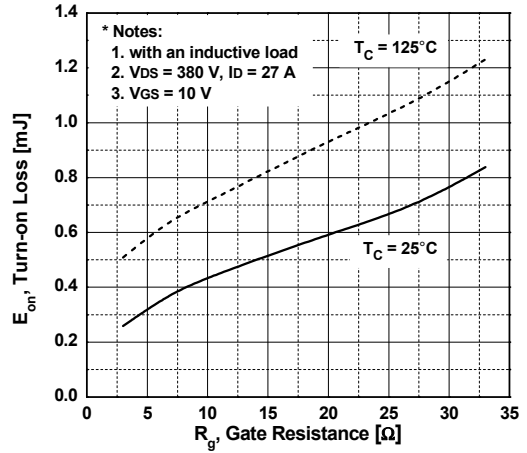

Fig 12. Turn-On Loss vs. Gate Resistor Values - MOSFET



Typical Performance Characteristic (Continued)

Fig 13. Turn-Off Loss vs. Drain Current - MOSFET

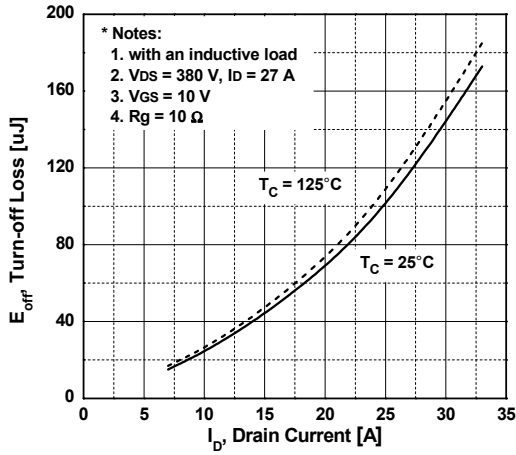

Fig 14. Turn-On Loss vs. Drain Current - MOSFET

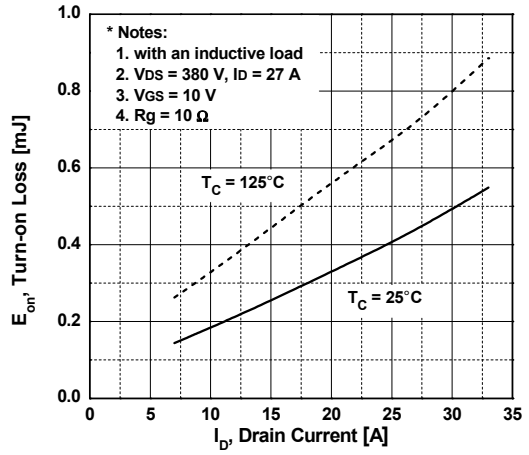

Fig 15. Transient Thermal Response Curve - MOSFET

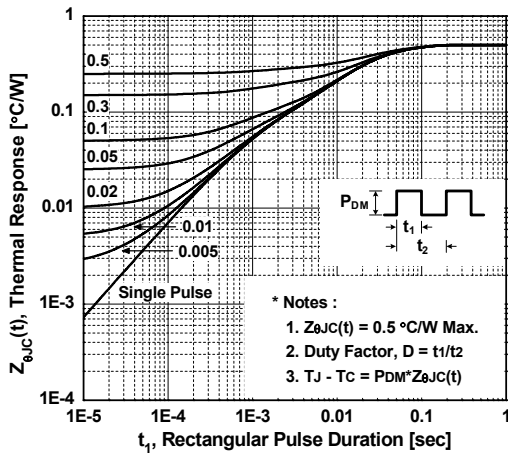

Fig 16. Typical Forward Voltage Drop vs. Forward Current - Rectifier Diode

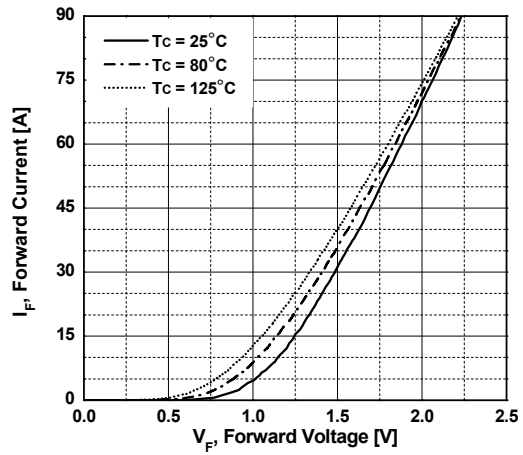
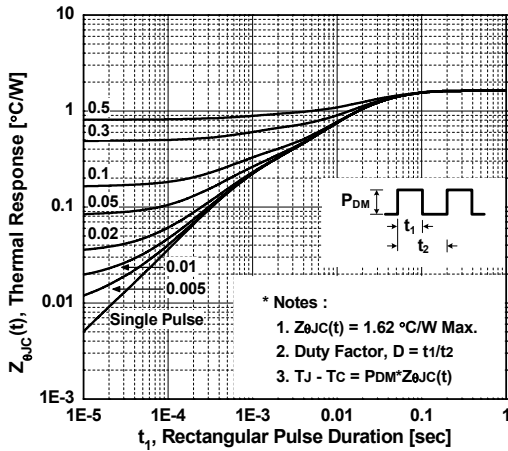
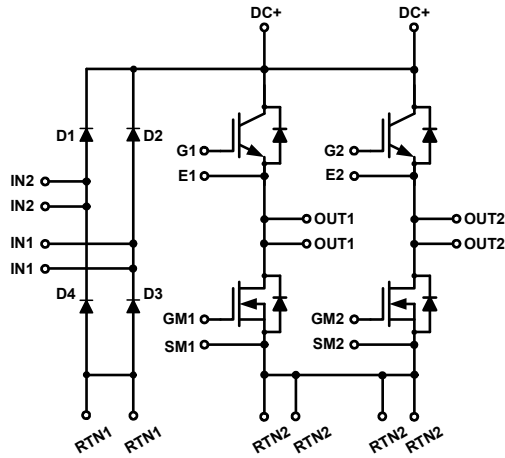

Fig 17. Transient Thermal Response Curve - Rectifier Diode



Internal Circuit Diagram



Package Outlines [mm]

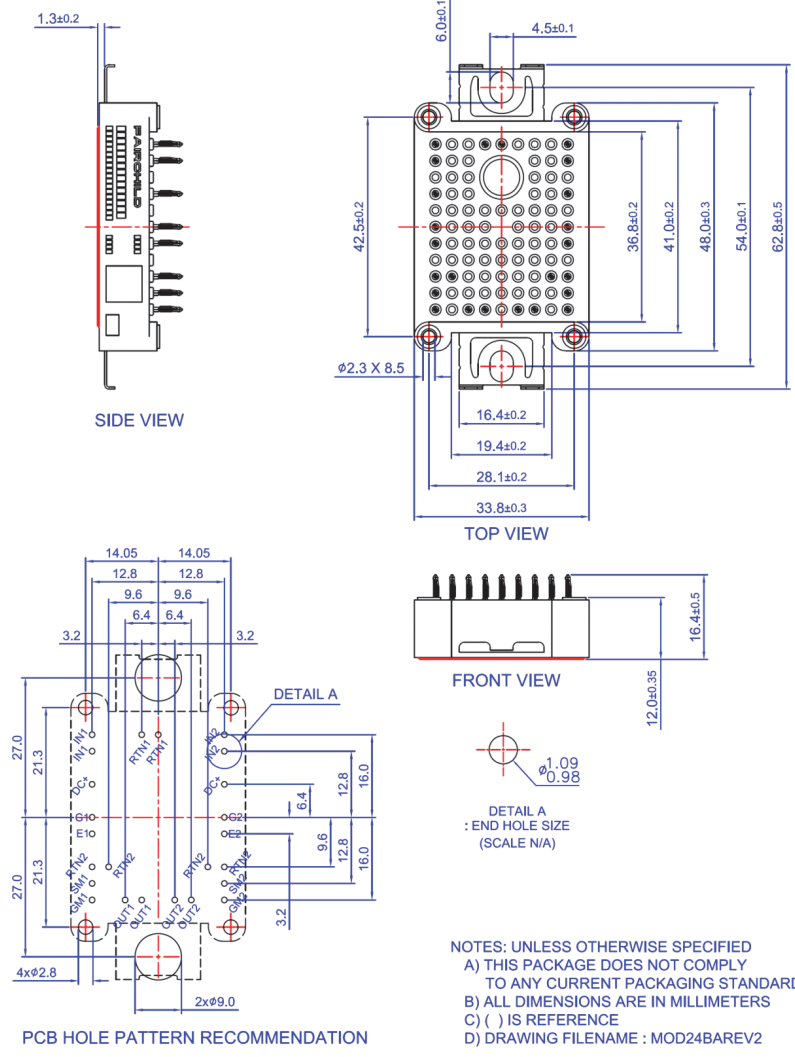

- PIN-GRID 3.2mm
 - TOLERANCE OF PCB HOLE PATTERN ± 0.1





NOTES: UNLESS OTHERWISE SPECIFIED
 A) THIS PACKAGE DOES NOT COMPLY TO ANY CURRENT PACKAGING STANDARD
 B) ALL DIMENSIONS ARE IN MILLIMETERS
 C) () IS REFERENCE
 D) DRAWING FILENAME : MOD24BAREV2





TRADEMARKS

The following includes registered and unregistered trademarks and service marks, owned by Fairchild Semiconductor and/or its global subsidiaries, and is not intended to be an exhaustive list of all such trademarks.

- | | | | |
|---|--|---|---|
| AccuPower™ | F-PFS™ |  | Sync-Lock™ |
| AX-CAP®* | FRFET® | PowerTrench® |  SYSTEM GENERAL® |
| BitSiC™ | Global Power Resource™ | PowerXS™ | TinyBoost® |
| Build it Now™ | GreenBridge™ | Programmable Active Droop™ | TinyBuck® |
| CorePLUS™ | Green FPS™ | QFET® | TinyCalc™ |
| CorePOWER™ | Green FPS™ e-Series™ | QS™ | TinyLogic® |
| CROSSVOLT™ | Gmax™ | Quiet Series™ | TINYOPTO™ |
| CTL™ | GTO™ | RapidConfigure™ | TinyPower™ |
| Current Transfer Logic™ | IntelliMAX™ |  Saving our world, 1mW/W/kW at a time™ | TinyPWM™ |
| DEUXPEED® | ISOPLANAR™ | SignalWise™ | TinyWire™ |
| Dual Cool™ | Making Small Speakers Sound Louder and Better™ | SmartMax™ | TranSiC™ |
| EcoSPARK® | MegaBuck™ | SMART START™ | TriFault Detect™ |
| EfficientMax™ | MICROCOUPLER™ | Solutions for Your Success™ | TRUECURRENT®* |
| ESBC™ | MicroFET™ | SPM® | μSerDes™ |
|  | MicroPak™ | STEALTH™ |  SerDes™ |
| Fairchild® | MicroPak2™ | SuperFET® | UHC® |
| Fairchild Semiconductor® | MillerDrive™ | SuperSOT™-3 | Ultra FRFET™ |
| FACT Quiet Series™ | MotionMax™ | SuperSOT™-6 | UniFET™ |
| FACT® | mWSaver® | SuperSOT™-8 | VCX™ |
| FAST® | OptoHit™ | SupreMOS® | VisualMax™ |
| FastvCore™ | OPTOLOGIC® | SyncFET™ | VoltagePlus™ |
| FETBench™ | OPTOPLANAR® | | XS™ |
| FPS™ | | | |

* Trademarks of System General Corporation, used under license by Fairchild Semiconductor.

DISCLAIMER

FAIRCHILD SEMICONDUCTOR RESERVES THE RIGHT TO MAKE CHANGES WITHOUT FURTHER NOTICE TO ANY PRODUCTS HEREIN TO IMPROVE RELIABILITY, FUNCTION, OR DESIGN. FAIRCHILD DOES NOT ASSUME ANY LIABILITY ARISING OUT OF THE APPLICATION OR USE OF ANY PRODUCT OR CIRCUIT DESCRIBED HEREIN; NEITHER DOES IT CONVEY ANY LICENSE UNDER ITS PATENT RIGHTS, NOR THE RIGHTS OF OTHERS. THESE SPECIFICATIONS DO NOT EXPAND THE TERMS OF FAIRCHILD'S WORLDWIDE TERMS AND CONDITIONS, SPECIFICALLY THE WARRANTY THEREIN, WHICH COVERS THESE PRODUCTS.

LIFE SUPPORT POLICY

FAIRCHILD'S PRODUCTS ARE NOT AUTHORIZED FOR USE AS CRITICAL COMPONENTS IN LIFE SUPPORT DEVICES OR SYSTEMS WITHOUT THE EXPRESS WRITTEN APPROVAL OF FAIRCHILD SEMICONDUCTOR CORPORATION.

As used herein:

- Life support devices or systems are devices or systems which, (a) are intended for surgical implant into the body or (b) support or sustain life, and (c) whose failure to perform when properly used in accordance with instructions for use provided in the labeling, can be reasonably expected to result in a significant injury of the user.
- A critical component in any component of a life support, device, or system whose failure to perform can be reasonably expected to cause the failure of the life support device or system, or to affect its safety or effectiveness.

ANTI-COUNTERFEITING POLICY

Fairchild Semiconductor Corporation's Anti-Counterfeiting Policy. Fairchild's Anti-Counterfeiting Policy is also stated on our external website, www.fairchildsemi.com, under Sales Support.

Counterfeiting of semiconductor parts is a growing problem in the industry. All manufacturers of semiconductor products are experiencing counterfeiting of their parts. Customers who inadvertently purchase counterfeit parts experience many problems such as loss of brand reputation, substandard performance, failed applications, and increased cost of production and manufacturing delays. Fairchild is taking strong measures to protect ourselves and our customers from the proliferation of counterfeit parts. Fairchild strongly encourages customers to purchase Fairchild parts either directly from Fairchild or from Authorized Fairchild Distributors who are listed by country on our web page cited above. Products customers buy either from Fairchild directly or from Authorized Fairchild Distributors are genuine parts, have full traceability, meet Fairchild's quality standards for handling and storage and provide access to Fairchild's full range of up-to-date technical and product information. Fairchild and our Authorized Distributors will stand behind all warranties and will appropriately address any warranty issues that may arise. Fairchild will not provide any warranty coverage or other assistance for parts bought from Unauthorized Sources. Fairchild is committed to combat this global problem and encourage our customers to do their part in stopping this practice by buying direct or from authorized distributors.

PRODUCT STATUS DEFINITIONS

Definition of Terms

Datasheet Identification	Product Status	Definition
Advance Information	Formative / In Design	Datasheet contains the design specifications for product development. Specifications may change in any manner without notice.
Preliminary	First Production	Datasheet contains preliminary data; supplementary data will be published at a later date. Fairchild Semiconductor reserves the right to make changes at any time without notice to improve design.
No Identification Needed	Full Production	Datasheet contains final specifications. Fairchild Semiconductor reserves the right to make changes at any time without notice to improve the design.
Obsolete	Not In Production	Datasheet contains specifications on a product that is discontinued by Fairchild Semiconductor. The datasheet is for reference information only.

Rev. 166

ON Semiconductor and  are trademarks of Semiconductor Components Industries, LLC dba ON Semiconductor or its subsidiaries in the United States and/or other countries. ON Semiconductor owns the rights to a number of patents, trademarks, copyrights, trade secrets, and other intellectual property. A listing of ON Semiconductor's product/patent coverage may be accessed at www.onsemi.com/site/pdf/Patent-Marking.pdf. ON Semiconductor reserves the right to make changes without further notice to any products herein. ON Semiconductor makes no warranty, representation or guarantee regarding the suitability of its products for any particular purpose, nor does ON Semiconductor assume any liability arising out of the application or use of any product or circuit, and specifically disclaims any and all liability, including without limitation special, consequential or incidental damages. Buyer is responsible for its products and applications using ON Semiconductor products, including compliance with all laws, regulations and safety requirements or standards, regardless of any support or applications information provided by ON Semiconductor. "Typical" parameters which may be provided in ON Semiconductor data sheets and/or specifications can and do vary in different applications and actual performance may vary over time. All operating parameters, including "Typicals" must be validated for each customer application by customer's technical experts. ON Semiconductor does not convey any license under its patent rights nor the rights of others. ON Semiconductor products are not designed, intended, or authorized for use as a critical component in life support systems or any FDA Class 3 medical devices or medical devices with a same or similar classification in a foreign jurisdiction or any devices intended for implantation in the human body. Should Buyer purchase or use ON Semiconductor products for any such unintended or unauthorized application, Buyer shall indemnify and hold ON Semiconductor and its officers, employees, subsidiaries, affiliates, and distributors harmless against all claims, costs, damages, and expenses, and reasonable attorney fees arising out of, directly or indirectly, any claim of personal injury or death associated with such unintended or unauthorized use, even if such claim alleges that ON Semiconductor was negligent regarding the design or manufacture of the part. ON Semiconductor is an Equal Opportunity/Affirmative Action Employer. This literature is subject to all applicable copyright laws and is not for resale in any manner.

PUBLICATION ORDERING INFORMATION

LITERATURE FULFILLMENT:

Literature Distribution Center for ON Semiconductor
19521 E. 32nd Pkwy, Aurora, Colorado 80011 USA
Phone: 303-675-2175 or 800-344-3860 Toll Free USA/Canada
Fax: 303-675-2176 or 800-344-3867 Toll Free USA/Canada
Email: orderlit@onsemi.com

N. American Technical Support: 800-282-9855 Toll Free
USA/Canada
Europe, Middle East and Africa Technical Support:
Phone: 421 33 790 2910
Japan Customer Focus Center
Phone: 81-3-5817-1050

ON Semiconductor Website: www.onsemi.com
Order Literature: <http://www.onsemi.com/orderlit>
For additional information, please contact your local
Sales Representative