

## Ambient Light Sensor

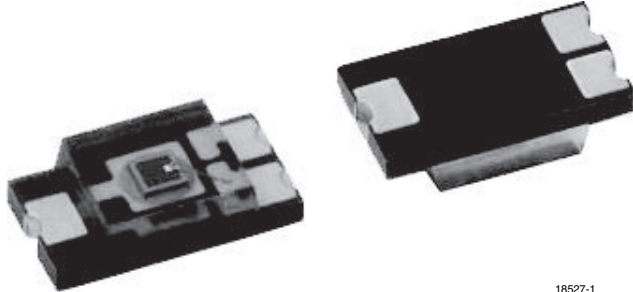

18527-1

### DESCRIPTION

TEMD6010FX01 ambient light sensor is a PIN photodiode with high speed and high photo sensitivity in a clear, surface mount plastic package. The detector chip has 0.27 mm<sup>2</sup> sensitive area. It is sensitive to visible light much like the human eye and has peak sensitivity at 540 nm.

### FEATURES

- Package type: surface mount
- Package form: 1206
- Dimensions (L x W x H in mm): 4 x 2 x 1.05
- Radiant sensitive area (in mm<sup>2</sup>): 0.27
- AEC-Q101 qualified
- High photo sensitivity
- Adapted to human eye responsivity
- Supression filter for near infrared radiation
- Angle of half sensitivity:  $\phi = \pm 60^\circ$
- Floor life: 168 h, MSL 3, acc. J-STD-020
- Lead (Pb)-free reflow soldering
- Material categorization: For definitions of compliance please see [www.vishay.com/doc?99912](http://www.vishay.com/doc?99912)

 AUTOMOTIVE  
GRADE

**RoHS**  
COMPLIANT  
**GREEN**  
(5-2009)

### APPLICATIONS

- Automotive sensors
- Ambient light sensors
- Backlight dimming
- Mobil phones
- Notebooks
- Computers

### PRODUCT SUMMARY

COMPONENT	$I_{ra}$ ( $\mu$ A)	$\phi$ (deg)	$\lambda_{0.5}$ (nm)
TEMD6010FX01	0.04	$\pm 60$	430 to 610

#### Note

- Test conditions see table "Basic Characteristics"

### ORDERING INFORMATION

ORDERING CODE	PACKAGING	REMARKS	PACKAGE FORM
TEMD6010FX01	Tape and reel	MOQ: 3000 pcs, 3000 pcs/reel	1206

#### Note

- MOQ: minimum order quantity

### ABSOLUTE MAXIMUM RATINGS ( $T_{amb} = 25^\circ\text{C}$ , unless otherwise specified)

PARAMETER	TEST CONDITION	SYMBOL	VALUE	UNIT
Reverse voltage		$V_R$	16	V
Power dissipation		$P_V$	100	mW
Junction temperature		$T_j$	100	$^\circ\text{C}$
Operating temperature range		$T_{amb}$	- 40 to + 100	$^\circ\text{C}$
Storage temperature range		$T_{stg}$	- 40 to + 100	$^\circ\text{C}$
Soldering temperature	Acc. reflow solder profile fig. 7	$T_{sd}$	260	$^\circ\text{C}$
Thermal resistance junction/ambient	Soldered on PCB with pad dimensions: 4 mm x 4 mm	$R_{thJA}$	450	K/W

BASIC CHARACTERISTICS ( $T_{amb} = 25\text{ }^{\circ}\text{C}$ , unless otherwise specified)						
PARAMETER	TEST CONDITION	SYMBOL	MIN.	TYP.	MAX.	UNIT
Breakdown voltage	$I_R = 100\text{ }\mu\text{A}$ , $E = 0\text{ lx}$	$V_{(BR)}$	16			V
Reverse dark current	$V_{CE} = 10\text{ V}$ , $E = 0\text{ lx}$	$I_{ro}$		0.1	5	nA
Diode capacitance	$V_R = 0\text{ V}$ , $f = 1\text{ MHz}$ , $E = 0\text{ lx}$	$C_D$		60		pF
	$V_R = 5\text{ V}$ , $f = 1\text{ MHz}$ , $E = 0\text{ lx}$	$C_D$		24		pF
Reverse light current	$E_e = 1\text{ mW/cm}^2$ , $\lambda = 550\text{ nm}$ , $V_R = 5\text{ V}$	$I_{ra}$		1		$\mu\text{A}$
	$E_V = 100\text{ lx}$ , CIE illuminant A, $V_R = 5\text{ V}$	$I_{ra}$	0.03	0.04	0.09	$\mu\text{A}$
Temperature coefficient of $I_{ra}$	$E_V = 100\text{ lx}$ , CIE illuminant A, $V_R = 5\text{ V}$	$TK_{I_{ra}}$		0.2		%/K
Angle of half sensitivity		$\varphi$		$\pm 60$		deg
Wavelength of peak sensitivity		$\lambda_p$		540		nm
Range of spectral bandwidth		$\lambda_{0.5}$		430 to 610		nm

**BASIC CHARACTERISTICS** ( $T_{amb} = 25\text{ }^{\circ}\text{C}$ , unless otherwise specified)

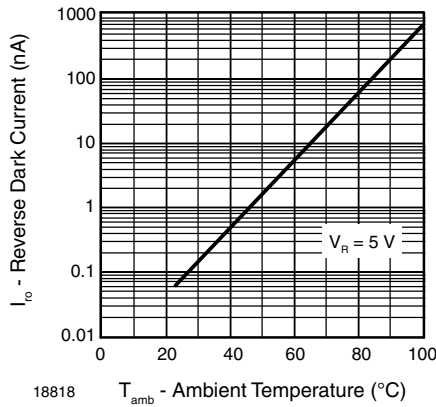

Fig. 1 - Reverse Dark Current vs. Ambient Temperature

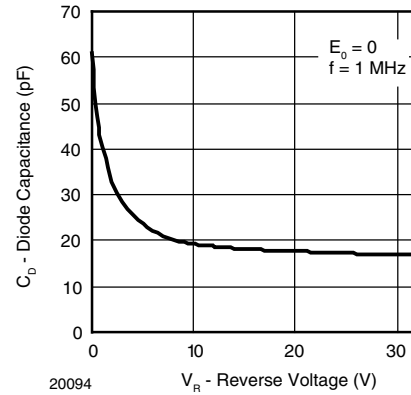

Fig. 3 - Diode Capacitance vs. Reverse Voltage

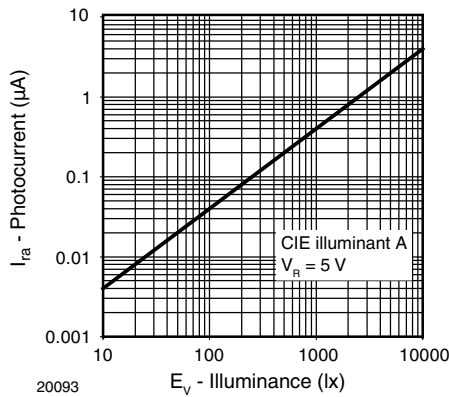

Fig. 2 - Reverse Light Current vs. Illuminance

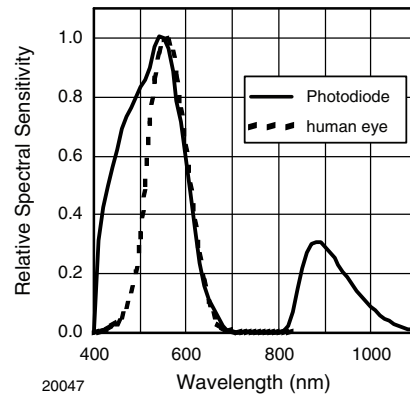

Fig. 4 - Relative Spectral Sensitivity vs. Wavelength

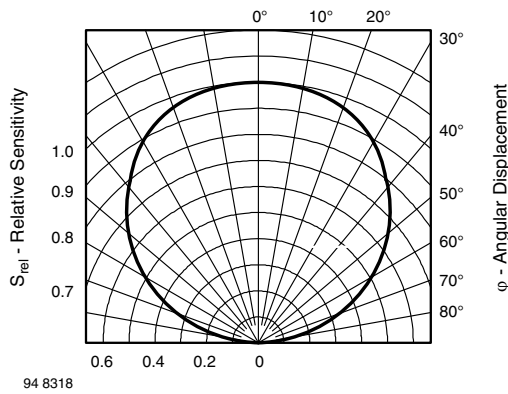

Fig. 1 - Relative Radiant Sensitivity vs. Angular Displacement

**REFLOW SOLDER PROFILE**

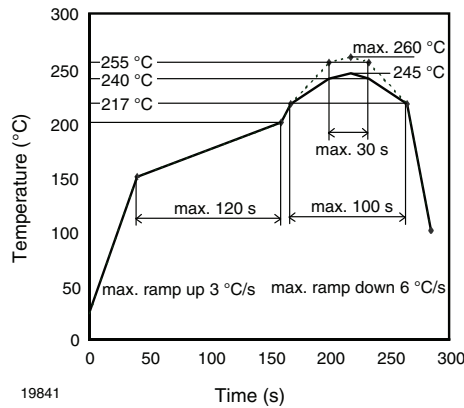
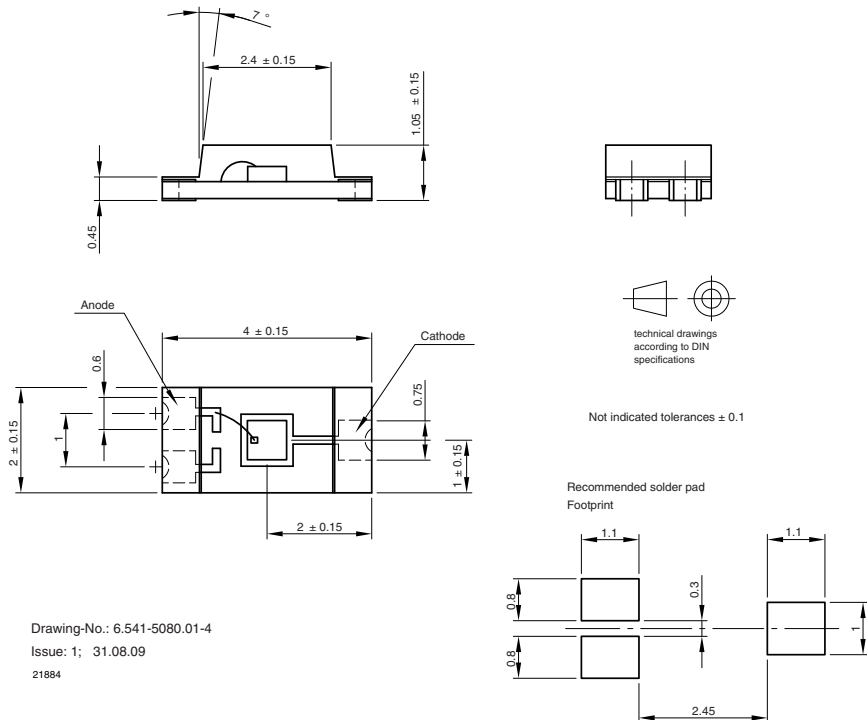

Fig. 5 - Lead (Pb)-free Reflow Solder Profile acc. J-STD-020D

**PACKAGE DIMENSIONS** in millimeters



**DRYPACK**

Devices are packed in moisture barrier bags (MBB) to prevent the products from moisture absorption during transportation and storage. Each bag contains a desiccant.

**FLOOR LIFE**

Time between soldering and removing from MBB must not exceed the time indicated in J-STD-020:  
 Moisture sensitivity: level 3  
 Floor life: 168 h  
 Conditions:  $T_{amb} < 30\text{ }^{\circ}\text{C}$ ,  $RH < 60\%$

**DRYING**

In case of moisture absorption devices should be baked before soldering. Conditions see J-STD-020 or label. Devices taped on reel dry using recommended conditions:  
 192 h at  $40\text{ }^{\circ}\text{C}$  (+ 5 °C),  $RH < 5\%$   
 or  
 96 h at  $60\text{ }^{\circ}\text{C}$  (+ 5 °C),  $RH < 5\%$ .

**BLISTER TAPE DIMENSIONS** in millimeters

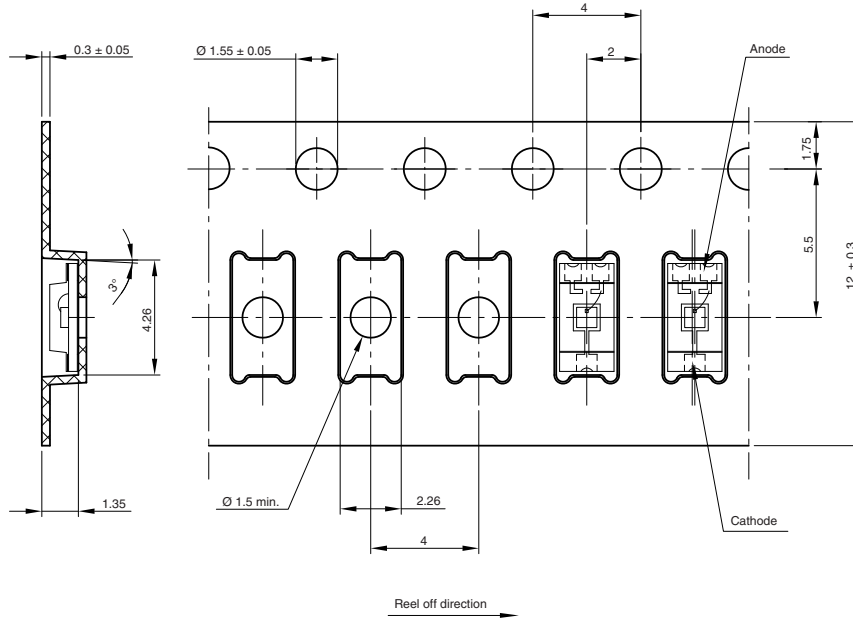

Drawing-No.: 9.700-5329.02-4  
 Issue: 2; 31.08.09  
 20877

Not indicated tolerances  $\pm 0.1$

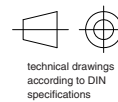

**REEL DIMENSIONS** in millimeters

Volume: 3000 pcs/reel

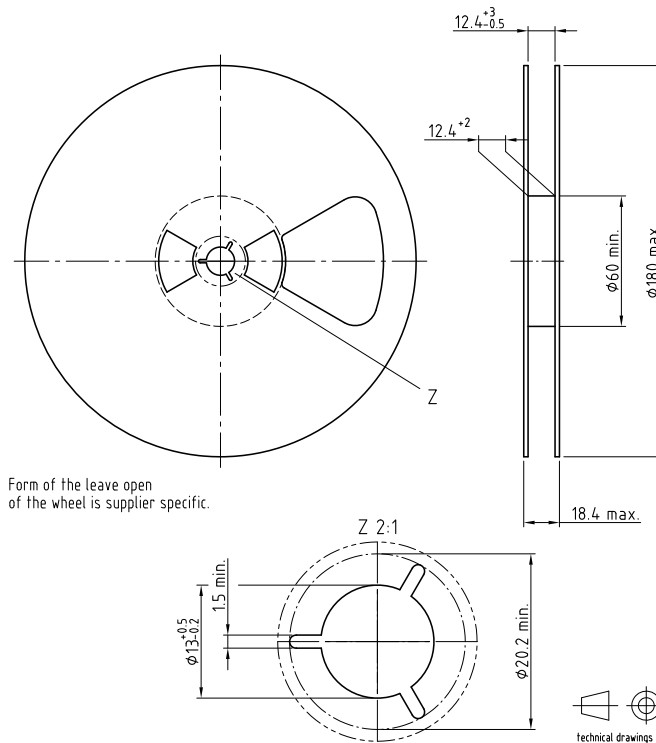

Drawing-No.: 9.800-5097.01-4  
 Issue: 1; 05.05.08  
 20874





## **Disclaimer**

ALL PRODUCT, PRODUCT SPECIFICATIONS AND DATA ARE SUBJECT TO CHANGE WITHOUT NOTICE TO IMPROVE RELIABILITY, FUNCTION OR DESIGN OR OTHERWISE.

Vishay Intertechnology, Inc., its affiliates, agents, and employees, and all persons acting on its or their behalf (collectively, "Vishay"), disclaim any and all liability for any errors, inaccuracies or incompleteness contained in any datasheet or in any other disclosure relating to any product.

Vishay makes no warranty, representation or guarantee regarding the suitability of the products for any particular purpose or the continuing production of any product. To the maximum extent permitted by applicable law, Vishay disclaims (i) any and all liability arising out of the application or use of any product, (ii) any and all liability, including without limitation special, consequential or incidental damages, and (iii) any and all implied warranties, including warranties of fitness for particular purpose, non-infringement and merchantability.

Statements regarding the suitability of products for certain types of applications are based on Vishay's knowledge of typical requirements that are often placed on Vishay products in generic applications. Such statements are not binding statements about the suitability of products for a particular application. It is the customer's responsibility to validate that a particular product with the properties described in the product specification is suitable for use in a particular application. Parameters provided in datasheets and / or specifications may vary in different applications and performance may vary over time. All operating parameters, including typical parameters, must be validated for each customer application by the customer's technical experts. Product specifications do not expand or otherwise modify Vishay's terms and conditions of purchase, including but not limited to the warranty expressed therein.

Except as expressly indicated in writing, Vishay products are not designed for use in medical, life-saving, or life-sustaining applications or for any other application in which the failure of the Vishay product could result in personal injury or death. Customers using or selling Vishay products not expressly indicated for use in such applications do so at their own risk. Please contact authorized Vishay personnel to obtain written terms and conditions regarding products designed for such applications.

No license, express or implied, by estoppel or otherwise, to any intellectual property rights is granted by this document or by any conduct of Vishay. Product names and markings noted herein may be trademarks of their respective owners.