

HWB Series HWB030S-12 Ultra-low Noise Power Supply (30 W, Single-Output)

General Description

The HWB series employs proprietary LLC type resonant-mode circuits. These low price, ultra-low noise (ripple voltage, conducted emissions, and noise electric field strength) power supplies have a built-in propriety resonant-mode hybrid IC and transformer.

Features and Benefits

- Ripple noise: less than 5 mV_{P-P}
- Conduction noise: lower than Class-B of CISPR by 20 dB
- Radiation noise: Complies with Class-B of CISPR
- Leakage current: 50 μA or less for medical use
- Safety mark for medical use: EN60601-1 3rd edition
- Safety standards: UL1950, CSA950, EN60950, and CE marking
- World-wide input range
- Parallel operation

Sample Test Conditions

Input Voltage, V_{IN}

Min. (V)	Nom. (V)		Max. (V)
85	100	240	264

Load Current, I_{LOAD}

Output Voltage (V)	Min. (A)	Nom. (A)	Max. (A)
12	0	3	3

Model Number Key Table

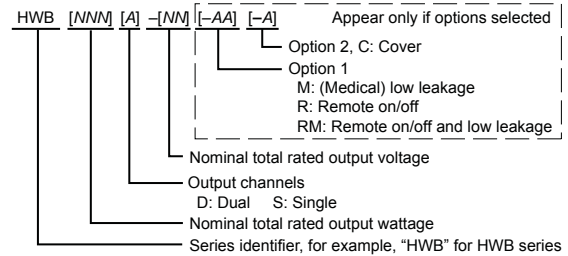

Sample Test Circuit Diagram

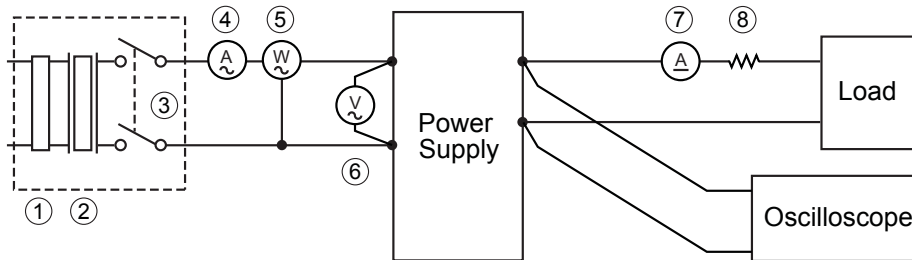

Key	Description	Remarks
-	Measuring instrument	Output voltage is measured with a digital multimeter
1	Variable autotransformer	-
2	Isolation transformer	-
3	Circuit breaker	-
4, 7	Ammeter	-
5	Watt meter	-
6	Volt meter	-
8	Shunt resistor	-

List of Tables

1. Input Characteristics	3	Overvoltage Protection	
Input Current		Reset Time	
Input Power		4. Environment Tests	14
Power Factor		Vibration (Non-Operating)	
Efficiency		Power-On at High Temperature	
Inrush Current		Power-On at Low Temperature	
Leakage Current (Standard Model)		Shock	
Leakage Current (Medical Equipment Model)		5. Noise Tolerance Characteristics	15
Minimum Input Voltage for Voltage Output		AC Line Noise	
Hold-Up Time		Lightning Surge	
2. Output Characteristics	7	Electrostatic Discharge	
Output Setting Voltage		6. Other Characteristics	16
Input/Output Voltage Change Fluctuation		Withstand Voltage (Standard Model)	
Temperature Drift		Leakage Current at Withstand Voltage (Standard Model)	
Warm-Up Drift		Withstand Voltage (Medical Equipment Model)	
Total Regulation		Leakage Current at Withstand Voltage (Medical Equipment Model)	
Ripple Voltage		Insulation Resistance	
Ripple Noise Voltage		7. Output under Dynamic Load	17
Output Voltage Variable Range		Output Voltage at $T_A = -10^\circ\text{C}$	
3. Protection Characteristics	11	Output Voltage at $T_A = 60^\circ\text{C}$	
Overcurrent Protection			

List of Figures

1. Input Current	3	11. Warm-Up Drift	9
2. Power Factor	4	12. Ripple Voltage	9
3. Efficiency	4	13. Ripple Noise Voltage	10
4. Inrush Current	5	14. Overcurrent Protection	11
5. Inrush Current Operation	5	15. Overvoltage Protection	12
6. Leakage Current	6	16. Overvoltage Protection Operation	12
7. Hold-Up Time	6	17. Start-Up Time	13
8. Output Voltage Accuracy	7	18. Conduction Noise 100 V	15
9. Output Voltage Rising	8	19. Conduction Noise 240 V	15
10. Output Voltage Falling	8	20. Dynamic Load	17

Table 1. Input Characteristics
(At $T_A = 25^\circ\text{C}$)

Test Item	Conditions		Test Results			Specification	Remarks
	V_{IN}	I_{LOAD}	$V_{IN} = 100\text{ V}$	$V_{IN} = 240\text{ V}$			
Input Current	Nom	Nom	0.62 A	0.30 A	–	0.8 A	Figure 1
Input Power	Nom	Nom	44.86 W	43.14 W	–	–	–
Power Factor	Nom	Nom	0.722	0.595	–	–	Figure 2
Efficiency	Nom	Nom	80.02%	83.39%	–	77%	Figure 3
Inrush Current	Nom	Nom	13.10 A	34.52 A	–	30 A/ 60 A	Figure 4
Leakage Current (Standard Model)	Nom	Nom	0.051 mA at 60 Hz	0.125 mA at 60 Hz	R = 1.5 k Ω , C = 0.15 μF	0.25 mA	Figure 6
Leakage Current (Medical Equipment Model)	Nom	Nom	0.019 mA at 60 Hz	0.044 mA at 60 Hz	R = 1.5 k Ω , C = 0.15 μF	50 μA	–
Minimum Input Voltage for Voltage Output	–	Min	–	–	On = 38.5 V Off = 14.8 V	–	–
	–	Nom	–	–	On = 40.5 V Off = 28.4 V	–	–
Hold-Up Time	–	Nom	–	–	30 ms at $T_A = 25^\circ\text{C}$	20 ms	Figure 7

Figure 1. Input Current
(By Load Current)

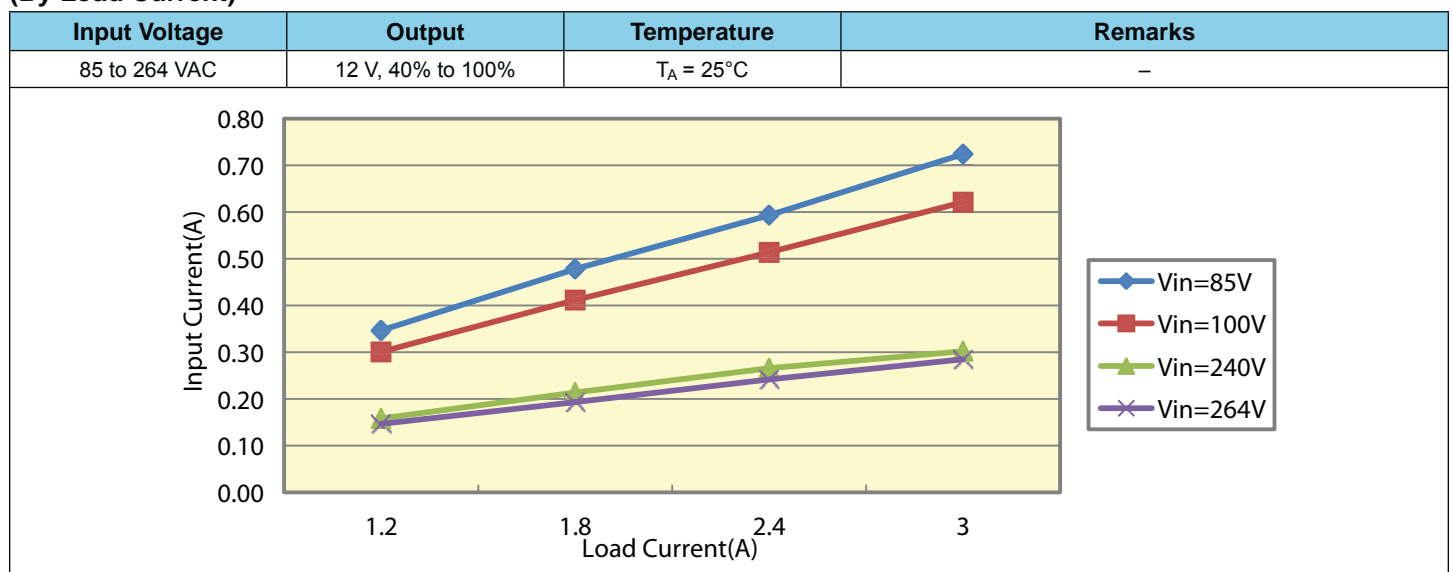

**Figure 2. Power Factor
(By Load Current)**

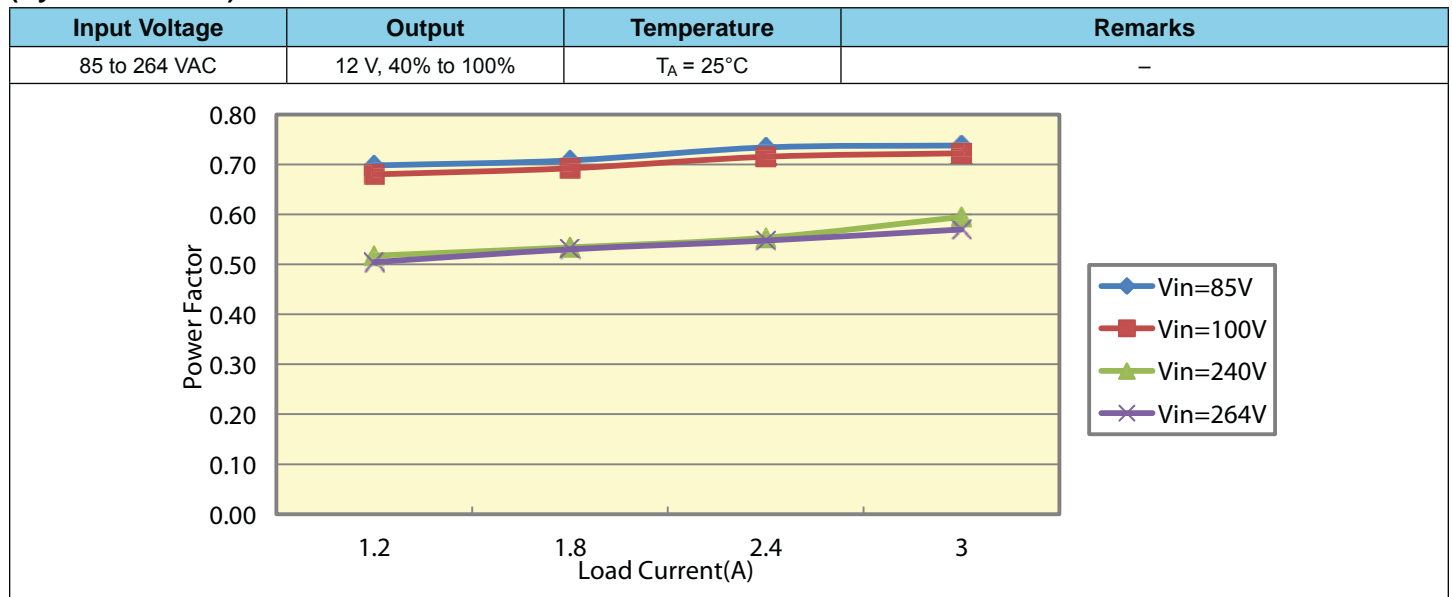

**Figure 3. Efficiency
(By Load Current)**

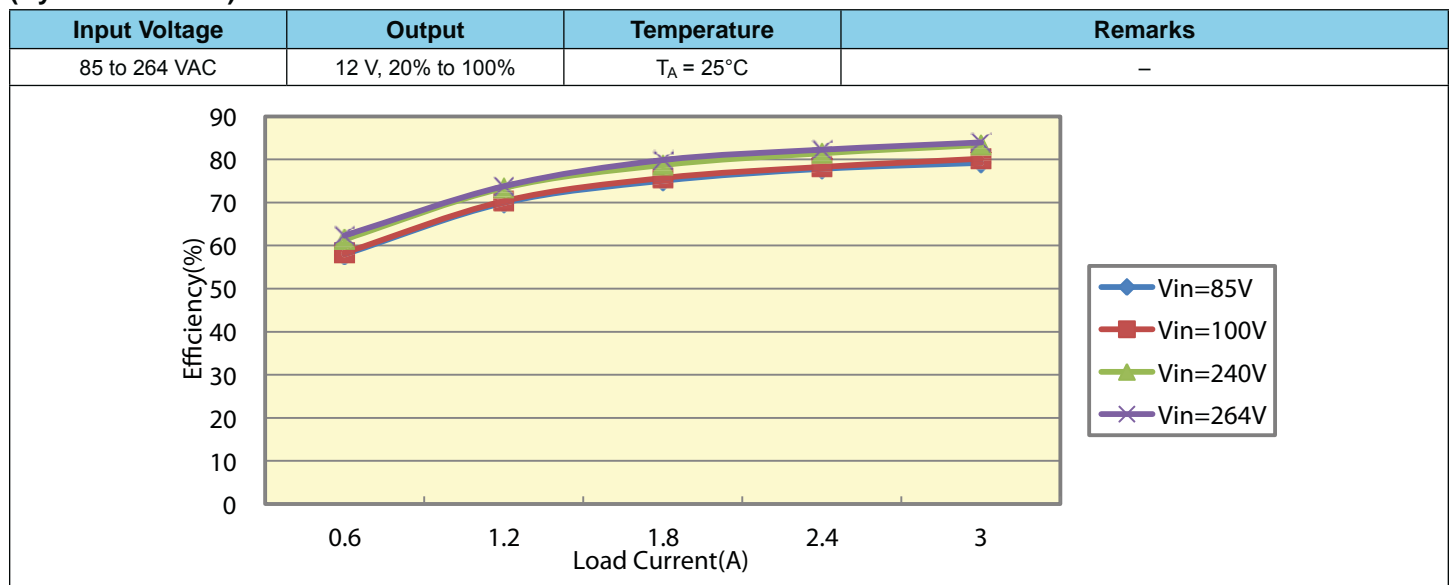

Figure 4. Inrush Current (By Input Voltage)

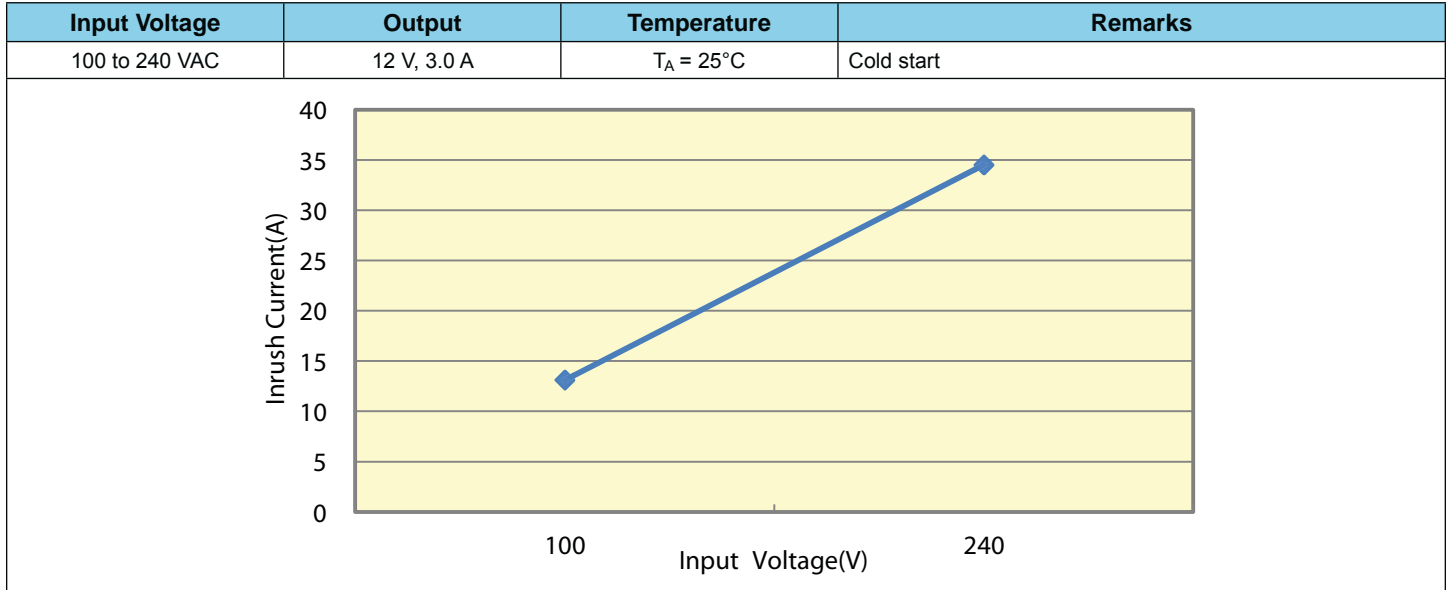

Figure 5. Inrush Current Operation

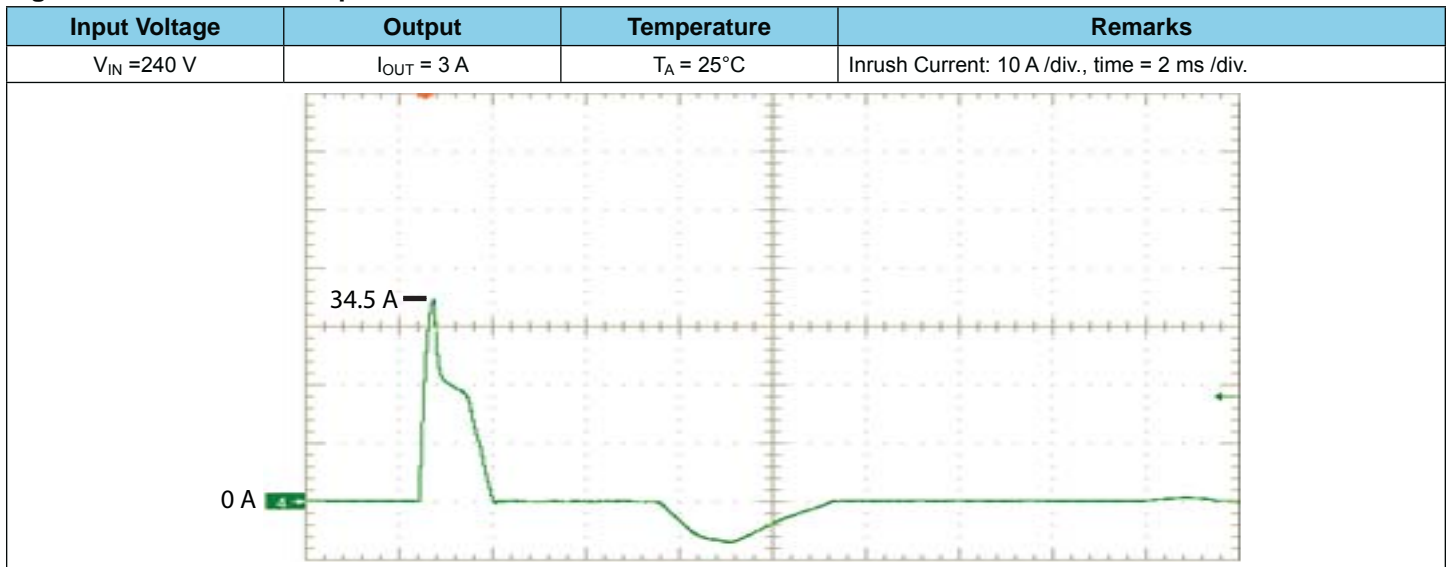

Figure 6. Leakage Current (By Load Current)

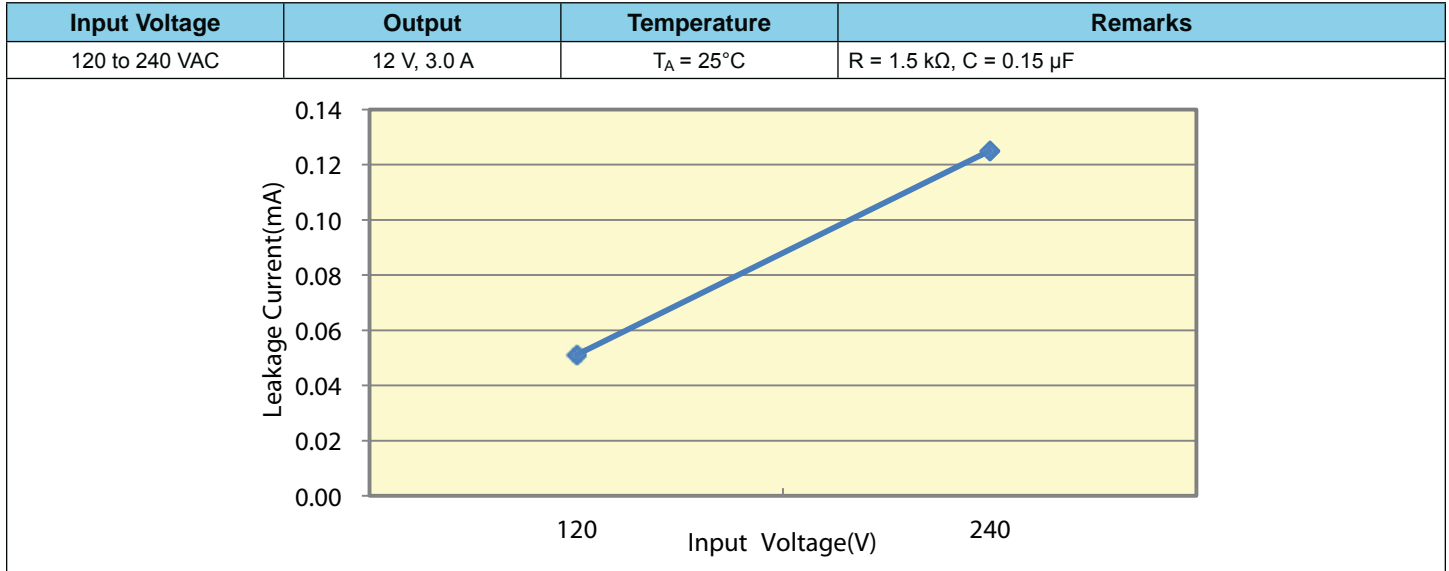

Figure 7. Hold-Up Time (By Load Current)

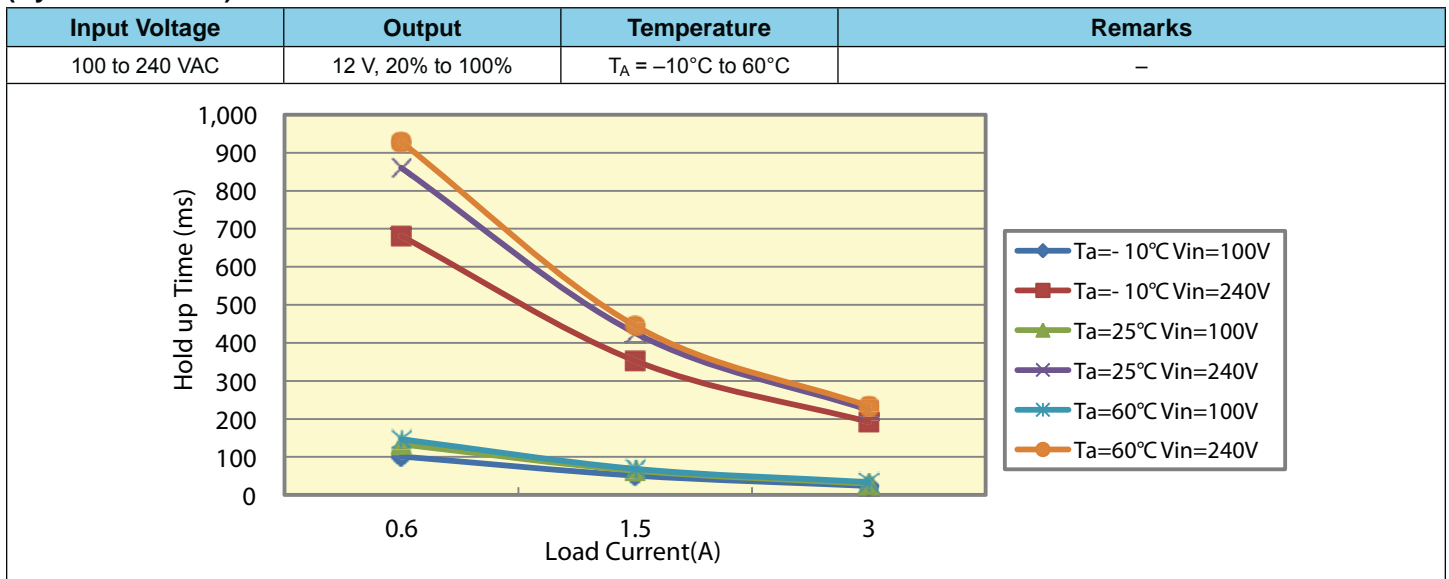

Table 2. Output Characteristics
(At $T_A = 25^\circ\text{C}$)

Test Item	Conditions		Test Results			Specification	Remarks
	V_{IN}	I_{LOAD}	12 V				
Output Setting Voltage	Nom	Nom	-8 mV			-	-
Input/Output Voltage Change Fluctuation	Min	Min	11.991 V			-	Note 1, Figure 8
	Max	Max	12.002 V			-	
Temperature Drift	Nom	Nom	-45 mV to +60 mV			-	Note 1, Figure 8
Warm-Up Drift	Nom	Nom	-45 mV			-	Note 1, Figure 11
Total Regulation	-	-	11.901 V			11.640 V	Note 1
	-	-	12.062 V			12.360 V	
Ripple Voltage	Nom	Nom	2.1 mV at $T_A = 25^\circ\text{C}$			5 mV	Note 2, Figure 12
Ripple Noise Voltage	Nom	Nom	3.8 mV at $T_A = 25^\circ\text{C}$			10 mV	Note 3, Figure 13
Output Voltage Variable Range	Min	Min	10.804 V			11.400 V	-
	Max	Max	14.253 V			13.200 V	-

1. Total Regulation (output regulation) is the sum of: Input/Output Voltage Change Fluctuation, Temperature Drift, and Warm-Up Drift.
2. Used probe = Ripple Voltage 1:1.
3. Used probe = Ripple Noise Voltage 1:1.

Figure 8. Output Voltage Accuracy
(By Load Current)

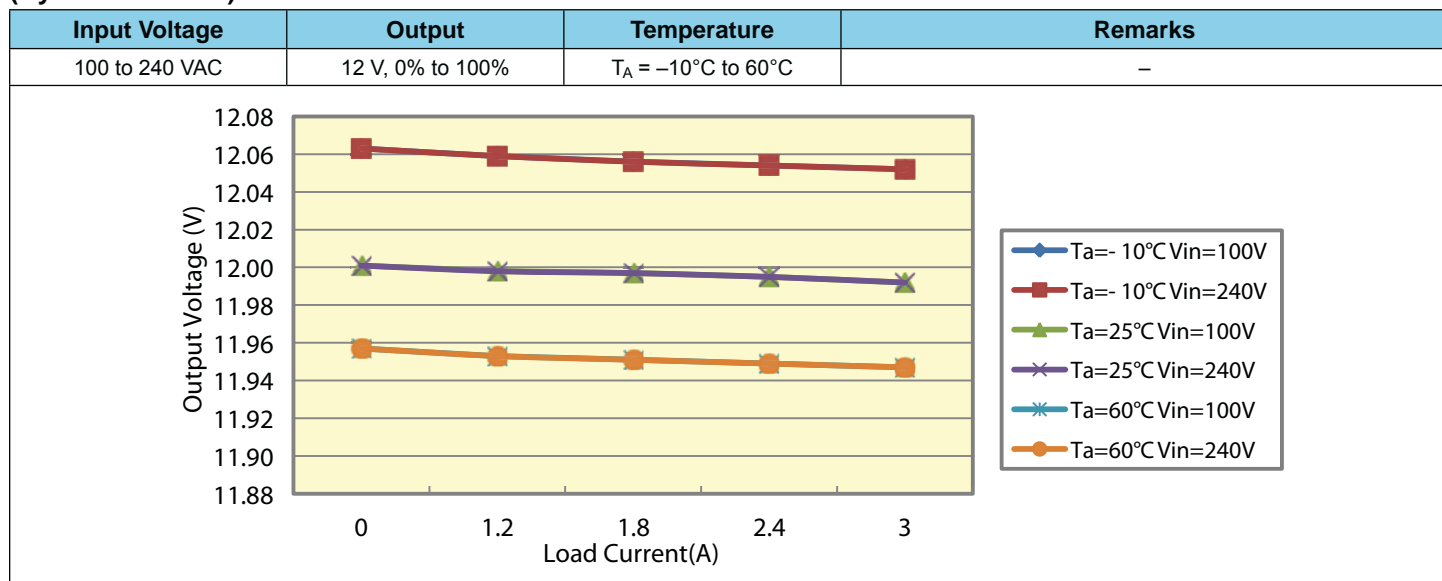

Figure 9. Output Voltage Rising

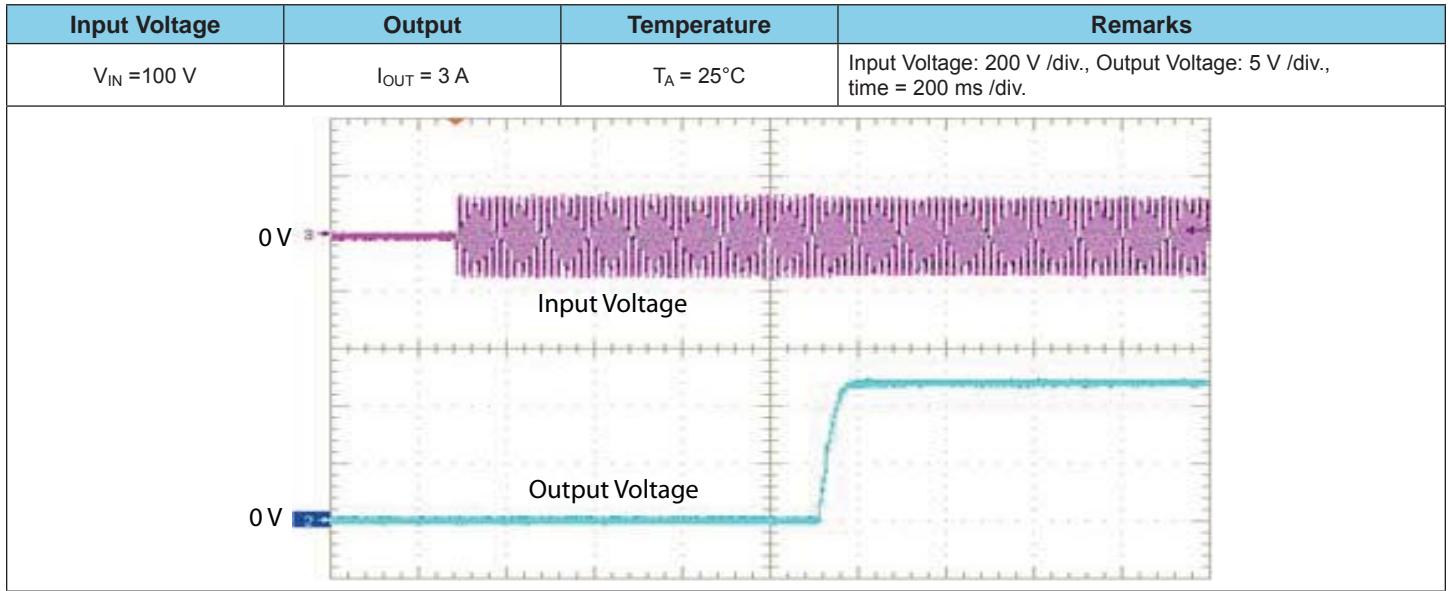

Figure 10. Output Voltage Falling

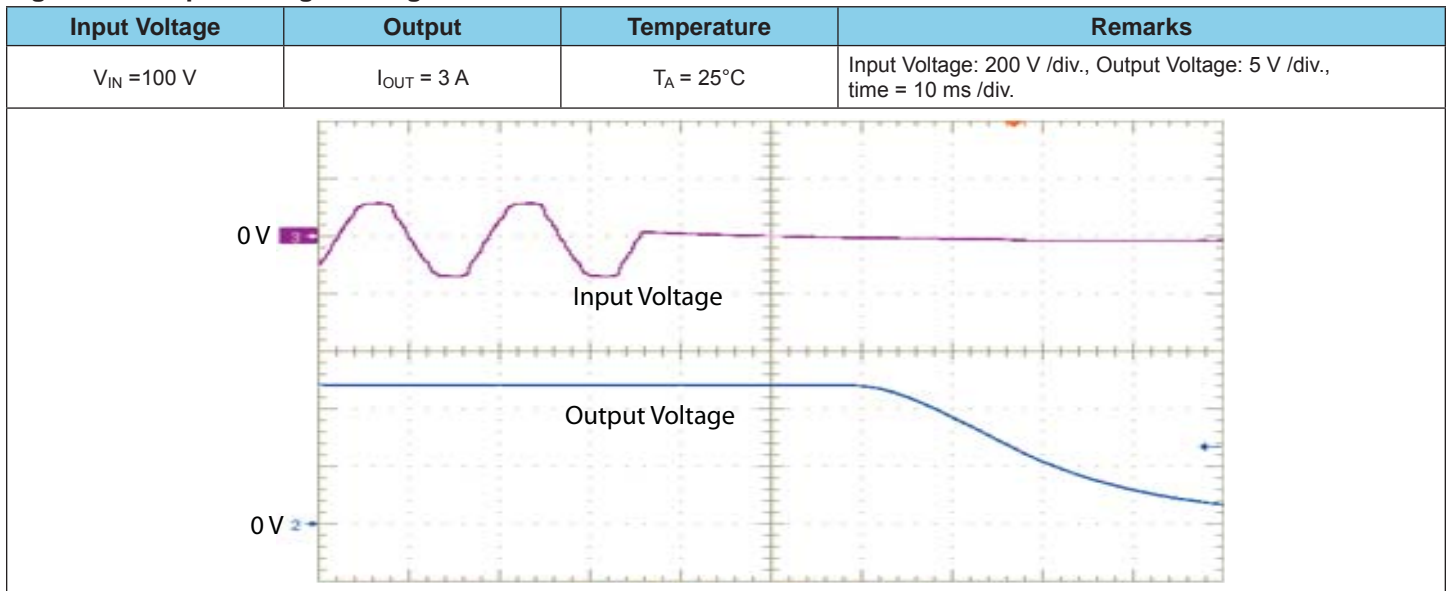

Figure 11. Warm-Up Drift

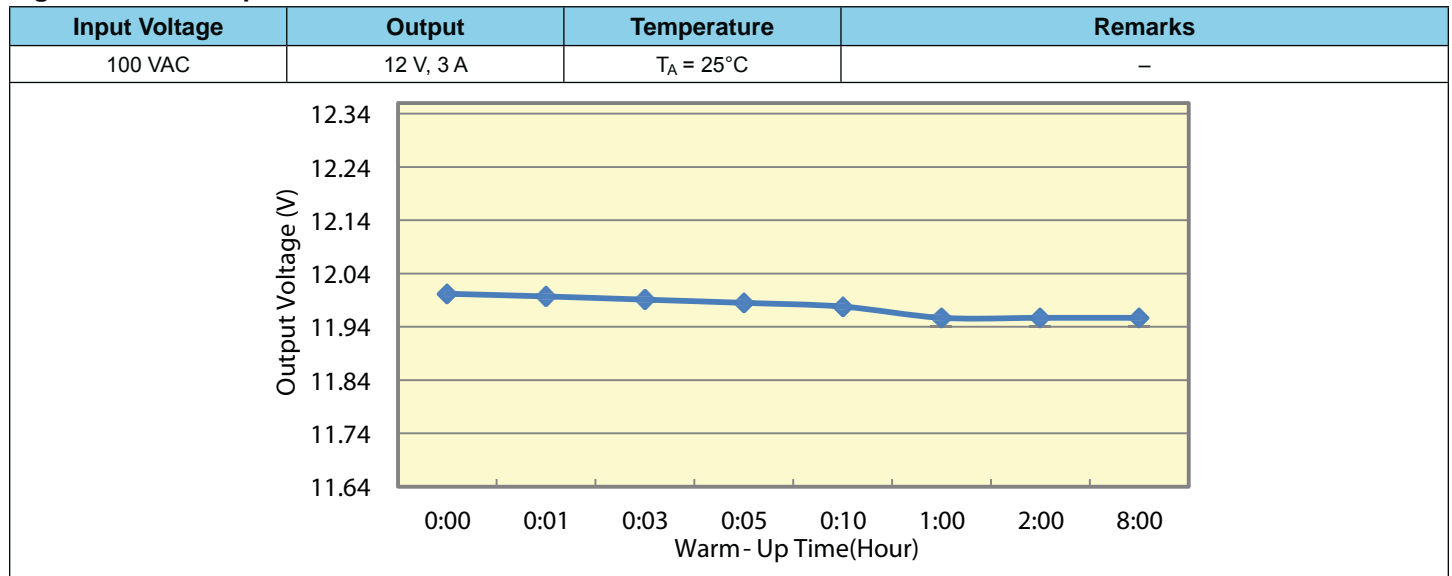
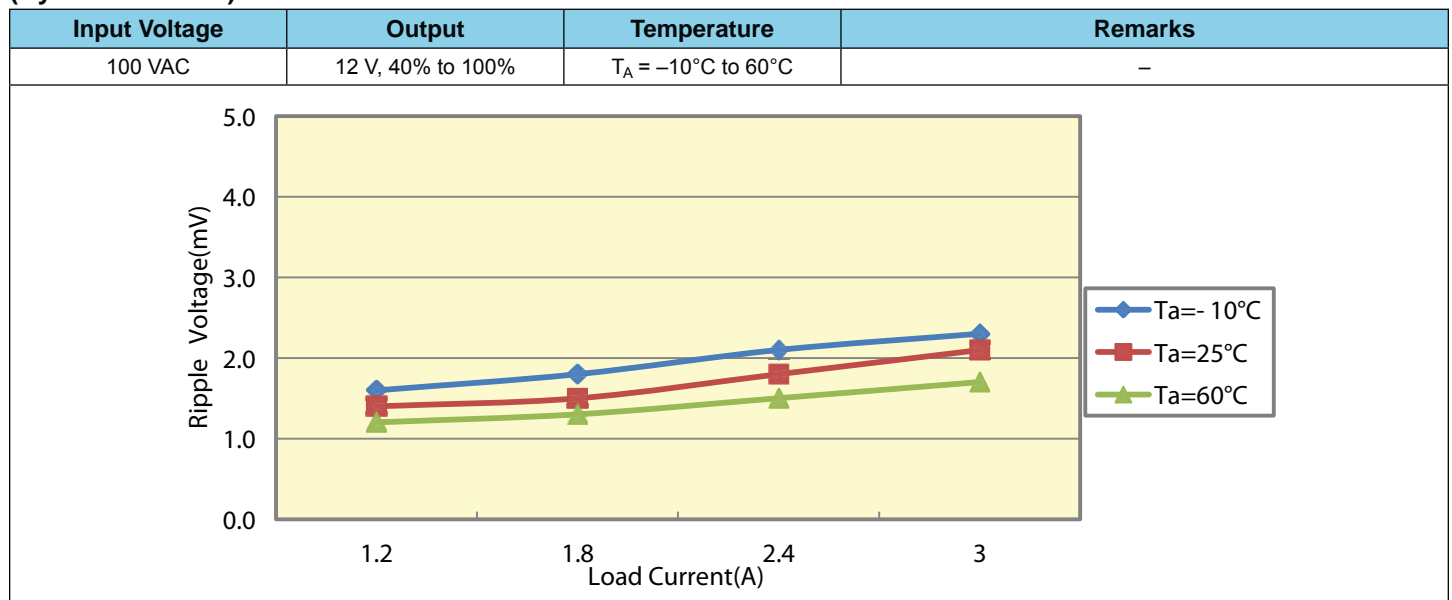

Figure 12. Ripple Voltage (By Load Current)



**Figure 13. Ripple Noise Voltage
(By Load Current)**

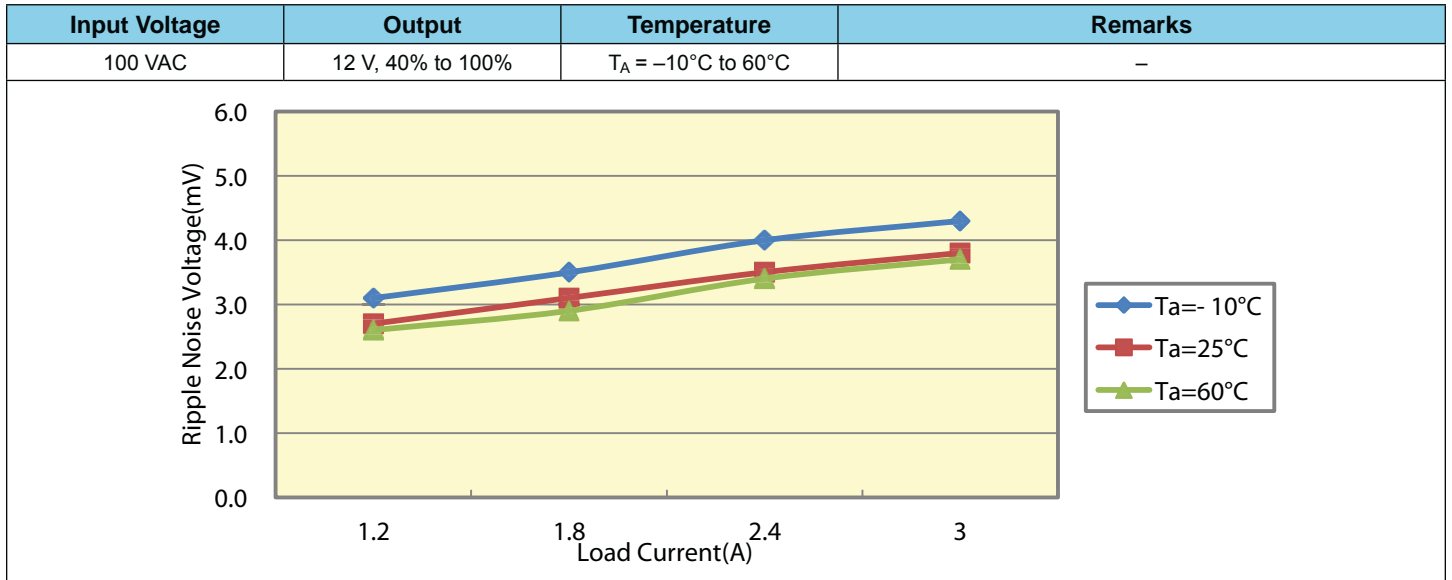

Table 3. Protection Characteristics

Test Item	Conditions		Test Results			Specifi- cation	Remarks
	V _{IN}	I _{LOAD}	T _A = -10°C	T _A = 25°C	T _A = 60°C		
Overcurrent Protection	Min	Max	4.21 A	4.03 A	3.85 A	-	Figure 14
Overvoltage Protection	Nom	Min	17.44 V	16.93 V	16.55 V	-	Figure 15
Reset Time	Max	Min	8.5 s at T _A = 25°C			-	-

**Figure 14. Overcurrent Protection
(By Load Current)**

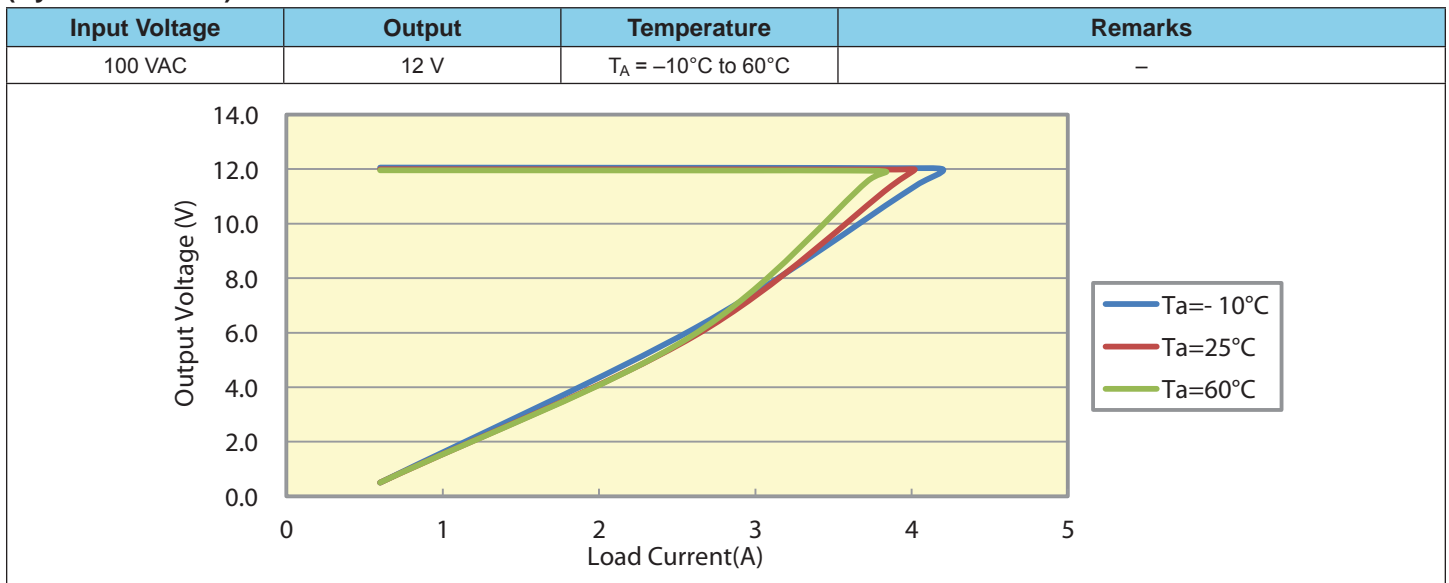

Figure 15. Overvoltage Protection (By Temperature)

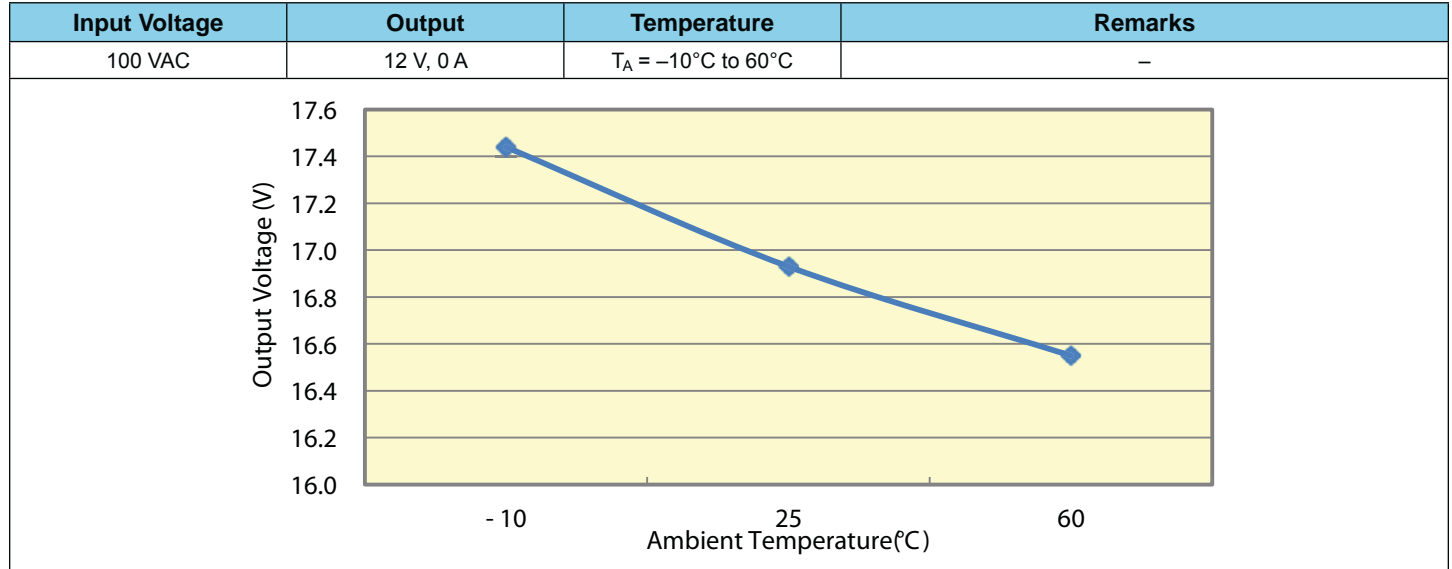
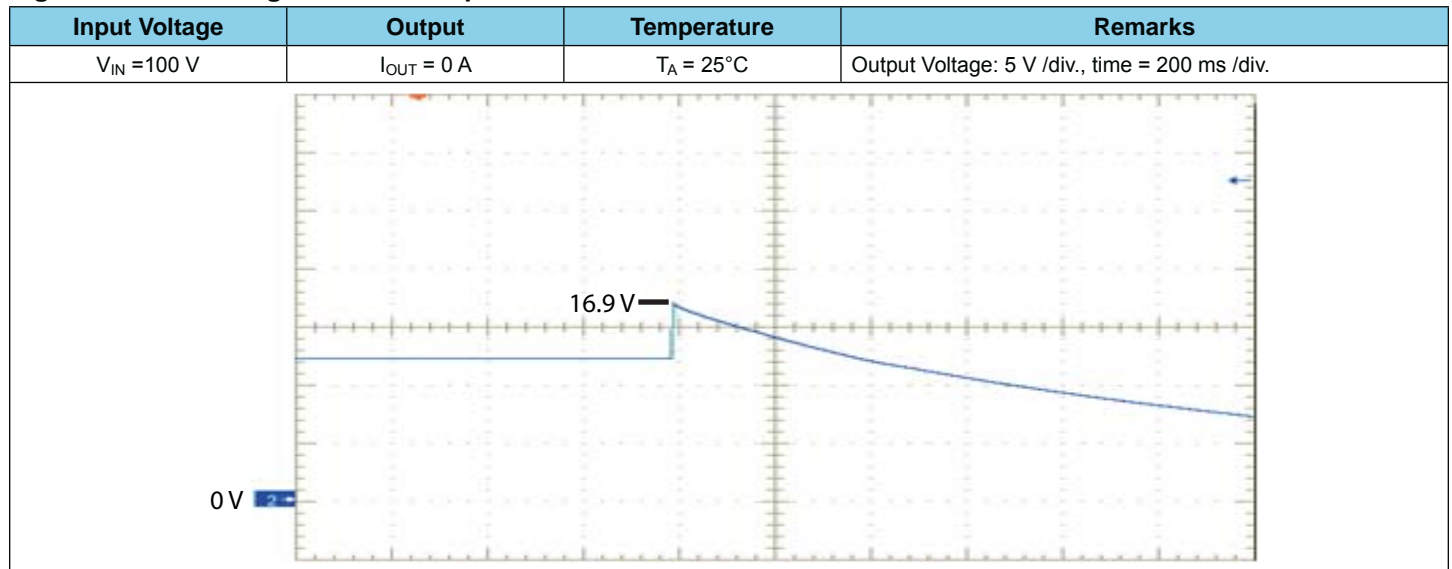

Figure 16. Overvoltage Protection Operation



**Figure 17. Start-Up Time
(By Input Voltage)**

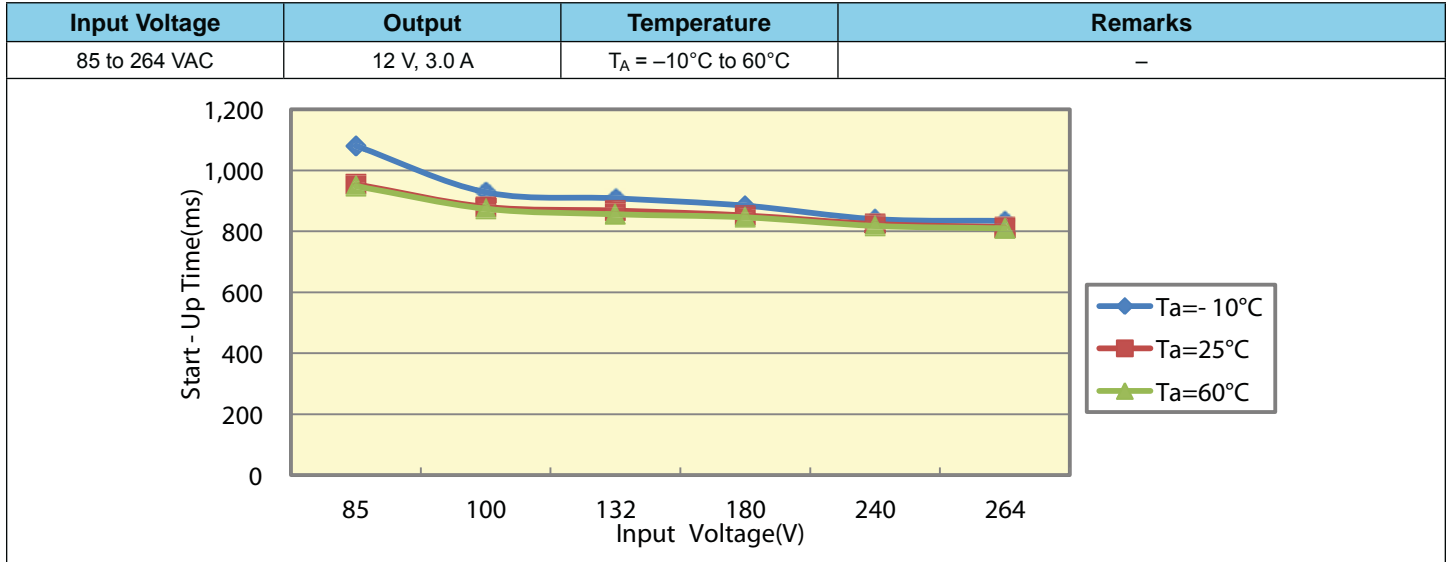

Table 4. Environment Tests
(At $T_A = 25^\circ\text{C}$)

Test Item	Conditions		Test Results	Specifi- cation	Remarks
	V _{IN}	I _{LOAD}			
Vibration (Non-Operating)	–	–	Frequency = 10 to 55 Hz, Sweep Cycle = 3 minutes, Acceleration = 19.6 m/s ² , Direction = x,y, and z axes at 60 minutes per axis	Normal operation	–
Power-On at High Temperature	Nom	Max	Power-off for 1 hour at 65°C, then power-on	Normal operation	–
Power-On at Low Temperature	Nom	Max	Power-off for 1 hour at –15°C, then power-on	Normal operation	–
Shock	–	–	Product is dropped from a height of 50 mm (98 m/s ²) onto a flat surface of wood (10 mm or thicker); the test is performed three times on each edge of the bottom side of the product	Normal operation	–

Table 5. Noise Tolerance Characteristics
(At $T_A = 25^\circ\text{C}$)

Test Item	Conditions		Test Results	Specification	Remarks
	V_{IN}	I_{LOAD}			
AC Line Noise (50 to 1000 ns)	Min to Max	Min to Max	Line to Line $\pm 1.44\text{ kV}$ OK	L-L 1.2 kV	-
	Min to Max	Min to Max	Line to Frame Ground $\pm 1.44\text{ kV}$ OK	L-FG 1.2 kV	-
Lightning Surge ($1.2 \times 50\ \mu\text{s}$)	Nom	Min to Max	Line to Line $\pm 2.88\text{ kV}$ OK	L-L 2.4 kV	-
	Nom	Min to Max	Line to Frame Ground $\pm 2.88\text{ kV}$ OK	L-FG 2.4 kV	-
Electrostatic Discharge	Min to Max	Min to Max	$\pm 21\text{ kV}$ OK at $R = 100\ \Omega$, $C = 500\ \text{pF}$	15 kV	-

Figure 18. Conduction Noise 100 V

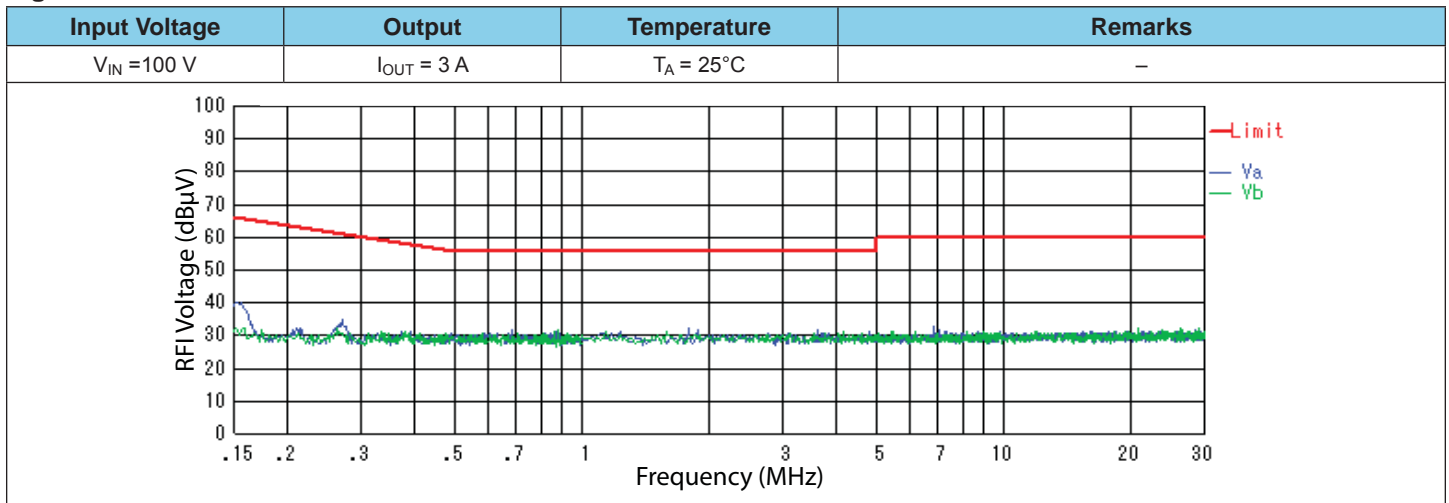

Figure 19. Conduction Noise 240 V

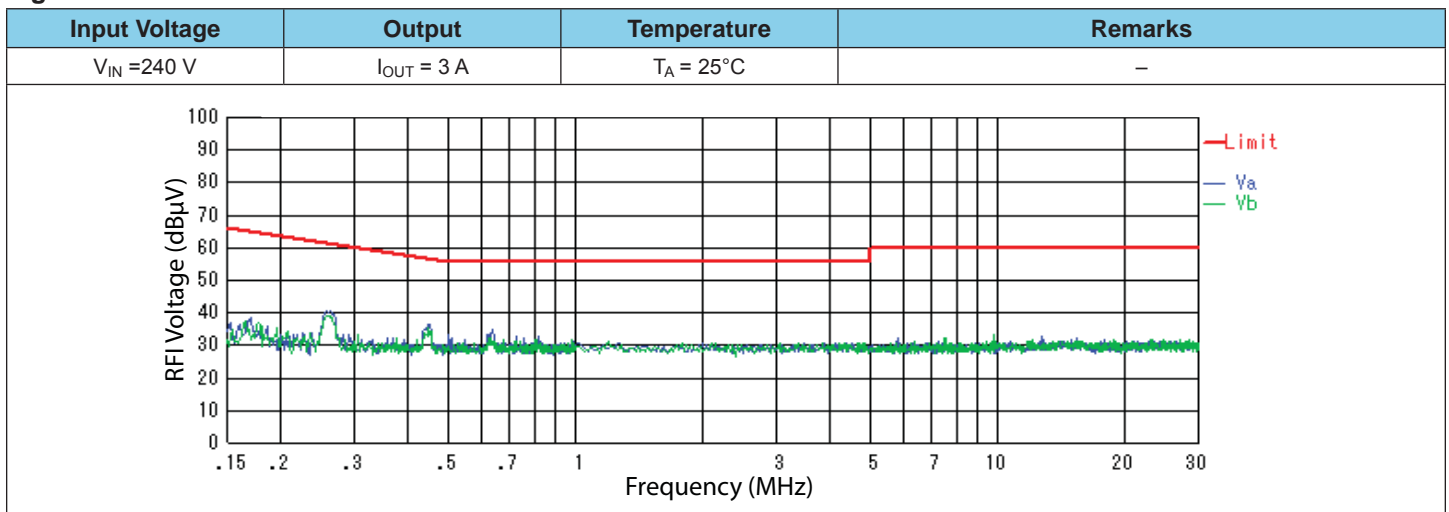

Table 6. Other Characteristics
(At $T_A = 25^\circ \text{C}$)

Test Item	Conditions		Test Results			Specification	Remarks
	V_{IN}	I_{LOAD}	P-S	P-E	S-E		
Withstand Voltage (Standard Model)	–	–	3.0 kV / 3.6 kV	1.5 kV / 1.8 kV	0.5 kV / 0.6 kV	P-S: 3 kV for 1 minute 3.6 kV for 1 second P-E: 1.5 kV for 1 minute 1.8 kV for 1 second S-E: 500 V for 1 minute 600 V for 1 second	–
Leakage Current at Withstand Voltage (Standard Model)	–	–	1.56 mA / 1.70 mA	1.20 mA / 1.36 mA	1.19 mA / 1.30 mA	$\leq 15 \text{ mA}$	–
Withstand Voltage (Medical Equipment Model)	–	–	4 kV	1.5 kV / 1.8 kV	0.5 kV / 0.6 kV	P-S: 4.0 kV for 1 minute P-E: 1.5 kV for 1 minute 1.8 kV for 1 second S-E: 500 V for 1 minute 600 V for 1 second	–
Leakage Current at Withstand Voltage (Medical Equipment Model)	–	–	1.01 mA	0.43 mA / 0.54 mA	1.22 mA / 1.34 mA	$\leq 15 \text{ mA}$	–
Insulation Resistance	–	–	$\geq 1000 \text{ M}\Omega$	$\geq 1000 \text{ M}\Omega$	$\geq 1000 \text{ M}\Omega$	$\geq 100 \text{ M}\Omega$ at 500 VDC Megger	–

Table 7. Output under Dynamic Load

Test Item	Conditions		Test Results			Specification	Remarks
	V _{IN}	I _{LOAD}	12 V				
Output Voltage at T _A = -10°C	Min	0 A to 3 A for 10 ms	11.78 V / 12.32 V			-	Figure 20
Output Voltage at T _A = 60°C	Min	0 A to 3 A for 10 ms	11.68 V / 12.22 V			-	Figure 20

Figure 20. Dynamic Load

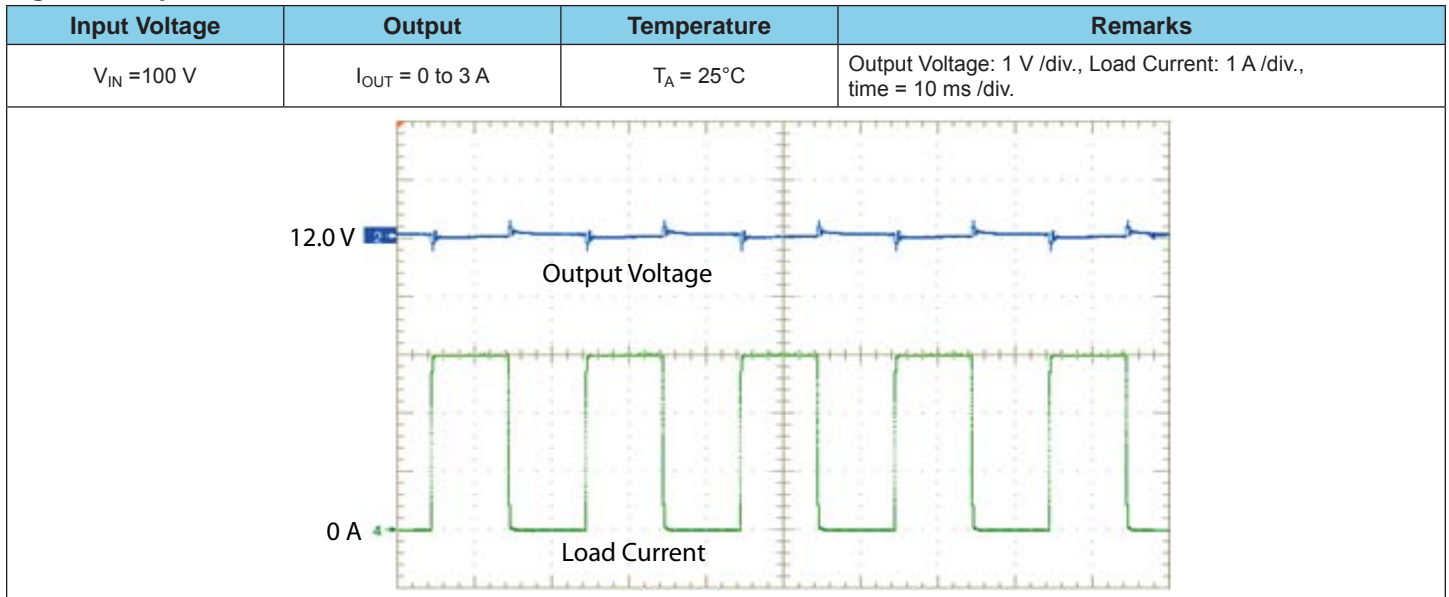

Important Information



- The products described in this document are built-in type DC stabilized power supplies with special structures and are designed for installation in equipment. Be sure to use the products only for installation in equipment.
- The products should be handled only by persons who have competent electrical knowledge.
- Be sure to read through all safety precaution and operation manuals before installation, operation, or maintenance and to use the products only for the intended use and in accordance with all applicable safety standards and regulations in the location of use.

Sanken reserves the right to make, from time to time, such departures from the detail specifications as may be required to permit improvements in the performance, reliability, or manufacturability of its products. Therefore, the user is cautioned to verify that the information in this publication is current before placing any order.

When using the products described herein, the applicability and suitability of such products for the intended purpose shall be reviewed at the users' responsibility.

Although Sanken undertakes to enhance the quality and reliability of its products, the occurrence of failure and defect of semiconductor products at a certain rate is inevitable.

Users of Sanken products are requested to take, at their own risk, preventative measures including safety design of the equipment or systems against any possible injury, death, fires or damages to society due to device failure or malfunction.

Sanken products listed in this publication are designed and intended for use as components in general-purpose electronic equipment or apparatus (home appliances, office equipment, telecommunication equipment, measuring equipment, etc.). Their use in any application requiring radiation hardness assurance (e.g., aerospace equipment) is not supported.

When considering the use of Sanken products in applications where higher reliability is required (transportation equipment and its control systems or equipment, fire- or burglar-alarm systems, various safety devices, etc.), contact a company sales representative to discuss and obtain written confirmation of your specifications.

The use of Sanken products without the written consent of Sanken in applications where extremely high reliability is required (aerospace equipment, nuclear power-control stations, life-support systems, etc.) is strictly prohibited.

The information included herein is believed to be accurate and reliable. Application and operation examples described in this publication are given for reference only and Sanken assumes no responsibility for any infringement of industrial property rights, intellectual property rights, or any other rights of Sanken or any third party that may result from its use. The contents in this document must not be transcribed or copied without Sanken's written consent.