

FEATURES

- Dual operational amplifier
- Voltage feedback
- Wide supply range from 3 V to 24 V
- Rail-to-rail output
 - Output swing to within 0.5 V of supply rails
- High linear output current
 - 310 mA peak into 32 Ω on ± 12 V supplies while maintaining -80 dBc SFDR
- Low noise
 - 4.5 nV/ $\sqrt{\text{Hz}}$ voltage noise density at 100 kHz
 - 1.5 pA/ $\sqrt{\text{Hz}}$ current noise density at 100 kHz
- High speed
 - 69 MHz bandwidth ($G = 1, -3$ dB)
 - 53 V/ μs slew rate ($R_{\text{LOAD}} = 25 \Omega$)

APPLICATIONS

- Twisted-pair line drivers
- Audio applications
- General-purpose ac applications

GENERAL DESCRIPTION

The AD8397 comprises two voltage feedback operational amplifiers capable of driving heavy loads with excellent linearity. The common-emitter, rail-to-rail output stage surpasses the output voltage capability of typical emitter-follower output stages and can swing to within 0.5 V of either rail while driving a 25 Ω load. The low distortion, high output current, and wide output dynamic range make the AD8397 ideal for applications that require a large signal swing into a heavy load.

Fabricated with Analog Devices, Inc., high speed extra fast complementary bipolar high voltage (XFCB-HV) process, the high bandwidth and fast slew rate of the AD8397 keep distortion to a minimum. The AD8397 is available in a standard 8-lead SOIC_N package and, for higher power dissipating applications, a thermally enhanced 8-lead SOIC_N_EP package. Both packages can operate from -40°C to $+85^\circ\text{C}$.

PIN CONFIGURATION

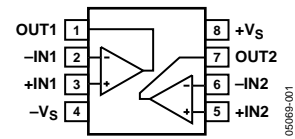

Figure 1. 8-Lead SOIC

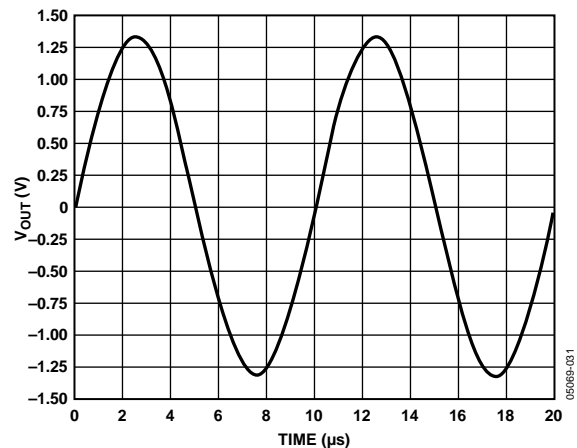

Figure 2. Output Swing, $V_S = \pm 1.5$ V, $R_L = 25 \Omega$

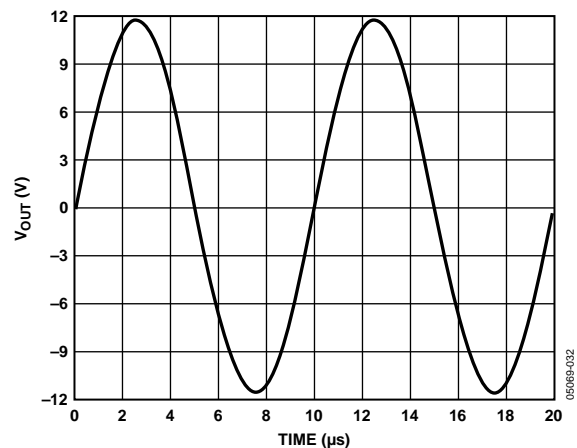

Figure 3. Output Swing, $V_S = \pm 12$ V, $R_L = 100 \Omega$

Rev. A

Information furnished by Analog Devices is believed to be accurate and reliable. However, no responsibility is assumed by Analog Devices for its use, nor for any infringements of patents or other rights of third parties that may result from its use. Specifications subject to change without notice. No license is granted by implication or otherwise under any patent or patent rights of Analog Devices. Trademarks and registered trademarks are the property of their respective owners.

AD8397* PRODUCT PAGE QUICK LINKS

Last Content Update: 02/23/2017

COMPARABLE PARTS

View a parametric search of comparable parts.

EVALUATION KITS

- Universal Evaluation Board for Dual High Speed Operational Amplifiers

DOCUMENTATION

Application Notes

- AN-1429: Design Considerations and Solutions for Headphone Drivers in Mobile Phones
- AN-1439: One-Stage Amplifier Design Consideration of a High Fidelity System
- AN-402: Replacing Output Clamping Op Amps with Input Clamping Amps
- AN-417: Fast Rail-to-Rail Operational Amplifiers Ease Design Constraints in Low Voltage High Speed Systems
- AN-581: Biasing and Decoupling Op Amps in Single Supply Applications

Data Sheet

- AD8397: Rail-to-Rail, High Output Current Amplifier Data Sheet

User Guides

- UG-128: Universal Evaluation Board for Dual High Speed Op Amps in SOIC Packages

TOOLS AND SIMULATIONS

- Analog Filter Wizard
- Analog Photodiode Wizard
- Power Dissipation vs Die Temp
- VRMS/dBm/dBu/dBV calculators
- AD8397 SPICE Macro Model

REFERENCE DESIGNS

- CN0276
- CN0317

REFERENCE MATERIALS

Product Selection Guide

- High Speed Amplifiers Selection Table

Tutorials

- MT-032: Ideal Voltage Feedback (VFB) Op Amp
- MT-033: Voltage Feedback Op Amp Gain and Bandwidth
- MT-047: Op Amp Noise
- MT-048: Op Amp Noise Relationships: 1/f Noise, RMS Noise, and Equivalent Noise Bandwidth
- MT-049: Op Amp Total Output Noise Calculations for Single-Pole System
- MT-050: Op Amp Total Output Noise Calculations for Second-Order System
- MT-052: Op Amp Noise Figure: Don't Be Misled
- MT-053: Op Amp Distortion: HD, THD, THD + N, IMD, SFDR, MTPR
- MT-056: High Speed Voltage Feedback Op Amps
- MT-058: Effects of Feedback Capacitance on VFB and CFB Op Amps
- MT-060: Choosing Between Voltage Feedback and Current Feedback Op Amps

DESIGN RESOURCES

- AD8397 Material Declaration
- PCN-PDN Information
- Quality And Reliability
- Symbols and Footprints

DISCUSSIONS

View all AD8397 EngineerZone Discussions.

SAMPLE AND BUY

Visit the product page to see pricing options.

TECHNICAL SUPPORT

Submit a technical question or find your regional support number.

DOCUMENT FEEDBACK

Submit feedback for this data sheet.

TABLE OF CONTENTS

Features	1	Typical Performance Characteristics	8
Applications.....	1	Applications Information	11
General Description	1	Power Supply and Decoupling.....	11
Pin Configuration.....	1	Layout Considerations.....	11
Revision History	2	Unity-Gain Output Swing.....	11
Specifications.....	3	Capacitive Load Drive	12
Absolute Maximum Ratings.....	7	Outline Dimensions	13
Maximum Power Dissipation	7	Ordering Guide	13
ESD Caution.....	7		

REVISION HISTORY

5/11—Rev. 0 to Rev. A

Changes to Applications Section and General Description Section.....	1
Changed Maximum Output Current Parameter to Peak AC Output Current Parameter, Table 1.....	3
Added Note 1 and Note 2, Table 1.....	3
Changed Maximum Output Current Parameter to Peak AC Output Current Parameter, Table 2.....	4
Added Note 1 and Note 2, Table 2.....	4
Changed Maximum Output Current Parameter to Peak AC Output Current Parameter, Table 3.....	5
Added Note 1 and Note 2, Table 3.....	5
Changed Maximum Output Current Parameter to Peak AC Output Current Parameter, Table 4.....	6
Added Note 1 and Note 2, Table 4.....	6
Changes to Figure 4.....	7
Changed General Description Section to Applications Information Section	11
Updated Outline Dimensions	13

1/05—Revision 0: Initial Version

SPECIFICATIONS

$V_S = \pm 1.5\text{ V}$ or $+3\text{ V}$ (at $T_A = 25^\circ\text{C}$, $G = +1$, $R_L = 25\ \Omega$, unless otherwise noted)¹.

Table 1.

Parameter	Test Conditions/Comments	Min	Typ	Max	Unit
DYNAMIC PERFORMANCE					
–3 dB Bandwidth	$V_{OUT} = 0.1\text{ V p-p}$		50		MHz
0.1 dB Flatness	$V_{OUT} = 0.1\text{ V p-p}$		3.6		MHz
Large Signal Bandwidth	$V_{OUT} = 2.0\text{ V p-p}$		9		MHz
Slew Rate	$V_{OUT} = 0.8\text{ V p-p}$		32		V/ μs
NOISE/DISTORTION PERFORMANCE					
Distortion (Worst Harmonic)	$f_c = 100\text{ kHz}$, $V_{OUT} = 1.4\text{ V p-p}$, $G = +2$		–90		dBc
Input Voltage Noise	$f = 100\text{ kHz}$		4.5		nV/ $\sqrt{\text{Hz}}$
Input Current Noise	$f = 100\text{ kHz}$		1.5		pA/ $\sqrt{\text{Hz}}$
DC PERFORMANCE					
Input Offset Voltage	$T_{MIN} - T_{MAX}$		1.0	2.5	mV
Input Offset Voltage Match			2.5		mV
Input Bias Current	$T_{MIN} - T_{MAX}$		1.0	2.0	mV
Input Offset Current			200	900	nA
Open-Loop Gain	$V_{OUT} = \pm 0.5\text{ V}$	81	88		dB
INPUT CHARACTERISTICS					
Input Resistance	$f = 100\text{ kHz}$		87		k Ω
Input Capacitance			1.4		pF
Common-Mode Rejection	$\Delta V_{CM} = \pm 1\text{ V}$	–71	–80		dB
OUTPUT CHARACTERISTICS					
Output Resistance			0.2		Ω
+Swing	$R_{LOAD} = 25\ \Omega$	+1.39	+1.43		V _P
–Swing	$R_{LOAD} = 25\ \Omega$		–1.4	–1.37	V _P
+Swing	$R_{LOAD} = 100\ \Omega$	+1.45	+1.48		V _P
–Swing	$R_{LOAD} = 100\ \Omega$		–1.47	–1.44	V _P
Peak AC Output Current ²	SFDR $\leq -70\text{ dBc}$, $f = 100\text{ kHz}$, $V_{OUT} = 0.7\text{ V}_P$, $R_{LOAD} = 4.1\ \Omega$		170		mA
POWER SUPPLY					
Operating Range (Dual Supply)		± 1.5		± 12.0	V
Supply Current		6	7	8.5	mA/Amp
Power Supply Rejection	$\Delta V_S = \pm 0.5\text{ V}$	–70	–82		dB

¹ Unity gain used to facilitate characterization. To improve stability, a gain of 2 or greater is recommended.

² Peak ac output current specification assumes normal ac operation and is not valid for continuous dc operation.

AD8397

$V_S = \pm 2.5V$ or $+5V$ (at $T_A = 25^\circ C$, $G = +1$, $R_L = 25\ \Omega$, unless otherwise noted)¹.

Table 2.

Parameter	Test Conditions/Comments	Min	Typ	Max	Unit
DYNAMIC PERFORMANCE					
–3 dB Bandwidth	$V_{OUT} = 0.1\ V\ p-p$		60		MHz
0.1 dB Flatness	$V_{OUT} = 0.1\ V\ p-p$		4.8		MHz
Large Signal Bandwidth	$V_{OUT} = 2.0\ V\ p-p$		14		MHz
Slew Rate	$V_{OUT} = 2.0\ V\ p-p$		53		V/ μs
NOISE/DISTORTION PERFORMANCE					
Distortion (Worst Harmonic)	$f_c = 100\ kHz$, $V_{OUT} = 2\ V\ p-p$, $G = +2$		–98		dBc
Input Voltage Noise	$f = 100\ kHz$		4.5		nV/ \sqrt{Hz}
Input Current Noise	$f = 100\ kHz$		1.5		pA/ \sqrt{Hz}
DC PERFORMANCE					
Input Offset Voltage	$T_{MIN} - T_{MAX}$		1.0	2.4	mV
			2.5		mV
Input Offset Voltage Match			1.0	2.0	mV
Input Bias Current	$T_{MIN} - T_{MAX}$		200	900	nA
				1.3	
Input Offset Current			50	300	nA
Open-Loop Gain	$V_{OUT} = \pm 1.0\ V$	85	90		dB
INPUT CHARACTERISTICS					
Input Resistance	$f = 100\ kHz$		87		k Ω
Input Capacitance			1.4		pF
Common-Mode Rejection	$\Delta V_{CM} = \pm 1\ V$	–76	–80		dB
OUTPUT CHARACTERISTICS					
Output Resistance			0.2		Ω
+Swing	$R_{LOAD} = 25\ \Omega$	+2.37	+2.42		V _P
–Swing	$R_{LOAD} = 25\ \Omega$		–2.37	–2.32	V _P
+Swing	$R_{LOAD} = 100\ \Omega$	+2.45	+2.48		V _P
–Swing	$R_{LOAD} = 100\ \Omega$		–2.46	–2.42	V _P
Peak AC Output Current ²	SFDR $\leq -70\ dBc$, $f = 100\ kHz$, $V_{OUT} = 1.0\ V_P$, $R_{LOAD} = 4.3\ \Omega$		230		mA
POWER SUPPLY					
Operating Range (Dual Supply)		± 1.5		± 12.6	V
Supply Current		7	9	12	mA/Amp
Power Supply Rejection	$\Delta V_S = \pm 0.5\ V$	–75	–85		dB

¹ Unity gain used to facilitate characterization. To improve stability, a gain of 2 or greater is recommended.

² Peak ac output current specification assumes normal ac operation and is not valid for continuous dc operation.

$V_S = \pm 5\text{ V}$ or $+10\text{ V}$ (at $T_A = 25^\circ\text{C}$, $G = +1$, $R_L = 25\ \Omega$, unless otherwise noted)¹.

Table 3.

Parameter	Test Conditions/Comments	Min	Typ	Max	Unit
DYNAMIC PERFORMANCE					
–3 dB Bandwidth	$V_{OUT} = 0.1\text{ V p-p}$		66		MHz
0.1 dB Flatness	$V_{OUT} = 0.1\text{ V p-p}$		6.5		MHz
Large Signal Bandwidth	$V_{OUT} = 2.0\text{ V p-p}$		14		MHz
Slew Rate	$V_{OUT} = 4.0\text{ V p-p}$		53		V/ μs
NOISE/DISTORTION PERFORMANCE					
Distortion (Worst Harmonic)	$f_C = 100\text{ kHz}$, $V_{OUT} = 6\text{ V p-p}$, $G = +2$		–94		dBc
Input Voltage Noise	$f = 100\text{ kHz}$		4.5		nV/ $\sqrt{\text{Hz}}$
Input Current Noise	$f = 100\text{ kHz}$		1.5		pA/ $\sqrt{\text{Hz}}$
DC PERFORMANCE					
Input Offset Voltage	$T_{MIN} - T_{MAX}$		1.0	2.5	mV
Input Offset Voltage Match			2.5		mV
Input Bias Current	$T_{MIN} - T_{MAX}$		1.0	2.0	mV
Input Offset Current			200	900	nA
Open-Loop Gain	$V_{OUT} = \pm 2.0\text{ V}$	85	94		dB
INPUT CHARACTERISTICS					
Input Resistance	$f = 100\text{ kHz}$		87		k Ω
Input Capacitance			1.4		pF
Common-Mode Rejection	$\Delta V_{CM} = \pm 1\text{ V}$	–84	–94		dB
OUTPUT CHARACTERISTICS					
Output Resistance			0.2		Ω
+Swing	$R_{LOAD} = 25\ \Omega$	+4.7	+4.82		V _P
–Swing	$R_{LOAD} = 25\ \Omega$		–4.74	–4.65	V _P
+Swing	$R_{LOAD} = 100\ \Omega$	+4.92	+4.96		V _P
–Swing	$R_{LOAD} = 100\ \Omega$		–4.92	–4.88	V _P
Peak AC Output Current ²	SFDR $\leq -80\text{ dBc}$, $f = 100\text{ kHz}$, $V_{OUT} = 3\text{ V}_P$, $R_{LOAD} = 12\ \Omega$		250		mA
POWER SUPPLY					
Operating Range (Dual Supply)		± 1.5		± 12.6	V
Supply Current		7	9	12	mA/Amp
Power Supply Rejection	$\Delta V_S = \pm 0.5\text{ V}$	–76	–85		dB

¹ Unity gain used to facilitate characterization. To improve stability, a gain of 2 or greater is recommended.

² Peak ac output current specification assumes normal ac operation and is not valid for continuous dc operation.

AD8397

$V_S = \pm 12\text{ V}$ or $+24\text{ V}$ (at $T_A = 25^\circ\text{C}$, $G = +1$, $R_L = 25\ \Omega$, unless otherwise noted)¹.

Table 4.

Parameter	Test Conditions/Comments	Min	Typ	Max	Unit
DYNAMIC PERFORMANCE					
–3 dB Bandwidth	$V_{OUT} = 0.1\text{ V p-p}$		69		MHz
0.1 dB Flatness	$V_{OUT} = 0.1\text{ V p-p}$		7.6		MHz
Large Signal Bandwidth	$V_{OUT} = 2.0\text{ V p-p}$		14		MHz
Slew Rate	$V_{OUT} = 4.0\text{ V p-p}$		53		V/ μs
NOISE/DISTORTION PERFORMANCE					
Distortion (Worst Harmonic)	$f_C = 100\text{ kHz}$, $V_{OUT} = 20\text{ V p-p}$, $G = +5$		–84		dBc
Input Voltage Noise	$f = 100\text{ kHz}$		4.5		nV/ $\sqrt{\text{Hz}}$
Input Current Noise	$f = 100\text{ kHz}$		1.5		pA/ $\sqrt{\text{Hz}}$
DC PERFORMANCE					
Input Offset Voltage	$T_{MIN} - T_{MAX}$		1.0	3.0	mV
Input Offset Voltage Match			2.5		mV
Input Bias Current	$T_{MIN} - T_{MAX}$		1.0	2.0	mV
Input Offset Current			200	900	nA
Open-Loop Gain	$V_{OUT} = \pm 3.0\text{ V}$	90	96	300	dB
INPUT CHARACTERISTICS					
Input Resistance	$f = 100\text{ kHz}$		87		k Ω
Input Capacitance			1.4		pF
Common-Mode Rejection	$\Delta V_{CM} = \pm 1\text{ V}$	–85	–96		dB
OUTPUT CHARACTERISTICS					
Output Resistance			0.2		Ω
+Swing	$R_{LOAD} = 100\ \Omega$	+11.82	+11.89		V _p
–Swing	$R_{LOAD} = 100\ \Omega$		–11.83	–11.77	V _p
Peak AC Output Current ²	SFDR $\leq -80\text{ dBc}$, $f = 100\text{ kHz}$, $V_{OUT} = 10\text{ V}_p$, $R_{LOAD} = 32\ \Omega$		310		mA
POWER SUPPLY					
Operating Range (Dual Supply)		± 1.5		± 12.6	V
Supply Current		8.5	11	15	mA/Amp
Power Supply Rejection	$\Delta V_S = \pm 0.5\text{ V}$	–76	–86		dB

¹ Unity gain used to facilitate characterization. To improve stability, a gain of 2 or greater is recommended.

² Peak ac output current specification assumes normal ac operation and is not valid for continuous dc operation.

ABSOLUTE MAXIMUM RATINGS

Table 5.

Parameter	Rating
Supply Voltage	26.4 V
Power Dissipation ¹	See Figure 4
Storage Temperature Range	−65°C to +125°C
Operating Temperature Range	−40°C to +85°C
Lead Temperature (Soldering, 10 sec)	300°C
Junction Temperature	150°C

Stresses above those listed under Absolute Maximum Ratings may cause permanent damage to the device. This is a stress rating only; functional operation of the device at these or any other conditions above those indicated in the operational section of this specification is not implied. Exposure to absolute maximum rating conditions for extended periods may affect device reliability.

¹ Thermal resistance for standard JEDEC 4-layer board:
 8-lead SOIC_N: $\theta_{JA} = 157.6^{\circ}\text{C}/\text{W}$
 8-Lead SOIC_N_EP: $\theta_{JA} = 47.2^{\circ}\text{C}/\text{W}$

MAXIMUM POWER DISSIPATION

The maximum power that can be dissipated safely by the AD8397 is limited by the associated rise in junction temperature. The maximum safe junction temperature for plastic encapsulated devices is determined by the glass transition temperature of the plastic, approximately 150°C. Temporarily exceeding this limit may cause a shift in parametric performance due to a change in the stresses exerted on the die by the package.

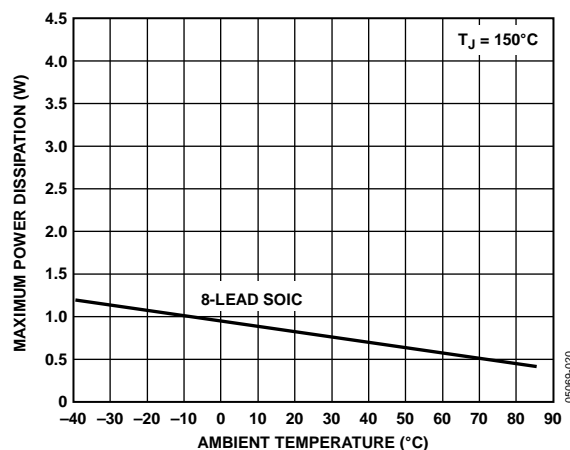

Figure 4. Maximum Power Dissipation vs. Ambient Temperature

ESD CAUTION



ESD (electrostatic discharge) sensitive device. Charged devices and circuit boards can discharge without detection. Although this product features patented or proprietary protection circuitry, damage may occur on devices subjected to high energy ESD. Therefore, proper ESD precautions should be taken to avoid performance degradation or loss of functionality.

TYPICAL PERFORMANCE CHARACTERISTICS

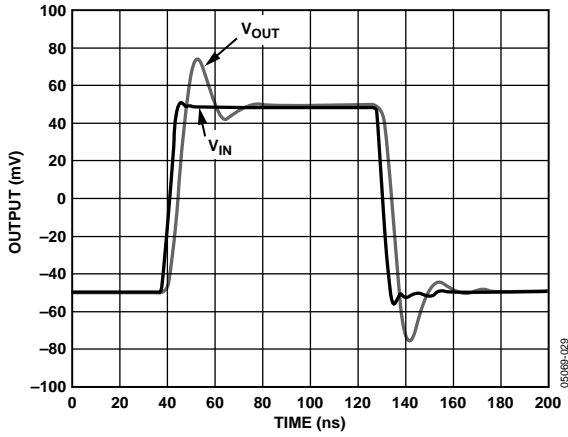

Figure 5. Small Signal Pulse Response ($G = +1$, $V_S = \pm 5\text{ V}$, $R_L = 25\ \Omega$)

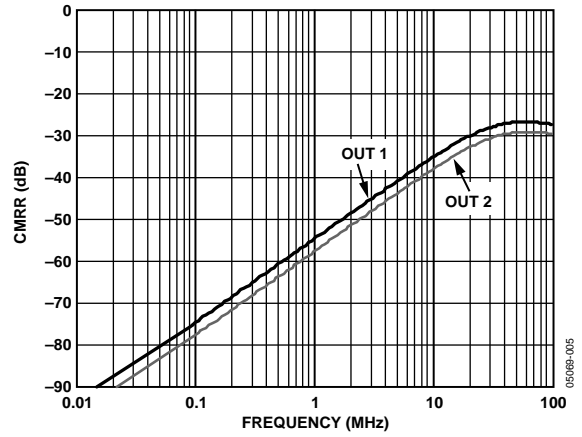

Figure 8. Common-Mode Rejection (CMRR) vs. Frequency ($V_S = \pm 5\text{ V}$, $R_L = 25\ \Omega$)

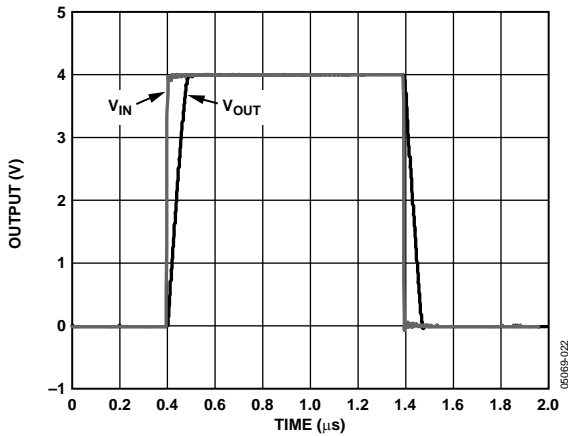

Figure 6. Large Signal Pulse Response (0 V to 4 V, $V_S = \pm 5\text{ V}$, $R_L = 25\ \Omega$)

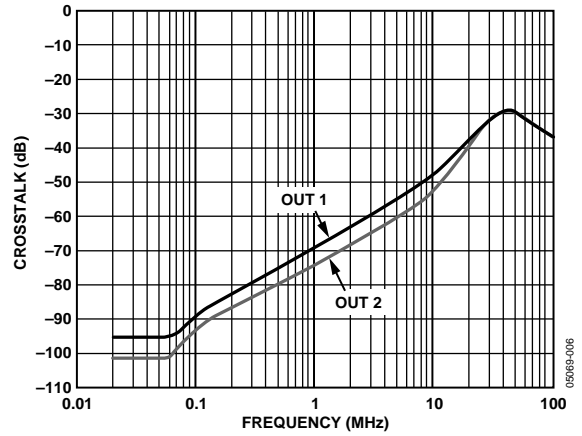

Figure 9. Output-to-Output Crosstalk vs. Frequency ($V_S = \pm 5\text{ V}$, $V_O = 1\text{ V p-p}$, $R_L = 25\ \Omega$)

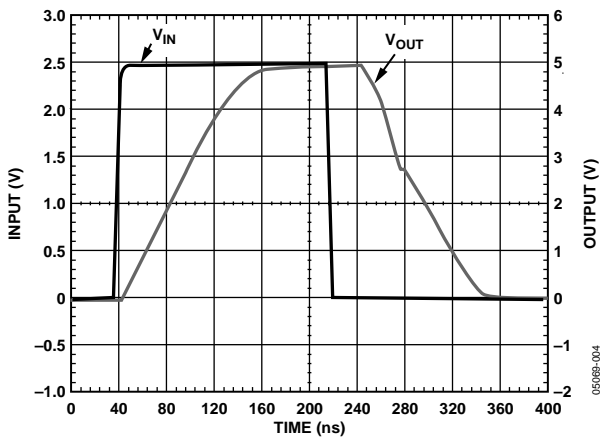

Figure 7. Output Overdrive Recovery ($V_S = \pm 5\text{ V}$, Gain = +2, $R_L = 25\ \Omega$)

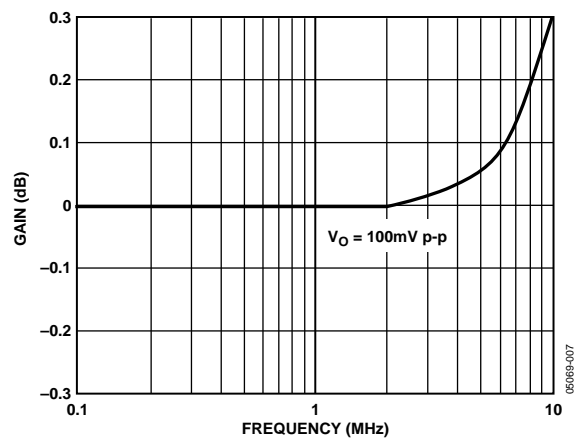

Figure 10. 0.1 dB Flatness ($V_S = \pm 5\text{ V}$, $V_O = 0.1\text{ V p-p}$, Gain = +1, $R_L = 25\ \Omega$)

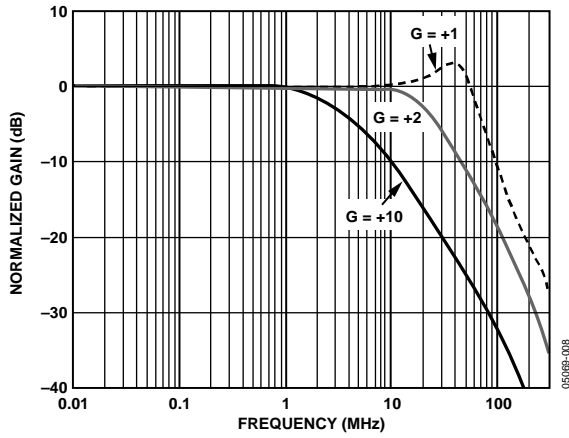

Figure 11. Small Signal Frequency Response for Various Gains ($V_S = \pm 5 V$, $V_O = 0.1 V$ p-p, $R_L = 25 \Omega$)

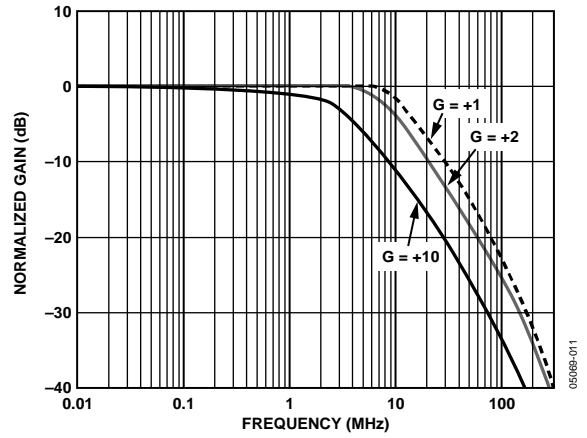

Figure 14. Large Signal Frequency Response for Various Gains ($V_S = \pm 5 V$, $V_O = 2 V$ p-p, $R_L = 25 \Omega$)

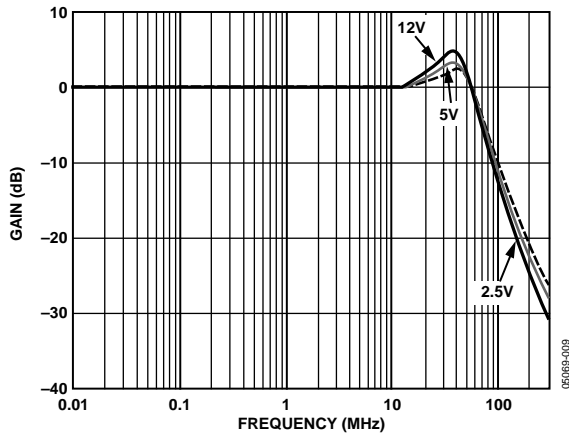

Figure 12. Small Signal Frequency Response for Various Supplies (Gain = +1, $V_O = 0.1 V$ p-p, $R_L = 25 \Omega$)

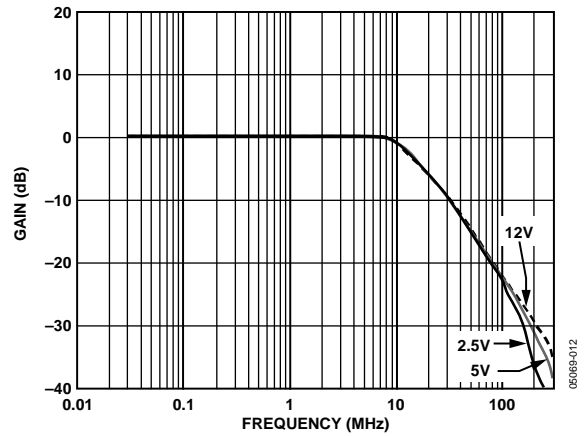

Figure 15. Large Signal Frequency Response for Various Supplies (Gain = +1, $V_O = 2 V$ p-p, $R_L = 25 \Omega$)

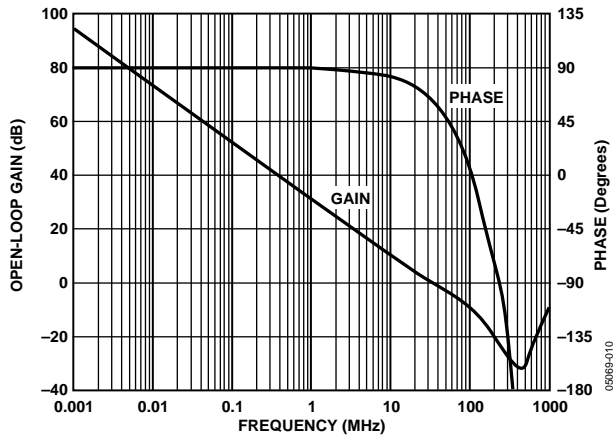

Figure 13. Open Loop Gain and Phase vs. Frequency ($V_S = \pm 5 V$, $R_L = 25 \Omega$)

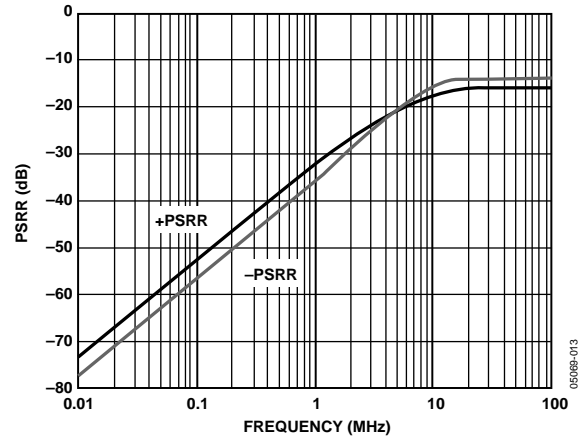

Figure 16. Power Supply Rejection Ratio (PSRR) vs. Frequency ($V_S = \pm 5 V$, $R_L = 25 \Omega$)

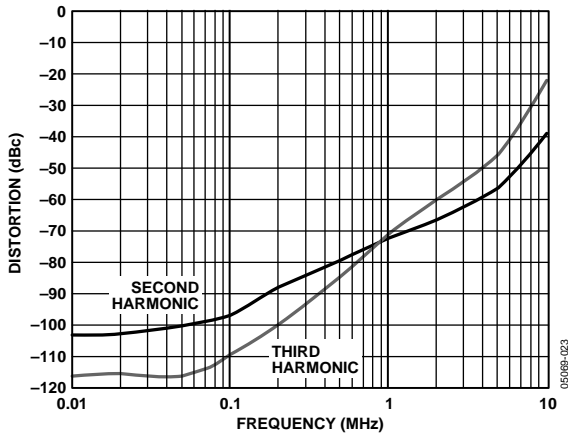

Figure 17. Distortion vs. Frequency
 ($V_S = \pm 5\text{ V}$, $V_O = 2\text{ V p-p}$, $G = +2$, $R_L = 25\ \Omega$)

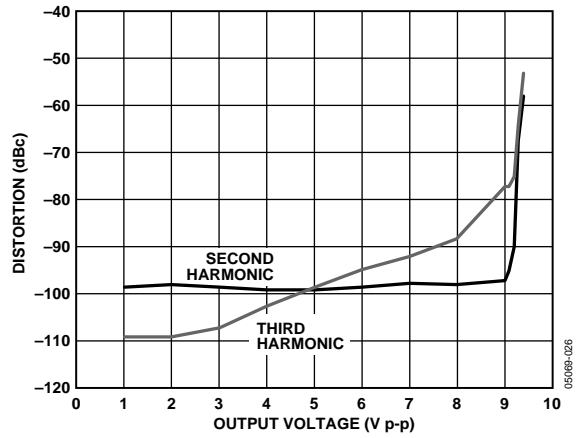

Figure 20. Distortion vs. Output Voltage @ 100 kHz,
 ($V_S = \pm 5\text{ V}$, $G = +2$, $R_L = 25\ \Omega$)

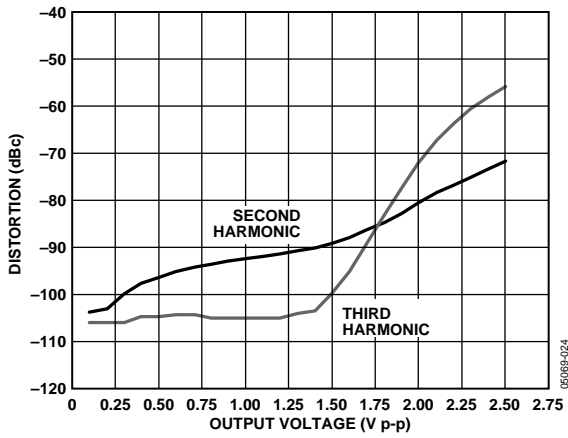

Figure 18. Distortion vs. Output Voltage @ 100 kHz,
 ($V_S = \pm 1.5\text{ V}$, $G = +2$, $R_L = 25\ \Omega$)

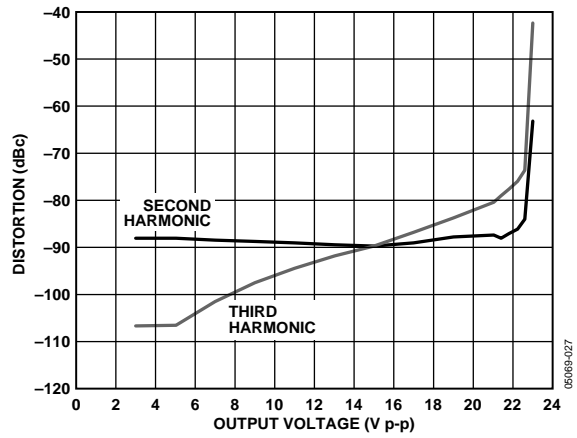

Figure 21. Distortion vs. Output Voltage @ 100 kHz,
 ($V_S = \pm 12\text{ V}$, $G = +5$, $R_L = 50\ \Omega$)

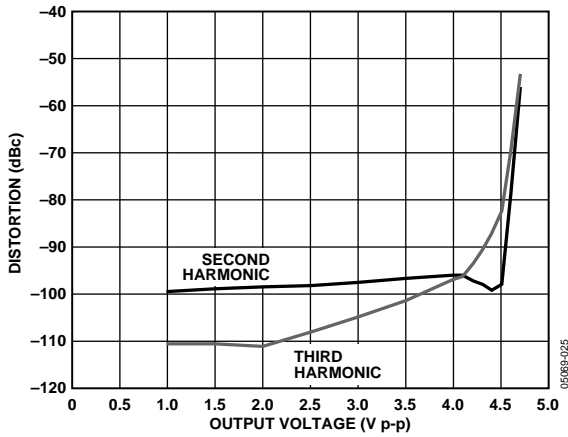

Figure 19. Distortion vs. Output Voltage @ 100 kHz,
 ($V_S = \pm 2.5\text{ V}$, $G = +2$, $R_L = 25\ \Omega$)

APPLICATIONS INFORMATION

The AD8397 is a voltage feedback operational amplifier that features an H-bridge input stage and common-emitter, rail-to-rail output stage. The AD8397 can operate from a wide supply range, ± 1.5 V to ± 12 V. When driving light loads, the rail-to-rail output is capable of swinging to within 0.2 V of either rail. The output can also deliver high linear output current when driving heavy loads, up to 310 mA into $32\ \Omega$ while maintaining -80 dBc SFDR. The AD8397 is fabricated on Analog Devices proprietary XFCB-HV.

POWER SUPPLY AND DECOUPLING

The AD8397 can be powered with a good quality, well-regulated, low noise supply from ± 1.5 V to ± 12 V. Pay careful attention to decoupling the power supply. Use high quality capacitors with low equivalent series resistance (ESR), such as multilayer ceramic capacitors (MLCCs), to minimize the supply voltage ripple and power dissipation. Locate a 0.1 μ F MLCC decoupling capacitor(s) no more than 1/8 inch away from the power supply pin(s). A large tantalum 10 μ F to 47 μ F capacitor is recommended to provide good decoupling for lower frequency signals and to supply current for fast, large signal changes at the AD8397 outputs.

LAYOUT CONSIDERATIONS

As with all high speed applications, pay careful attention to printed circuit board (PCB) layout to prevent associated board parasitics from becoming problematic. The PCB should have a low impedance return path (or ground) to the supply. Removing the ground plane from all layers in the immediate area of the amplifier helps to reduce stray capacitances. The signal routing should be short and direct in order to minimize the parasitic inductance and capacitance associated with these traces. Locate termination resistors and loads as close as possible to their respective inputs and outputs. Keep input traces as far apart as possible from the output traces to minimize coupling (crosstalk) though the board.

When the AD8397 is configured as a differential driver, as in some line driving applications, provide a symmetrical layout to the extent possible in order to maximize balanced performance. When running differential signals over a long distance, the traces on the PCB should be close together or any differential wiring should be twisted together to minimize the area of the inductive loop that is formed. This reduces the radiated energy and makes the circuit less susceptible to RF interference. Adherence to stripline design techniques for long signal traces (greater than approximately 1 inch) is recommended.

UNITY-GAIN OUTPUT SWING

When operating the AD8397 in a unity-gain configuration, the output does not swing to the rails and is constrained by the H-bridge input. This can be seen by comparing the output overdrive recovery in Figure 7 and the input overdrive recovery in Figure 22. To avoid overdriving the input and to realize the full swing afforded by the rail-to-rail output stage, use the amplifier in a gain of two or greater.

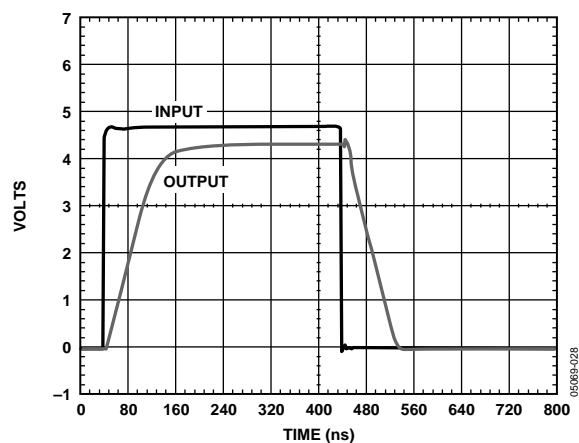

Figure 22. Unity-Gain Input Overdrive Recovery

CAPACITIVE LOAD DRIVE

When driving capacitive loads, many high speed operational amplifiers exhibit peaking in their frequency response. In a gain-of-two circuit, Figure 23 shows that the AD8397 can drive capacitive loads up to 270 pF with only 3 dB of peaking. For amplifiers with more limited capacitive load drive, a small series resistor (R_s) is generally used between the amplifier output and the capacitive load in order to minimize peaking and ensure device stability. Figure 24 shows that the use of a 2.2 Ω series resistor can further extend the capacitive load drive of the AD8397 out to 470 pF, while keeping the frequency response peaking to within 3 dB.

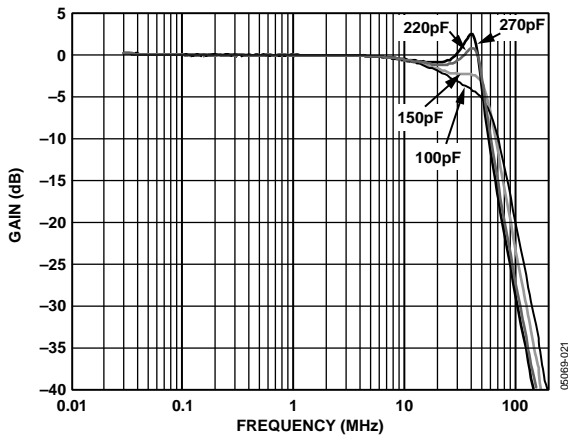

Figure 23. Capacitive Load Peaking Without Series Resistor

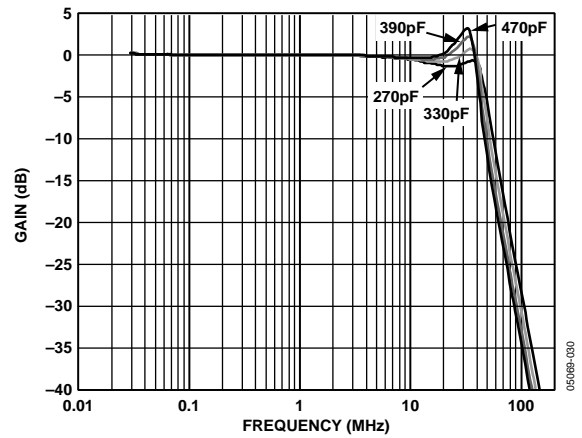
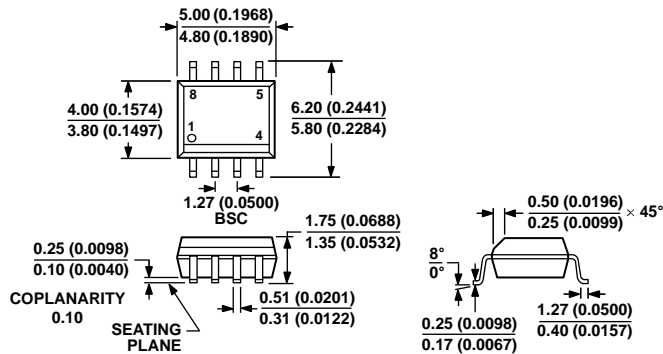

Figure 24. Capacitive Load Peaking with 2.2 Ω Series Resistor

OUTLINE DIMENSIONS



COMPLIANT TO JEDEC STANDARDS MS-012-AA
 CONTROLLING DIMENSIONS ARE IN MILLIMETERS; INCH DIMENSIONS (IN PARENTHESES) ARE ROUNDED-OFF MILLIMETER EQUIVALENTS FOR REFERENCE ONLY AND ARE NOT APPROPRIATE FOR USE IN DESIGN.

012407-A

Figure 25. 8-Lead Standard Small Outline Package [SOIC_N] Narrow Body (R-8)

Dimensions shown in millimeters and (inches)

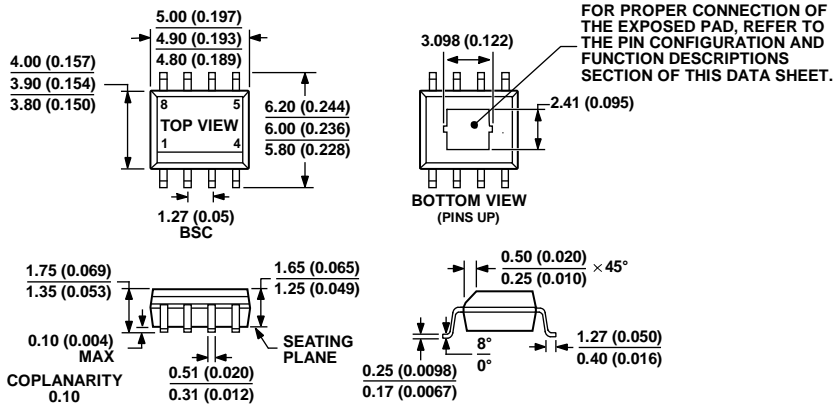

COMPLIANT TO JEDEC STANDARDS MS-012-AA
 CONTROLLING DIMENSIONS ARE IN MILLIMETER; INCH DIMENSIONS (IN PARENTHESES) ARE ROUNDED-OFF MILLIMETER EQUIVALENTS FOR REFERENCE ONLY AND ARE NOT APPROPRIATE FOR USE IN DESIGN.

07-28-2008-A

Figure 26. 8-Lead Standard Small Outline Package with Exposed Pad [SOIC_N_EP] Narrow Body (RD-8-2)

Dimensions shown in millimeters and (inches)

ORDERING GUIDE

Model ¹	Temperature Package	Package Description	Package Outline
AD8397ARZ	-40°C to +85°C	8-Lead SOIC_N	R-8
AD8397ARZ-REEL	-40°C to +85°C	8-Lead SOIC_N	R-8
AD8397ARZ-REEL7	-40°C to +85°C	8-Lead SOIC_N	R-8
AD8397ARDZ	-40°C to +85°C	8-Lead SOIC_N_EP	RD-8-2
AD8397ARDZ-REEL	-40°C to +85°C	8-Lead SOIC_N_EP	RD-8-2
AD8397ARDZ-REEL7	-40°C to +85°C	8-Lead SOIC_N_EP	RD-8-2

¹ Z = RoHS Compliant Part.

AD8397

NOTES

NOTES

AD8397

NOTES