

MSI1769 series

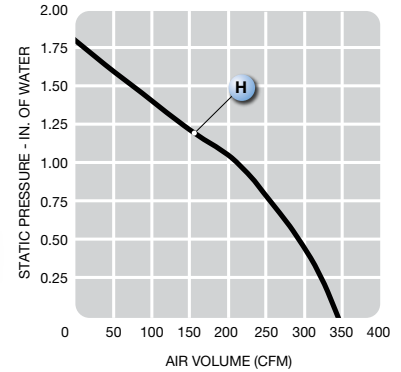
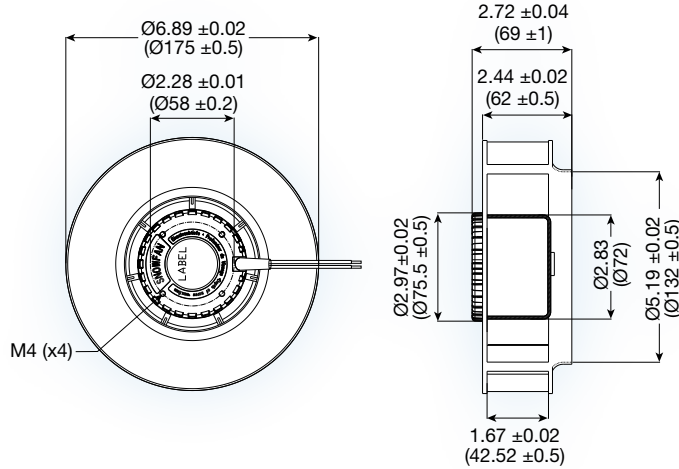

(175 dia. x 69 mm)

6.89 dia. x 2.72 inches

Features: soft start, reverse polarity protection, auto-restart

Operating Voltage: 24 or 48 VDC

Construction: aluminum die cast motor base; UL94V-0 plastic impeller

Bearing option: ball bearing

Motor: brushless DC

Model No.	Rated Voltage VDC	Current A		Speed RPM	Air Volume		Max. Static Pressure (H ₂ O)		Sound Noise dba	Weight g
		24	48		M ³ /Min.	CFM	MM	INCH		
MSI1769H	24/48	4.60	2.30	4,000	9.8	345	45.7	1.80	72	1300

