



LUMILEDS LUXEON® 20mm LENSES AND HOLDERS



OPERATING CONDITIONS

- ▲ 105°C max temperature

MATERIALS/FINISH

- ▲ Lenses are optical grade PMMA acrylic
- ▲ Holders are made of durable polycarbonate

MECHANICAL DIMENSIONS

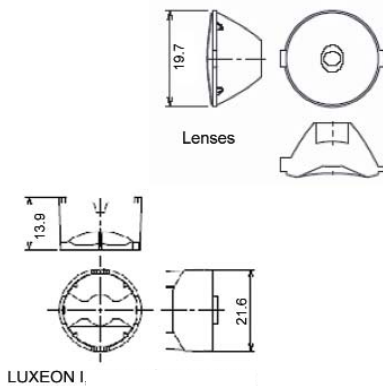

FEATURES / BENEFITS

- ▲ For LUXEON I
- ▲ Available in spot, medium, wide and oval lenses
- ▲ Snap-in optics
- ▲ Greater than 85% efficiency

ORDERING INFORMATION

HOLDERS			
Dialight P/N	Reference P/N	Description	
OHES1WH	OH-ES1-WH	LUXEON I, III, V & Star I - Direct PCB Mount (White)	
OHES1BK	OH-ES1-BK	LUXEON I, III, V & Star I - Direct PCB Mount (Black)	
LENS			
Dialight P/N	Reference P/N	Description	Degree*
OP005	OP-005	Spot Lens	5°
OP015	OP-015	Medium Lens	15°
OP025	OP-025	Wide Lens	25°
OP520	OP-520	Oval Lens	5° X 20°
*All angles refer to half divergence			

PHOTOMETRIC DATA

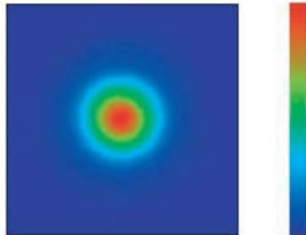

Spot Lens

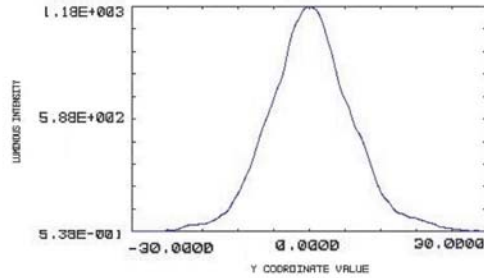

Typical half-angle divergence 5°
when using LUXEON I Cool White

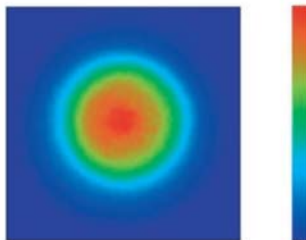

Medium Lens

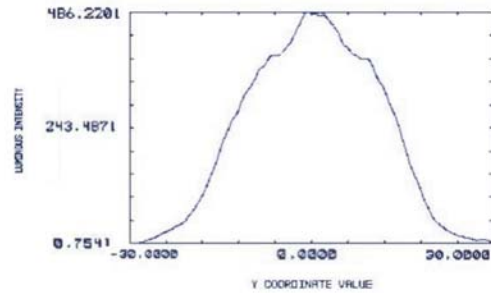

Typical half-angle divergence 15° when
using LUXEON I Cool White

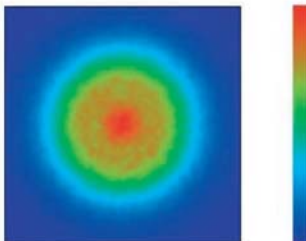

Wide Lens

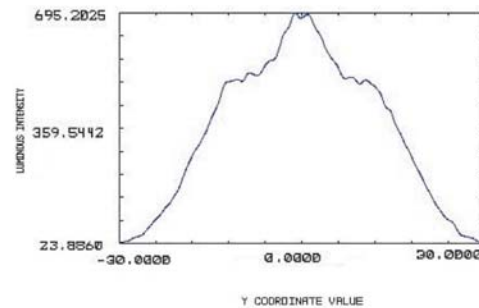

Typical half-angle divergence 25° when
using LUXEON I Cool White

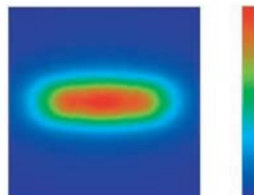

Oval Lens

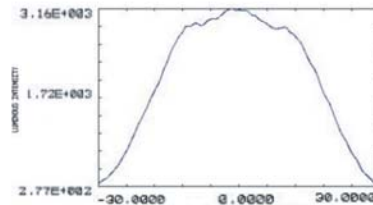

Horizontal

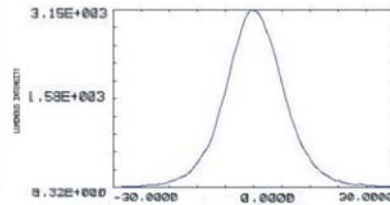

Vertical

Typ. half-angle divergence
5° X 20° LUXEON I Cool White

Dialight reserves the right to make changes at any time in order to supply the best product possible.

The most current version of this document will always be available at:

www.dialight.com/Assets/Brochures_And_Catalogs/Illumination/MDEXLUMLUX.pdf