

NLAS5213

1 Ω R_{ON} DPST and Dual SPST Switches

The NLAS5213A and NLAS5213B are DPST and Dual SPST devices, respectively. They each consist of 2 single throw switches and are both designed for audio applications within portable devices. The NLAS5213A is controlled with a single enable pin while the NLAS5213B has two independent enables.

Both the NLAS5213A and NLAS5213B operate over a wide V_{CC} range, 1.65 V to 4.5 V, and maintain a very low R_{ON} : 1.3 Ω Max @ $V_{CC} = 4.2$ V. Each is available in a choice of two packages: US8 and UDFN8.

Features

- PST and Dual SPST Pinouts
- R_{ON} : 1.3 Ω Max @ $V_{CC} = 4.2$ V
- V_{CC} Range: 1.65 V to 4.5 V
- 8 kV Human Body Model ESD on I/O to GND
- UDFN8 or US8 Packages Available
- These are Pb-Free Devices

Typical Applications

- Mobile Phones
- Portable Devices



ON Semiconductor®

<http://onsemi.com>

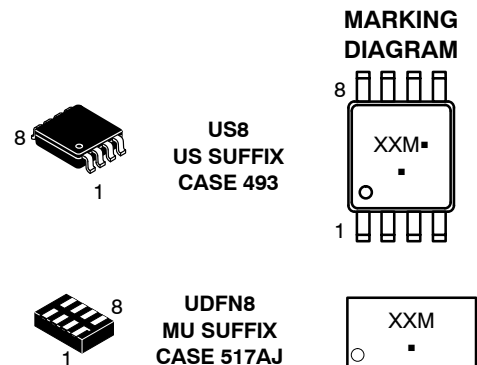

XX = Device Code
M = Date Code
▪ = Pb-Free Package

(Note: Microdot may be in either location)

APPLICATION DIAGRAM

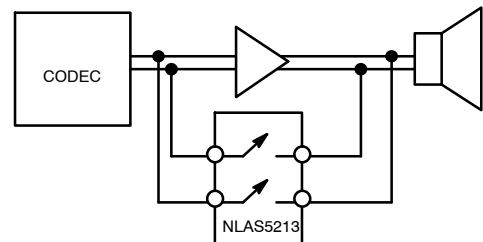

ORDERING INFORMATION

See detailed ordering, marking and shipping information in the package dimensions section on page 9 of this data sheet.

NLAS5213

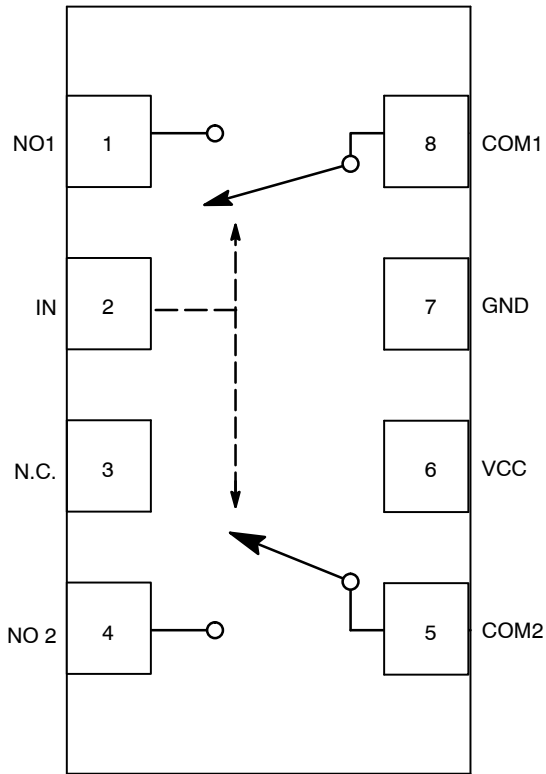

NLAS5213A

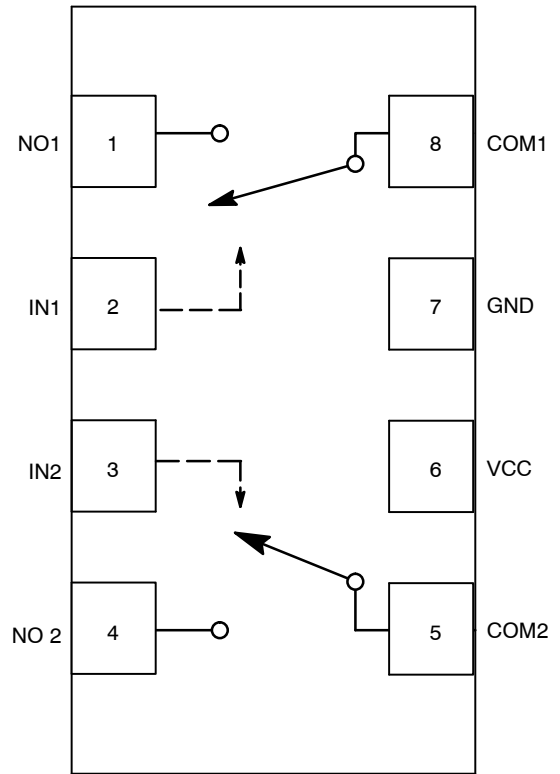

NLAS5213B

Figure 1. Functional Block Diagram Pinouts (UDFN8)

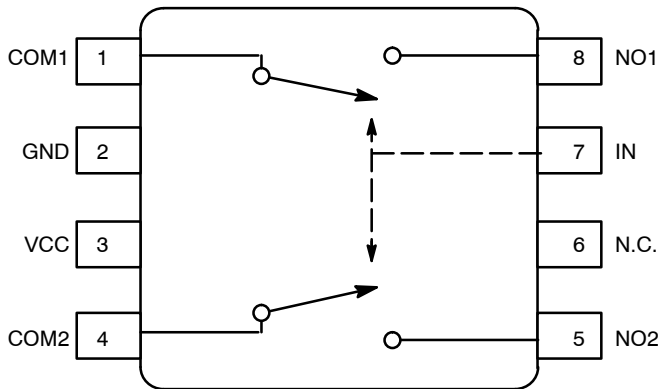

NLAS5213A

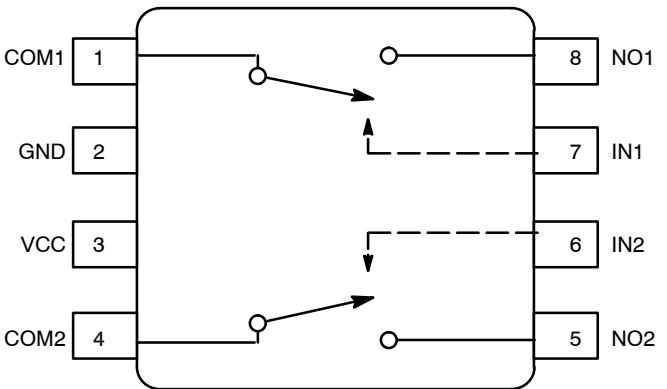

NLAS5213B

Figure 2. Functional Block Diagram Pinouts (US8)

NLAS5213

NLAS5213A

Pin #		Name	Direction	Description
UDFN8	US8			
1	8	NO1	I/O	Normally Open Signal Line of Switch 1
2	7	IN	Input	Control Input
3	6	N.C.	N/A	No Connect
4	5	NO2	I/O	Normally Open Signal Line of Switch 2
5	4	COM2	I/O	Common Signal Line of Switch 2
6	3	V _{CC}	Input	Analog Supply Voltage
7	2	GND	Input	Ground
8	1	COM1	I/O	Common Signal Line of Switch 1

NLAS5213B

Pin #		Name	Direction	Description
UDFN8	US8			
1	8	NO1	I/O	Normally Open Signal Line of Switch 1
2	7	IN1	Input	Control Input of Switch 1
3	6	IN2	Input	Control Input of Switch 2
4	5	NO2	I/O	Normally Open Signal Line of Switch 2
5	4	COM2	I/O	Common Signal Line of Switch 2
6	3	V _{CC}	Input	Analog Supply Voltage
7	2	GND	Input	Ground
8	1	COM1	I/O	Common Signal Line of Switch 1

NLAS5213A FUNCTION TABLE

IN	NO1, NO2
0	OFF
1	ON

NLAS5213B FUNCTION TABLE

IN	NO1, NO2
0	OFF
1	ON

NLAS5213

OPERATING CONDITIONS

MAXIMUM RATINGS

Symbol	Pins	Parameter	Value	Condition	Unit
V _{CC}	V _{CC}	Positive DC Supply Voltage	-0.5 to 5.5		V
V _{IS}	NOx, NCx, COMx	Analog Signal Voltage	-0.5 to V _{CC} + 0.5		V
V _{IN}	IN1, IN2	Control Input Voltage	-0.5 to 5.5		V
I _{CC}	V _{CC}	Positive DC Supply Current	50		mA
I _{IS_CON}	NOx, NCx, COMx	Analog Signal Continues Current	±300	Closed Switch	mA
I _{IS_PK}	NOx, NCx, COMx	Analog Signal Peak Current	±500	10% Duty Cycle	mA
I _{IN}	IN	Control Input Current	±20		mA
T _{STG}		Storage Temperature Range	-65 to 150		°C

Stresses exceeding Maximum Ratings may damage the device. Maximum Ratings are stress ratings only. Functional operation above the Recommended Operating Conditions is not implied. Extended exposure to stresses above the Recommended Operating Conditions may affect device reliability.

RECOMMENDED OPERATING CONDITIONS*

Symbol	Pins	Parameter	Value	Condition	Unit
V _{CC}	V _{CC}	Positive DC Supply Voltage	1.65 to 4.5		V
V _{IS}	NOx, NCx, COMx	Analog Signal Voltage	0 to V _{CC}		V
V _{IN}	IN1, IN2	Control Input Voltage	0 to V _{CC}		V
T _A		Operating Temperature Range	-40 to 85		°C

Minimum and maximum values are guaranteed through test or design across the **Recommended Operating Conditions**, where applicable. Typical values are listed for guidance only and are based on the particular conditions listed for each section, where applicable. These conditions are valid for all values found in the characteristics tables unless otherwise specified in the test conditions.

ESD PROTECTION

Symbol	Parameter	Value	Unit
ESD	Human Body Model I/O to GND All Pins	8.0 4.0	kV

DC ELECTRICAL CHARACTERISTICS

CONTROL INPUT (Typical: T = 25°C, V_{CC} = 3.3 V)

Symbol	Pins	Parameter	Test Conditions	V _{CC} (V)	-40°C to +85°C			Unit
					Min	Typ	Max	
V _{IH}	OE	Control Input HIGH Voltage		2.7 3.3 4.2	1.4 1.7 2.3	-	-	V
V _{IL}	OE	Control Input LOW Voltage		2.7 3.3 4.2	-	-	0.5 0.5 0.8	V
I _{IN}	OE	Control Input Leakage Current	0 ≤ V _{IS} ≤ V _{CC}	1.65 - 4.5	-	-	±1.0	μA

NLAS5213

SUPPLY CURRENT AND LEAKAGE (Typical: T = 25°C, V_{CC} = 3.3 V)

Symbol	Pins	Parameter	Test Conditions	V _{CC} (V)	-40°C to +85°C			Unit
					Min	Typ	Max	
I _{CC}	V _{CC}	Quiescent Supply Current	V _{IS} = V _{CC} or GND; I _D = 0 A	1.65 – 4.5	–	–	1.0	μA
I _{CC(T)}	V _{CC}	Increase in I _{CC} per Control Voltage	V _{IN} = 2.6 V	3.6	–	–	10.0	μA
I _{OZ}		OFF State Leakage	0 ≤ V _{IS} ≤ V _{CC}	1.65 – 4.5	–	–	±1.0	μA
I _{OFF}	D+, D–	Power OFF Leakage Current	0 ≤ V _{IS} ≤ V _{CC}	0	–	–	±1.0	μA

ON RESISTANCE (Typical: T = 25°C, V_{CC} = 3.3 V)

Symbol	Pins	Parameter	Test Conditions	V _{CC} (V)	-40°C to +85°C			Unit
					Min	Typ	Max	
R _{ON}		On-Resistance	I _{ON} = –100 mA V _{IS} = 0 to V _{CC}	2.7 3.3 4.2	–		2.0 1.4 1.3	Ω
R _{FLAT}		On-Resistance Flatness	I _{ON} = –100 mA V _{IS} = 0 to V _{CC}	2.7 3.3 4.2	–	0.32 0.35 0.37	–	Ω
ΔR _{ON}		On-Resistance Matching	I _{ON} = –100 mA V _{IS} = 0 to V _{CC}	2.7 3.3 4.2	–	0.16 0.16 0.15	–	Ω

AC ELECTRICAL CHARACTERISTICS

TIMING/FREQUENCY (Typical: T = 25°C, V_{CC} = 3.3 V, R_L = 50 Ω, C_L = 5 pF, f = 1 MHz)

Symbol	Pins	Parameter	Test Conditions	V _{CC} (V)	-40°C to +85°C			Unit
					Min	Typ	Max	
t _{ON}	Closed to Open	Turn-ON Time		1.65 – 4.5	–	20	–	ns
t _{OFF}	Open to Closed	Turn-OFF Time		1.65 – 4.5	–	15	–	ns
BW		–3 dB Bandwidth	C _L = 5 pF	1.65 – 4.5	–	496	–	MHz

ISOLATION (Typical: T = 25°C, V_{CC} = 3.3 V, R_L = 50 Ω, C_L = 5 pF, f = 1 MHz)

Symbol	Pins	Parameter	Test Conditions	V _{CC} (V)	-40°C to +85°C			Unit
					Min	Typ	Max	
O _{IRR}	Open	OFF-Isolation		1.65 – 4.5	–	–57	–	dB
X _{TALK}	HSD+, HSD–	Non-Adjacent Channel Crosstalk		1.65 – 4.5	–	–97	–	dB

CAPACITANCE (Typical: T = 25°C, V_{CC} = 3.3 V, R_L = 50 Ω, C_L = 5 pF, f = 1 MHz)

Symbol	Pins	Parameter	Test Conditions	-40°C to +85°C			Unit
				Min	Typ	Max	
C _{IN}	OE	Control Pin Input Capacitance	V _{CC} = 0 V	–	8.5	–	pF
C _{ON}	HSD+, to D+	ON Capacitance	V _{IN} = 0 V	–	32	–	pF
C _{OFF}	HSD+, HSD–	OFF Capacitance	V _{IS} = 3.3 V; V _{IN} = 3.3 V	–	19	–	pF

NLAS5213

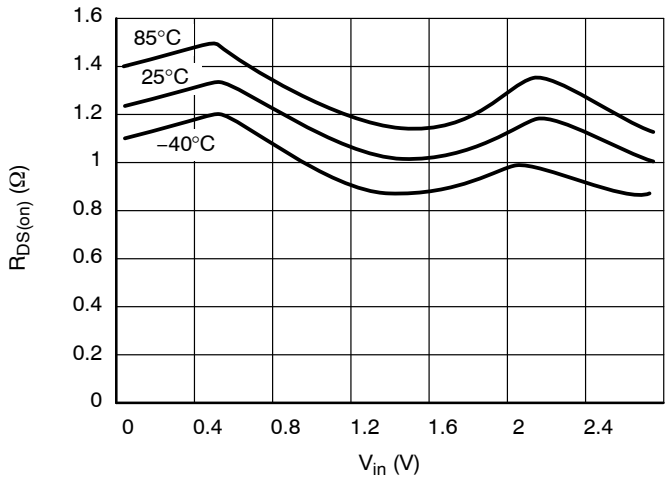

Figure 3. R_{ON} @ $V_{CC} = 2.7$ V

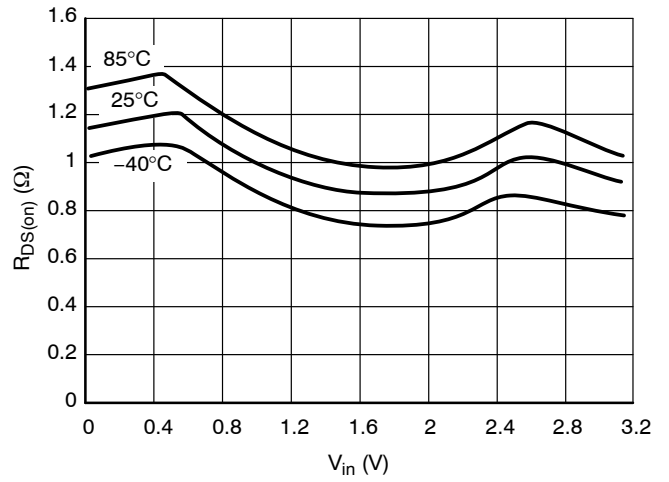

Figure 4. R_{ON} @ $V_{CC} = 3.3$ V

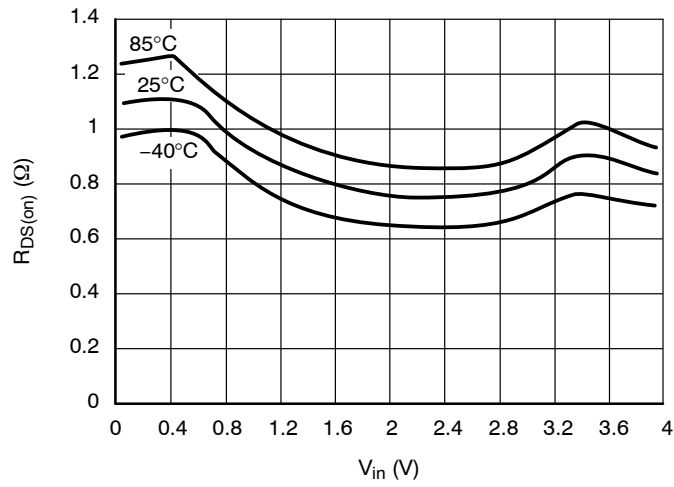

Figure 5. R_{ON} @ $V_{CC} = 4.2$ V

NLAS5213

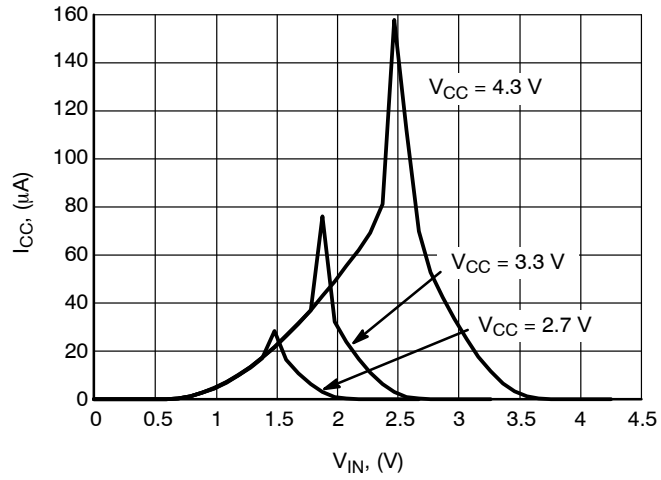

Figure 6. I_{CC} vs. V_{IN}

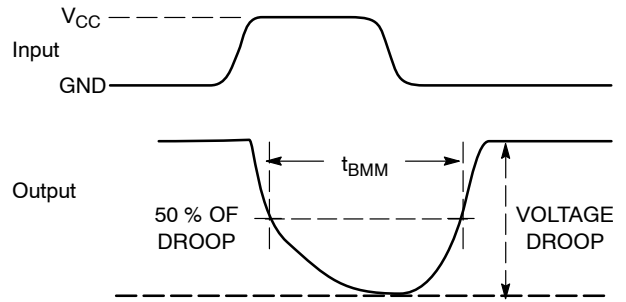
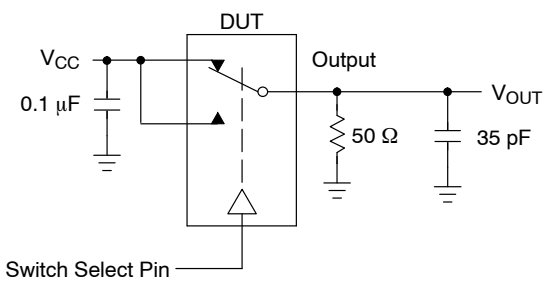

Figure 7. t_{BMM} (Time Break-Before-Make)

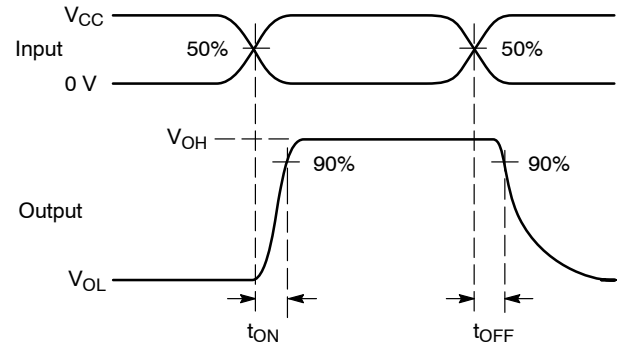
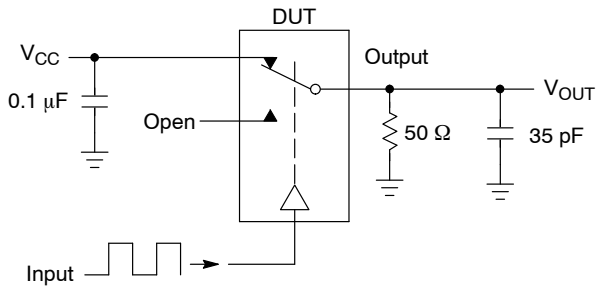

Figure 8. t_{ON}/t_{OFF}

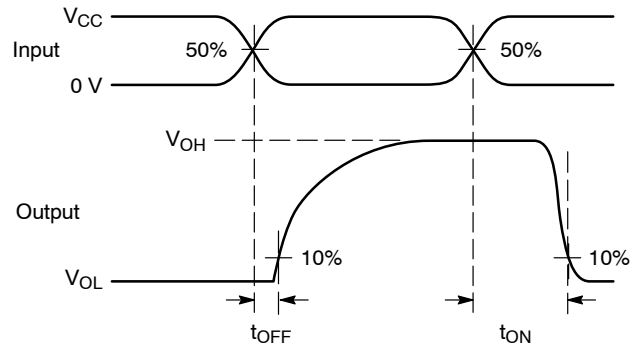
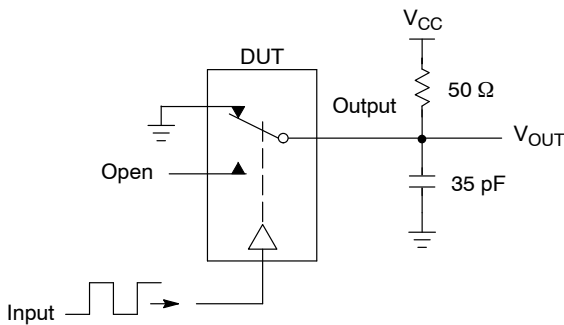
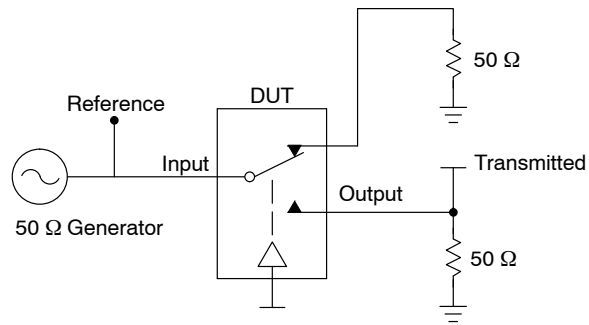

Figure 9. t_{ON}/t_{OFF}

NLAS5213



Channel switch control/s test socket is normalized. Off isolation is measured across an off channel. On loss is the bandwidth of an On switch. V_{ISO} , Bandwidth and V_{ONL} are independent of the input signal direction.

$$V_{ISO} = \text{Off Channel Isolation} = 20 \text{ Log} \left(\frac{V_{OUT}}{V_{IN}} \right) \text{ for } V_{IN} \text{ at } 100 \text{ kHz}$$

$$V_{ONL} = \text{On Channel Loss} = 20 \text{ Log} \left(\frac{V_{OUT}}{V_{IN}} \right) \text{ for } V_{IN} \text{ at } 100 \text{ kHz to } 50 \text{ MHz}$$

Bandwidth (BW) = the frequency 3 dB below V_{ONL}

V_{CT} = Use V_{ISO} setup and test to all other switch analog input/outputs terminated with 50 Ω

Figure 10. Off Channel Isolation/On Channel Loss (BW)/Crosstalk (On Channel to Off Channel)/ V_{ONL}

NLAS5213

DEVICE ORDERING INFORMATION

Device	Marking	Package Type	Shipping [†]
NLAS5213AUSG	VD	US8 (Pb-Free)	3,000 / Tape & Reel
NLAS5213AMUTAG	VD	UDFN8 (Pb-Free)	3,000 / Tape & Reel
NLAS5213BUSG	VE	US8 (Pb-Free)	3,000 / Tape & Reel
NLAS5213BMUTAG	VE	UDFN8 (Pb-Free)	3,000 / Tape & Reel

[†]For information on tape and reel specifications, including part orientation and tape sizes, please refer to our Tape and Reel Packaging Specifications Brochure, BRD8011/D.

NLAS5213

PACKAGE DIMENSIONS

US8
CASE 493-02
ISSUE B

NOTES:

1. DIMENSIONING AND TOLERANCING PER ANSI Y14.5M, 1982.
2. CONTROLLING DIMENSION: MILLIMETERS.
3. DIMENSION "A" DOES NOT INCLUDE MOLD FLASH, PROTRUSION OR GATE BURR. MOLD FLASH, PROTRUSION AND GATE BURR SHALL NOT EXCEED 0.140 MM (0.0055") PER SIDE.
4. DIMENSION "B" DOES NOT INCLUDE INTER-LEAD FLASH OR PROTRUSION. INTER-LEAD FLASH AND PROTRUSION SHALL NOT EXCEED 0.140 (0.0055") PER SIDE.
5. LEAD FINISH IS SOLDER PLATING WITH THICKNESS OF 0.0076-0.0203 MM. (300-800 Å).
6. ALL TOLERANCE UNLESS OTHERWISE SPECIFIED ±0.0508 (0.002").

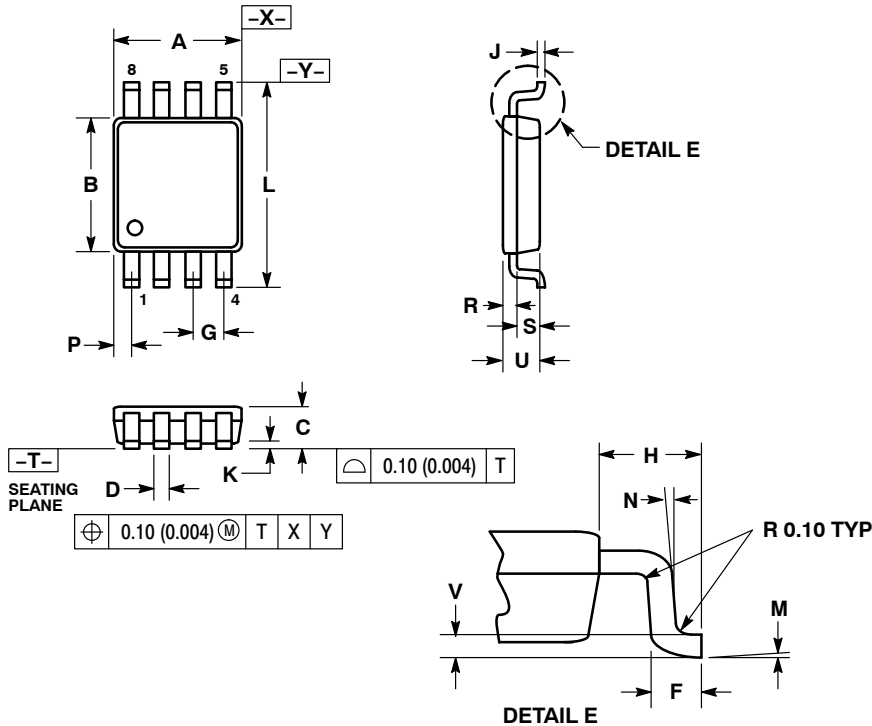

SOLDERING FOOTPRINT*

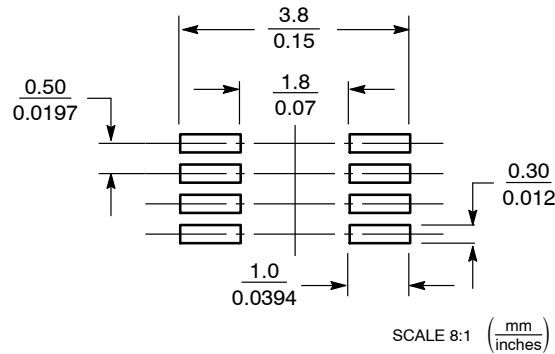

*For additional information on our Pb-Free strategy and soldering details, please download the ON Semiconductor Soldering and Mounting Techniques Reference Manual, SOLDERRM/D.

NLAS5213

PACKAGE DIMENSIONS

UDFN8 1.8x1.2, 0.4P
CASE 517AJ-01
ISSUE 0

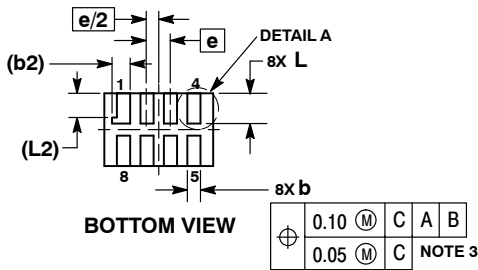
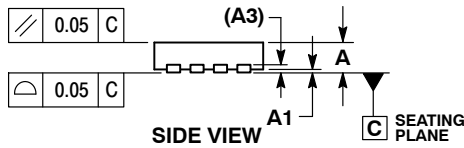
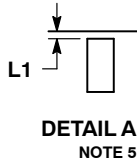
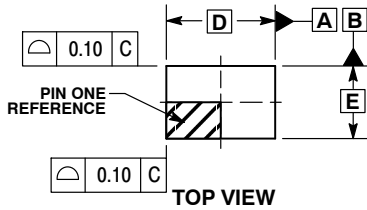

NOTES:

1. DIMENSIONING AND TOLERANCING PER ASME Y14.5M, 1994.
2. CONTROLLING DIMENSION: MILLIMETERS.
3. DIMENSION b APPLIES TO PLATED TERMINAL AND IS MEASURED BETWEEN 0.15 AND 0.30 mm FROM TERMINAL TIP.
4. MOLD FLASH ALLOWED ON TERMINALS ALONG EDGE OF PACKAGE. FLASH MAY NOT EXCEED 0.03 ONTO BOTTOM SURFACE OF TERMINALS.
5. DETAIL A SHOWS OPTIONAL CONSTRUCTION FOR TERMINALS.

MILLIMETERS		
DIM	MIN	MAX
A	0.45	0.55
A1	0.00	0.05
A3	0.127	REF
b	0.15	0.25
b2	0.30	REF
D	1.80	BSC
E	1.20	BSC
e	0.40	BSC
L	0.45	0.55
L1	0.00	0.03
L2	0.40	REF

SOLDERING FOOTPRINT*

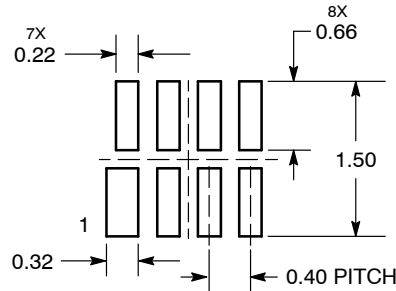

DIMENSIONS: MILLIMETERS

*For additional information on our Pb-Free strategy and soldering details, please download the ON Semiconductor Soldering and Mounting Techniques Reference Manual, SOLDERRM/D.

ON Semiconductor and are registered trademarks of Semiconductor Components Industries, LLC (SCILLC). SCILLC reserves the right to make changes without further notice to any products herein. SCILLC makes no warranty, representation or guarantee regarding the suitability of its products for any particular purpose, nor does SCILLC assume any liability arising out of the application or use of any product or circuit, and specifically disclaims any and all liability, including without limitation special, consequential or incidental damages. "Typical" parameters which may be provided in SCILLC data sheets and/or specifications can and do vary in different applications and actual performance may vary over time. All operating parameters, including "Typicals" must be validated for each customer application by customer's technical experts. SCILLC does not convey any license under its patent rights nor the rights of others. SCILLC products are not designed, intended, or authorized for use as components in systems intended for surgical implant into the body, or other applications intended to support or sustain life, or for any other application in which the failure of the SCILLC product could create a situation where personal injury or death may occur. Should Buyer purchase or use SCILLC products for any such unintended or unauthorized application, Buyer shall indemnify and hold SCILLC and its officers, employees, subsidiaries, affiliates, and distributors harmless against all claims, costs, damages, and expenses, and reasonable attorney fees arising out of, directly or indirectly, any claim of personal injury or death associated with such unintended or unauthorized use, even if such claim alleges that SCILLC was negligent regarding the design or manufacture of the part. SCILLC is an Equal Opportunity/Affirmative Action Employer. This literature is subject to all applicable copyright laws and is not for resale in any manner.

PUBLICATION ORDERING INFORMATION

LITERATURE FULFILLMENT:
Literature Distribution Center for ON Semiconductor
P.O. Box 5163, Denver, Colorado 80217 USA
Phone: 303-675-2175 or 800-344-3860 Toll Free USA/Canada
Fax: 303-675-2176 or 800-344-3867 Toll Free USA/Canada
Email: orderlit@onsemi.com

N. American Technical Support: 800-282-9855 Toll Free USA/Canada
Europe, Middle East and Africa Technical Support:
Phone: 421 33 790 2910
Japan Customer Focus Center
Phone: 81-3-5773-3850

ON Semiconductor Website: www.onsemi.com
Order Literature: <http://www.onsemi.com/orderlit>

For additional information, please contact your local Sales Representative