

DO NOT SCALE FROM THIS PRINT

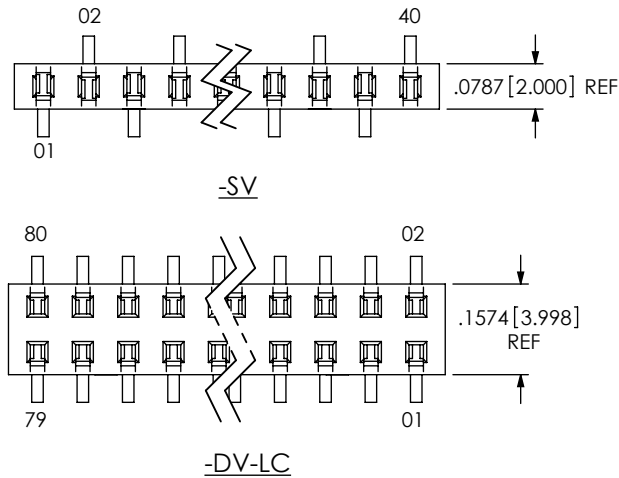

MMS-1XX-02-XXX-XX-XX-XXX

No OF POSITIONS
-02 THRU -40
(PER ROW)

LEAD STYLE
-02: SURFACE MOUNT

POLARIZING OPTION
-XXX INDICATES POSITION No
(USE PK-07-N)

OPTION

- PLATING SPECIFICATION
- S: 30μ" SELECTIVE GOLD IN CONTACT AREA, MATTE TIN TAIL
 - L: 10μ" SELECTIVE GOLD IN CONTACT AREA, MATTE TIN TAIL
 - F: 3μ" SELECTIVE GOLD IN CONTACT AREA, MATTE TIN TAIL
 - ** -T: MATTE TIN OVER ENTIRE CONTACT
 - LTL: 10μ" SELECTIVE GOLD IN CONTACT AREA, TIN LEAD (90/10 ±5%) TAIL
 - SM: 30μ" SELECTIVE GOLD IN CONTACT AREA, MATTE TIN TAIL
 - LM: 10μ" SELECTIVE GOLD IN CONTACT AREA, MATTE TIN TAIL
 - FM: 3μ" SELECTIVE GOLD IN CONTACT AREA, MATTE TIN TAIL
 - ** -TM: MATTE TIN OVER ENTIRE CONTACT
 - H: 30μ" GOLD IN CONTACT AREA, 3μ" GOLD ON TAIL
- OPTION
- LC: LOCKING CLIP (NOT AVAILABLE ON -SV) (USE LC-06-TM, SEE FIG 1, FIG 2 & 3, SHT 2 & NOTES 6 & 7)
 - P: PICK & PLACE PAD (ONLY AVAILABLE ON -SV & -DV, 4 POS MIN) (-SV: USE PPP-09; -DV: USE PPP-03; SEE FIG 5, SHT 2)
 - M: METAL PICK & PLACE PAD (ONLY AVAILABLE ON -DV) (USE LMP-03, SEE FIG 7, SHT 3)
 - A: MOLDED ALIGNMENT PIN (AVAILABLE ON -DV ONLY) (USE MMS-XX-D-VXX, SEE FIG 4, SHT 3)
 - K: POLYIMIDE FILM PAD (AVAILABLE ON 3 POS MIN, FOR -SV USE K-DOT-.118-.219-.005, FOR -DV USE K-DOT-.217-.313-.005) (SEE FIG 6, SHT 3)
 - TR: TAPE & REEL PACKAGING (SEE FIG 8, SHT 4) (AVAILABLE ON 2-36 POS ONLY)
- ENTRY/ROW SPECIFICATION
- SH: SINGLE ROW, HORIZONTAL ENTRY
 - DH: DOUBLE ROW, HORIZONTAL ENTRY
 - SV: SINGLE ROW, VERTICAL (TOP) ENTRY
 - DV: DOUBLE ROW, VERTICAL (TOP) ENTRY

** = AVAILABLE TO EXISTING CUSTOMERS ONLY

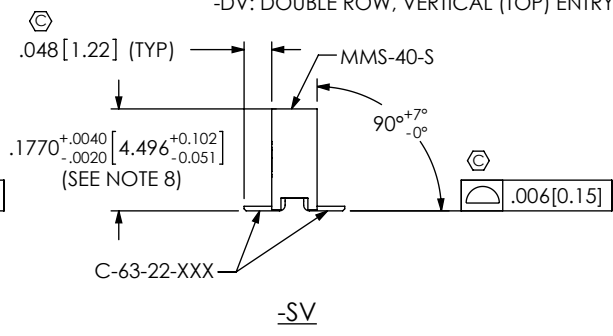
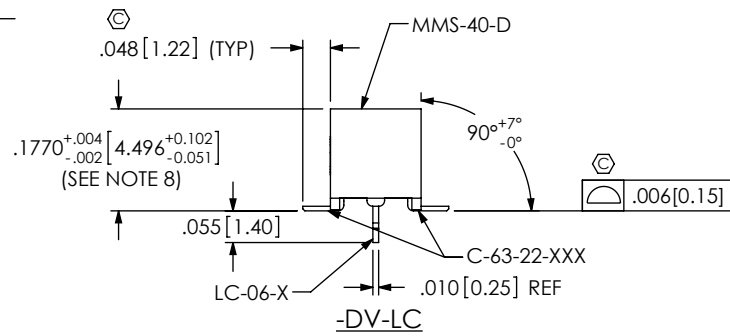
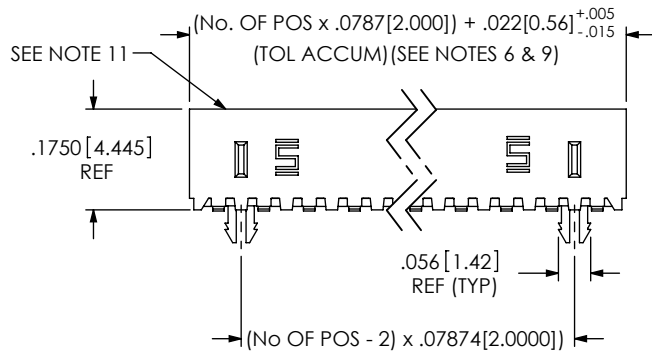
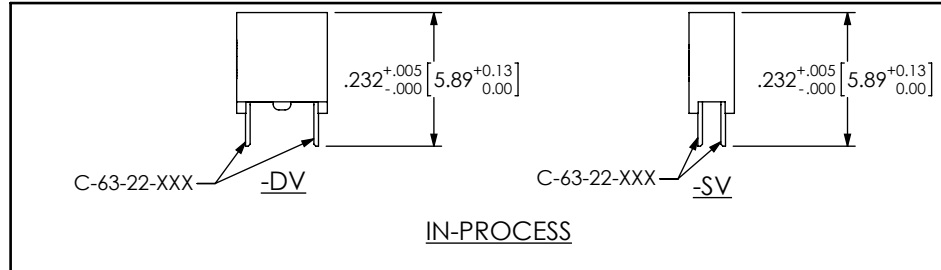

FIG 1
MMS-140-02-XXX-XV-LC SHOWN

- NOTES:
1. Ⓢ REPRESENTS A CRITICAL DIMENSION.
 2. MAXIMUM ALLOWABLE SWAY: 2° IN EITHER DIRECTION
 3. MAXIMUM BURR ALLOWANCE: .003 [0.08]
 4. MAXIMUM CUT FLASH: .020 [0.51]
 5. MINIMUM RETENTION FORCE: SINGLE ROW: .5 LB, DOUBLE ROW: 1 LB
 6. CUT BODIES FROM MMS-40-D OR MMS-40-S FOR ALL STYLES EXCEPT -LC. FOR -LC, USE POSITIONALIZED BODIES. 3 POSITION -DV-LC PARTS WILL HAVE 1 LOCKING CLIP.
 7. DUE TO THE HIGH AMOUNT OF INSERTION FORCE NEEDED, THE -LC OPTION IS NOT COMPATIBLE WITH AUTO PLACEMENT. SAMTEC RECOMMENDS MANUAL PLACEMENT FOR ALL ASSEMBLIES WITH THE -LC OPTION.
 8. THIS DIMENSION TO BE MEASURED AT BEND.
 9. FOR -SV LEAD STYLE, EVEN POSITION CUTS LOSE 2 POSITIONS PER CUT; ODD POSITION CUTS LOSE 1 POSITION PER CUT.
 10. LEAD STYLE -02-SH, POSITIONS 2 THRU 4 TO BE PACKAGED IN BOXES. ALL OTHER ROW SPECIFICATIONS SHOULD BE TUBED ACCORDING TO TABLE 2, REGARDLESS OF POSITION.
 11. PK-07-N TO BE INSERTED FROM THIS SIDE.



<p>UNLESS OTHERWISE SPECIFIED, DIMENSIONS ARE IN INCHES.</p> <p>TOLERANCES ARE:</p> <table border="0"> <tr> <td>DECIMALS</td> <td>ANGLES</td> </tr> <tr> <td>.XX: ±.01 [.3]</td> <td>2°</td> </tr> <tr> <td>.XXX: ±.005 [.13]</td> <td></td> </tr> <tr> <td>.XXXX: ±.0020 [.051]</td> <td></td> </tr> </table>	DECIMALS	ANGLES	.XX: ±.01 [.3]	2°	.XXX: ±.005 [.13]		.XXXX: ±.0020 [.051]		<p>PROPRIETARY NOTE</p> <p>THIS DOCUMENT CONTAINS CONFIDENTIAL AND PROPRIETARY INFORMATION AND ALL DESIGN, MANUFACTURING, REPRODUCTION, USE, PATENT RIGHTS AND SALES RIGHTS ARE EXPRESSLY RESERVED BY SAMTEC, INC. THIS DOCUMENT SHALL NOT BE DISCLOSED, IN WHOLE OR PART, TO ANY UNAUTHORIZED PERSON OR ENTITY NOR REPRODUCED, TRANSFERRED OR INCORPORATED IN ANY OTHER PROJECT IN ANY MANNER WITHOUT THE EXPRESS WRITTEN CONSENT OF SAMTEC, INC.</p>	<p>520 PARK EAST BLVD, NEW ALBANY, IN 47150 PHONE: 812-944-6733 FAX: 812-948-5047 e-Mail info@SAMTEC.com code 55322</p>
	DECIMALS	ANGLES								
.XX: ±.01 [.3]	2°									
.XXX: ±.005 [.13]										
.XXXX: ±.0020 [.051]										
<p>MATERIAL: DO NOT SCALE DRAWING SHEET SCALE: 3:1</p> <p>INSULATOR: VECTRA E130I, COLOR: BLACK CONTACT: PHOS BRONZE</p>	<p>DESCRIPTION: 2mm SURFACE MOUNT BOX CONNECTOR STRIP ASM</p> <p>DWG. NO. MMS-1XX-02-XXX-XX-XX-XXX</p> <p>BY: BRATCHER 04/01/1994 SHEET 1 OF 4</p>									

REVISION CP

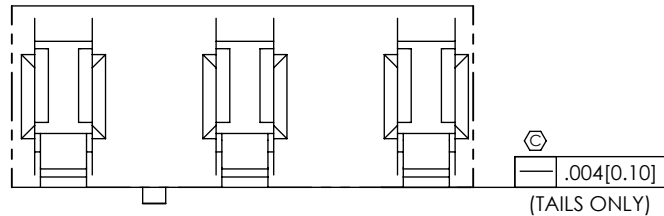
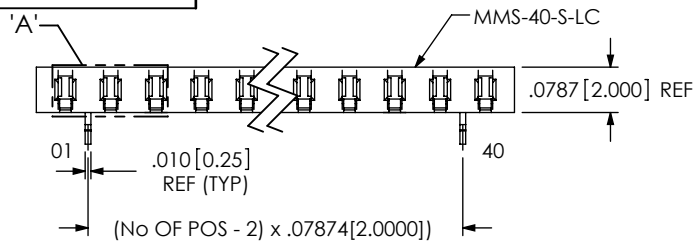

DETAIL 'A'
SCALE 12 : 1

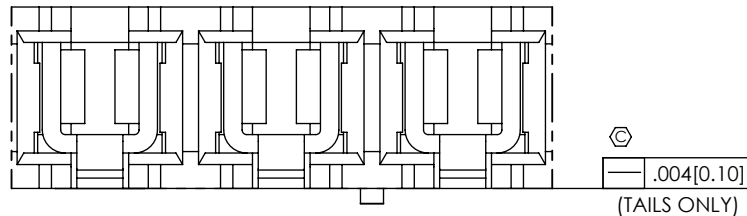
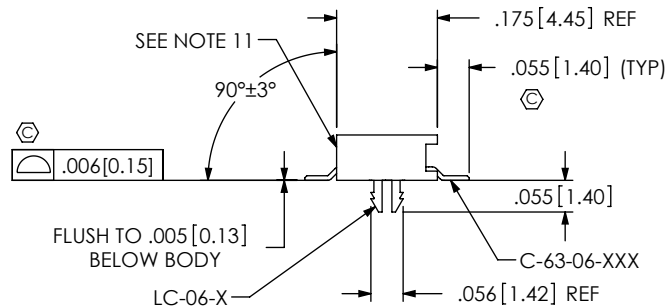

DETAIL 'B'
SCALE 12 : 1

FIG 2
MMS-140-02-XXX-SH-LC SHOWN

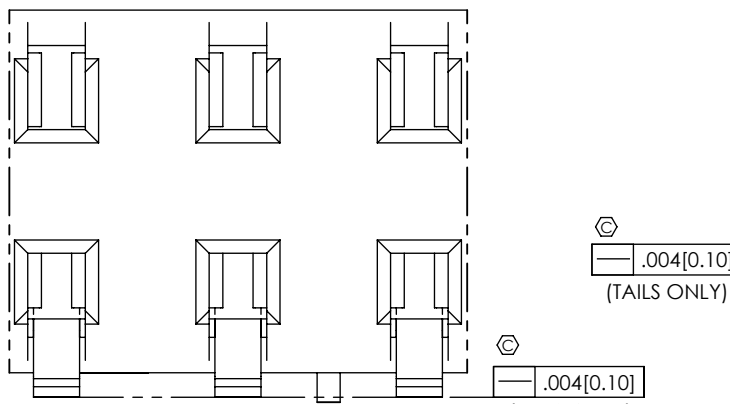
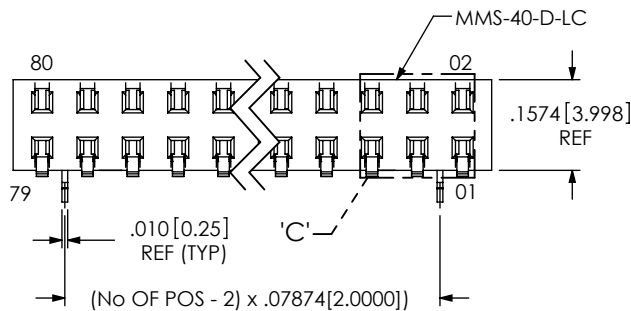
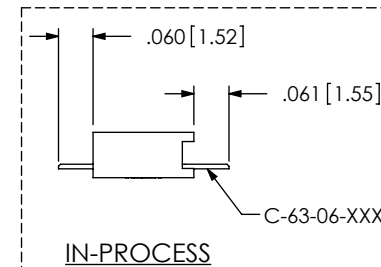
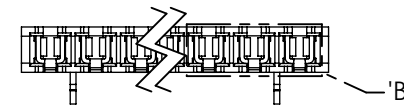

DETAIL 'C'
SCALE 12 : 1

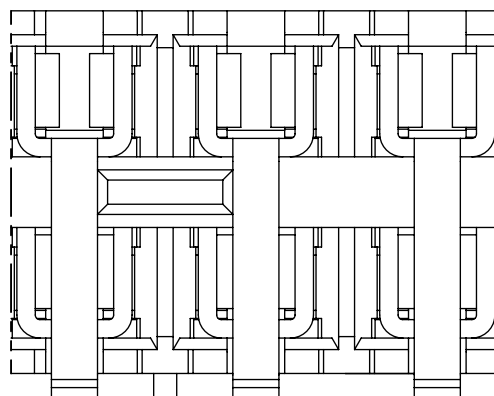
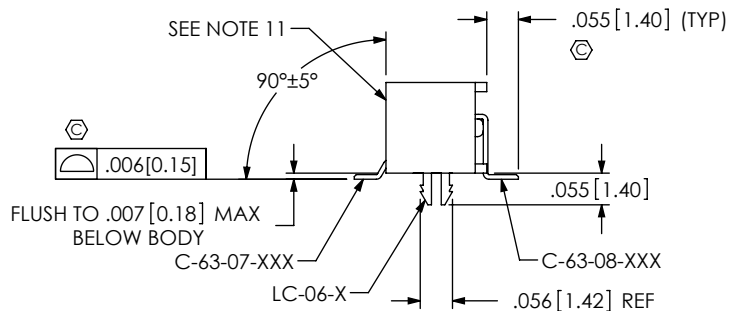

DETAIL 'D'
SCALE 12 : 1

FIG 3
MMS-140-02-XXX-DH-LC SHOWN

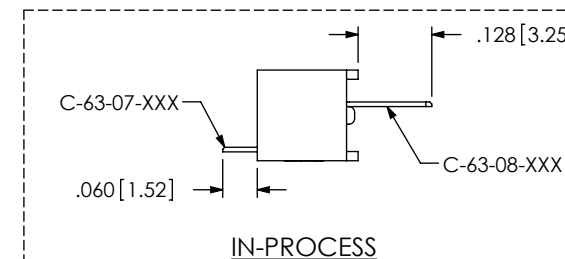
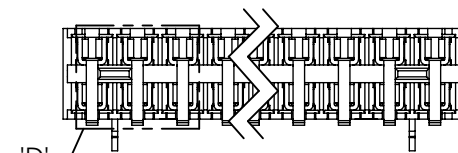

PROPRIETARY NOTE
THIS DOCUMENT CONTAINS CONFIDENTIAL AND PROPRIETARY INFORMATION AND ALL DESIGN, MANUFACTURING, REPRODUCTION, USE, PATENT RIGHTS AND SALES RIGHTS ARE EXPRESSLY RESERVED BY SAMTEC, INC. THIS DOCUMENT SHALL NOT BE DISCLOSED, IN WHOLE OR PART, TO ANY UNAUTHORIZED PERSON OR ENTITY NOR REPRODUCED, TRANSFERRED OR INCORPORATED IN ANY OTHER PROJECT IN ANY MANNER WITHOUT THE EXPRESS WRITTEN CONSENT OF SAMTEC, INC.



520 PARK EAST BLVD, NEW ALBANY, IN 47150
PHONE: 812-944-6733 FAX: 812-948-5047
e-Mail info@SAMTEC.com code 55322

DO NOT SCALE DRAWING
SHEET SCALE: 3:1

DESCRIPTION:
2mm SURFACE MOUNT BOX CONNECTOR STRIP ASM

DWG. NO.
MMS-1XX-02-XXX-XX-XX-XXX

BY: BRATCHER 04/01/1994 SHEET 2 OF 4

"R" = USED MEASURED DIMENSION
 "S" = ("R" - .118[3.00]) / 2
 *DIM WILL BE .187[4.75] IF POLARIZATION KEY IS UNDER PAD.

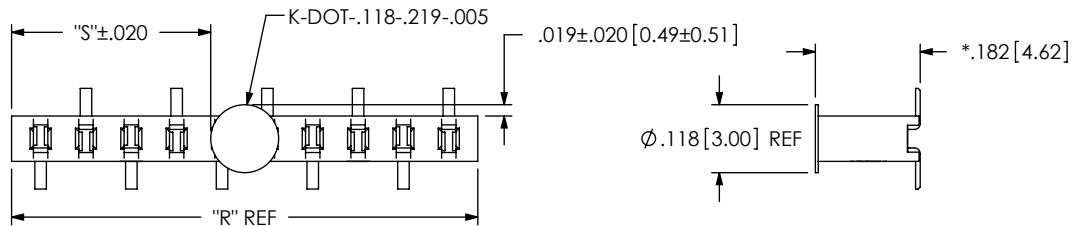

-SV-K

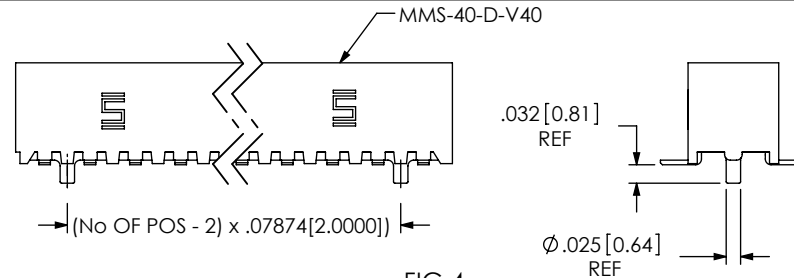
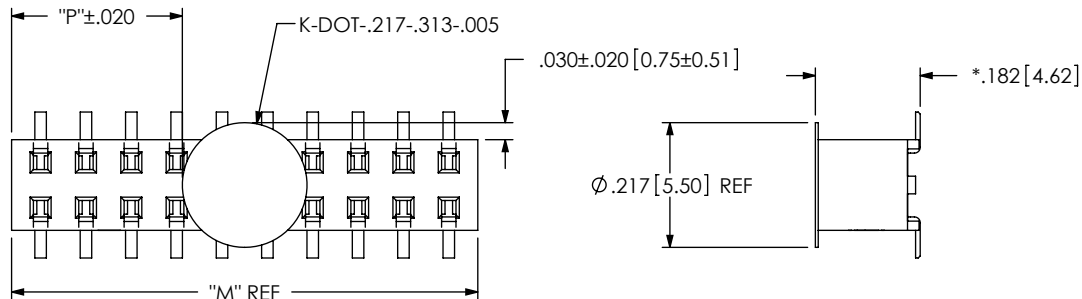

FIG 4
 -A: MOLDED ALIGNMENT PIN
 ONLY AVAILABLE ON -DV
 (MMS-140-02-XXX-DV-A SHOWN)
 (DIFFERENT AS SHOWN, OTHERWISE SAME AS FIG 1)

"M" = USED MEASURED DIMENSION
 "P" = ("M" - .2165[5.50]) / 2
 *DIM WILL BE .187[4.75] IF POLARIZATION KEY IS UNDER PAD.



-DV-K

FIG 6
 -K: POLYIMIDE FILM PAD
 ONLY AVAILABLE ON -SV & -DV
 (MMS-140-02-XXX-XV-K SHOWN)
 (DIFFERENT AS SHOWN, OTHERWISE SAME AS FIG 1)

"L" = (No OF POSITIONS x .07874 [2.0000]) + .022 [0.56]

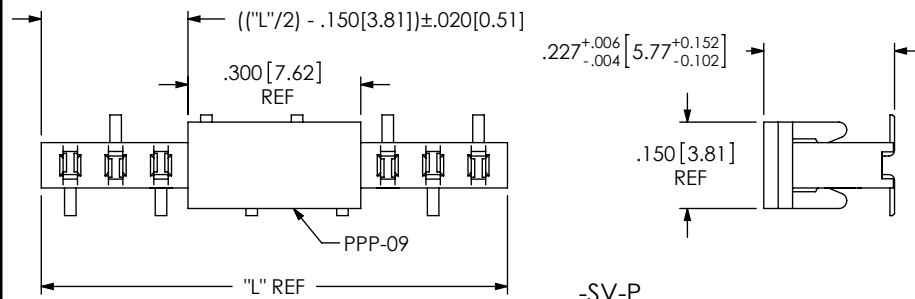

-SV-P

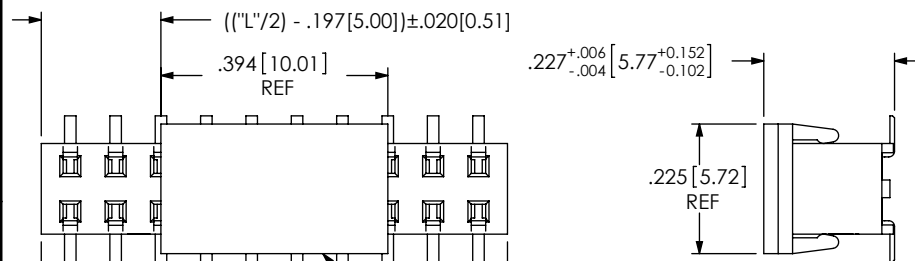

-DV-P

FIG 5
 -P: PICK & PLACE PAD
 ONLY AVAILABLE ON -SV & -DV
 (MMS-140-02-XXX-XV-P SHOWN)
 (DIFFERENT AS SHOWN, OTHERWISE SAME AS FIG 1)

"L" = (No OF POSITIONS x .07874 [2.0000]) + .022 [0.56]

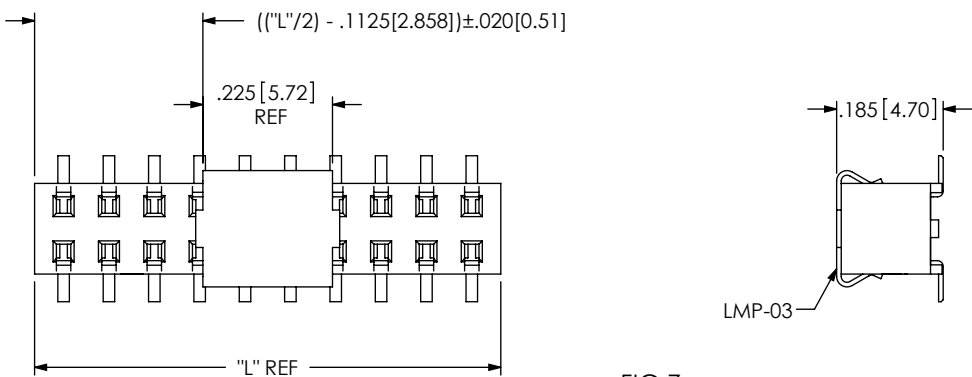

FIG 7

-M: METAL PICK & PLACE PAD
 ONLY AVAILABLE ON -DV
 (MMS-140-02-XXX-DV-M SHOWN)
 (DIFFERENT AS SHOWN, OTHERWISE SAME AS FIG 1)

PROPRIETARY NOTE
 THIS DOCUMENT CONTAINS CONFIDENTIAL AND PROPRIETARY INFORMATION AND ALL DESIGN, MANUFACTURING, REPRODUCTION, USE, PATENT RIGHTS AND SALES RIGHTS ARE EXPRESSLY RESERVED BY SAMTEC, INC. THIS DOCUMENT SHALL NOT BE DISCLOSED, IN WHOLE OR PART, TO ANY UNAUTHORIZED PERSON OR ENTITY NOR REPRODUCED, TRANSFERRED OR INCORPORATED IN ANY OTHER PROJECT IN ANY MANNER WITHOUT THE EXPRESS WRITTEN CONSENT OF SAMTEC, INC.



520 PARK EAST BLVD, NEW ALBANY, IN 47150
 PHONE: 812-944-6733 FAX: 812-948-5047
 e-Mail info@SAMTEC.com code 55322

DO NOT SCALE DRAWING

SHEET SCALE: 3:1

DESCRIPTION:
 2mm SURFACE MOUNT BOX CONNECTOR STRIP ASM

DWG. NO.
MMS-1XX-02-XXX-XX-XX-XXX

BY: BRATCHER 04/01/1994 SHEET 3 OF 4

FIG 8

-TR: TAPE & REEL PACKAGING

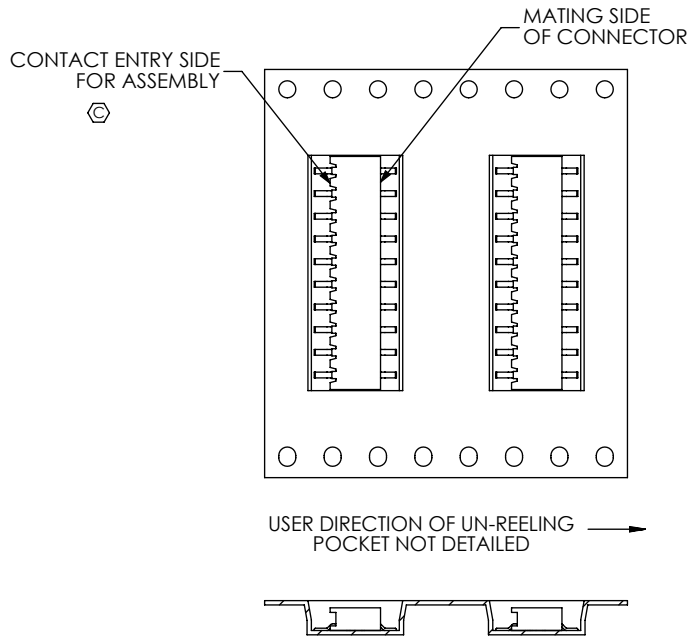

MMS-110-02-XXX-SH SHOWN FOR ORIENTATION OF -SH & -DH STYLES
(MMS-103-02-X-LC, POS 1 TO FACE ROUND HOLES)

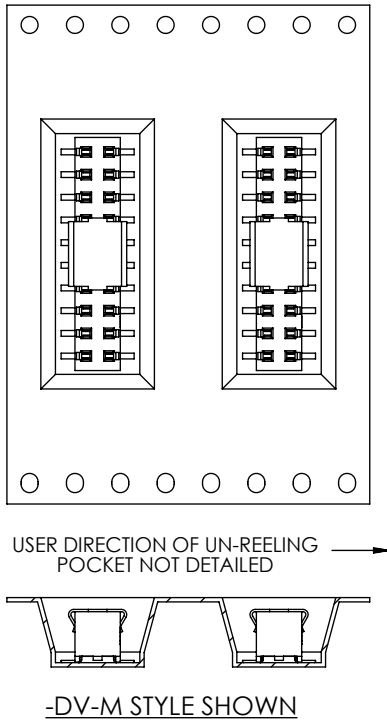

-DV-M STYLE SHOWN

FIG 9

TUBE PACKAGING OPTIONS

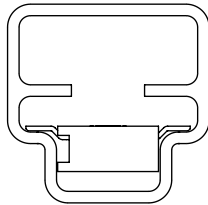

** -SH, -SH-LC
** -SH STYLE SHOWN

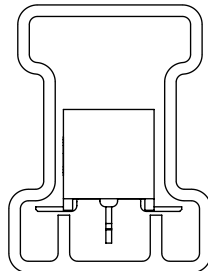

-DV, -DV-LC, -DV-A
-DV-LC STYLE SHOWN

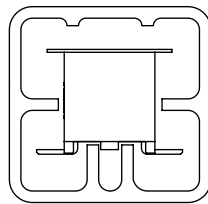

-DV-K, -DV-LC-K, -DV-A-K
-DV-K STYLE SHOWN

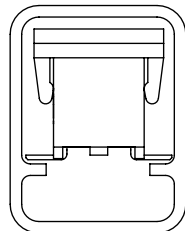

-DV-P, -DV-LC-P, -DV-A-P
-DV-P STYLE SHOWN

TABLE 2 (#1 POSITION TO BE TUBED IN DIRECTION OF ARROW)

LEAD STYLE	PACKAGING TUBE	PLUG
-DV, -DV-LC, -DV-A	PT-1-24-02-17	TP-09
-DV-M, -DV-LC-M, -DV-A-M	PT-1-24-01-63	TP-24
-DV-K, -DV-LC-K, -DV-A-K	PT-1-24-02-63	TP-24
-DV-P, -DV-LC-P, -DV-A-P	PT-BKT001	TP-09
** -SH, -SH-LC	PT-1-24-02-16	TP-24
-DH	PT-1-24-02-17	TP-03
-DH-P, -DH-K	PT-1-24-06-17	TP-24
-DH-LC	PT-1-24-02-17	TP-09
-SV (NOT -02 THRU -04 POS)	PT-1-24-01-16	TP-12
-SV (-02 THRU -04 POS ONLY)	PT-1-24-01-68	TP-12
-SV-P	PT-1-24-13-09	TP-24
-SV-K	PT-1-24-03-63	TP-24

**SEE NOTE 10

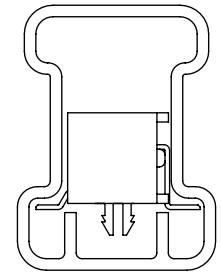

-DH-LC

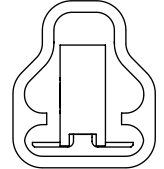

-SV (NOT -02 THRU -04 POS)

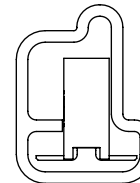

-SV (-02 THRU -04 POS ONLY)

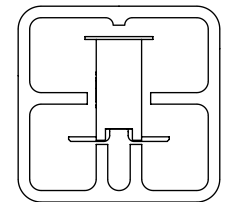

-SV-K

PROPRIETARY NOTE

THIS DOCUMENT CONTAINS CONFIDENTIAL AND PROPRIETARY INFORMATION AND ALL DESIGN, MANUFACTURING, REPRODUCTION, USE, PATENT RIGHTS AND SALES RIGHTS ARE EXPRESSLY RESERVED BY SAMTEC, INC. THIS DOCUMENT SHALL NOT BE DISCLOSED, IN WHOLE OR PART, TO ANY UNAUTHORIZED PERSON OR ENTITY NOR REPRODUCED, TRANSFERRED OR INCORPORATED IN ANY OTHER PROJECT IN ANY MANNER WITHOUT THE EXPRESS WRITTEN CONSENT OF SAMTEC, INC.



520 PARK EAST BLVD, NEW ALBANY, IN 47150
PHONE: 812-944-6733 FAX: 812-948-5047
e-Mail info@SAMTEC.com code 55322

DO NOT SCALE DRAWING

SHEET SCALE: 3:1

DESCRIPTION:
2mm SURFACE MOUNT BOX CONNECTOR STRIP ASM

DWG. NO.
MMS-1XX-02-XXX-XX-XX-XXX

BY: BRATCHER 04/01/1994 SHEET 4 OF 4