

Alle Rechte vorbehalten/ All rights reserved

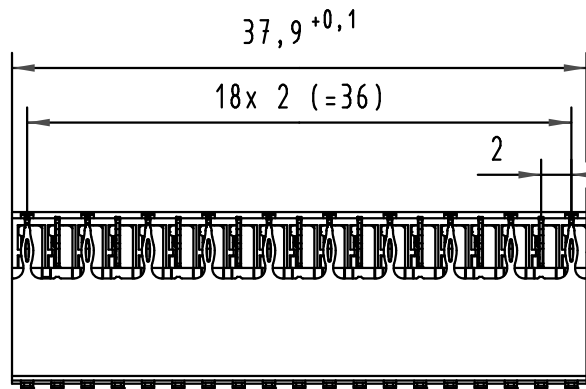

**Lochbild
board drillings**

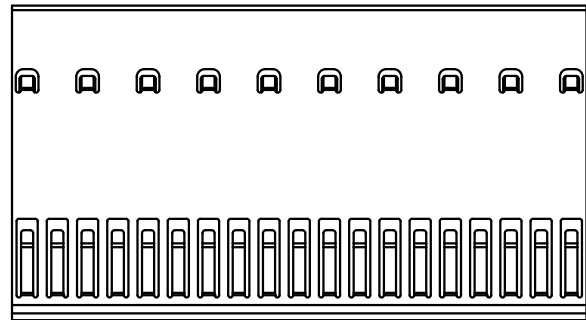
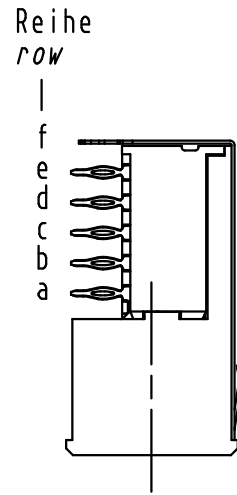
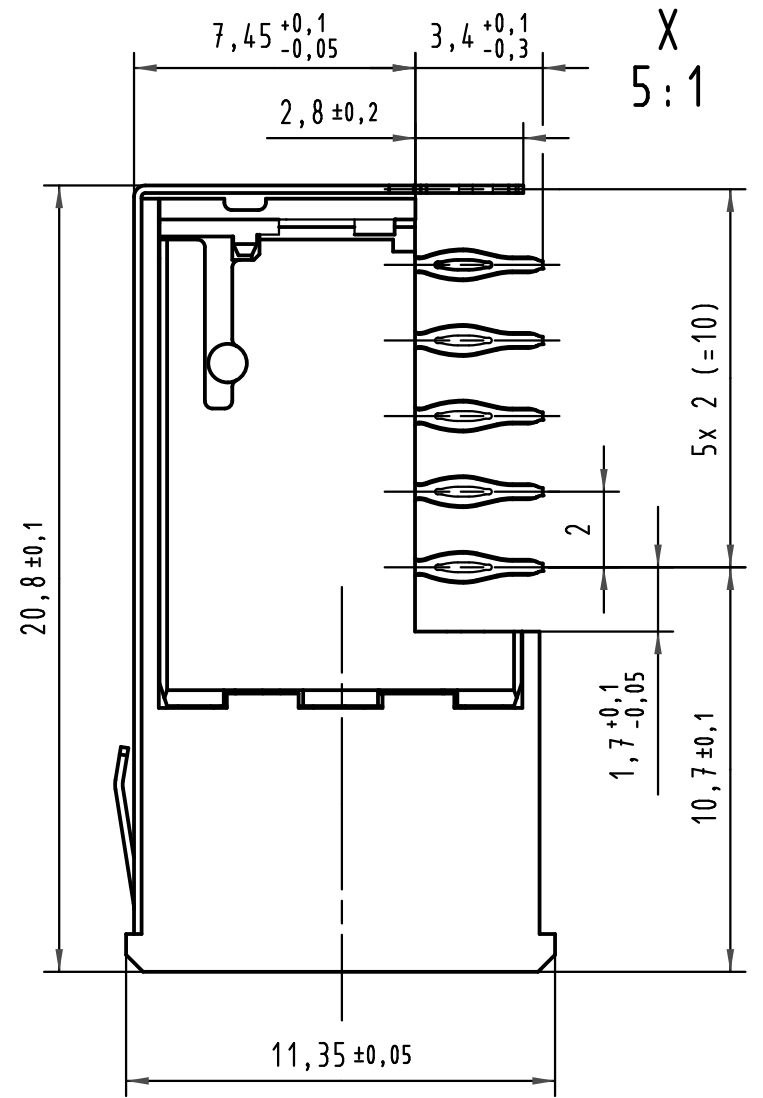
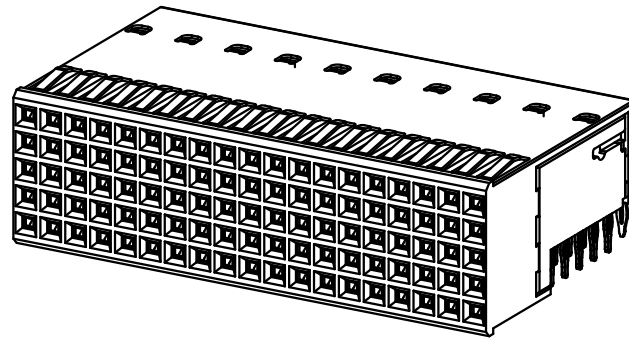
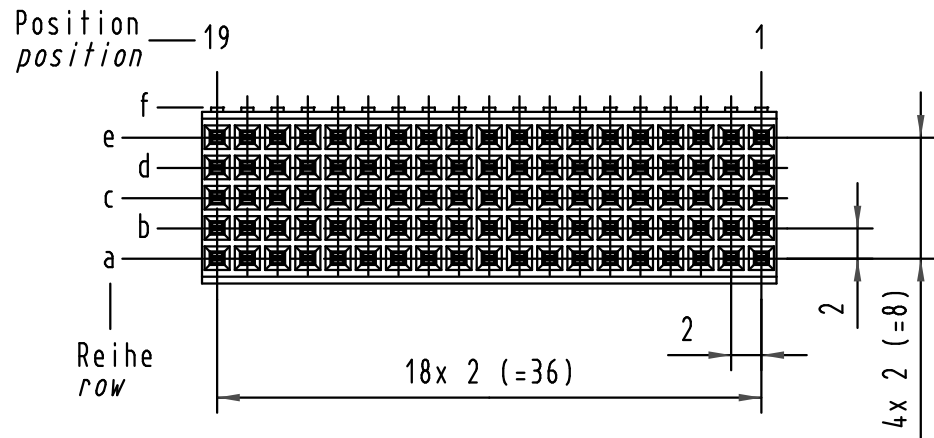
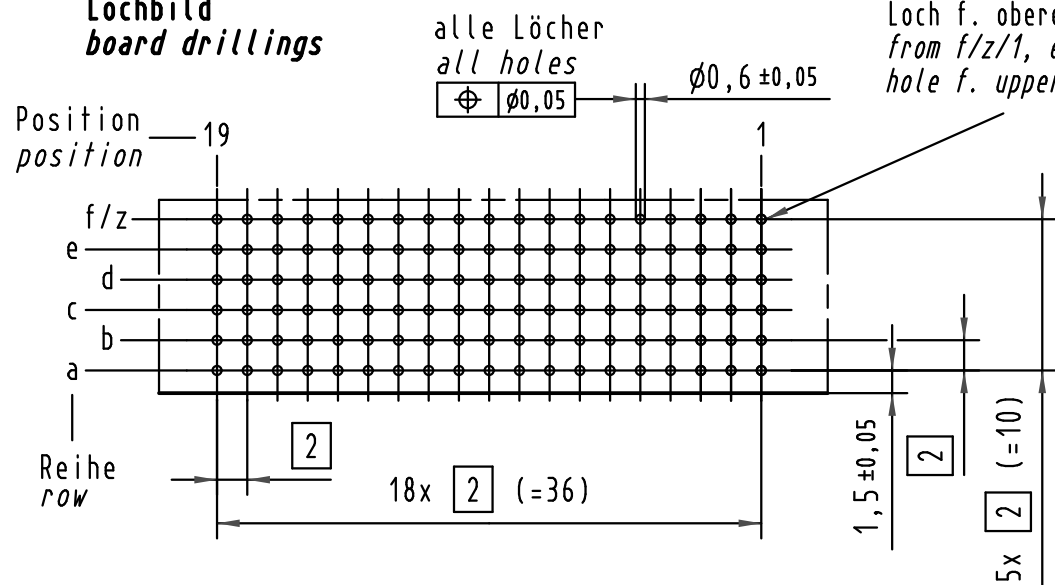

alle Löcher
all holes
⊕ ⌀0,05
⌀0,6 ±0,05

Von f/z/1 aus, jedes 2.
Loch f. obere Abschirmung
from f/z/1, each 2nd
hole f. upper shielding

Bohrlochdurchmesser: $\phi 0,7 \pm 0,02$ mm
Lochdurchmesser (mit Oberfläche): $\phi 0,6 \pm 0,05$ mm
drill hole dia.: $\phi 0,7 \pm 0,02$ mm
through hole dia. (after plating): $\phi 0,6 \pm 0,05$ mm

17 25 095 <u>4</u> 102	—	min.0,76µm (30µm) Au über/over min.1,27µm (50µm) Ni
17 25 095 <u>2</u> 102	2	Au über/over Ni
17 25 095 <u>1</u> 102	1	Au über/over Ni
Bestell-Nr. part-no.	Anforderungsstufe nach IEC performance level acc. to IEC	Kontaktoberfläche contact plating

			Techn. Character.			Nicht tolerierte Maß/Free size tolerances IEC 61076-4-101		
35456	01.12.08	TD	Detail.	30.06.99	Hm	2:1 (5:1)	har-bus HM Federleiste, Typ B-19, 95 pol. mit Schirmblech Reihe-f har-bus HM female connector, type B-19, 95 pol. with shield row-f	
32387	18.11.04	HL.	Insp.	30.06.99	Ko			
29412	07.05.01	Lk	Stand.					
28494	21.09.00	Koe						
25016								
Mod.	Dat.	Name	HARTING Electronics GmbH & Co. KG D-32339 ESPELKAMP			TB 17 25 095 x102		Blatt/ page