

AYA 2W Series

2 Watts

DC/DC Converter

Total Power: 2 Watts
Input Voltage: 4.5 to 10Vdc
9 to 18Vdc
18 to 36Vdc
36 to 75Vdc
of Outputs: Single/Dual

Special Features

- Package size 0.55"x0.55"x0.31"
- High efficiency up to 87%
- I/O isolation voltage 1500Vdc
- Ultra-wide 2:1 input range
- Overload and Short Circuit Protection
- No minimum load requirement
- Operating temperature range: -40 °C to +80 °C

Safety

cUL/UL 60950-1(UL certificate)
IEC/EN 60950-1(CB-report)
CE Mark



Product Descriptions

The AYA 2W series contains single and dual output DC/DC converter modules with industry standard pin configuration. All models feature ultra-wide 2:1 input range with excellent output voltage regulation. The AYA 2W series can deliver up to 2W output power from the single or dual output module with high 87% typical efficiency and excellent thermal performance over an operating ambient temperature range of -40 °C~+80 °C with derating.

Suitable for a wide range of applications in nearly any industry, the AYA 2W series was particularly designed in battery-powered equipment, instrumentation, distributed power architectures in communication, industrial electronics, energy facilities and many other critical applications where PCB space is limited.

Part Numbers

Part Number	Input Voltage	Output Voltage	Output Current	Efficiency
AYA00F05-L	4.5-10Vdc	3.3Vdc	0.4A	79.00%
AYA00F12-L	9-18Vdc	3.3Vdc	0.4A	80.00%
AYA00F24-L	18-36Vdc	3.3Vdc	0.4A	79.00%
AYA00F48-L	36-75Vdc	3.3Vdc	0.4A	79.00%
AYA00A05-L	4.5-10Vdc	5Vdc	0.4A	81.00%
AYA00A12-L	9-18Vdc	5Vdc	0.4A	83.00%
AYA00A24-L	18-36Vdc	5Vdc	0.4A	84.00%
AYA00A48-L	36-75Vdc	5Vdc	0.4A	83.00%
AYA00AA05-L	4.5-10Vdc	+/-5Vdc	0.2A	83.00%
AYA00AA12-L	9-18Vdc	+/-5Vdc	0.2A	84.00%
AYA00AA24-L	18-36Vdc	+/-5Vdc	0.2A	84.00%
AYA00AA48-L	36-75Vdc	+/-5Vdc	0.2A	82.00%
AYA00B05-L	4.5-10Vdc	12Vdc	0.167A	85.00%
AYA00B12-L	9-18Vdc	12Vdc	0.167A	87.00%
AYA00B24-L	18-36Vdc	12Vdc	0.167A	86.00%
AYA00B48-L	36-75Vdc	12Vdc	0.167A	85.00%
AYA00BB05-L	4.5-10Vdc	+/-12Vdc	0.083A	85.00%
AYA00BB12-L	9-18Vdc	+/-12Vdc	0.083A	86.00%
AYA00BB24-L	18-36Vdc	+/-12Vdc	0.083A	86.00%
AYA00BB48-L	36-75Vdc	+/-12Vdc	0.083A	84.00%
AYA00C05-L	4.5-10Vdc	15Vdc	0.134A	87.00%
AYA00C12-L	9-18Vdc	15Vdc	0.134A	87.00%
AYA00C24-L	18-36Vdc	15Vdc	0.134A	87.00%
AYA00C48-L	36-75Vdc	15Vdc	0.134A	86.00%
AYA00CC05-L	4.5-10Vdc	+/-15Vdc	0.067A	85.00%
AYA00CC12-L	9-18Vdc	+/-15Vdc	0.067A	86.00%
AYA00CC24-L	18-36Vdc	+/-15Vdc	0.067A	86.00%
AYA00CC48-L	36-75Vdc	+/-15Vdc	0.067A	84.00%

Electrical Specifications

Absolute Maximum Ratings

Stress in excess of those listed in the “Absolute Maximum Ratings” may cause permanent damage to the power supply. These are stress ratings only and functional operation of the unit is not implied at these or any other conditions above those given in the operational sections of this TRN. Exposure to any absolute maximum rated condition for extended periods may adversely affect the power supply’s reliability.

Table 1. Absolute Maximum Ratings:

Parameter	Model	Symbol	Min	Typ	Max	Unit
Input Voltage Operating-Continuous	5V input models	$V_{IN,DC}$	4.5	-	10	Vdc
	12V input models		9	-	18	
	24V input models		18	-	36	
	48V input models		36	-	75	
Maximum Output Power	All models	$P_{O,max}$	-	-	2	W
Isolation Voltage Input to output (60 Sec) Input to output (1 Sec)	All models		1500	-	-	Vdc
			1800	-	-	
Isolation Resistance 500Vdc	All models		1000	-	-	Mohm
Operating Ambient Temperature	All models	T_A	-40	-	+80	°C
Operating Case Temperature	All models	T_{CASE}	-	-	+95	°C
Storage Temperature	All models	T_{STG}	-50	-	+125	°C
Humidity (non-condensing) Operating Non-operating	All models		-	-	95	% rel. H
	All models		-	-	95	
Cooling	All models	Natural Convection ¹				
Lead Temperature	All models		-	-	260 ²	°C

Note 1 – The Natural Convection is about 20 LFM, but not equal to still air (0 LFM)

Note 2 – 1.5mm from case for 10 Sec

Input Specifications

Table 2. Input Specifications:

Parameter		Condition	Symbol	Min	Nom	Max	Unit
Operating Input Voltage, DC	5V input models	All	$V_{IN,DC}$	4.5	5	10	Vdc
	12V input models			9	12	18	
	24V input models			18	24	36	
	48V input models			36	48	75	
Input Surge Voltage	5V input models	1 Sec, max	$V_{IN,surge}$	-0.7	-	12	Vdc
	12V input models			-0.7	-	25	
	24V input models			-0.7	-	50	
	48V input models			-0.7	-	100	
Start-up Threshold Voltage	5V input models	All	$V_{IN,ON}$	-	-	4.5	Vdc
	12V input models			-	-	9	
	24V input models			-	-	18	
	48V input models			-	-	36	
Input Current	AYA00F05-L	$V_{IN,DC}=V_{IN,nom}$ $I_O=I_{O,max}$	$I_{IN,full\ load}$	-	334	-	mA
	AYA00F12-L			-	138	-	
	AYA00F24-L			-	70	-	
	AYA00F48-L			-	35	-	
	AYA00A05-L			-	494	-	
	AYA00A12-L			-	201	-	
	AYA00A24-L			-	99	-	
	AYA00A48-L			-	50	-	
	AYA00AA05-L			-	482	-	
	AYA00AA12-L			-	198	-	
	AYA00AA24-L			-	99	-	
	AYA00AA48-L			-	51	-	
	AYA00B05-L			-	472	-	
	AYA00B12-L			-	192	-	
	AYA00B24-L			-	97	-	
	AYA00B48-L			-	49	-	
	AYA00BB05-L			-	469	-	
	AYA00BB12-L			-	193	-	
	AYA00BB24-L			-	97	-	
	AYA00BB48-L			-	49	-	
	AYA00C05-L			-	462	-	
	AYA00C12-L			-	193	-	
	AYA00C24-L			-	96	-	
	AYA00C48-L			-	49	-	
AYA00CC05-L	-	473	-				
AYA00CC12-L	-	195	-				
AYA00CC24-L	-	97	-				
AYA00CC48-L	-	50	-				

Input Specifications

Table 2. Input Specifications con't:

Parameter		Condition	Symbol	Min	Nom	Max	Unit
No Load Input Current	5V input Models	$V_{IN,DC}=V_{IN,nom}$ $I_O=0A$	$I_{IN,no-load}$	-	40	-	mA
	12V input Models			-	27	-	
	24V input Models			-	15	-	
	48V input Models			-	8	-	
Efficiency	AYA00F05-L	$V_{IN,DC}=V_{IN,nom}$ $I_O=I_{O,max}$ $T_A=25^{\circ}C$	η	-	79	-	%
	AYA00F12-L			-	80	-	
	AYA00F24-L			-	79	-	
	AYA00F48-L			-	79	-	
	AYA00A05-L			-	81	-	
	AYA00A12-L			-	83	-	
	AYA00A24-L			-	84	-	
	AYA00A48-L			-	83	-	
	AYA00AA05-L			-	83	-	
	AYA00AA12-L			-	84	-	
	AYA00AA24-L			-	84	-	
	AYA00AA48-L			-	82	-	
	AYA00B05-L			-	85	-	
	AYA00B12-L			-	87	-	
	AYA00B24-L			-	86	-	
	AYA00B48-L			-	85	-	
	AYA00BB05-L			-	85	-	
	AYA00BB12-L			-	86	-	
	AYA00BB24-L			-	86	-	
	AYA00BB48-L			-	84	-	
	AYA00C05-L			-	87	-	
	AYA00C12-L			-	87	-	
	AYA00C24-L			-	87	-	
AYA00C48-L	-	86	-				
AYA00CC05-L	-	85	-				
AYA00CC12-L	-	86	-				
AYA00CC24-L	-	86	-				
AYA00CC48-L	-	84	-				
Short Circuit Input Power		All		-	-	0.5	mW
Internal Filter			Internal Capacitor				

Output Specifications

Table 3. Output Specifications:

Parameter	Condition	Symbol	Min	Nom	Max	Unit	
Output Voltage Set-Point	$V_{IN,DC}=V_{IN,nom}$ $I_O=I_{O,max}$ $T_A=25\text{ }^\circ\text{C}$	$\pm V_{O,set}$	-	-	1.5	%	
Output Ripple, pk-pk	20MHz bandwidth, measured with a 1uF MLCC and a 10uF Tantalum Capacitor	V_O	-	70	-	mV	
Line Regulation	$V_{IN,DC}=V_{IN,min}$ to $V_{IN,max}$ $I_O=I_{O,max}$	$\pm\%V_O$	-	-	0.2	%	
Load Regulation	$V_{IN,DC}=V_{IN,nom}$ $I_O=0$ to $100\% I_{O,max}$	$\pm\%V_O$	-	-	1.0	%	
V_O Dynamic Response	Peak Deviation Settling Time	$V_{IN,DC}=V_{IN,nom}$ 25% load change, slew rate=1A/uS	$\pm\%V_O$	-	3	5	%
				-	250	500	uSec
V_O Load Capacitance	For each output		-	-	100	uF	
Output Current	AYA00F05-L	Convection cooling	I_O	-	-	0.4	A
	AYA00F12-L			-	-	0.4	
	AYA00F24-L			-	-	0.4	
	AYA00F48-L			-	-	0.4	
	AYA00A05-L			-	-	0.4	
	AYA00A12-L			-	-	0.4	
	AYA00A24-L			-	-	0.4	
	AYA00A48-L			-	-	0.4	
	AYA00AA05-L			-	-	± 0.2	
	AYA00AA12-L			-	-	± 0.2	
	AYA00AA24-L			-	-	± 0.2	
	AYA00AA48-L			-	-	± 0.2	
	AYA00B05-L			-	-	0.167	
	AYA00B12-L			-	-	0.167	
	AYA00B24-L			-	-	0.167	
	AYA00B48-L			-	-	0.167	
	AYA00BB05-L			-	-	± 0.083	
	AYA00BB12-L			-	-	± 0.083	
	AYA00BB24-L			-	-	± 0.083	
	AYA00BB48-L			-	-	± 0.083	
	AYA00C05-L			-	-	0.134	
	AYA00C12-L			-	-	0.134	
	AYA00C24-L			-	-	0.134	
	AYA00C48-L			-	-	0.134	
AYA00CC05-L	-	-	± 0.067				
AYA00CC12-L	-	-	± 0.067				
AYA00CC24-L	-	-	± 0.067				
AYA00CC48-L	-	-	± 0.067				

Output Specifications

Table 3. Output Specifications con't:

Parameter	Condition	Symbol	Min	Nom	Max	Unit
Temperature Coefficient	All	$\pm\%/^{\circ}\text{C}$	-	0.01	0.02	%
Switching Frequency	All	f_{sw}	100	-	-	KHz
Output Over Current Protection	Foldback		-	180	-	$\%I_{\text{O,max}}$
Output Short Circuit Protection	All		Continuous, Automatic Recovery			
Output Voltage Balance	Dual Output, Balanced load	-	-	-	± 2.0	%
Cross Regulation (Dual)	Asymmetrical load 25% / 100% FL	-	-	-	± 5.0	%
Minimum Load	No minimum load requirement					

AYA00F05-L Performance Curves

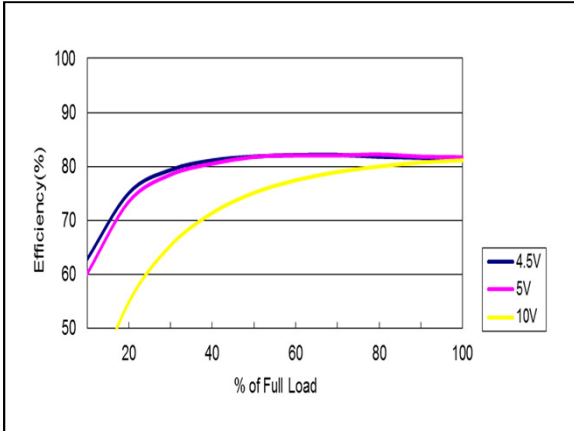

Figure 1: AYA00F05-L Efficiency Versus Output Current Curve
 $V_{IN} = 4.5$ to $10V_{dc}$ Load: $I_O = 0$ to $0.4A$

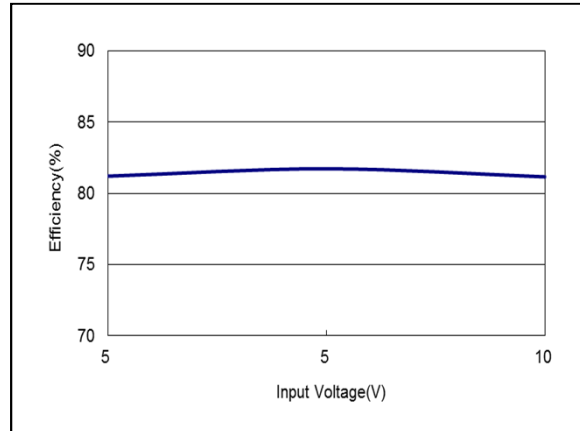

Figure 2: AYA00F05-L Efficiency Versus Input Voltage Curve
 $V_{IN} = 4.5$ to $10V_{dc}$ Load: $I_O = 0.4A$

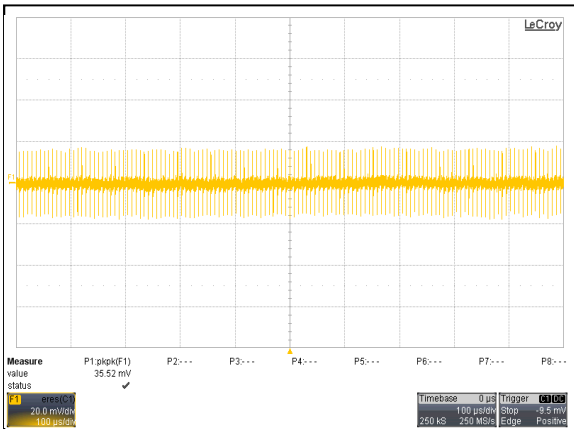

Figure 3: AYA00F05-L Ripple and Noise Measurement
 $V_{IN} = 5V_{dc}$ Load: $I_O = 0.4A$
 Ch 1: V_O

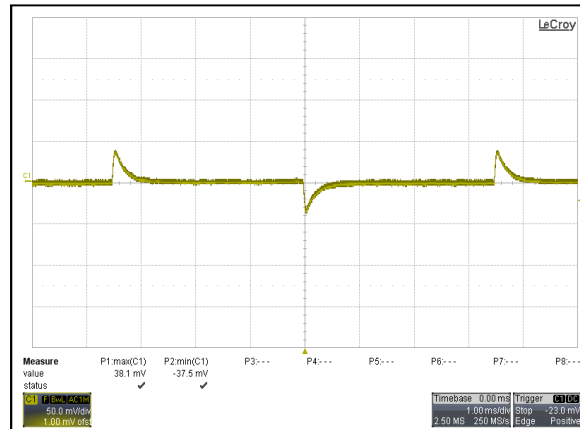

Figure 4: AYA00F05-L Transient Response
 $V_{IN} = 5V_{dc}$ Load: $I_O = 100\%$ to 75% Load Change
 Ch 1: V_O

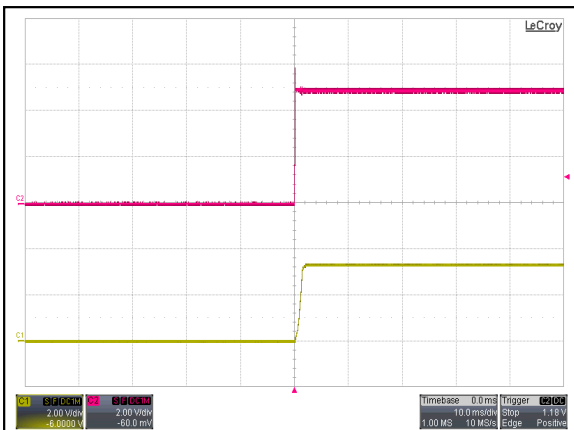

Figure 5: AYA00F05-L Output Voltage Startup Characteristic By V_{IN}
 $V_{IN} = 5V_{dc}$ Load: $I_O = 0.4A$
 Ch1: V_{IN} Ch2: V_O

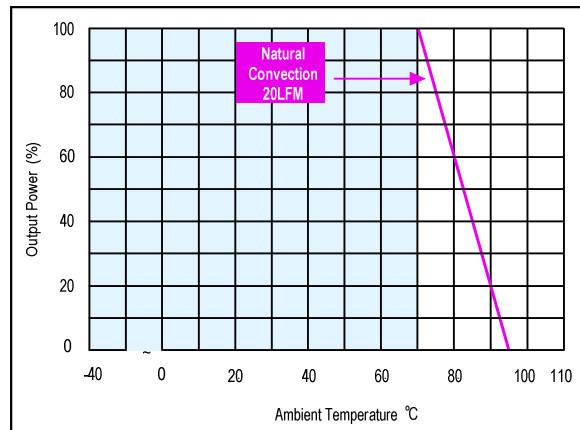

Figure 6: AYA00F05-L Derating Curve
 $V_{IN} = 5V_{dc}$

AYA00A05-L Performance Curves

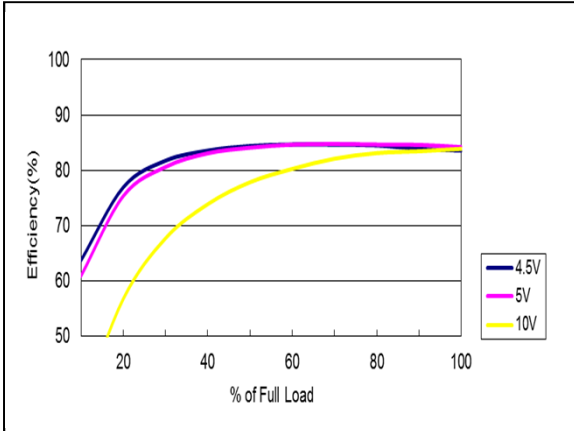

Figure 7: AYA00A05-L Efficiency Versus Output Current Curve
 $V_{IN} = 4.5$ to $10Vdc$ Load: $I_O = 0$ to $0.4A$

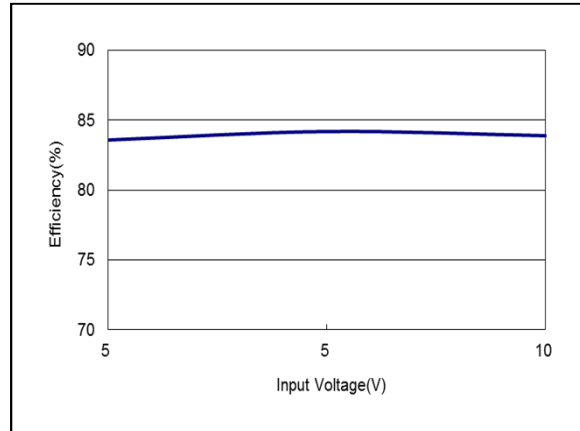

Figure 8: AYA00A05-L Efficiency Versus Input Voltage Curve
 $V_{IN} = 4.5$ to $10Vdc$ Load: $I_O = 0.4A$

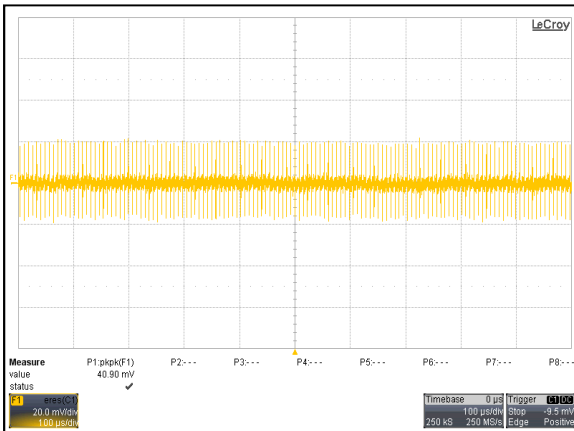

Figure 9: AYA00A05-L Ripple and Noise Measurement
 $V_{IN} = 5Vdc$ Load: $I_O = 0.4A$
 Ch 1: V_O

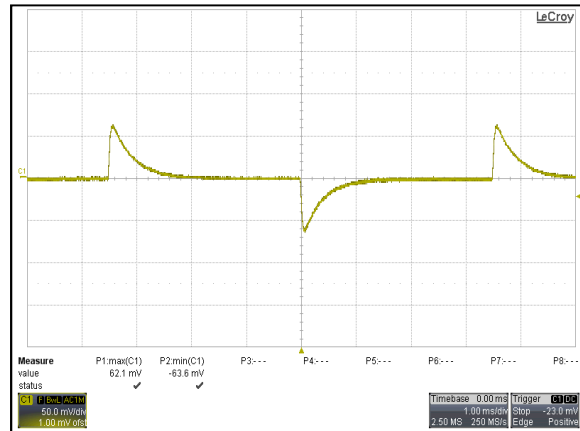

Figure 10: AYA00A05-L Transient Response
 $V_{IN} = 5Vdc$ Load: $I_O = 100\%$ to 75% Load Change
 Ch 1: V_O

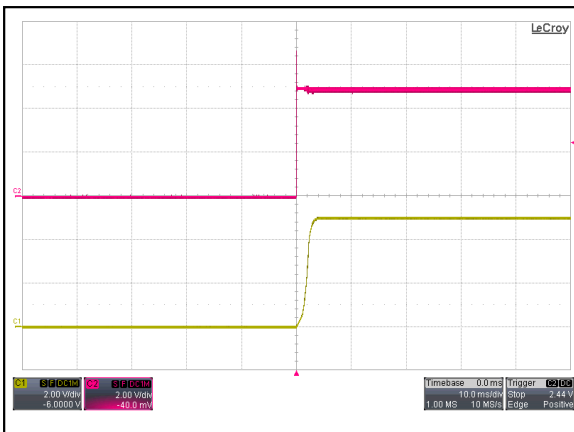

Figure 11: AYA00A05-L Output Voltage Startup Characteristic By V_{IN}
 $V_{IN} = 5Vdc$ Load: $I_O = 0.4A$
 Ch1: V_{IN} Ch2: V_O

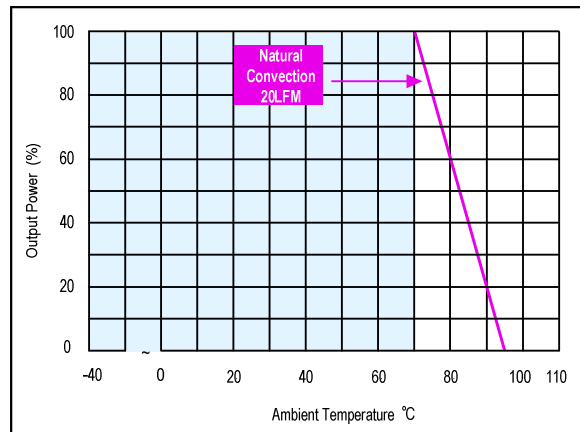

Figure 12: AYA00A05-L Derating Curve
 $V_{IN} = 5Vdc$

AYA00AA05-L Performance Curves

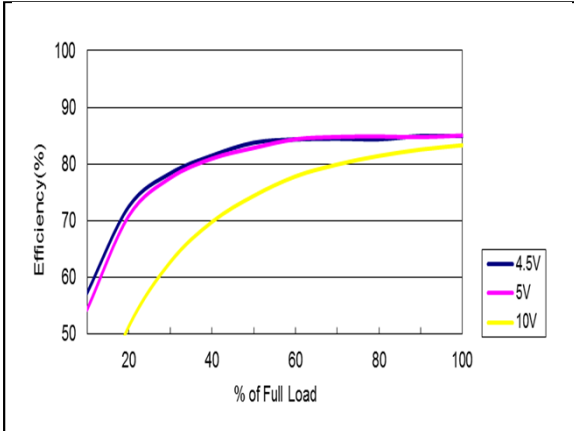

Figure 13: AYA00AA05-L Efficiency Versus Output Current Curve
 $V_{IN} = 4.5$ to $10V_{dc}$ Load: $I_O = 0$ to $0.2A$

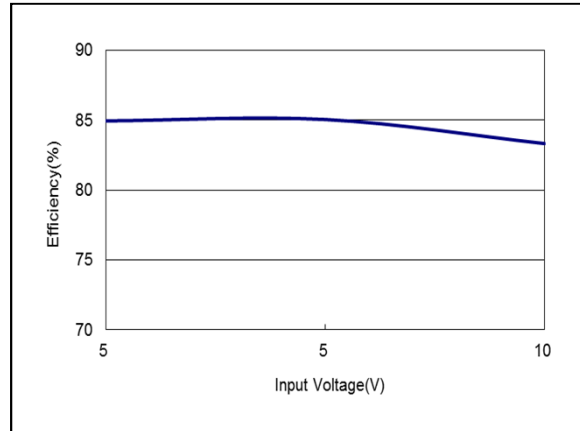

Figure 14: AYA00AA05-L Efficiency Versus Input Voltage Curve
 $V_{IN} = 4.5$ to $10V_{dc}$ Load: $I_O = 0.2A$

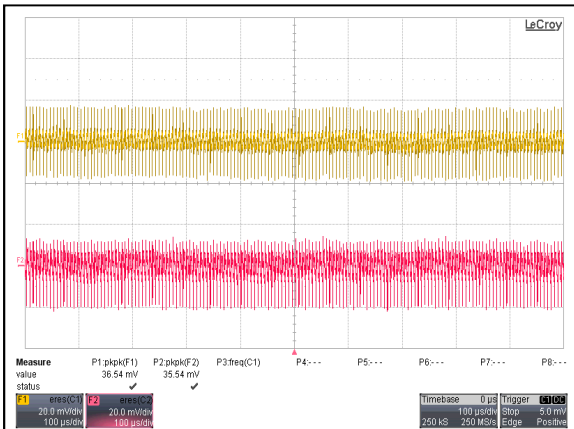

Figure 15: AYA00AA05-L Ripple and Noise Measurement
 $V_{IN} = 5V_{dc}$ Load: $I_O = 0.2A$
 Ch 1: V_{O1} Ch 2: V_{O2}

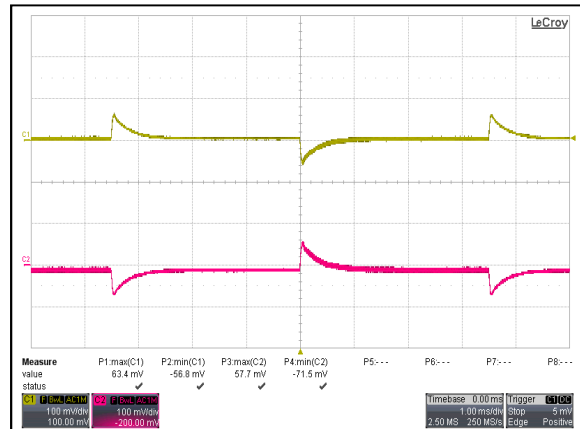

Figure 16: AYA00AA05-L Transient Response
 $V_{IN} = 5V_{dc}$ Load: $I_O = 100\%$ to 75% Load Change
 Ch 1: V_{O1} Ch 2: V_{O2}

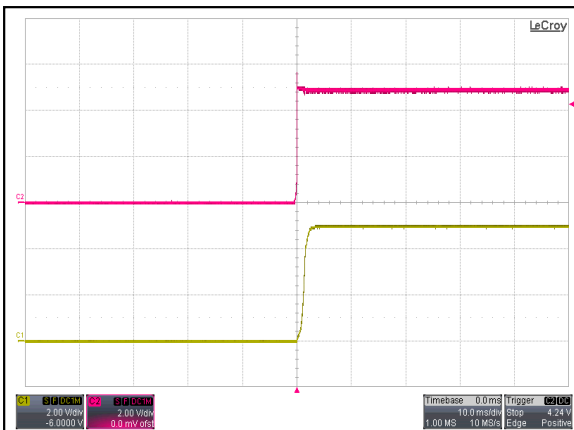

Figure 17: AYA00AA05-L Output Voltage Startup Characteristic By V_{IN}
 $V_{IN} = 5V_{dc}$ Load: $I_O = 0.2A$
 Ch 1: V_{IN} Ch 2: V_O

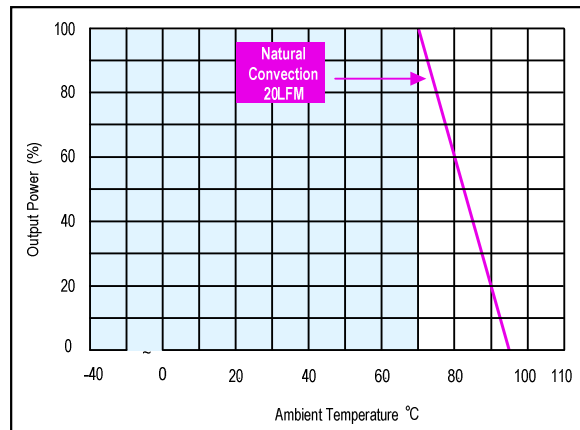

Figure 18: AYA00AA05-L Derating Curve
 $V_{IN} = 5V_{dc}$

AYA00B05-L Performance Curves

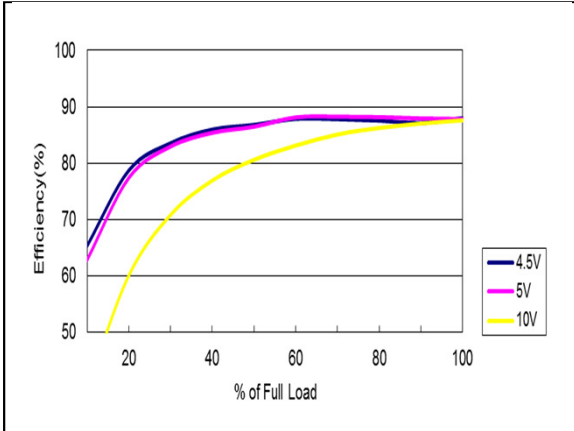

Figure 19: AYA00B05-L Efficiency Versus Output Current Curve
 $V_{IN} = 4.5$ to $10V_{dc}$ Load: $I_O = 0$ to $0.167A$

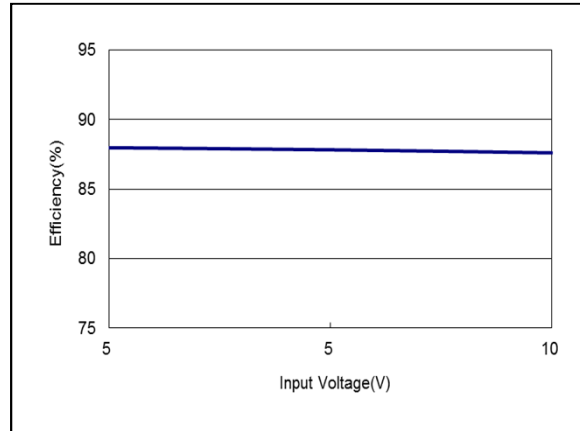

Figure 20: AYA00B05-L Efficiency Versus Input Voltage Curve
 $V_{IN} = 4.5$ to $10V_{dc}$ Load: $I_O = 0.167A$

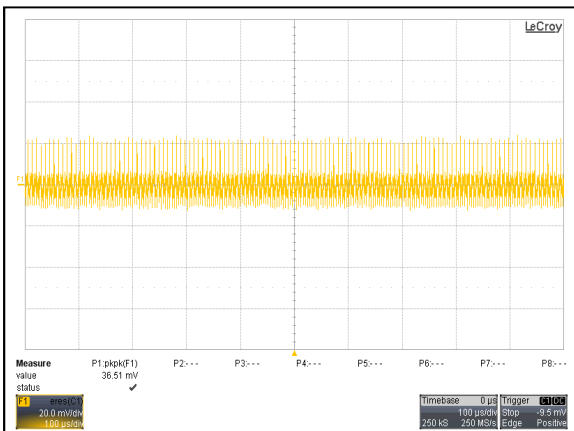

Figure 21: AYA00B05-L Ripple and Noise Measurement
 $V_{IN} = 5V_{dc}$ Load: $I_O = 0.167A$
 Ch 1: V_O

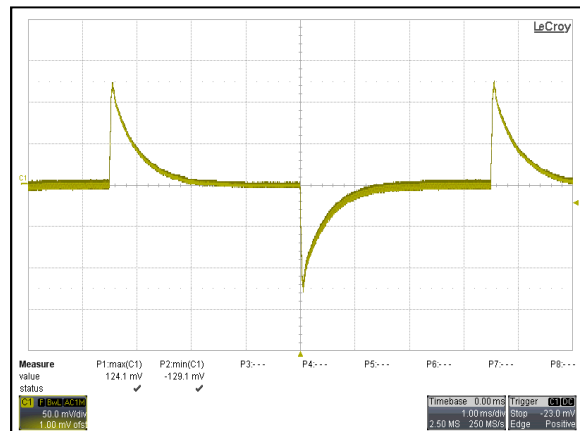

Figure 22: AYA00B05-L Transient Response
 $V_{IN} = 5V_{dc}$ Load: $I_O = 100\%$ to 75% Load Change
 Ch 1: V_O

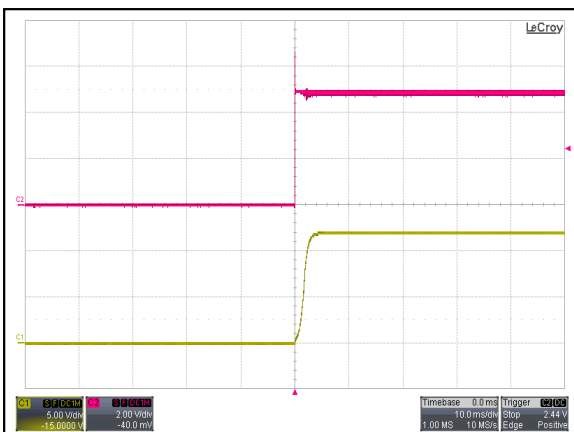

Figure 23: AYA00B05-L Output Voltage Startup Characteristic By V_{IN}
 $V_{IN} = 5V_{dc}$ Load: $I_O = 0.167A$
 Ch1: V_{IN} Ch2: V_O

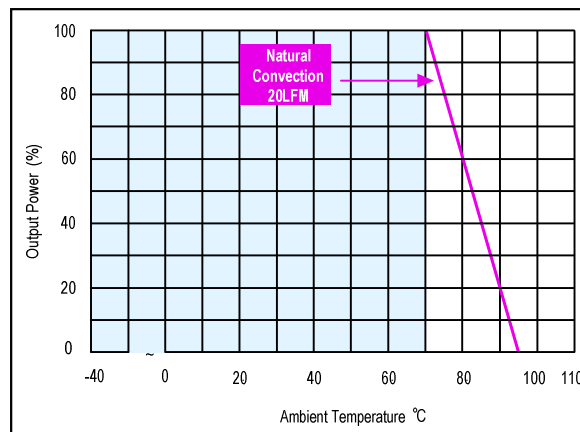

Figure 24: AYA00B05-L Derating Curve
 $V_{IN} = 5V_{dc}$

AYA00BB05-L Performance Curves

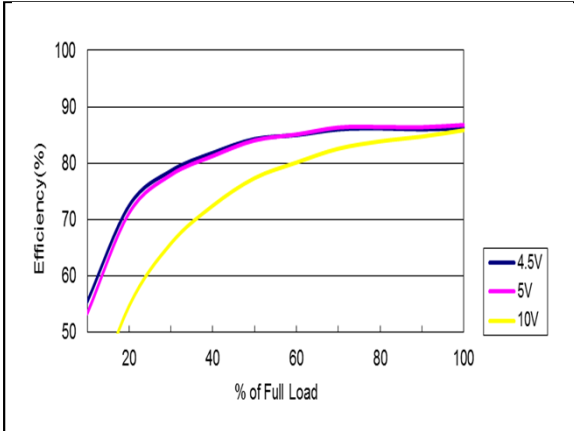

Figure 25: AYA00BB05-L Efficiency Versus Output Current Curve
 $V_{IN} = 4.5$ to $10Vdc$ Load: $I_o = 0.083A$

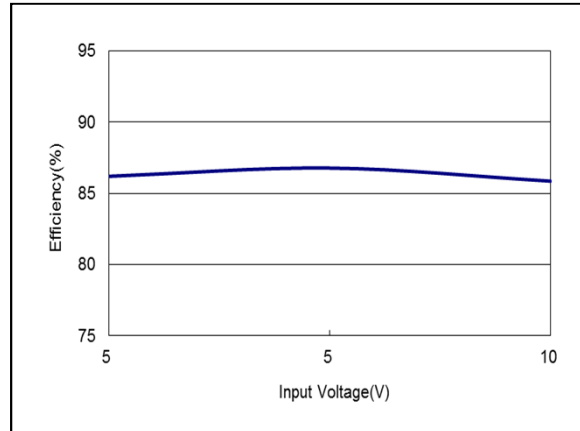

Figure 26: AYA00BB05-L Efficiency Versus Input Voltage Curve
 $V_{IN} = 4.5$ to $10Vdc$ Load: $I_o = 0.083A$

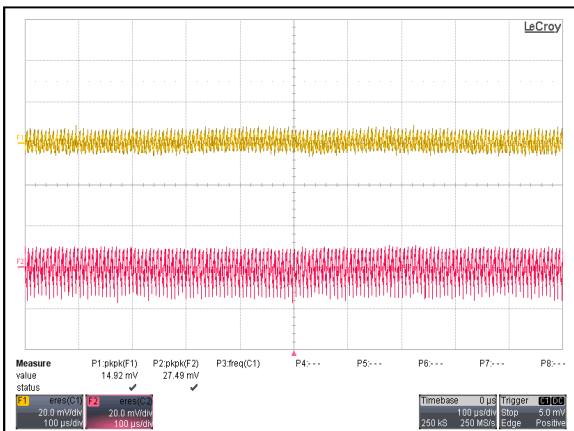

Figure 27: AYA00BB05-L Ripple and Noise Measurement
 $V_{IN} = 5Vdc$ Load: $I_o = 0.083A$
 Ch 1: V_{O1} Ch 2: V_{O2}

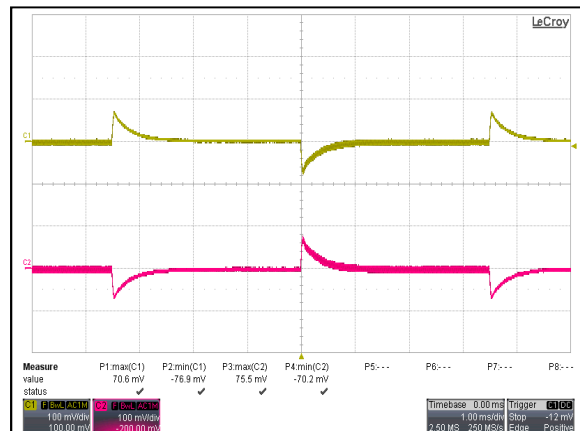

Figure 28: AYA00BB05-L Transient Response
 $V_{IN} = 5Vdc$ Load: $I_o = 100\%$ to 75% Load Change
 Ch 1: V_{O1} Ch 2: V_{O2}

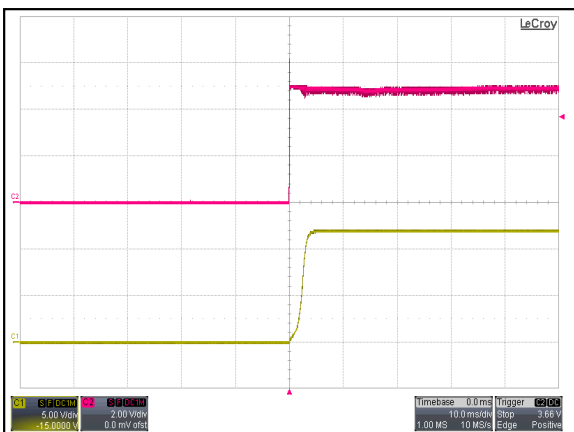

Figure 29: AYA00BB05-L Output Voltage Startup Characteristic By V_{IN}
 $V_{IN} = 5Vdc$ Load: $I_o = 0.083A$
 Ch 1: V_{IN} Ch 2: V_O

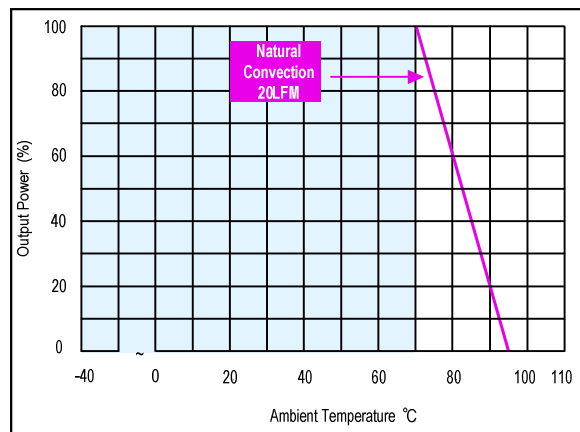

Figure 30: AYA00BB05-L Derating Curve
 $V_{IN} = 5Vdc$

AYA00C05-L Performance Curves

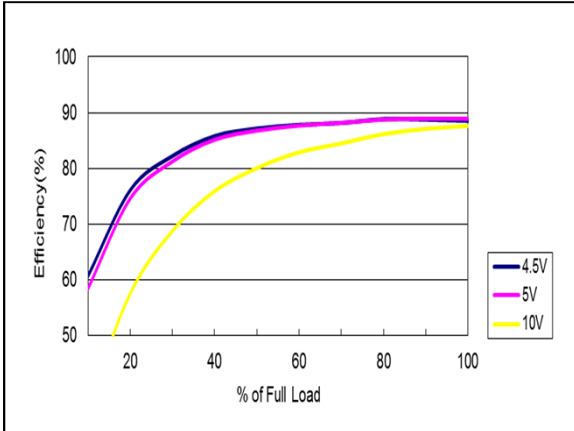

Figure 31: AYA00C05-L Efficiency Versus Output Current Curve
 $V_{IN} = 4.5$ to $10V_{dc}$ Load: $I_O = 0.134A$

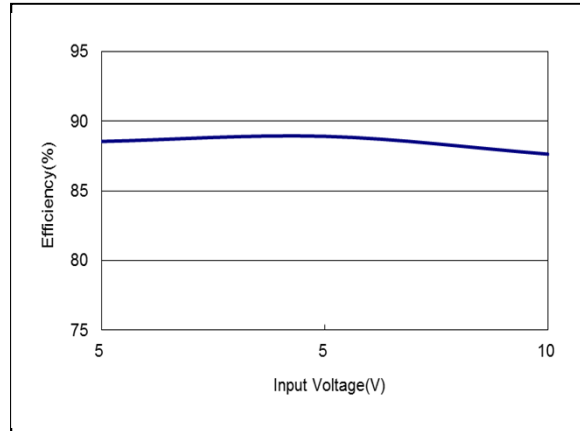

Figure 32: AYA00C05-L Efficiency Versus Input Voltage Curve
 $V_{IN} = 4.5$ to $10V_{dc}$ Load: $I_O = 0.134A$

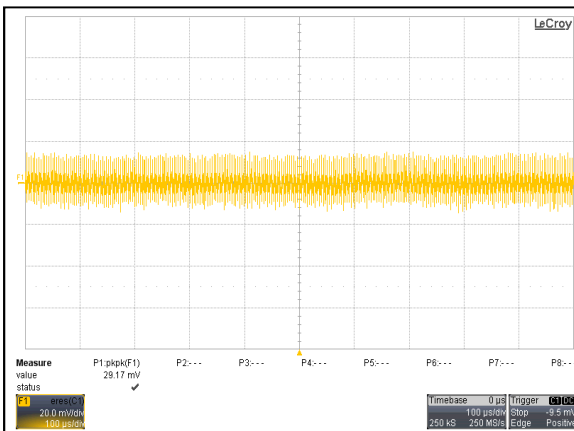

Figure 33: AYA00C05-L Ripple and Noise Measurement
 $V_{IN} = 5V_{dc}$ Load: $I_O = 0.134A$
 Ch 1: V_O

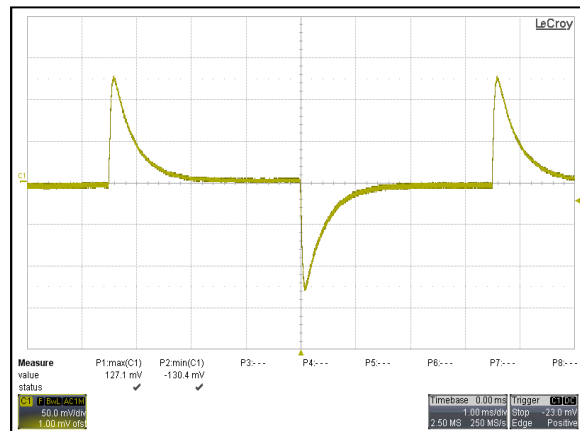

Figure 34: AYA00C05-L Transient Response
 $V_{IN} = 5V_{dc}$ Load: $I_O = 100\%$ to 75% Load Change
 Ch 1: V_O

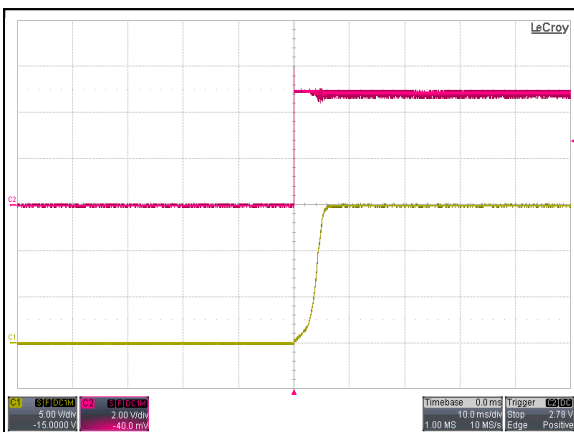

Figure 35: AYA00C05-L Output Voltage Startup Characteristic By V_{IN}
 $V_{IN} = 5V_{dc}$ Load: $I_O = 0.134A$
 Ch1: V_{IN} Ch2: V_O

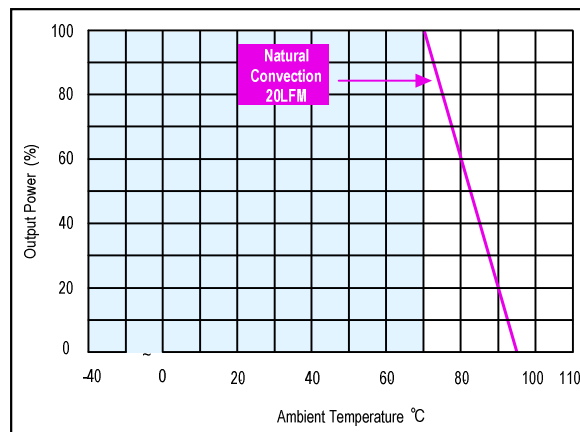

Figure 36: AYA00C05-L Derating Curve
 $V_{IN} = 5V_{dc}$

AYA00CC05-L Performance Curves

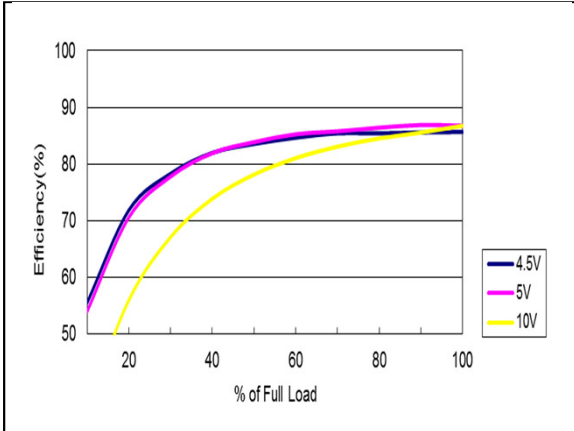

Figure 37: AYA00CC05-L Efficiency Versus Output Current Curve
 $V_{IN} = 4.5$ to $10V_{dc}$ Load: $I_O = 0.067A$

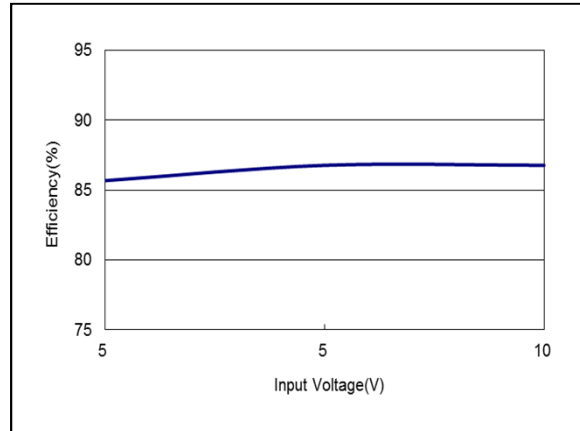

Figure 38: AYA00CC05-L Efficiency Versus Input Voltage Curve
 $V_{IN} = 4.5$ to $10V_{dc}$ Load: $I_O = 0.067A$

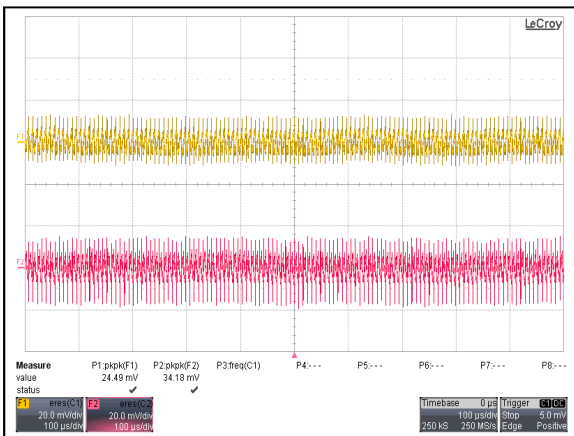

Figure 39: AYA00CC05-L Ripple and Noise Measurement
 $V_{IN} = 5V_{dc}$ Load: $I_O = 0.067A$
 Ch 1: V_{O1} Ch 2: V_{O2}

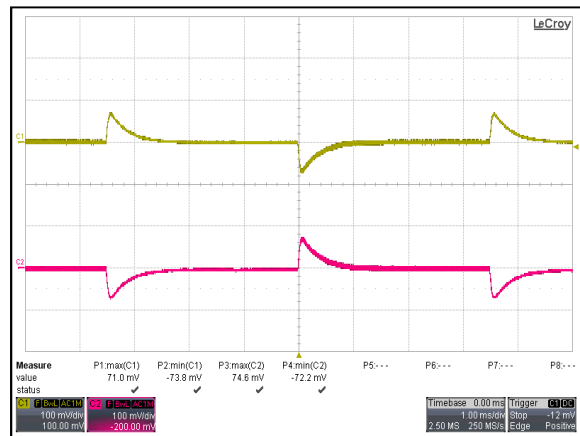

Figure 40: AYA00CC05-L Transient Response
 $V_{IN} = 5V_{dc}$ Load: $I_O = 100\%$ to 75% Load Change
 Ch 1: V_{O1} Ch 2: V_{O2}

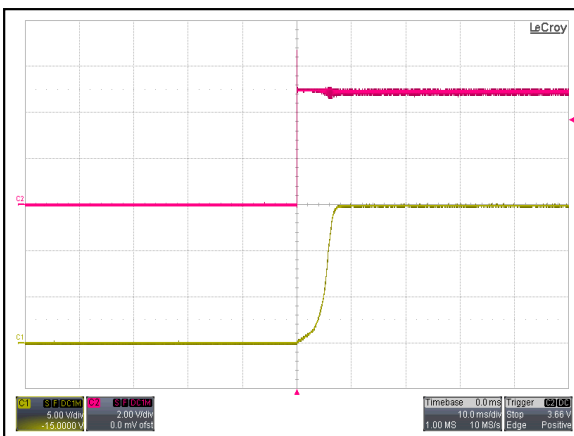

Figure 41: AYA00CC05-L Output Voltage Startup Characteristic By V_{IN}
 $V_{IN} = 5V_{dc}$ Load: $I_O = 0.067A$
 Ch1: V_{IN} Ch2: V_O

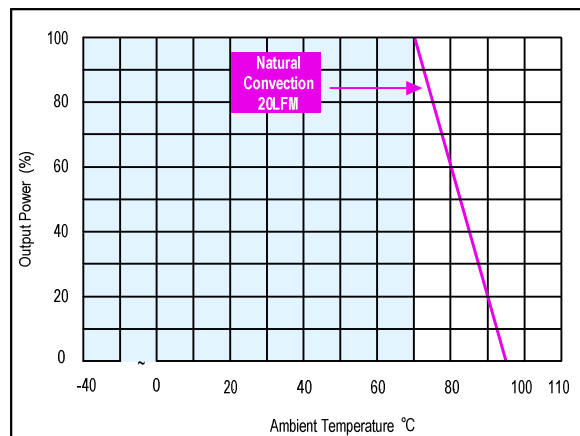

Figure 42: AYA00CC05-L Derating Curve
 $V_{IN} = 5V_{dc}$

AYA00F12-L Performance Curves

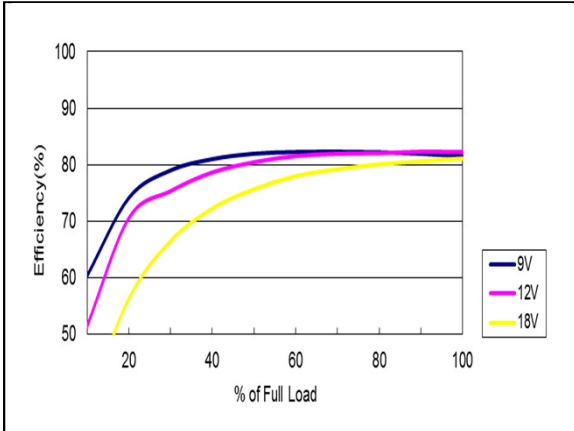

Figure 43: AYA00F12-L Efficiency Versus Output Current Curve
 $V_{IN} = 9$ to 18Vdc Load: $I_o = 0.4A$

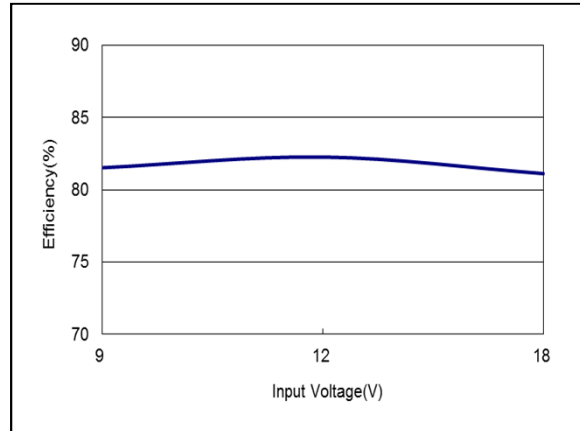

Figure 44: AYA00F12-L Efficiency Versus Input Voltage Curve
 $V_{IN} = 9$ to 18Vdc Load: $I_o = 0.4A$

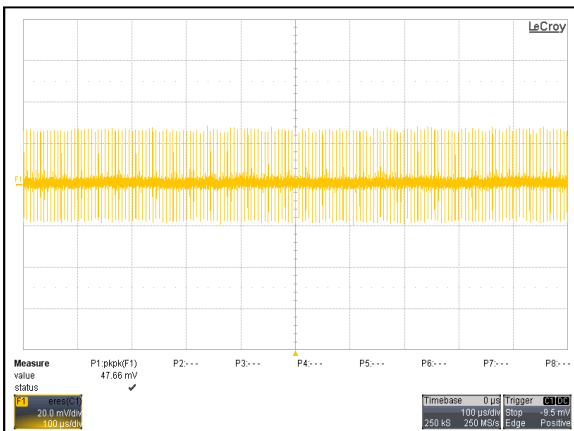

Figure 45: AYA00F12-L Ripple and Noise Measurement
 $V_{IN} = 12Vdc$ Load: $I_o = 0.4A$
 Ch 1: V_o

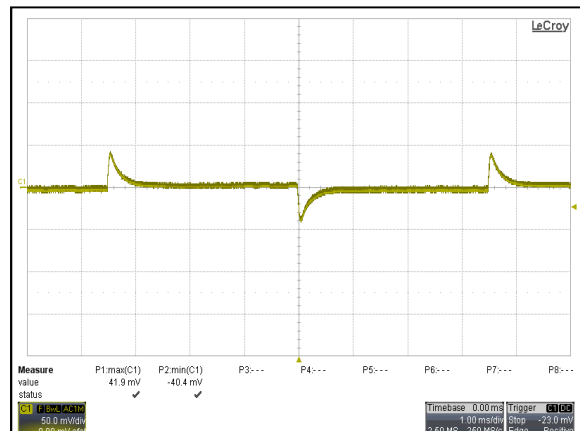

Figure 46: AYA00F12-L Transient Response
 $V_{IN} = 12Vdc$ Load: $I_o = 100\%$ to 75% Load Change
 Ch 1: V_o

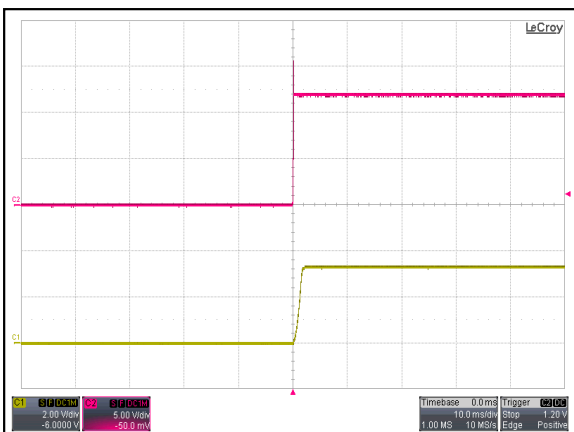

Figure 47: AYA00F12-L Output Voltage Startup Characteristic By V_{IN}
 $V_{IN} = 12Vdc$ Load: $I_o = 0.4A$
 Ch1: V_{IN} Ch2: V_o

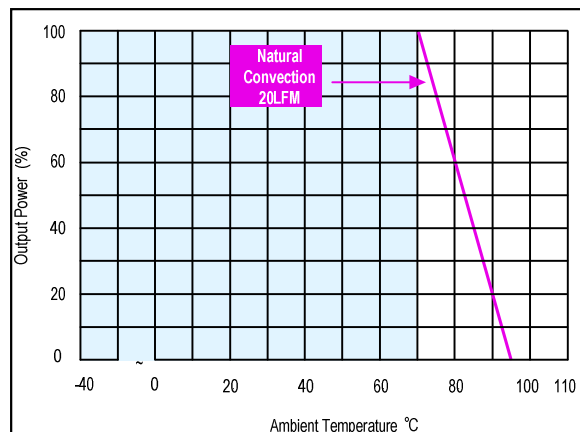

Figure 48: AYA00F12-L Derating Curve
 $V_{IN} = 12Vdc$

AYA00A12-L Performance Curves

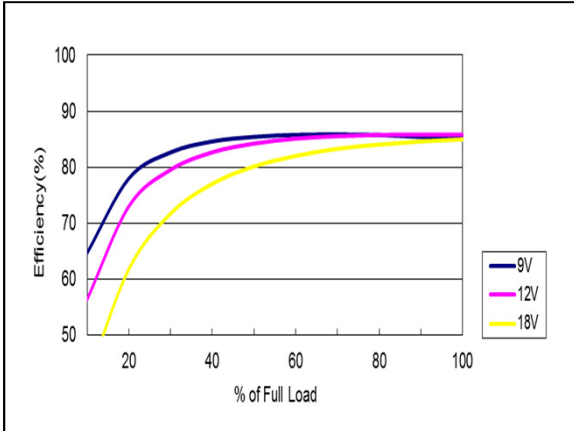

Figure 49: AYA00A12-L Efficiency Versus Output Current Curve
 $V_{IN} = 9$ to 18Vdc Load: $I_O = 0.4A$

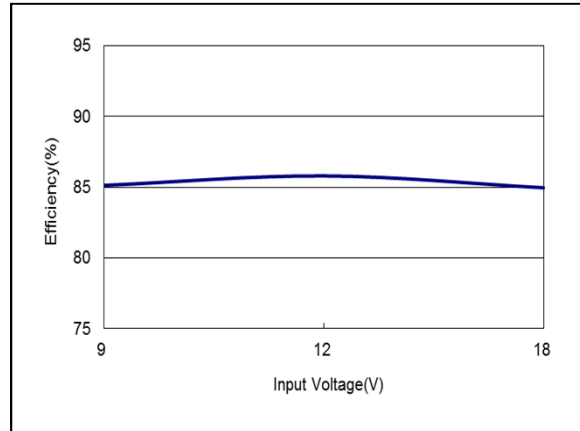

Figure 50: AYA00A12-L Efficiency Versus Input Voltage Curve
 $V_{IN} = 9$ to 18Vdc Load: $I_O = 0.4A$

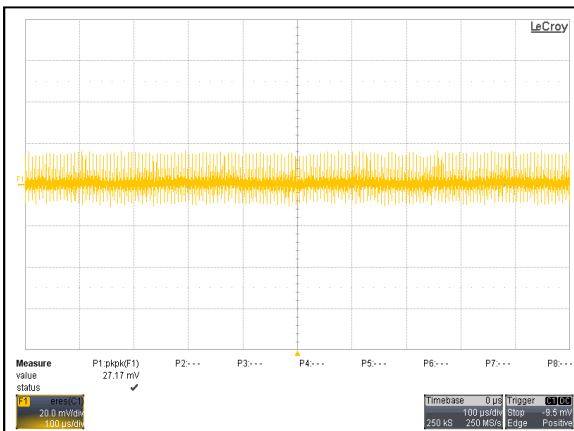

Figure 51: AYA00A12-L Ripple and Noise Measurement
 $V_{IN} = 12Vdc$ Load: $I_O = 0.4A$
 Ch 1: V_O

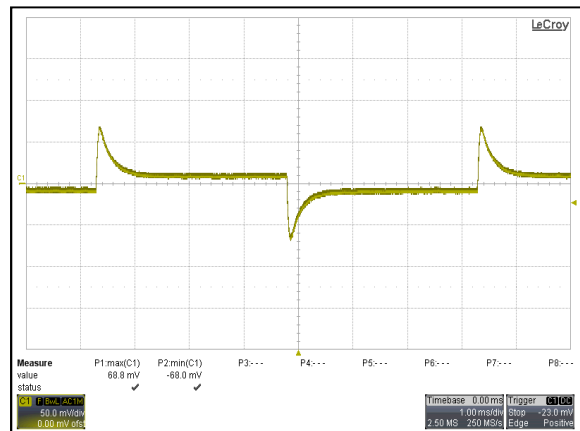

Figure 52: AYA00A12-L Transient Response
 $V_{IN} = 12Vdc$ Load: $I_O = 100\%$ to 75% Load Change
 Ch 1: V_O

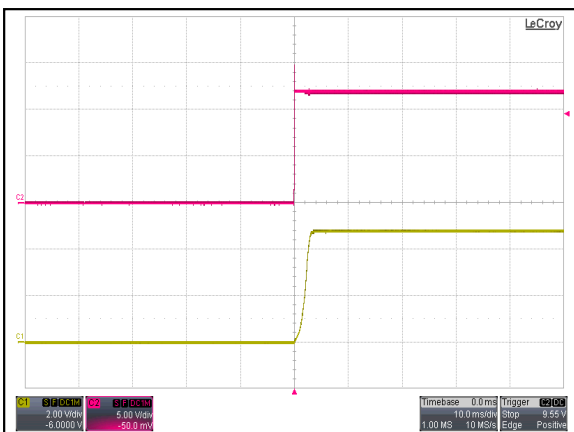

Figure 53: AYA00A12-L Output Voltage Startup Characteristic By V_{IN}
 $V_{IN} = 12Vdc$ Load: $I_O = 0.4A$
 Ch1: V_{IN} Ch2: V_O

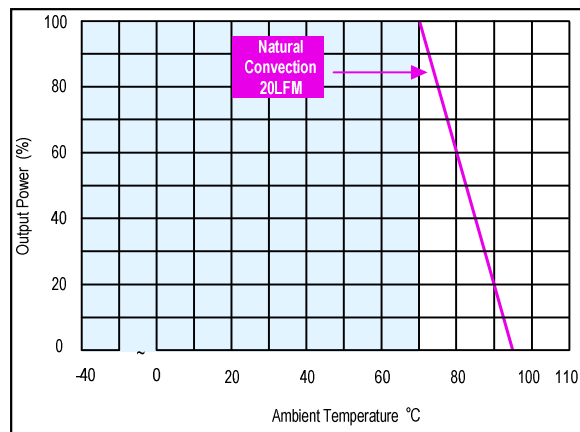

Figure 54: AYA00A12-L Derating Curve
 $V_{IN} = 12Vdc$

AYA00AA12-L Performance Curves

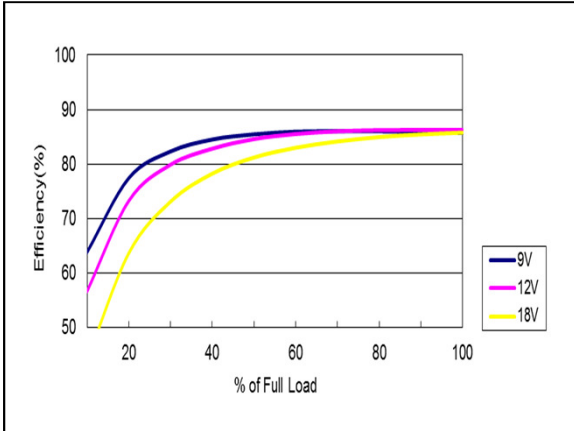

Figure 55: AYA00AA12-L Efficiency Versus Output Current Curve
 $V_{IN} = 9 \text{ to } 18\text{Vdc}$ Load: $I_o = 0.2\text{A}$

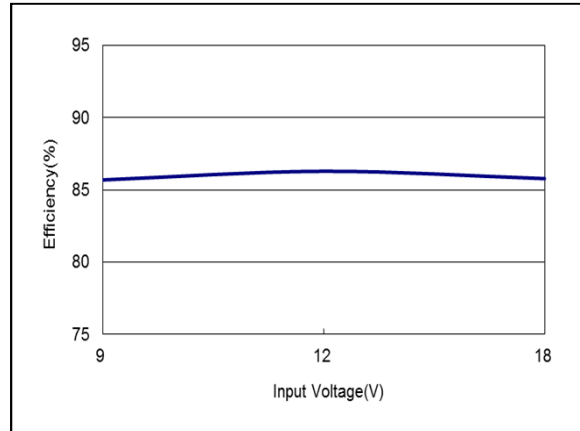

Figure 56: AYA00AA12-L Efficiency Versus Input Voltage Curve
 $V_{IN} = 9 \text{ to } 18\text{Vdc}$ Load: $I_o = 0.2\text{A}$

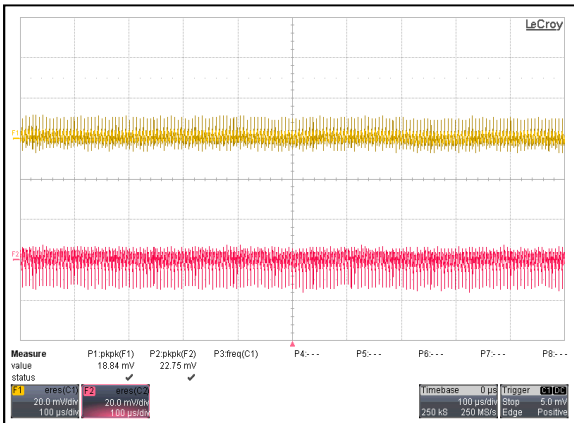

Figure 57: AYA00AA12-L Ripple and Noise Measurement
 $V_{IN} = 12\text{Vdc}$ Load: $I_o = 0.2\text{A}$
 Ch 1: V_{O1} Ch 2: V_{O2}

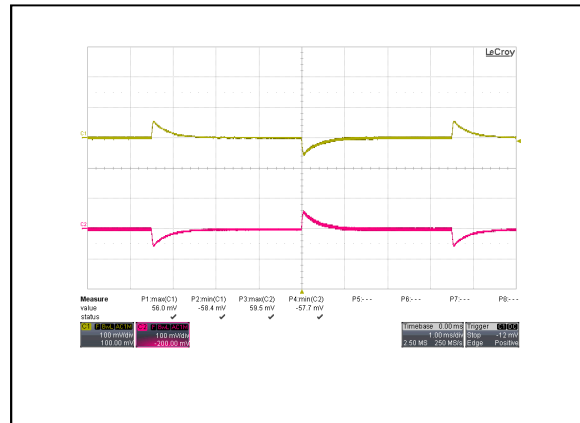

Figure 58: AYA00AA12-L Transient Response
 $V_{IN} = 12\text{Vdc}$ Load: $I_o = 100\%$ to 75% Load Change
 Ch 1: V_{O1} Ch 2: V_{O2}

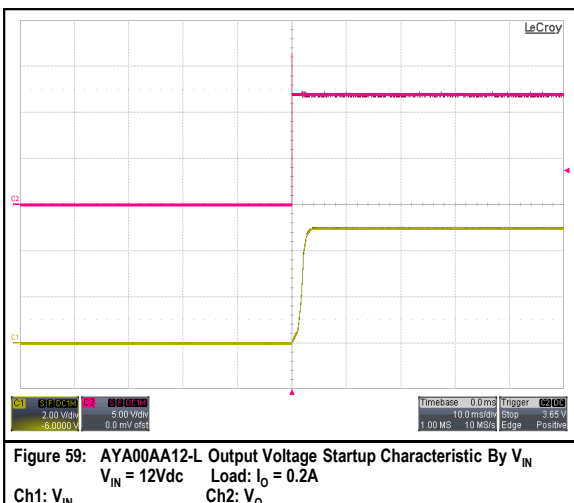

Figure 59: AYA00AA12-L Output Voltage Startup Characteristic By V_{IN}
 $V_{IN} = 12\text{Vdc}$ Load: $I_o = 0.2\text{A}$
 Ch 1: V_{IN} Ch 2: V_O

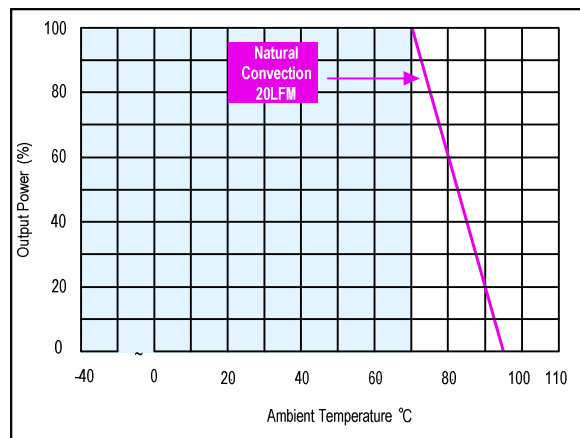

Figure 60: AYA00AA12-L Derating Curve
 $V_{IN} = 12\text{Vdc}$

AYA00B12-L Performance Curves

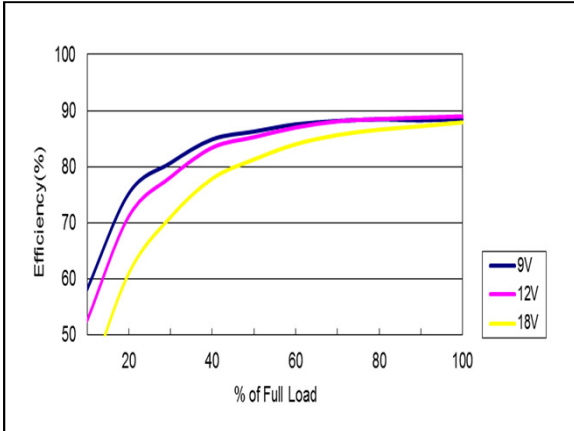

Figure 61: AYA00B12-L Efficiency Versus Output Current Curve
 $V_{IN} = 9 \text{ to } 18\text{Vdc}$ Load: $I_o = 0.167\text{A}$

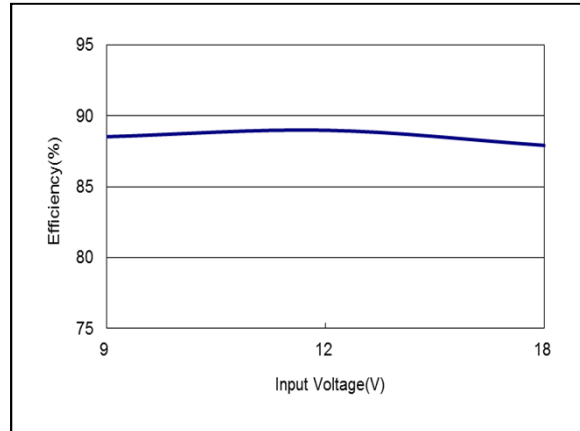

Figure 62: AYA00B12-L Efficiency Versus Input Voltage Curve
 $V_{IN} = 9 \text{ to } 18\text{Vdc}$ Load: $I_o = 0.167\text{A}$

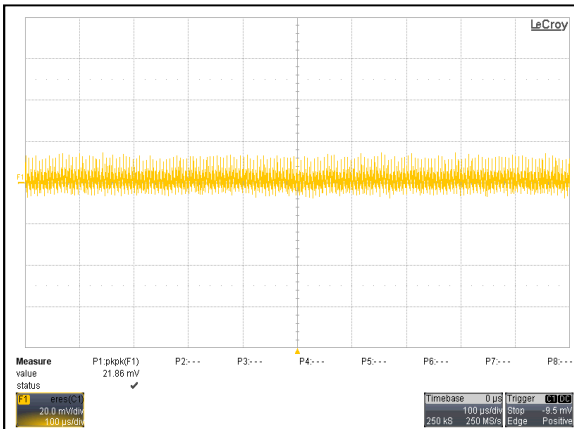

Figure 63: AYA00B12-L Ripple and Noise Measurement
 $V_{IN} = 12\text{Vdc}$ Load: $I_o = 0.167\text{A}$
 Ch 1: V_o

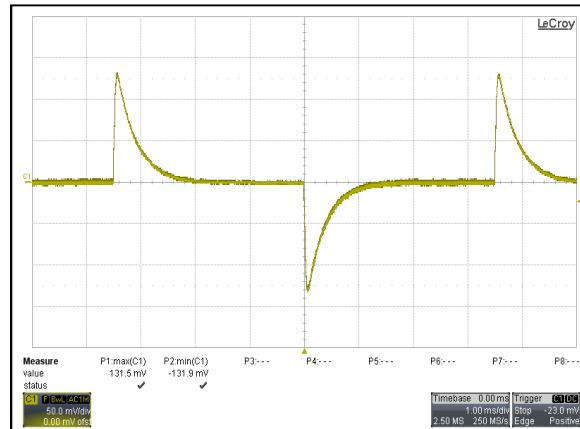

Figure 64: AYA00B12-L Transient Response
 $V_{IN} = 12\text{Vdc}$ Load: $I_o = 100\% \text{ to } 75\% \text{ Load Change}$
 Ch 1: V_o

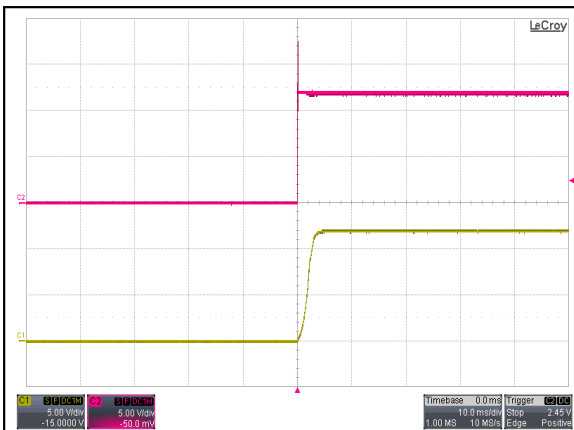

Figure 65: AYA00B12-L Output Voltage Startup Characteristic By V_{IN}
 $V_{IN} = 12\text{Vdc}$ Load: $I_o = 0.167\text{A}$
 Ch1: V_{IN} Ch2: V_o

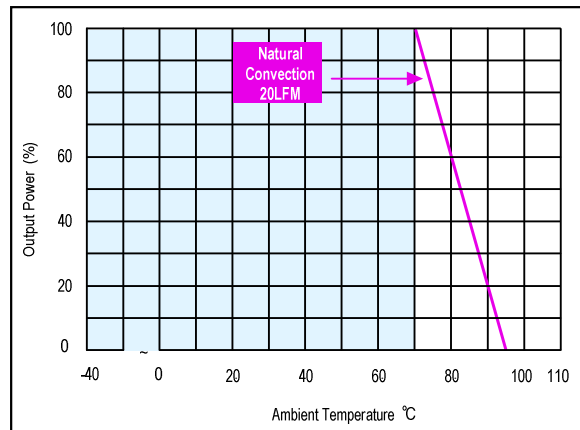

Figure 66: AYA00B12-L Derating Curve
 $V_{IN} = 12\text{Vdc}$

AYA00BB12-L Performance Curves

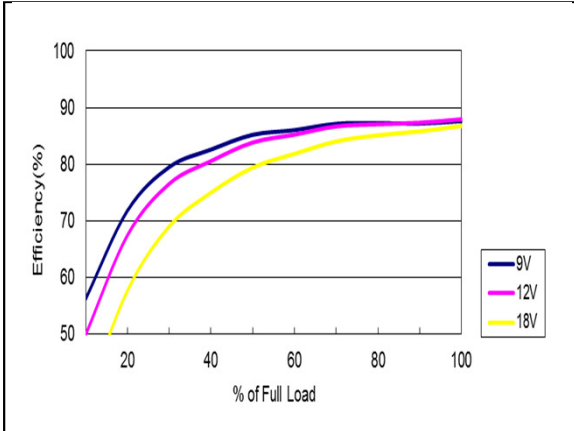

Figure 67: AYA00BB12-L Efficiency Versus Output Current Curve
 $V_{IN} = 9$ to 18Vdc Load: $I_o = 0.083A$

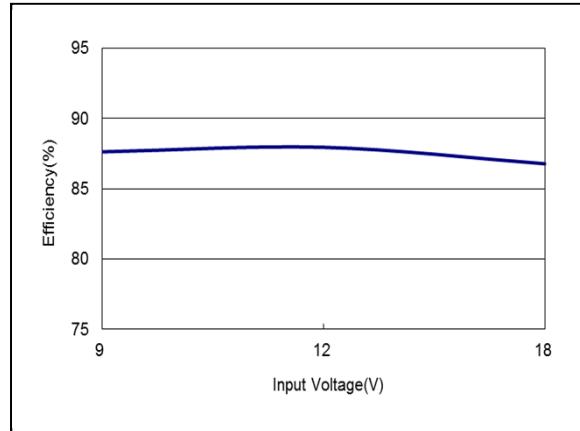

Figure 68: AYA00BB12-L Efficiency Versus Input Voltage Curve
 $V_{IN} = 9$ to 18Vdc Load: $I_o = 0.083A$

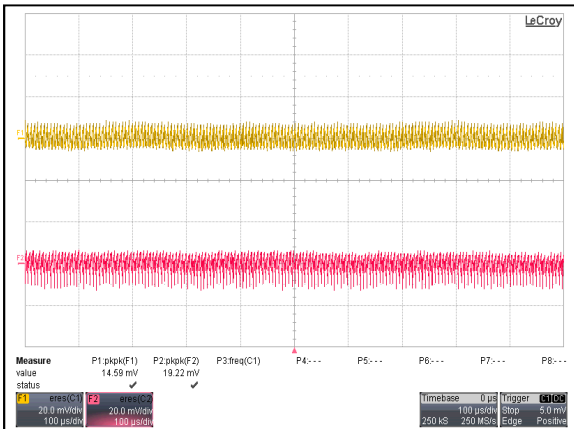

Figure 69: AYA00BB12-L Ripple and Noise Measurement
 $V_{IN} = 12Vdc$ Load: $I_o = 0.083A$
 Ch 1: V_{O1} Ch 2: V_{O2}

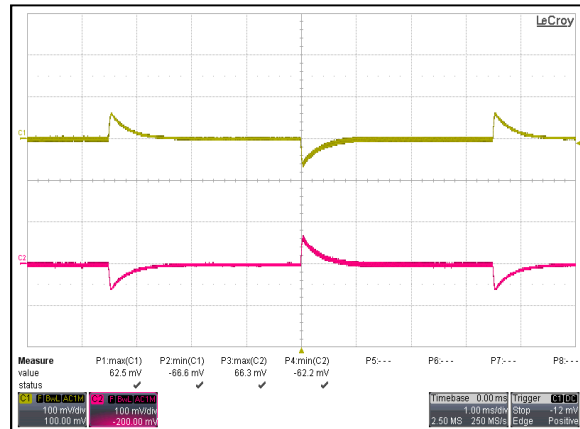

Figure 70: AYA00BB12-L Transient Response
 $V_{IN} = 12Vdc$ Load: $I_o = 100\%$ to 75% Load Change
 Ch 1: V_{O1} Ch 2: V_{O2}

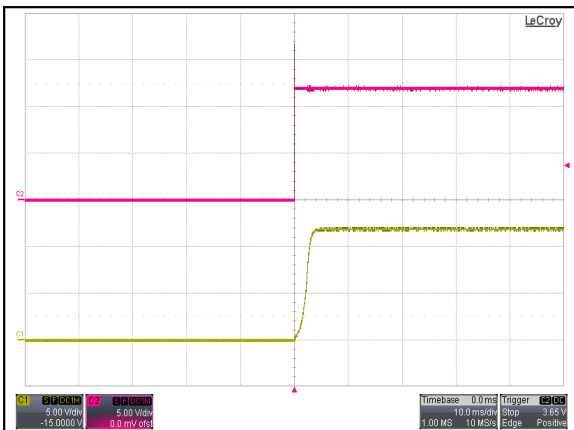

Figure 71: AYA00BB12-L Output Voltage Startup Characteristic By V_{IN}
 $V_{IN} = 12Vdc$ Load: $I_o = 0.083A$
 Ch 1: V_{IN} Ch 2: V_O

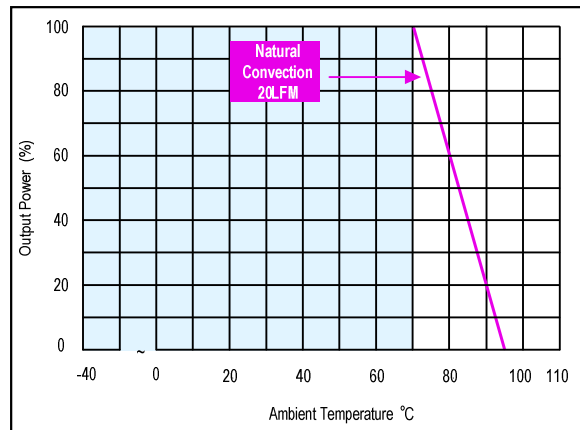

Figure 72: AYA00BB12-L Derating Curve
 $V_{IN} = 12Vdc$

AYA00C12-L Performance Curves

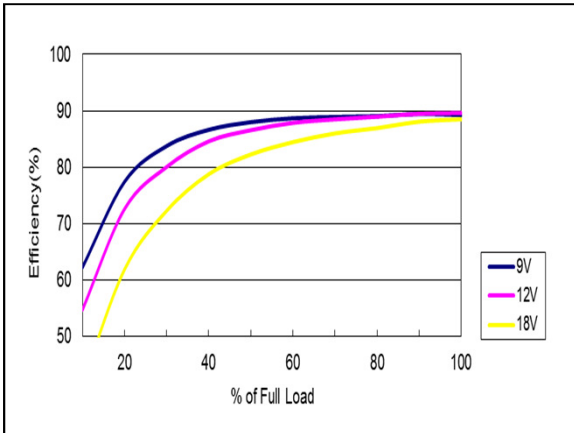

Figure 73: AYA00C12-L Efficiency Versus Output Current Curve
 $V_{IN} = 9$ to 18Vdc Load: $I_o = 0.134A$

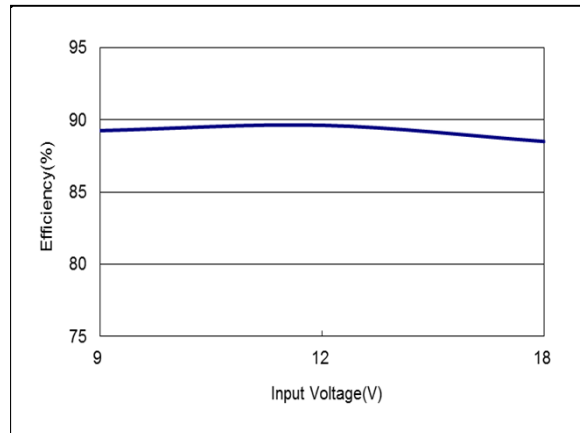

Figure 74: AYA00C12-L Efficiency Versus Input Voltage Curve
 $V_{IN} = 9$ to 18Vdc Load: $I_o = 0.134A$

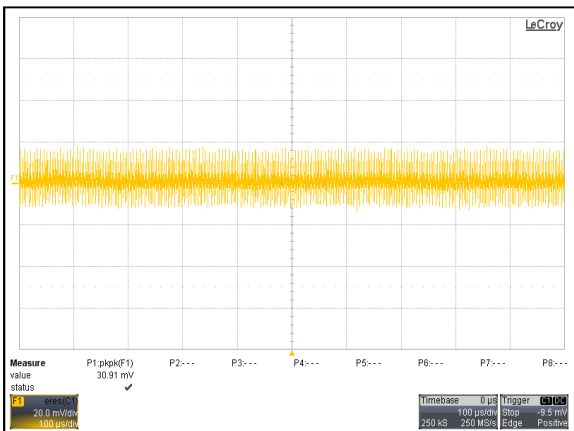

Figure 75: AYA00C12-L Ripple and Noise Measurement
 $V_{IN} = 12Vdc$ Load: $I_o = 0.134A$
 Ch 1: V_o

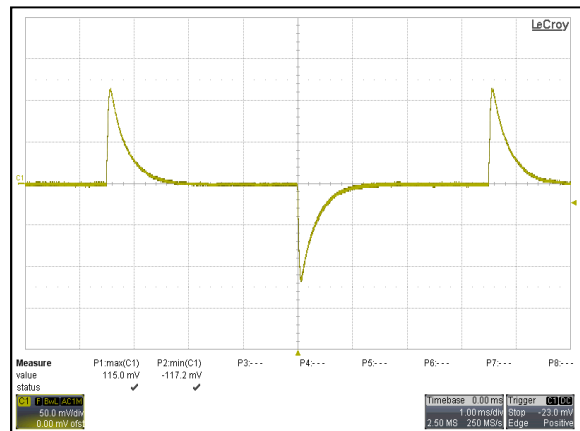

Figure 76: AYA00C12-L Transient Response
 $V_{IN} = 12Vdc$ Load: $I_o = 100\%$ to 75% Load Change
 Ch 1: V_o

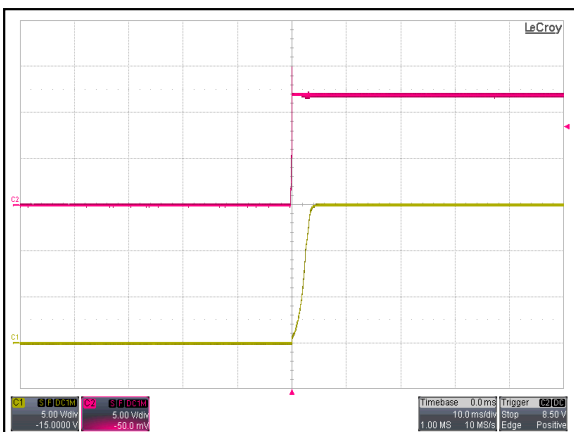

Figure 77: AYA00C12-L Output Voltage Startup Characteristic By V_{IN}
 $V_{IN} = 12Vdc$ Load: $I_o = 0.134A$
 Ch1: V_{IN} Ch2: V_o

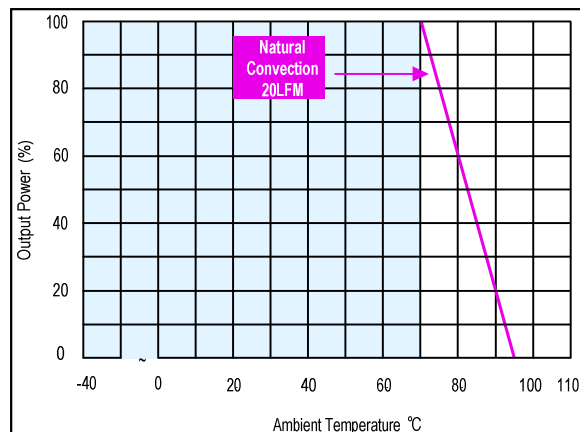

Figure 78: AYA00C12-L Derating Curve
 $V_{IN} = 12Vdc$

AYA00CC12-L Performance Curves

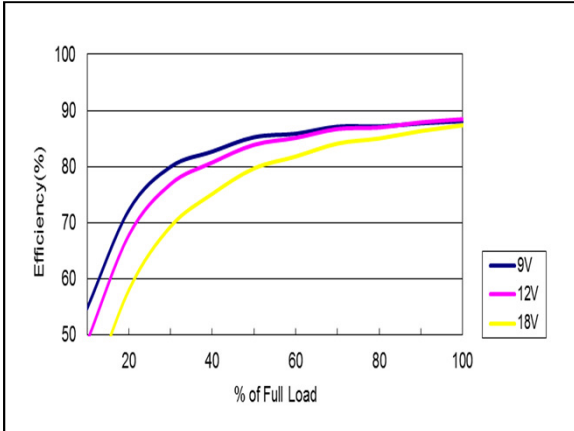

Figure 79: AYA00CC12-L Efficiency Versus Output Current Curve
 $V_{IN} = 9$ to 18Vdc Load: $I_o = 0.067A$

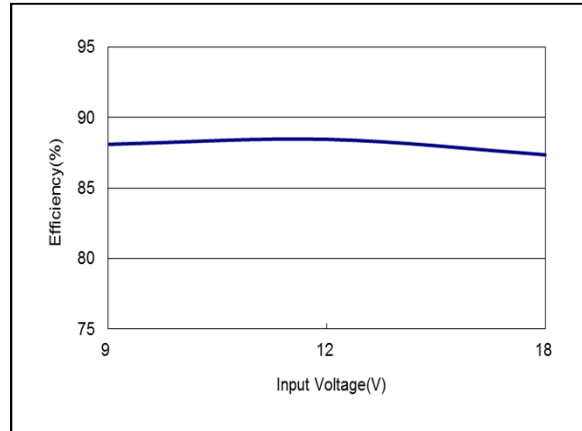

Figure 80: AYA00CC12-L Efficiency Versus Input Voltage Curve
 $V_{IN} = 9$ to 18Vdc Load: $I_o = 0.067A$

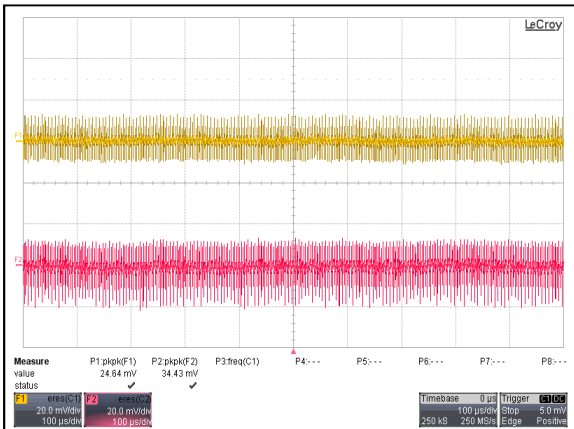

Figure 81: AYA00CC12-L Ripple and Noise Measurement
 $V_{IN} = 12Vdc$ Load: $I_o = 0.067A$
 Ch 1: V_{O1} Ch 2: V_{O2}

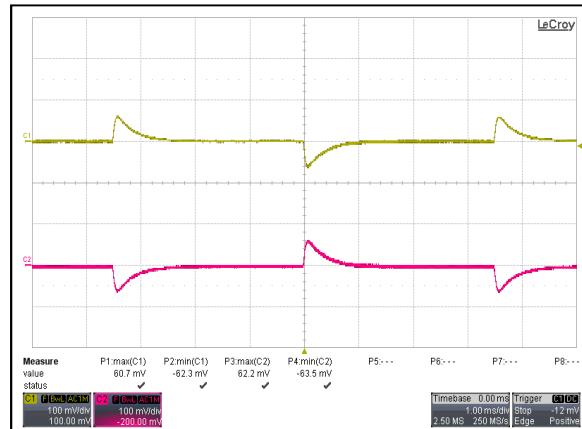

Figure 82: AYA00CC12-L Transient Response
 $V_{IN} = 12Vdc$ Load: $I_o = 100\%$ to 75% Load Change
 Ch 1: V_{O1} Ch 2: V_{O2}

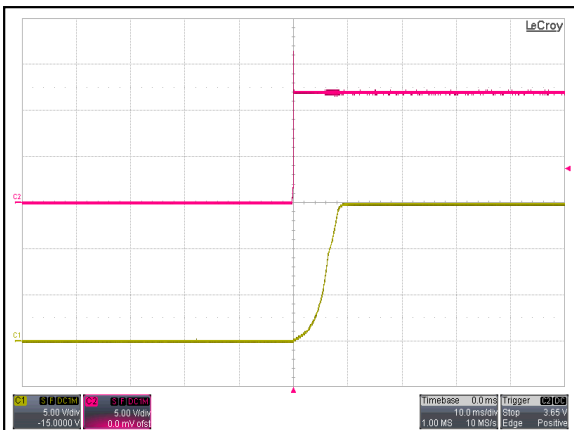

Figure 83: AYA00CC12-L Output Voltage Startup Characteristic By V_{IN}
 $V_{IN} = 12Vdc$ Load: $I_o = 0.067A$
 Ch1: V_{IN} Ch2: V_O

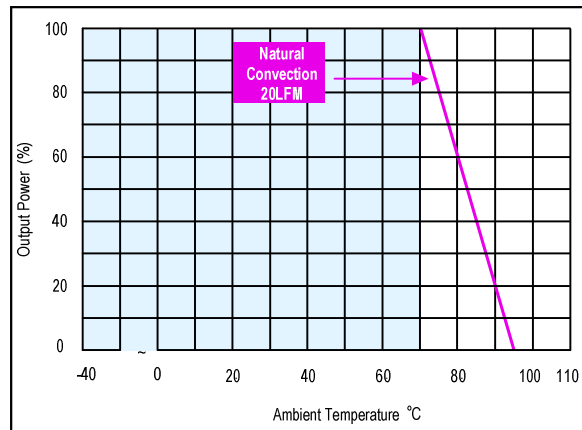

Figure 84: AYA00CC12-L Derating Curve
 $V_{IN} = 12Vdc$

AYA00F24-L Performance Curves

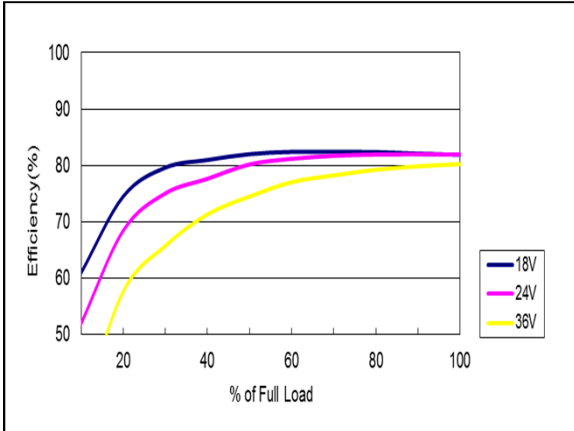

Figure 85: AYA00F24-L Efficiency Versus Output Current Curve
 $V_{IN} = 18$ to $36V_{dc}$ Load: $I_o = 0$ to $0.4A$

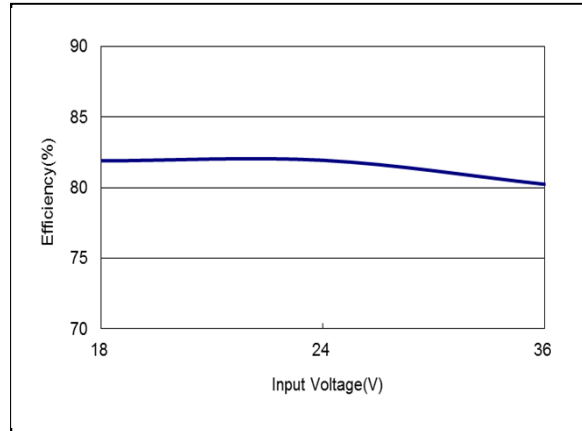

Figure 86: AYA00F24-L Efficiency Versus Input Voltage Curve
 $V_{IN} = 18$ to $36V_{dc}$ Load: $I_o = 0.4A$

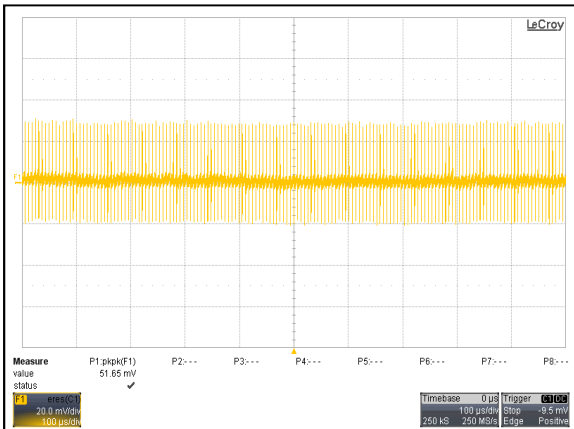

Figure 87: AYA00F24-L Ripple and Noise Measurement
 $V_{IN} = 24V_{dc}$ Load: $I_o = 0.4A$
 Ch 1: V_o

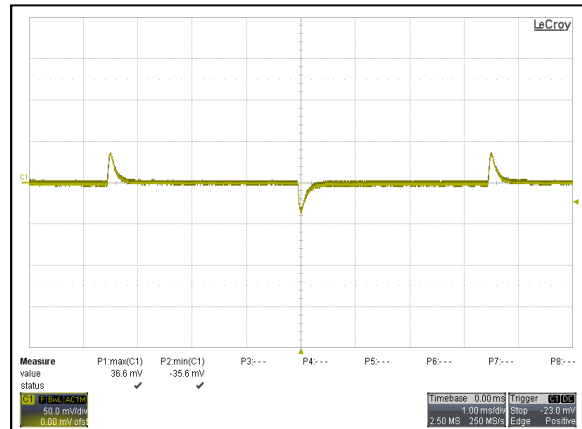

Figure 88: AYA00F24-L Transient Response
 $V_{IN} = 24V_{dc}$ Load: $I_o = 100\%$ to 75% Load Change
 Ch 1: V_o

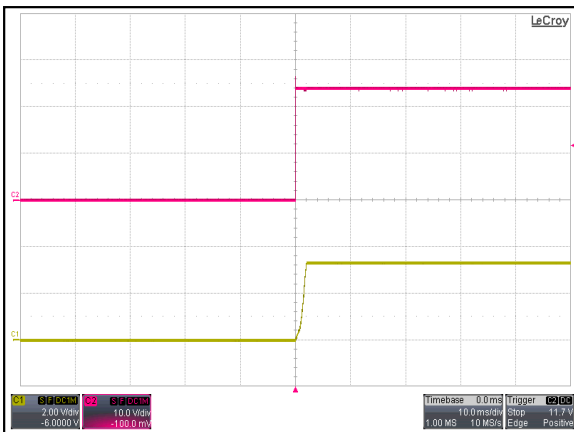

Figure 89: AYA00F24-L Output Voltage Startup Characteristic By V_{IN}
 $V_{IN} = 24V_{dc}$ Load: $I_o = 0.4A$
 Ch1: V_{IN} Ch2: V_o

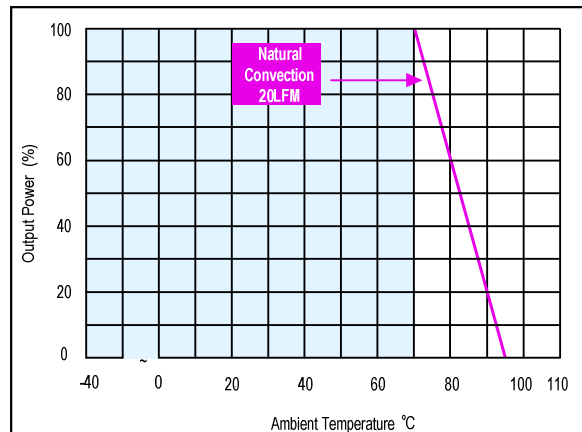

Figure 90: AYA00F24-L Derating Curve
 $V_{IN} = 24V_{dc}$

AYA00A24-L Performance Curves

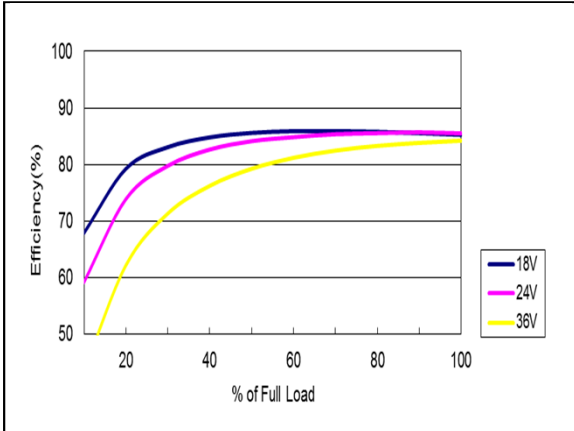

Figure 91: AYA00A24-L Efficiency Versus Output Current Curve
 $V_{IN} = 18$ to $36Vdc$ Load: $I_o = 0$ to $0.4A$

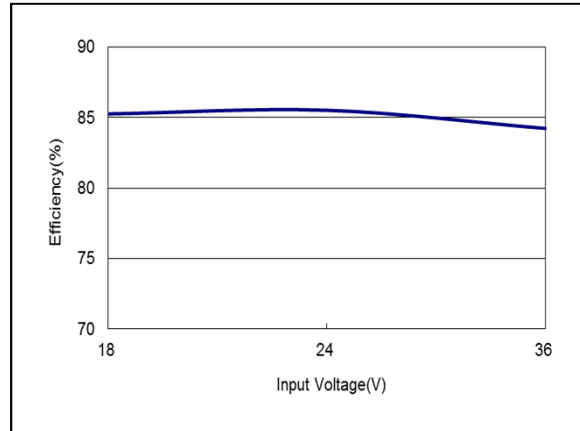

Figure 92: AYA00A24-L Efficiency Versus Input Voltage Curve
 $V_{IN} = 18$ to $36Vdc$ Load: $I_o = 0.4A$

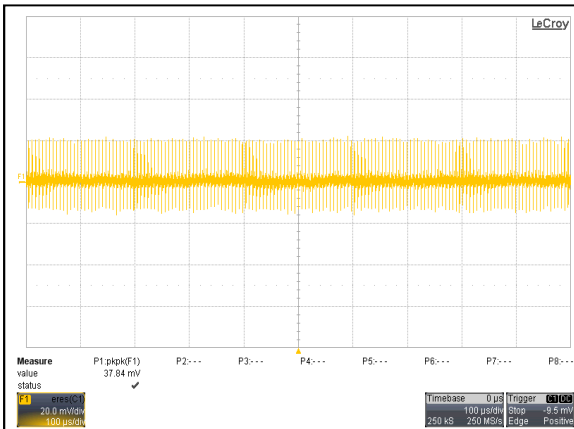

Figure 93: AYA00A24-L Ripple and Noise Measurement
 $V_{IN} = 24Vdc$ Load: $I_o = 0.4A$
 Ch 1: V_o

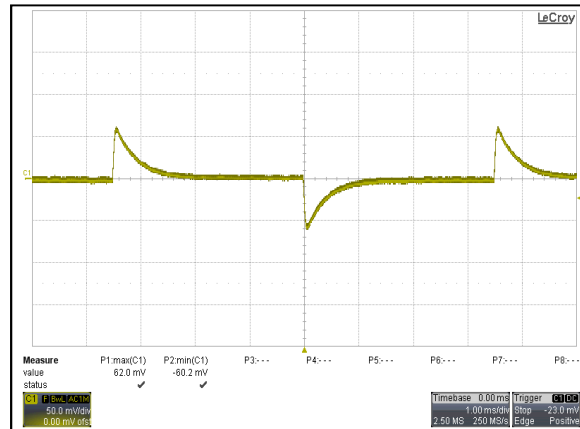

Figure 94: AYA00A24-L Transient Response
 $V_{IN} = 24Vdc$ Load: $I_o = 100\%$ to 75% Load Change
 Ch 1: V_o

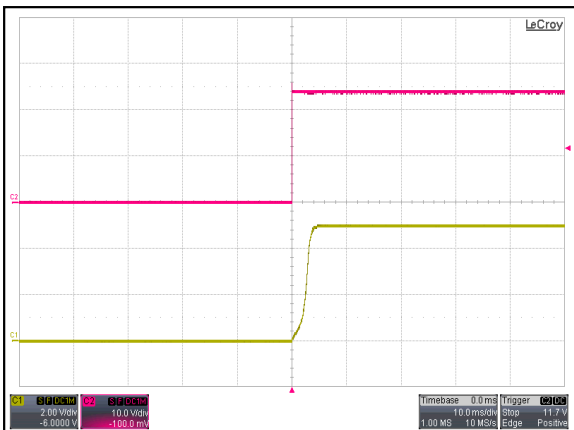

Figure 95: AYA00A24-L Output Voltage Startup Characteristic By V_{IN}
 $V_{IN} = 24Vdc$ Load: $I_o = 0.4A$
 Ch1: V_{IN} Ch2: V_o

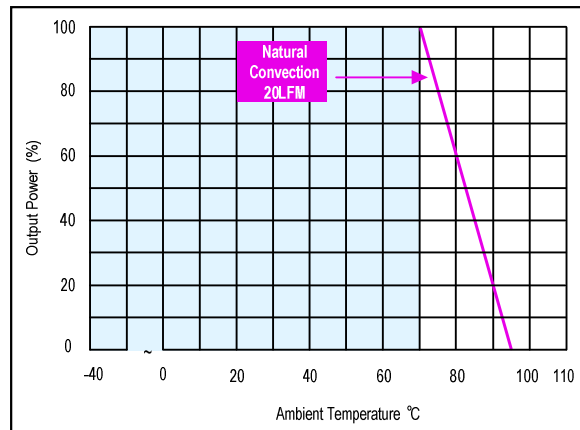

Figure 96: AYA00A24-L Derating Curve
 $V_{IN} = 24Vdc$

AYA00AA24-L Performance Curves

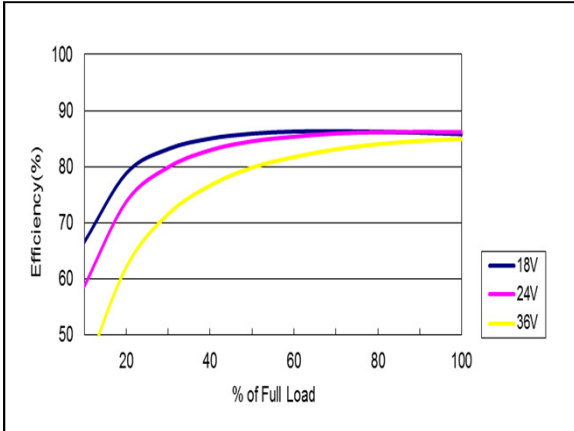

Figure 97: AYA00AA24-L Efficiency Versus Output Current Curve
 $V_{IN} = 18$ to $36Vdc$ Load: $I_o = 0$ to $0.2A$

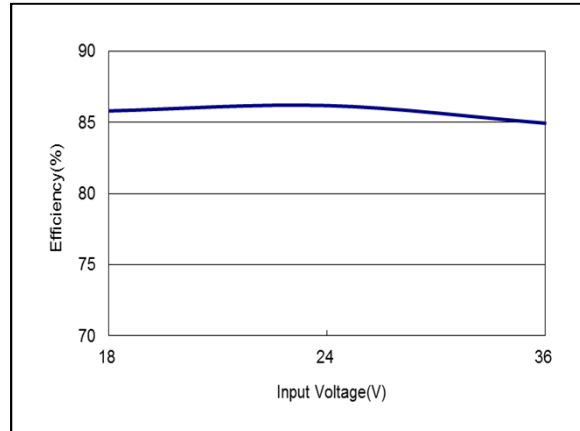

Figure 98: AYA00AA24-L Efficiency Versus Input Voltage Curve
 $V_{IN} = 18$ to $36Vdc$ Load: $I_o = 0.2A$

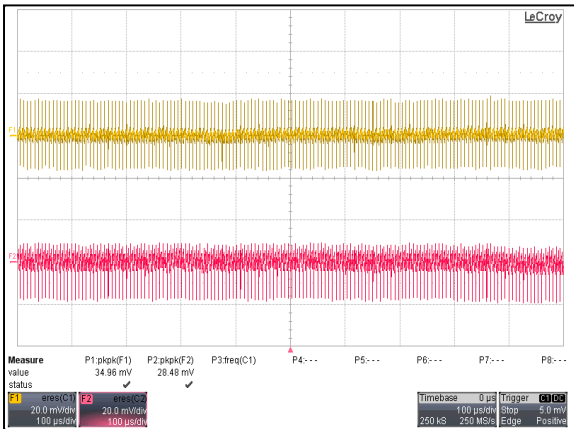

Figure 99: AYA00AA24-L Ripple and Noise Measurement
 $V_{IN} = 24Vdc$ Load: $I_o = 0.2A$
 Ch 1: V_{O1} Ch 2: V_{O2}

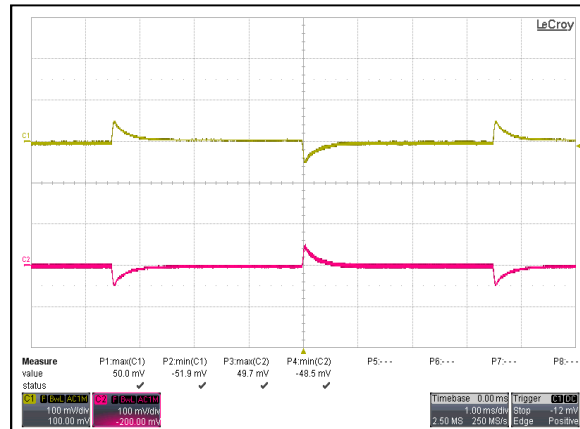

Figure 100: AYA00AA24-L Transient Response
 $V_{IN} = 24Vdc$ Load: $I_o = 100\%$ to 75% Load Change
 Ch 1: V_{O1} Ch 2: V_{O2}

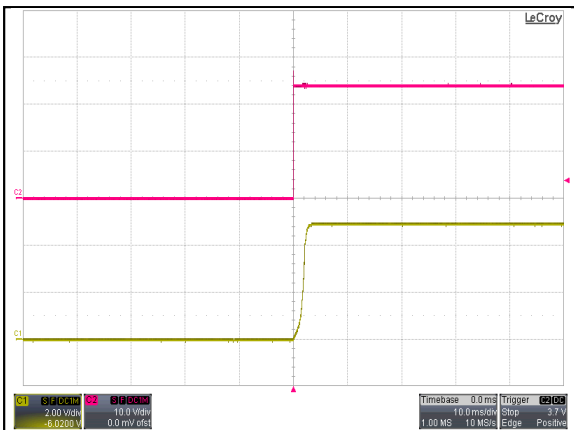

Figure 101: AYA00AA24-L Output Voltage Startup Characteristic By V_{IN}
 $V_{IN} = 24Vdc$ Load: $I_o = 0.2A$
 Ch1: V_{IN} Ch2: V_O

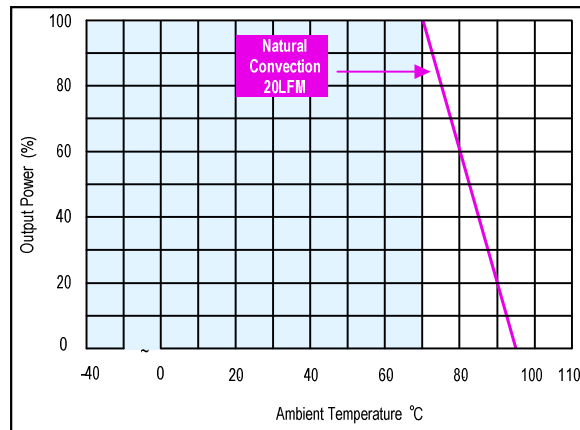

Figure 102: AYA00AA24-L Derating Curve
 $V_{IN} = 24Vdc$

AYA00B24-L Performance Curves

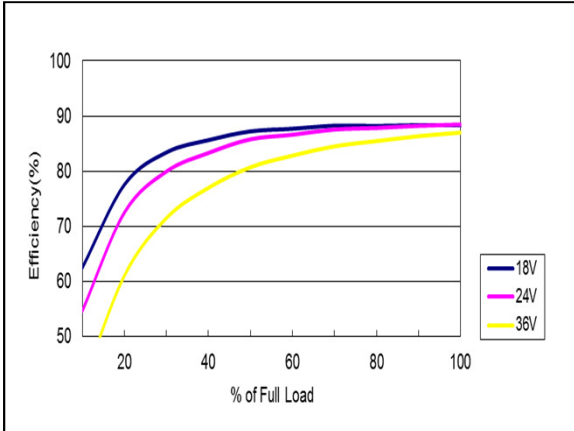

Figure 103: AYA00B24-L Efficiency Versus Output Current Curve
 $V_{IN} = 18$ to $36Vdc$ Load: $I_O = 0$ to $0.167A$

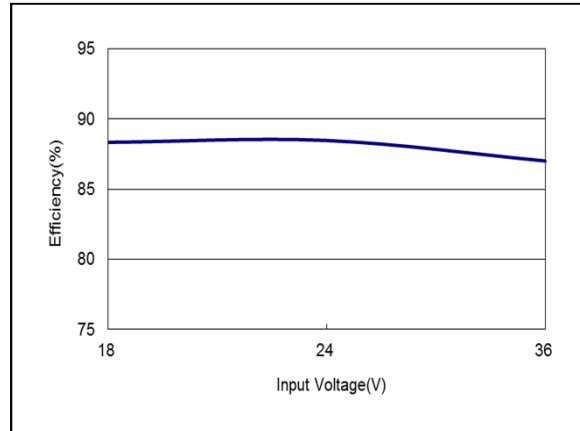

Figure 104: AYA00B24-L Efficiency Versus Input Voltage Curve
 $V_{IN} = 18$ to $36Vdc$ Load: $I_O = 0.167A$

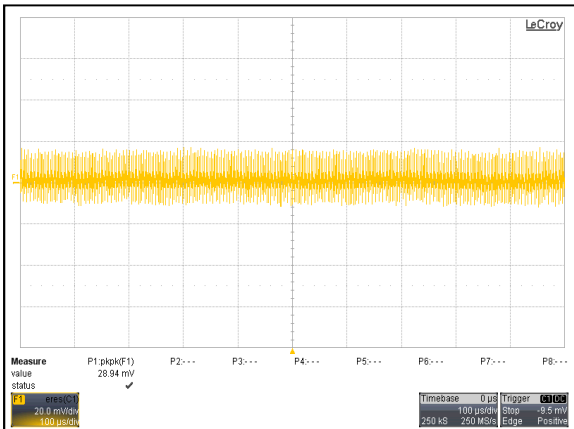

Figure 105: AYA00B24-L Ripple and Noise Measurement
 $V_{IN} = 24Vdc$ Load: $I_O = 0.167A$
 Ch 1: V_O

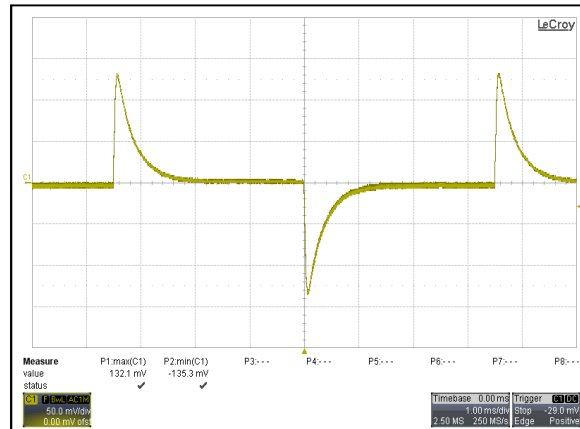

Figure 106: AYA00B24-L Transient Response
 $V_{IN} = 24Vdc$ Load: $I_O = 100\%$ to 75% Load Change
 Ch 1: V_O

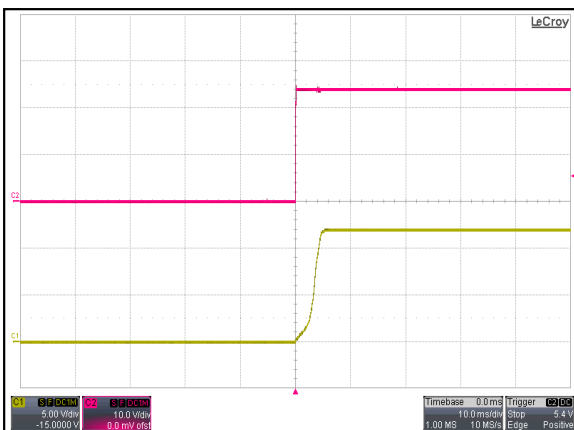

Figure 107: AYA00B24-L Output Voltage Startup Characteristic By V_{IN}
 $V_{IN} = 24Vdc$ Load: $I_O = 0.167A$
 Ch1: V_{IN} Ch2: V_O

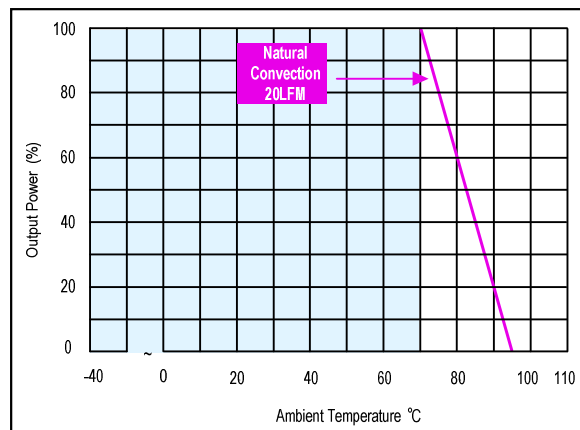

Figure 108: AYA00B24-L Derating Curve
 $V_{IN} = 24Vdc$

AYA00BB24-L Performance Curves

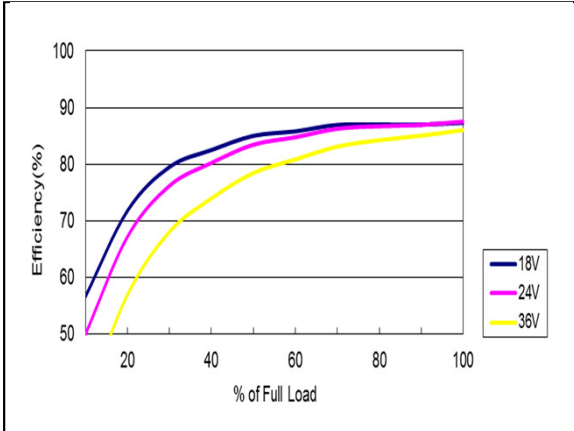

Figure 109: AYA00BB24-L Efficiency Versus Output Current Curve
 $V_{IN} = 18$ to $36Vdc$ Load: $I_o = 0.083A$

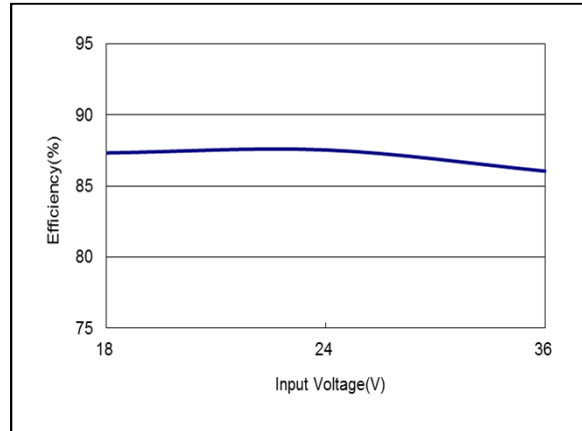

Figure 110: AYA00BB24-L Efficiency Versus Input Voltage Curve
 $V_{IN} = 18$ to $36Vdc$ Load: $I_o = 0.083A$

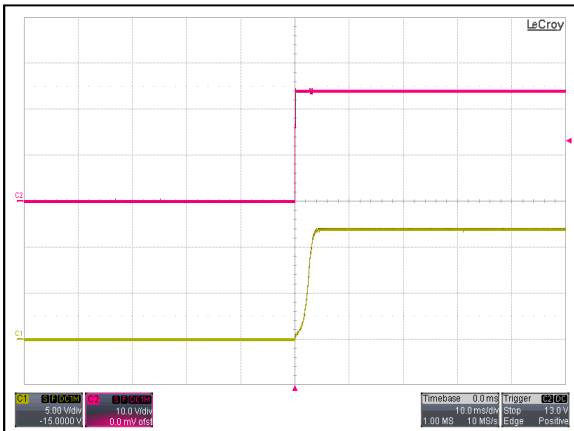

Figure 111: AYA00BB24-L Ripple and Noise Measurement
 $V_{IN} = 24Vdc$ Load: $I_o = 0.083A$
 Ch 1: V_{O1} Ch 2: V_{O2}

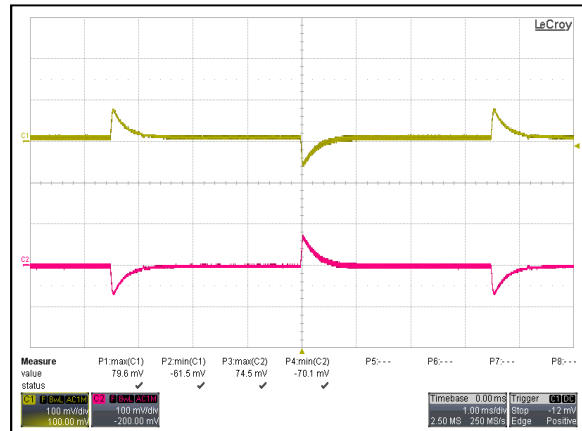

Figure 112: AYA00BB24-L Transient Response
 $V_{IN} = 24Vdc$ Load: $I_o = 100\%$ to 75% Load Change
 Ch 1: V_{O1} Ch 2: V_{O2}

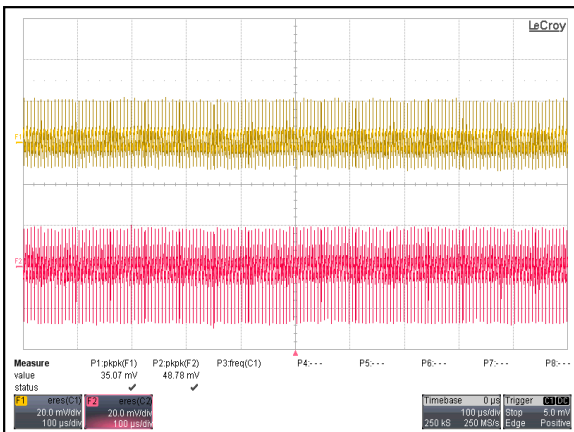

Figure 113: AYA00BB24-L Output Voltage Startup Characteristic By V_{IN}
 $V_{IN} = 24Vdc$ Load: $I_o = 0.083A$
 Ch 1: V_{IN} Ch 2: V_O

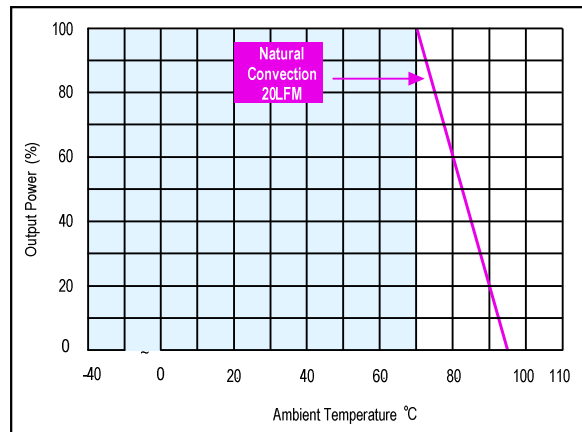

Figure 114: AYA00BB24-L Derating Curve
 $V_{IN} = 24Vdc$

AYA00C24-L Performance Curves

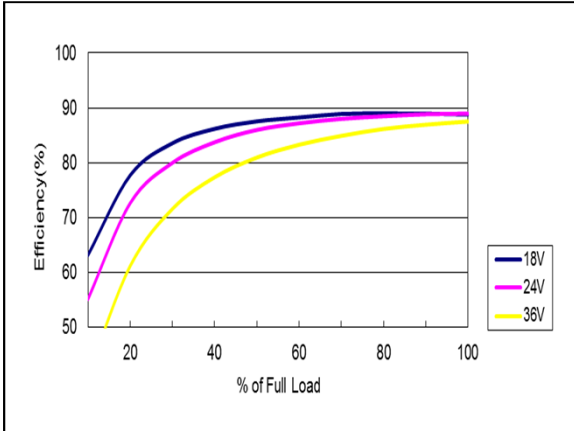

Figure 115: AYA00C24-L Efficiency Versus Output Current Curve
 $V_{IN} = 18$ to $36Vdc$ Load: $I_O = 0.134A$

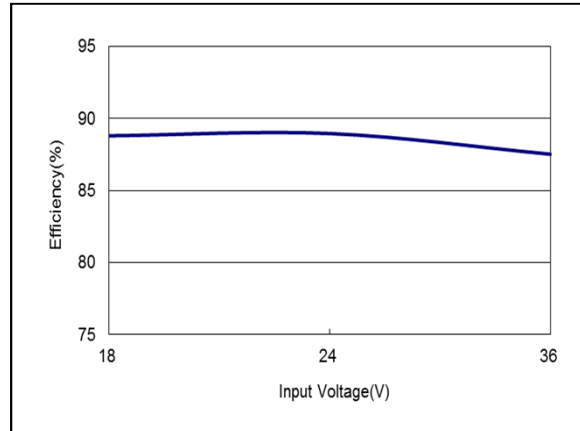

Figure 116: AYA00C24-L Efficiency Versus Input Voltage Curve
 $V_{IN} = 18$ to $36Vdc$ Load: $I_O = 0.134A$

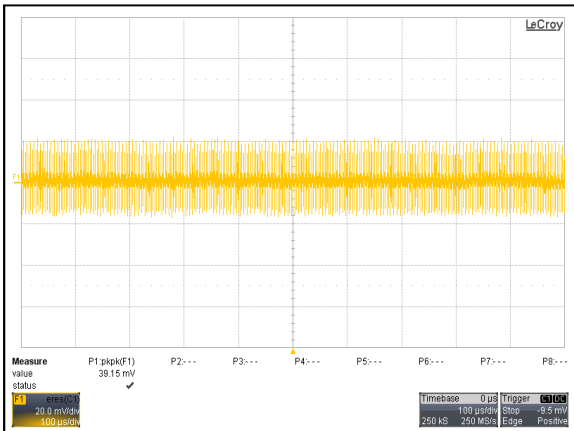

Figure 117: AYA00C24-L Ripple and Noise Measurement
 $V_{IN} = 24Vdc$ Load: $I_O = 0.134A$
 Ch 1: V_O

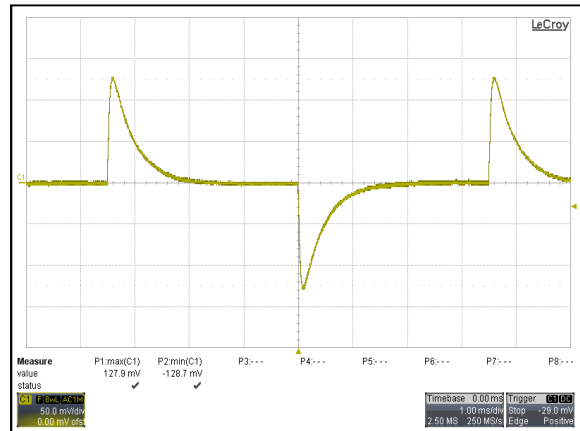

Figure 118: AYA00C24-L Transient Response
 $V_{IN} = 24Vdc$ Load: $I_O = 100\%$ to 75% Load Change
 Ch 1: V_O

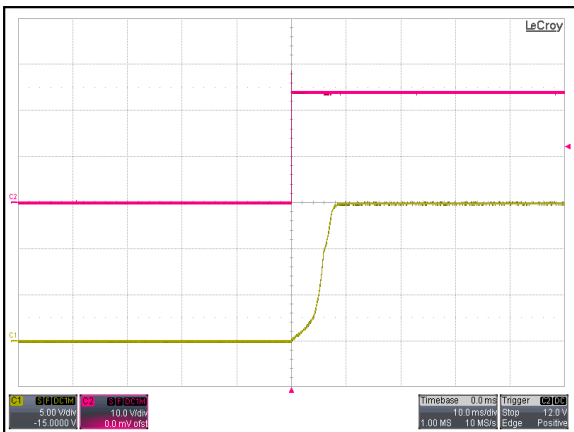

Figure 119: AYA00C24-L Output Voltage Startup Characteristic By V_{IN}
 $V_{IN} = 24Vdc$ Load: $I_O = 0.134A$
 Ch3: V_{IN} Ch1: V_O

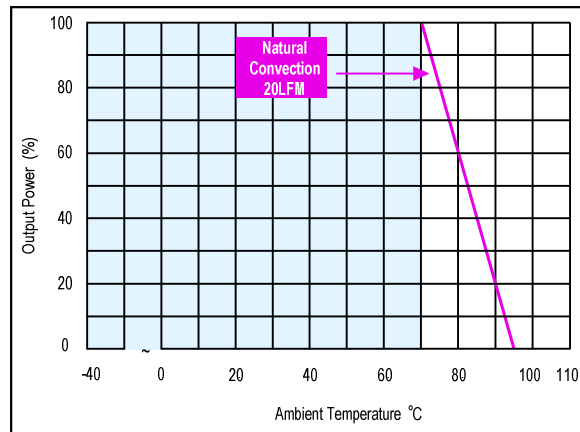

Figure 120: AYA00C24-L Derating Curve
 $V_{IN} = 24Vdc$

AYA00CC24-L Performance Curves

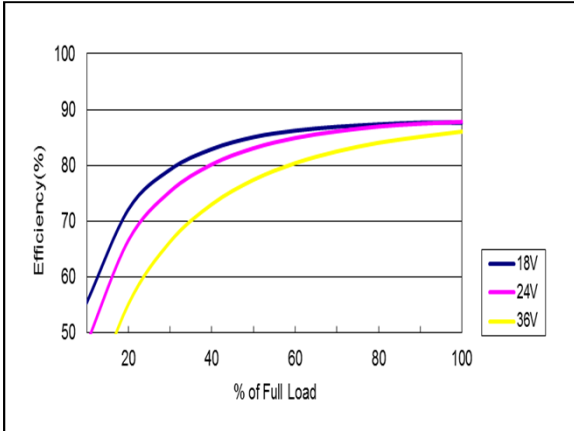

Figure 121: AYA00CC24-L Efficiency Versus Output Current Curve
 $V_{IN} = 18$ to $36Vdc$ Load: $I_o = 0.067A$

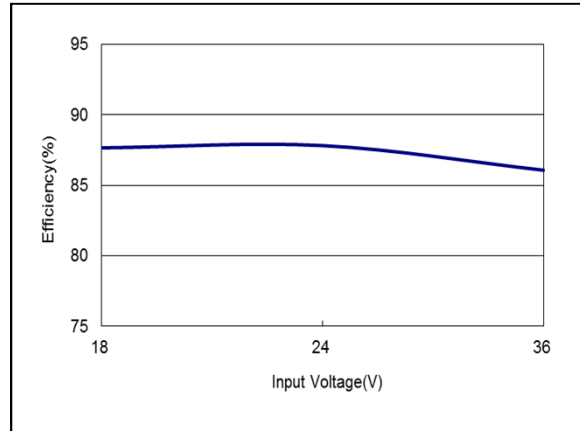

Figure 122: AYA00CC24-L Efficiency Versus Input Voltage Curve
 $V_{IN} = 18$ to $36Vdc$ Load: $I_o = 0.067A$

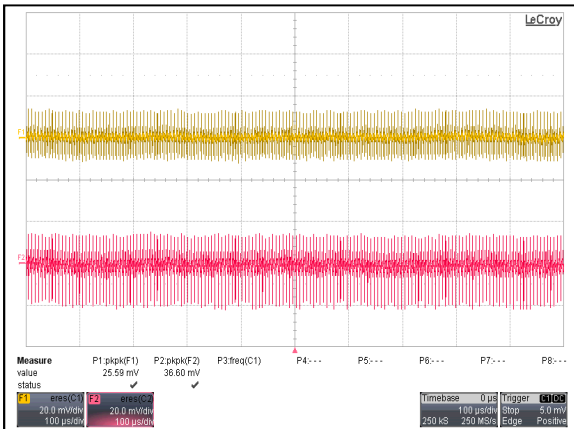

Figure 123: AYA00CC24-L Ripple and Noise Measurement
 $V_{IN} = 24Vdc$ Load: $I_o = 0.067A$
 Ch 1: V_{O1} Ch 2: V_{O2}

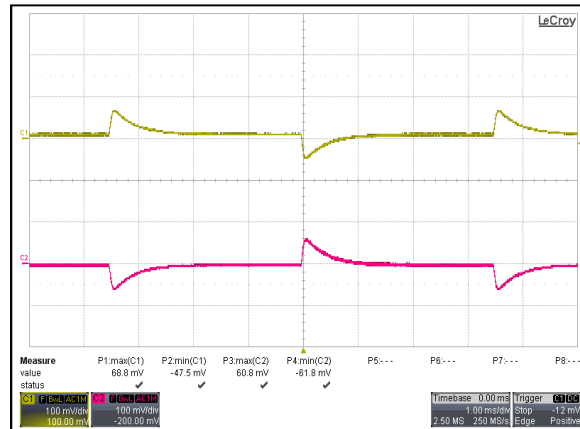

Figure 124: AYA00CC24-L Transient Response
 $V_{IN} = 24Vdc$ Load: $I_o = 100\%$ to 75% Load Change
 Ch 1: V_{O1} Ch 2: V_{O2}

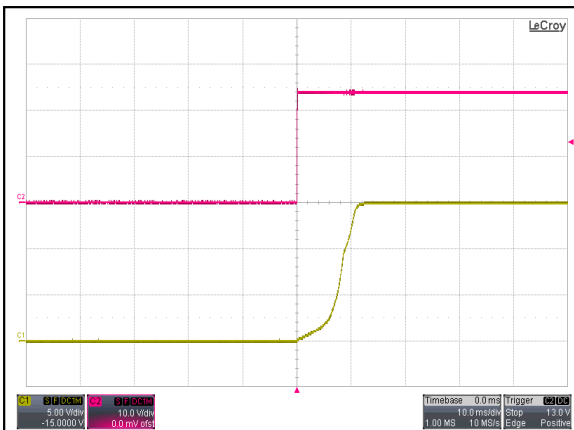

Figure 125: AYA00CC24-L Output Voltage Startup Characteristic By V_{IN}
 $V_{IN} = 24Vdc$ Load: $I_o = 0.067A$
 Ch1: V_{IN} Ch2: V_O

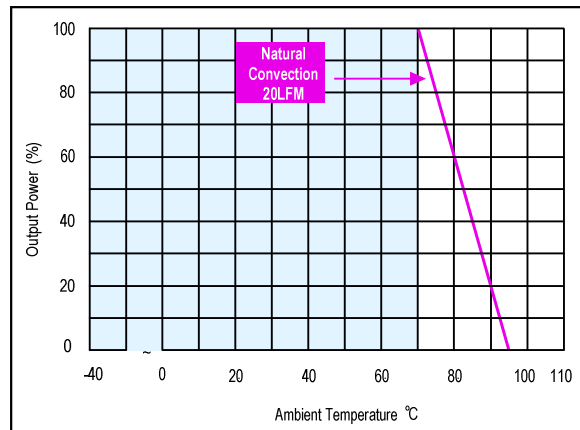

Figure 126: AYA00CC24-L Derating Curve
 $V_{IN} = 24Vdc$

AYA00F48-L Performance Curves

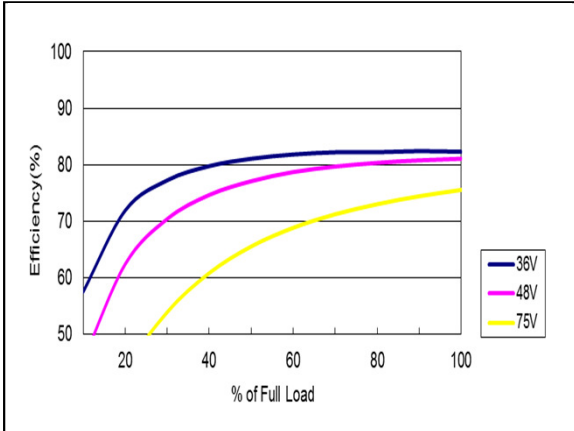

Figure 127: AYA00F48-L Efficiency Versus Output Current Curve
 $V_{IN} = 36$ to $75Vdc$ Load: $I_o = 0$ to $0.4A$

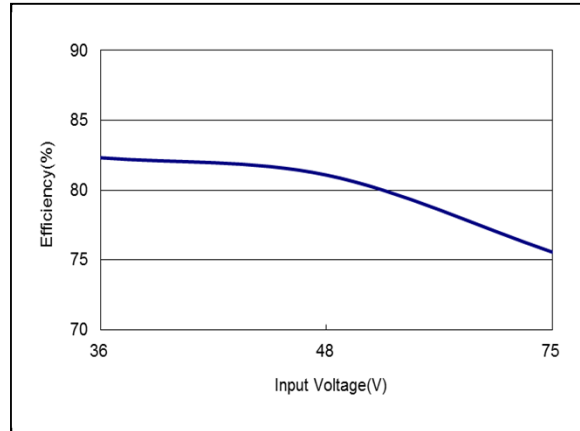

Figure 128: AYA00F48-L Efficiency Versus Input Voltage Curve
 $V_{IN} = 36$ to $75Vdc$ Load: $I_o = 0.4A$

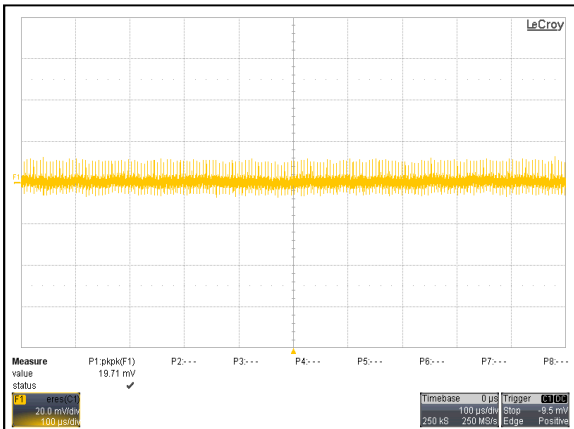

Figure 129: AYA00F48-L Ripple and Noise Measurement
 $V_{IN} = 48Vdc$ Load: $I_o = 0.4A$
 Ch 1: V_o

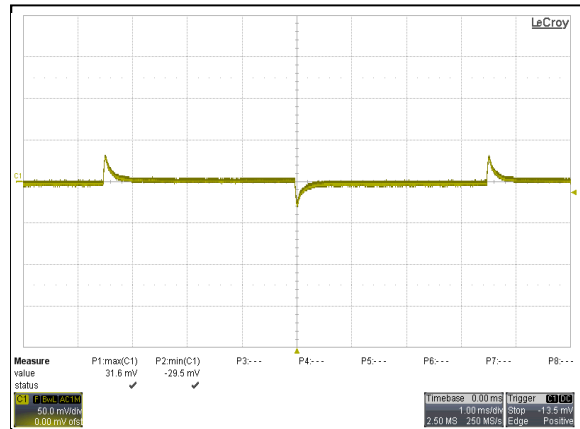

Figure 130: AYA00F48-L Transient Response
 $V_{IN} = 48Vdc$ Load: $I_o = 100\%$ to 75% Load Change
 Ch 1: V_o

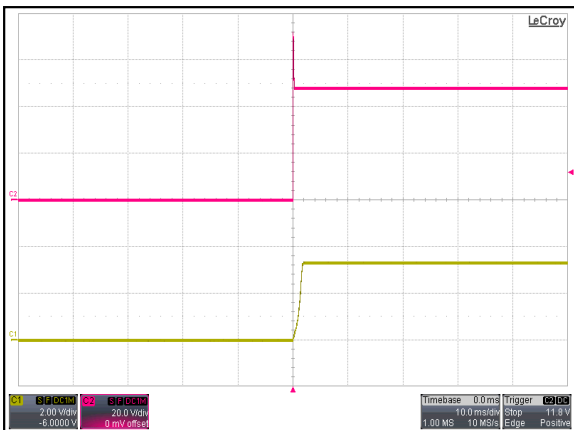

Figure 131: AYA00F48-L Output Voltage Startup Characteristic By V_{IN}
 $V_{IN} = 48Vdc$ Load: $I_o = 0.4A$
 Ch1: V_{IN} Ch2: V_o

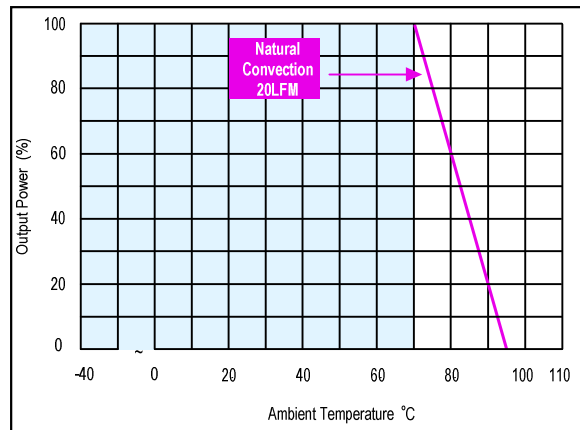

Figure 132: AYA00F48-L Derating Curve
 $V_{IN} = 48Vdc$

AYA00A48-L Performance Curves

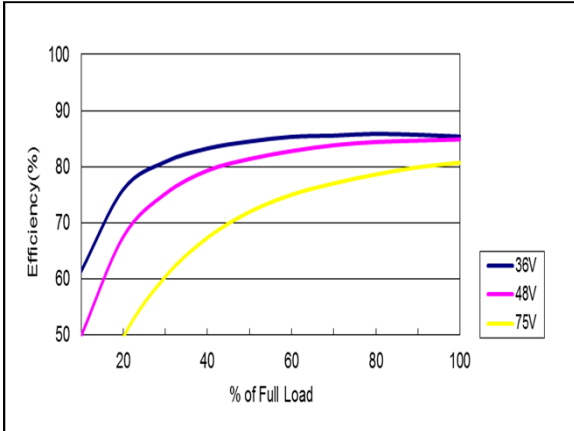

Figure 133: AYA00A48-L Efficiency Versus Output Current Curve
 $V_{IN} = 36$ to 75 Vdc Load: $I_O = 0$ to 0.4 A

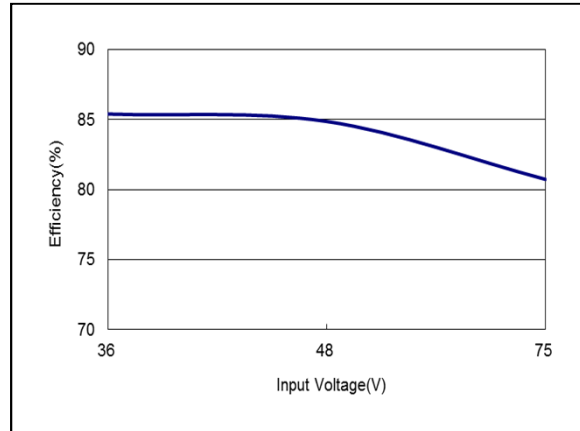

Figure 134: AYA00A48-L Efficiency Versus Input Voltage Curve
 $V_{IN} = 36$ to 75 Vdc Load: $I_O = 0.4$ A

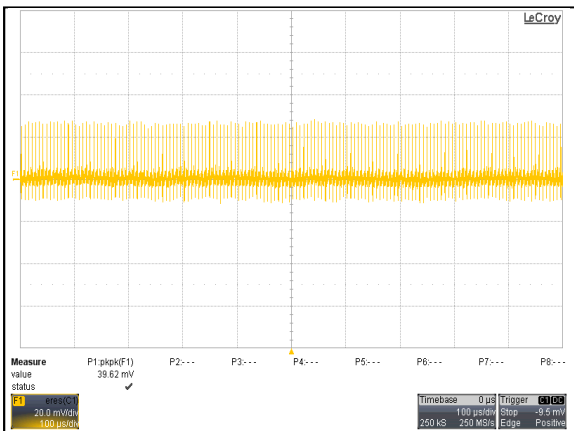

Figure 135: AYA00A48-L Ripple and Noise Measurement
 $V_{IN} = 48$ Vdc Load: $I_O = 0.4$ A
 Ch 1: V_O

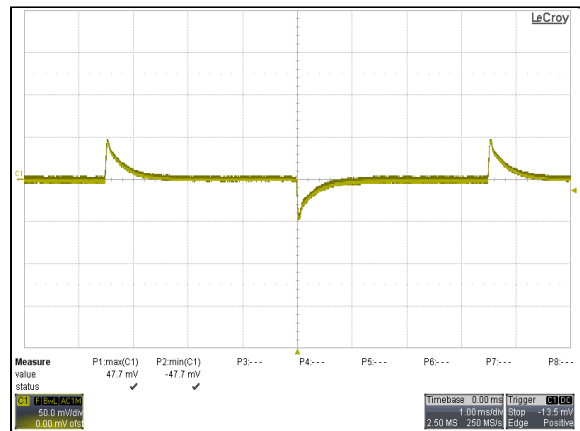

Figure 136: AYA00A48-L Transient Response
 $V_{IN} = 48$ Vdc Load: $I_O = 100\%$ to 75% Load Change
 Ch 1: V_O

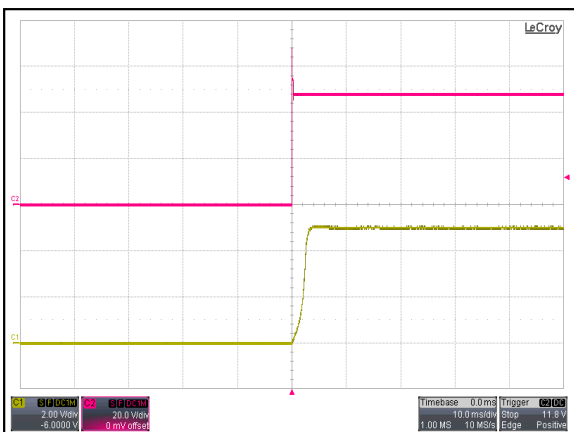

Figure 137: AYA00A48-L Output Voltage Startup Characteristic By V_{IN}
 $V_{IN} = 48$ Vdc Load: $I_O = 0.4$ A
 Ch1: V_{IN} Ch2: V_O

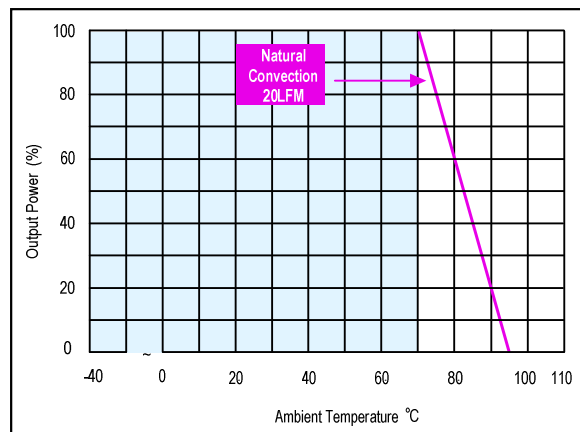

Figure 138: AYA00A48-L Derating Curve
 $V_{IN} = 48$ Vdc

AYA00AA48-L Performance Curves

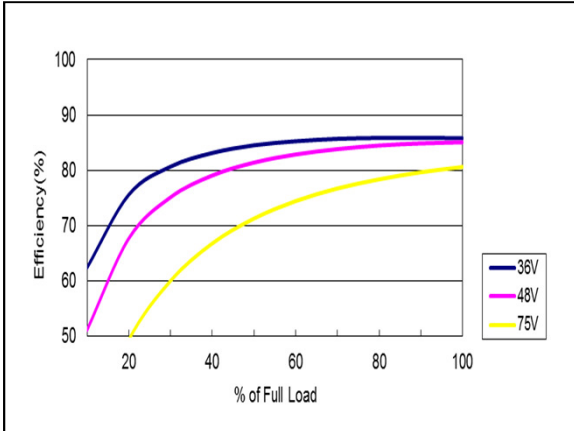

Figure 139: AYA00AA48-L Efficiency Versus Output Current Curve
 $V_{IN} = 36$ to $75Vdc$ Load: $I_o = 0$ to $0.2A$

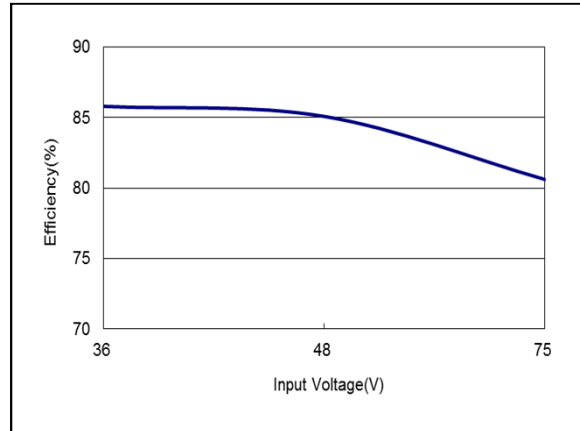

Figure 140: AYA00AA48-L Efficiency Versus Input Voltage Curve
 $V_{IN} = 36$ to $75Vdc$ Load: $I_o = 0.2A$

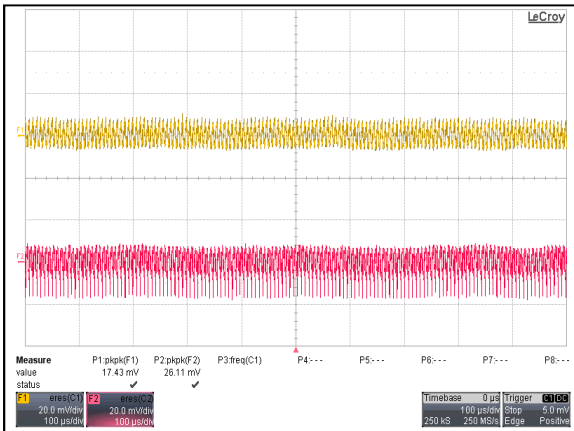

Figure 141: AYA00AA48-L Ripple and Noise Measurement
 $V_{IN} = 48Vdc$ Load: $I_o = 0.2A$
 Ch 1: V_{O1} Ch 2: V_{O2}

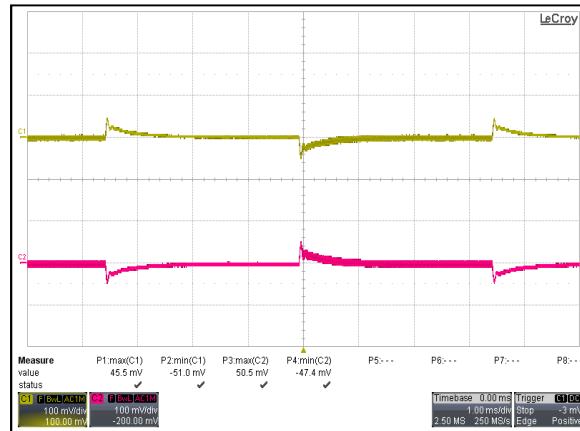

Figure 142: AYA00AA48-L Transient Response
 $V_{IN} = 48Vdc$ Load: $I_o = 100\%$ to 75% Load Change
 Ch 1: V_{O1} Ch 2: V_{O2}

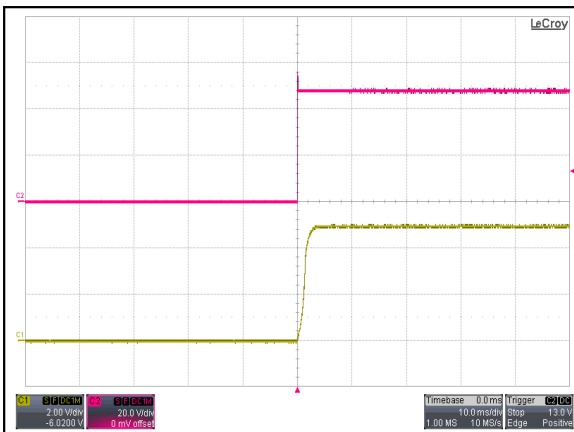

Figure 143: AYA00AA48-L Output Voltage Startup Characteristic By V_{IN}
 $V_{IN} = 48Vdc$ Load: $I_o = 0.2A$
 Ch1: V_{IN} Ch2: V_O

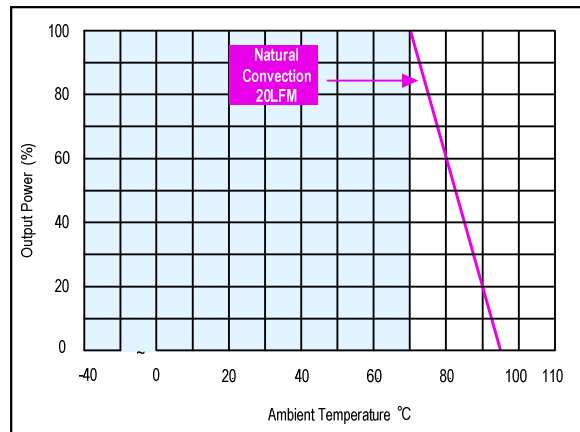

Figure 144: AYA00AA48-L Derating Curve
 $V_{IN} = 48Vdc$

AYA00B48-L Performance Curves

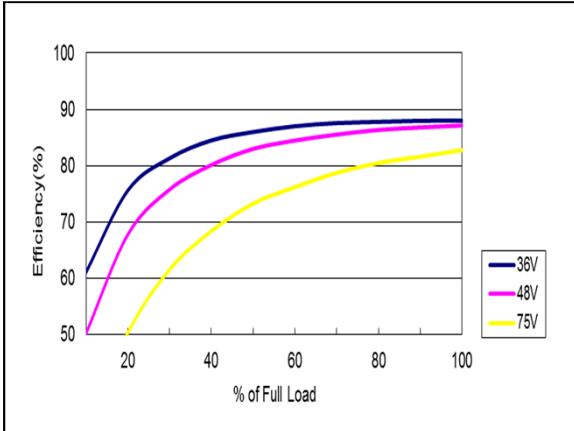

Figure 145: AYA00B48-L Efficiency Versus Output Current Curve
 $V_{IN} = 36$ to $75Vdc$ Load: $I_o = 0$ to $0.167A$

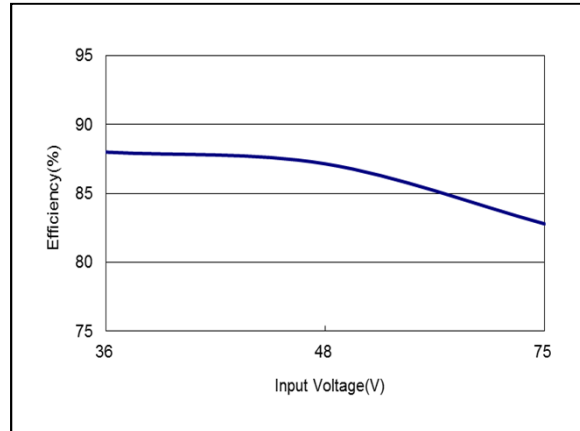

Figure 146: AYA00B48-L Efficiency Versus Input Voltage Curve
 $V_{IN} = 36$ to $75Vdc$ Load: $I_o = 0.167A$

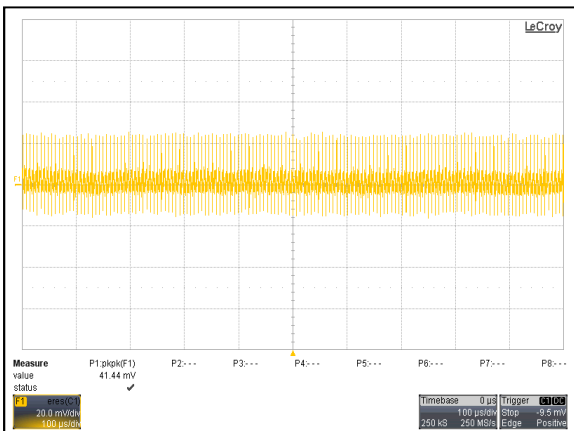

Figure 147: AYA00B48-L Ripple and Noise Measurement
 $V_{IN} = 48Vdc$ Load: $I_o = 0.167A$
 Ch 1: V_o

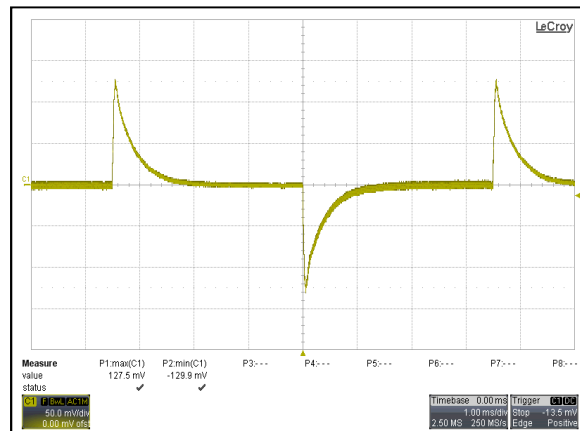

Figure 148: AYA00B48-L Transient Response
 $V_{IN} = 48Vdc$ Load: $I_o = 100\%$ to 75% Load Change
 Ch 1: V_o

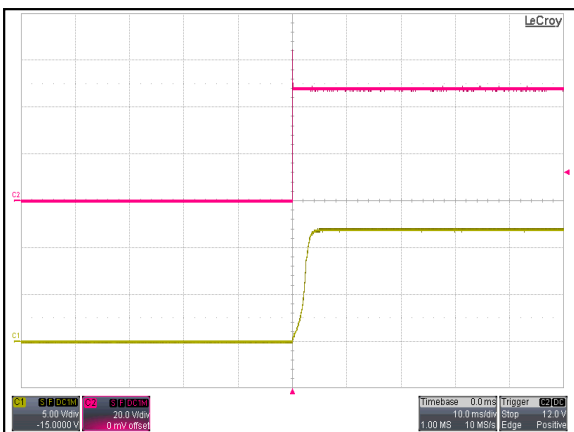

Figure 149: AYA00B48-L Output Voltage Startup Characteristic By V_{IN}
 $V_{IN} = 48Vdc$ Load: $I_o = 0.167A$
 Ch1: V_{IN} Ch2: V_o

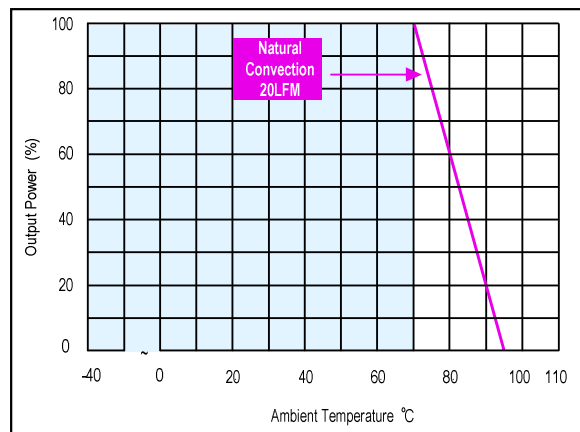

Figure 150: AYA00B48-L Derating Curve
 $V_{IN} = 48Vdc$

AYA00BB48-L Performance Curves

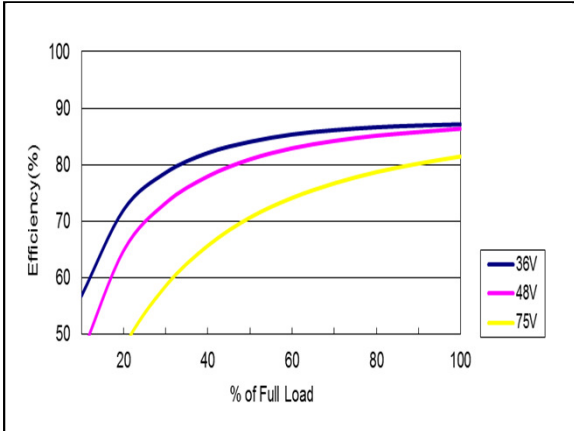

Figure 151: AYA00BB48-L Efficiency Versus Output Current Curve
 $V_{IN} = 36$ to $75Vdc$ Load: $I_o = 0$ to $0.083A$

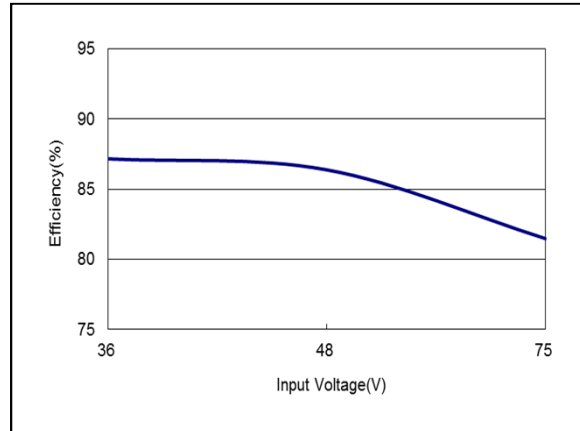

Figure 152: AYA00BB48-L Efficiency Versus Input Voltage Curve
 $V_{IN} = 36$ to $75Vdc$ Load: $I_o = 0.083A$

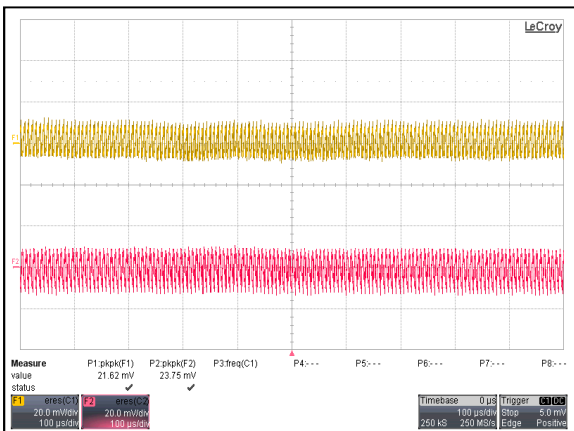

Figure 153: AYA00BB48-L Ripple and Noise Measurement
 $V_{IN} = 48Vdc$ Load: $I_o = 0.083A$
 Ch 1: V_{O1} Ch 2: V_{O2}

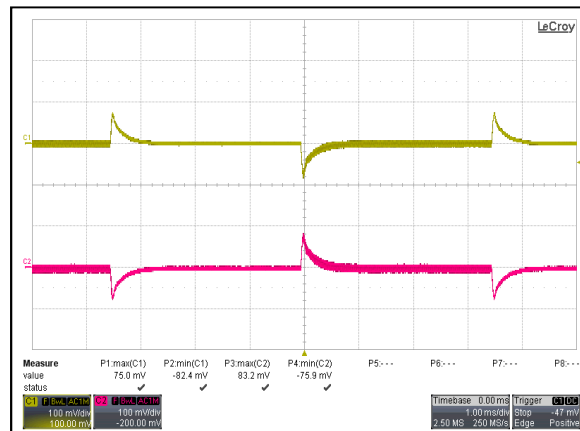

Figure 154: AYA00BB48-L Transient Response
 $V_{IN} = 48Vdc$ Load: $I_o = 100\%$ to 75% Load Change
 Ch 1: V_{O1} Ch 2: V_{O2}

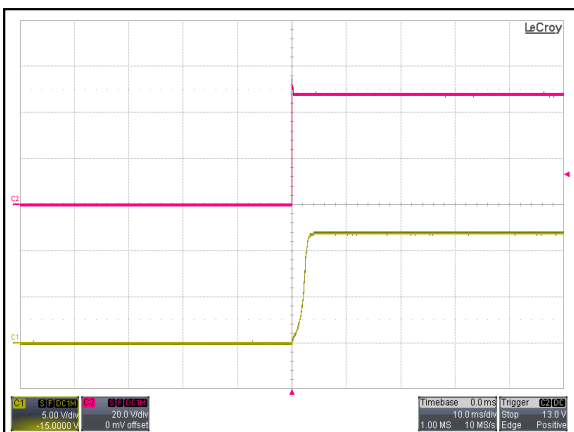

Figure 155: AYA00BB48-L Output Voltage Startup Characteristic By V_{IN}
 $V_{IN} = 48Vdc$ Load: $I_o = 0.083A$
 Ch1: V_{IN} Ch2: V_O

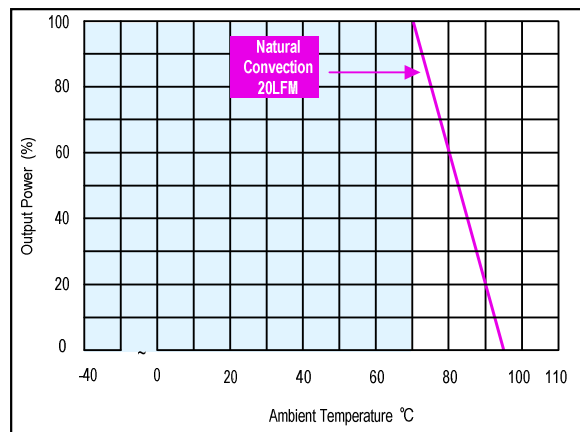

Figure 156: AYA00BB48-L Derating Curve
 $V_{IN} = 48Vdc$

AYA00C48-L Performance Curves

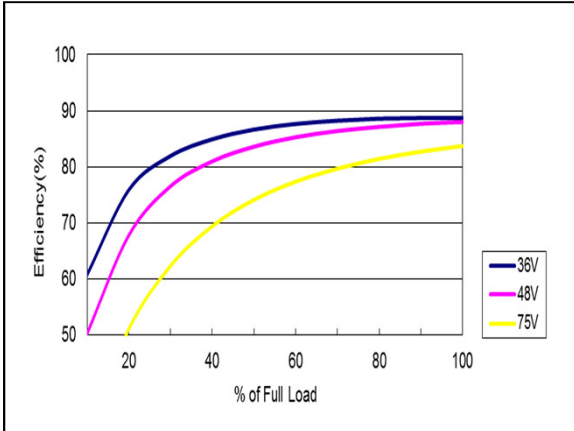

Figure 157: AYA00C48-L Efficiency Versus Output Current Curve
 $V_{IN} = 36$ to $75Vdc$ Load: $I_O = 0$ to $0.134A$

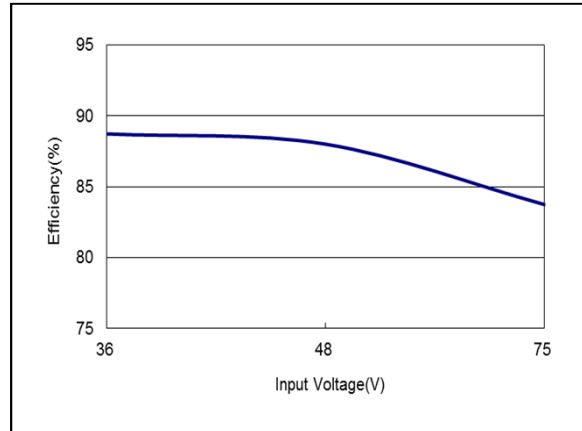

Figure 158: AYA00C48-L Efficiency Versus Input Voltage Curve
 $V_{IN} = 36$ to $75Vdc$ Load: $I_O = 0.134A$

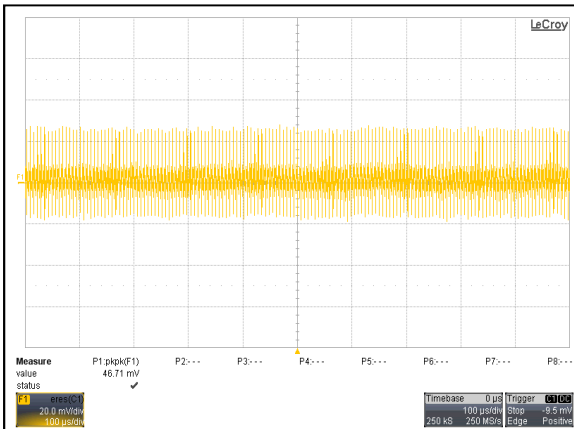

Figure 159: AYA00C48-L Ripple and Noise Measurement
 $V_{IN} = 48Vdc$ Load: $I_O = 0.134A$
 Ch 1: V_O

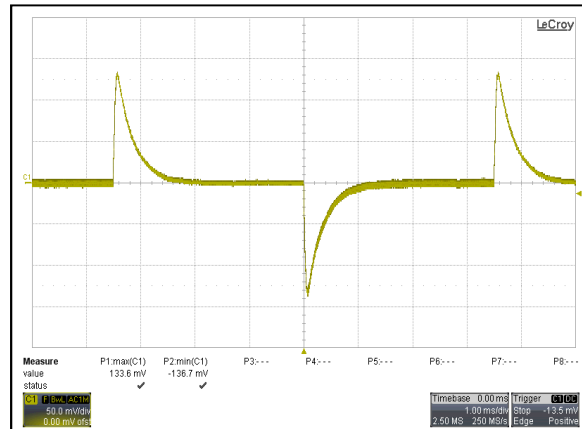

Figure 160: AYA00C48-L Transient Response
 $V_{IN} = 48Vdc$ Load: $I_O = 100\%$ to 75% Load Change
 Ch 1: V_O

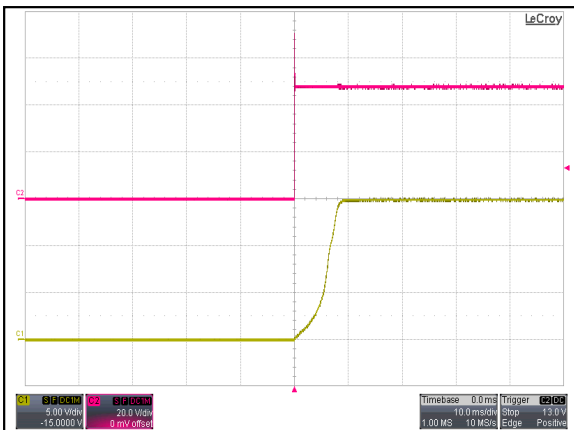

Figure 161: AYA00C48-L Output Voltage Startup Characteristic By V_{IN}
 $V_{IN} = 48Vdc$ Load: $I_O = 0.134A$
 Ch1: V_{IN} Ch2: V_O

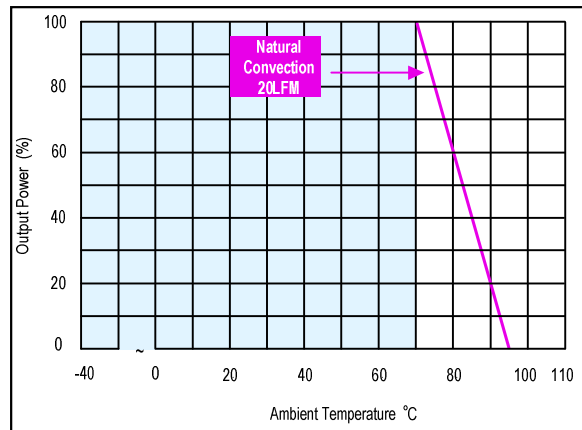

Figure 162: AYA00C48-L Derating Curve
 $V_{IN} = 48Vdc$

AYA00CC48-L Performance Curves

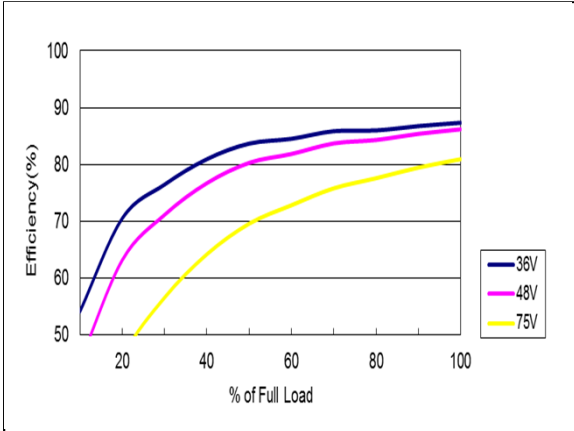

Figure 163: AYA00CC48-L Efficiency Versus Output Current Curve
 $V_{IN} = 36$ to $75Vdc$ Load: $I_o = 0$ to $0.067A$

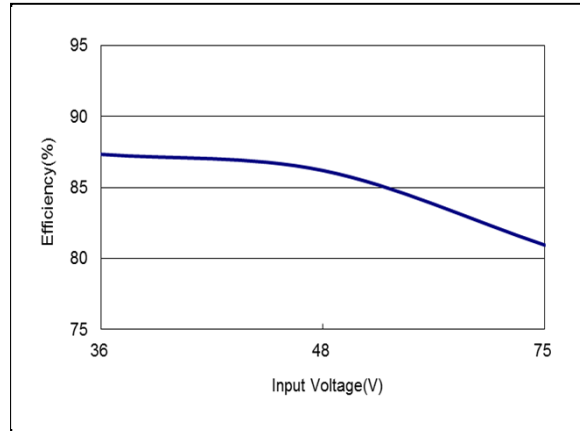

Figure 164: AYA00CC48-L Efficiency Versus Input Voltage Curve
 $V_{IN} = 36$ to $75Vdc$ Load: $I_o = 0.067A$

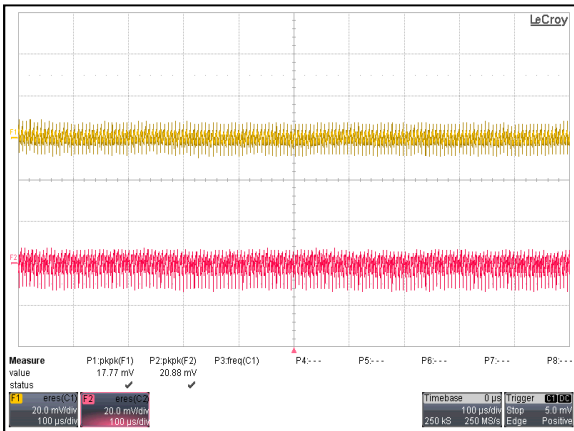

Figure 165: AYA00CC48-L Ripple and Noise Measurement
 $V_{IN} = 48Vdc$ Load: $I_o = 0.067A$
 Ch 1: V_{O1} Ch 2: V_{O2}

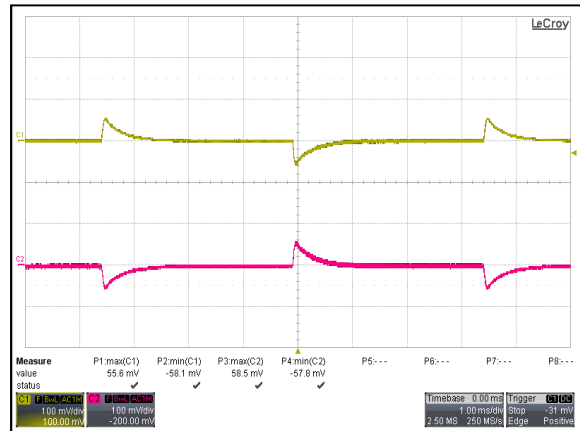

Figure 166: AYA00CC48-L Transient Response
 $V_{IN} = 48Vdc$ Load: $I_o = 100\%$ to 75% Load Change
 Ch 1: V_{O1} Ch 2: V_{O2}

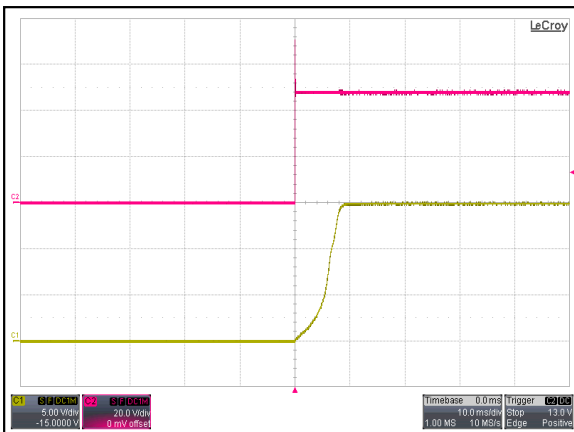

Figure 167: AYA00CC48-L Output Voltage Startup Characteristic By V_{IN}
 $V_{IN} = 48Vdc$ Load: $I_o = 0.067A$
 Ch1: V_{IN} Ch2: V_O

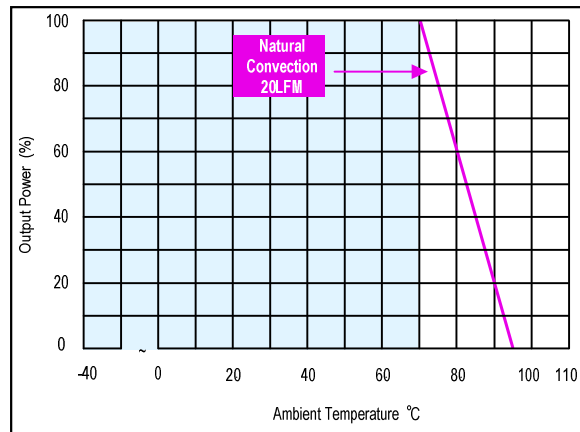
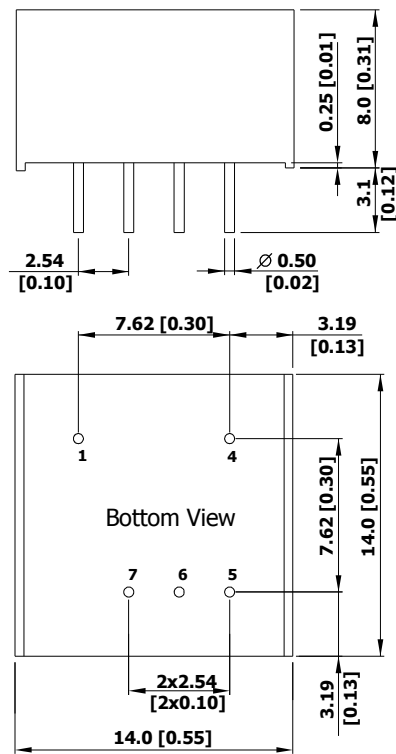

Figure 168: AYA00CC48-L Derating Curve
 $V_{IN} = 48Vdc$

Mechanical Specifications

Mechanical Outlines



Note:

- 1.All dimensions in mm (inches)
- 2.Tolerance: $X.X \pm 0.5$ ($X.XX \pm 0.02$)
 $X.XX \pm 0.25$ ($X.XXX \pm 0.01$)
- 3.Pin diameter 0.5 ± 0.05 (0.02 ± 0.002)

Physical Characteristics

Device code suffix	Characteristics
Case Size	14.0x14.0x8.0mm (0.55x0.55x0.31 inches)
Case Material	Non-Conductive Black Plastic (Flammability to UL 94V-0 rated)
Pin Material	Tinned Copper
Weight	3.9g

Pin Connections

Single output

- Pin 1 – -Vin
- Pin 4 – +Vin
- Pin 5 – +Vout
- Pin 6 – No Pin
- Pin 7 – -Vout

Dual Output

- Pin 1 – -Vin
- Pin 4 – +Vin
- Pin 5 – +Vout
- Pin 6 – Common
- Pin 7 – -Vout

Environmental Specifications

EMC Immunity

AYA 2W series power supply is designed to meet the following EMC immunity specifications.

Table 4. EMC Specifications

Parameter	Standards & Level	Performance
EMI	EN55022, FCC part 15	Class A & Class B ¹
ESD	EN61000-4-2 Air $\pm 8KV$, Contact $\pm 6KV$	A
Radiated Immunity	EN61000-4-3 10V/M	A
Fast transient	EN61000-4-4 $\pm 2KV$	A
Surge	EN61000-4-5 $\pm 1KV$	A
Conducted Immunity	EN61000-4-6 10Vrms	A
EN55024		

Note1: To meet EN55022 Class A, B an external filter, please contact Artesyn.

EMC Considerations

External filter meets Conducted & Radiated EMI & EN 55022, class A; FCC part 15, level A

Conducted and radiated emissions EN55022 Class B

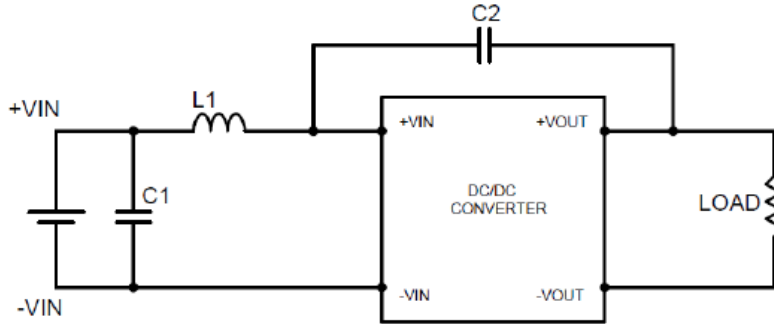

Table 5. Class A & Class B specifications

Class	Model	C1	L1
Class A	AYA00XX05-L	10uF/16V 1206 X7R MLCC	744774033
	AYA00XX12-L	4.7uF/25V 1206 X7R MLCC	744774118
	AYA00XX24-L	4.7uF/50V 1206 X7R MLCC	744774139
	AYA00XX48-L	2.2uF/100V 1206 X7R MLCC	744744168
Class B	AYA00XX05-L	10uF/16V 1206 X7R MLCC	744744068
	AYA00XX12-L	10uF/25V 1206 X7R MLCC	744744127
	AYA00XX24-L	10uF/50V 1206 X7R MLCC	744744139
	AYA00XX48-L	3.3uF/100V 1206 X7S MLCC	744744168

Safety Certifications

The AYA 2W power supply is intended for inclusion in other equipment and the installer must ensure that it is in compliance with all the requirements of the end application. This product is only for inclusion by professional installers within other equipment and must not be operated as a stand alone product.

Table 6. Safety Certifications for AYA series power supply system

Document	Description
cUL/UL 60950-1 (UL certificate)	US and Canada Requirements
IEC/EN 60950-1 (CB-scheme)	European Requirements
CE Marking	European Conformity

MTBF and Reliability

The MTBF of AYA 2W series of DC/DC converters has been calculated using MIL-HDBK 217F NOTICE2, Operating Temperature 25 °C, Ground Benign.

Model	MTBF	Unit
AYA00F05-L	4,261,825	Hours
AYA00F12-L	4,570,451	
AYA00F24-L	4,347,969	
AYA00F48-L	4,473,197	
AYA00A05-L	3,988,844	
AYA00A12-L	4,029,105	
AYA00A24-L	3,870,680	
AYA00A48-L	4,226,376	
AYA00AA05-L	3,969,049	
AYA00AA12-L	4,274,322	
AYA00AA24-L	4,216,872	
AYA00AA48-L	3,877,633	
AYA00B05-L	5,184,269	
AYA00B12-L	5,187,740	
AYA00B24-L	4,857,279	
AYA00B48-L	5,152,740	
AYA00BB05-L	4,527,103	
AYA00BB12-L	4,706,233	
AYA00BB24-L	4,487,989	
AYA00BB48-L	4,415,511	
AYA00C05-L	5,499,102	
AYA00C12-L	5,464,091	
AYA00C24-L	4,959,378	
AYA00C48-L	5,324,187	
AYA00CC05-L	4,937,872	
AYA00CC12-L	4,828,841	
AYA00CC24-L	4,584,419	
AYA00CC48-L	5,324,187	

Application Notes

Input Source Impedance

The power module should be connected to a low ac-impedance input source. Highly inductive source impedances can affect the stability of the power module. In applications where power is supplied over long lines and output loading is high, it may be necessary to use a capacitor at the input to ensure startup.

Capacitor mounted close to the power module helps ensure stability of the unit, it is commended to use a good quality low Equivalent Series Resistance ($ESR < 1.0\Omega$ at 100 KHz) capacitor of a $8.2\mu F$ for the 5V input device, a $3.3\mu F$ for the 12V input devices and a $1.5\mu F$ for the 24V and 48V devices.

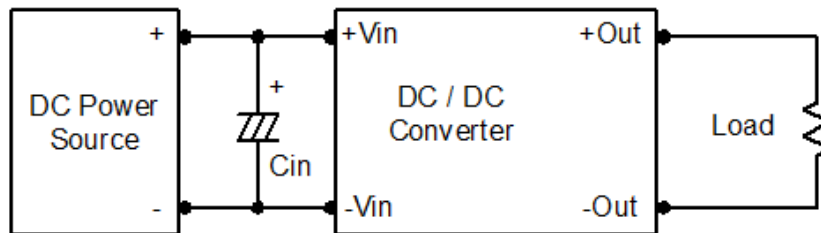

Output Ripple Reduction

A good quality low ESR capacitor placed as close as practicable across the load will give the best ripple and noise performance. To reduce output ripple, it is recommended to use 3.3 μ F capacitors at the output.

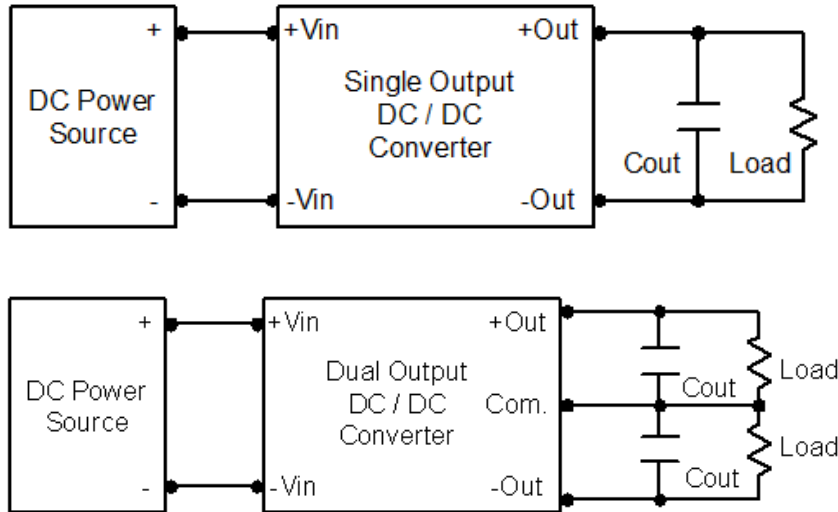

Peak-to-Peak Output Noise Measurement Test

Use a Cout 0.47 μ F ceramic capacitor. Scope measurement should be made by using a BNC socket, measurement bandwidth is 0-20 MHz. Position the load between 50 mm and 75 mm from the DC/DC Converter.

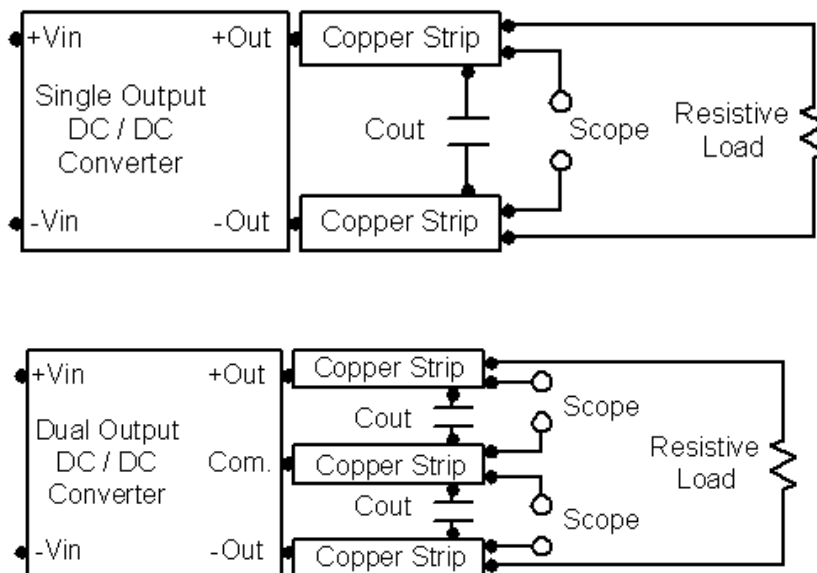

Over Current Protection

To provide protection in a fault (output overload) condition, the unit is equipped with internal current limiting circuitry and can endure current limiting for an unlimited duration. At the point of current-limit inception, the unit shifts from voltage control to current control. The unit operates normally once the output current is brought back into its specified range.

Thermal Considerations

Many conditions affect the thermal performance of the power module, such as orientation, airflow over the module and board spacing. To avoid exceeding the maximum temperature rating of the components inside the power module, the case temperature must be kept below 105°C. The derating curves are determined from measurements obtained in a test setup.

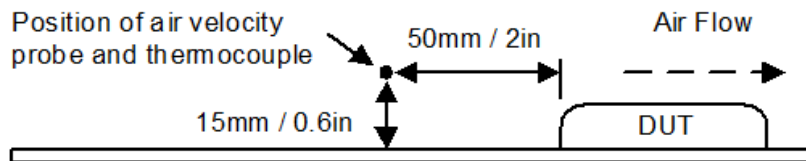

Maximum Capacitive Load

The AYA 2W series converters have a limitation of maximum connected capacitance at the output. The power module may be operated in current limiting mode during start-up, affecting the ramp-up and the startup time. The maximum capacitance can be found in the data sheet.

Packaging Information

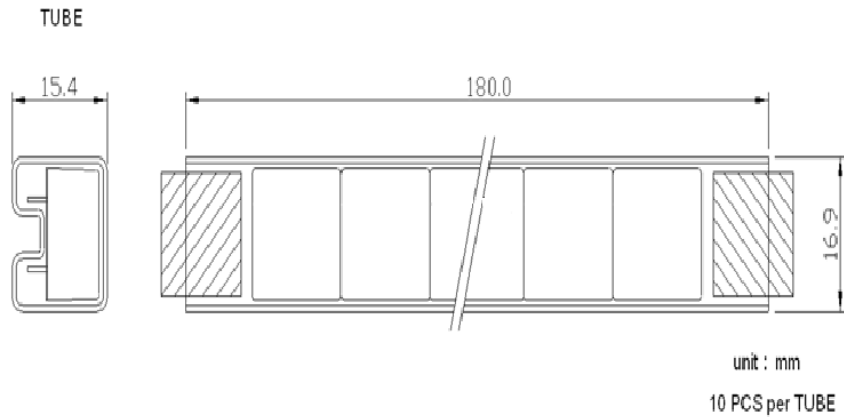

Soldering and Reflow Considerations

Lead free wave solder profile for AYA 2W Series

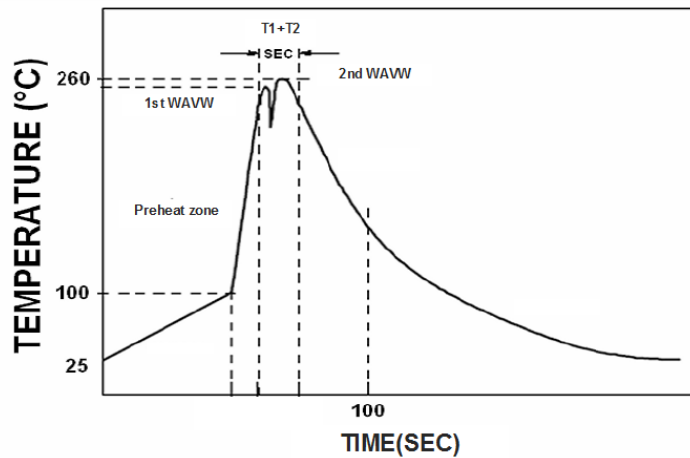

Zone	Reference Parameter
Preheat zone	Rise temp. speed : 3°C/sec max.
	Preheat temp. : 100~130°C
Actual heating	Peak temp. : 250~260°C
	Peak time(T1+T2): 4~6 sec

Reference Solder: Sn-Ag-Cu: Sn-Cu: Sn-Ag
 Hand Welding: Soldering iron: Power 60W
 Welding Time: 2~4 sec
 Temp.: 380~400 °C

Record of Revision and Changes

Issue	Date	Description	Originators
1.0	08.28.2017	First Issue	Kelly. M

WORLDWIDE OFFICES

Americas

2900 S.Diablo Way
Tempe, AZ 85282
USA
+1 888 412 7832

Europe (UK)

Waterfront Business Park
Merry Hill, Dudley
West Midlands, DY5 1LX
United Kingdom
+44 (0) 1384 842 211

Asia (HK)

14/F, Lu Plaza
2 Wing Yip Street
Kwun Tong, Kowloon
Hong Kong
+852 2176 3333



www.artesyn.com

While every precaution has been taken to ensure accuracy and completeness in this literature, Artesyn Embedded Technologies assumes no responsibility, and disclaims all liability for damages resulting from use of this information or for any errors or omissions. Artesyn Embedded Technologies, Artesyn and the Artesyn Embedded Technologies logo are trademarks and service marks of Artesyn Technologies, Inc. All other names and logos referred to are trade names, trademarks, or registered trademarks of their respective owners.
© 2014 All rights reserved.

For more information: www.artesyn.com/power
For support: productsupport.ep@artesyn.com