

**General Description**

The MAX2612–MAX2616 is a family of high-performance broadband gain blocks designed for use as a PA predriver, low-noise amplifier, or as a cascadable 50Ω amplifier with up to +19.5dBm output power. These devices are suited for many applications that include cellular infrastructure, private or commercial microwave radios, and CATV or cable modems. The operating frequency range extends from 40MHz to 4000MHz. The amplifier operates on a +3V to a +5.25V supply with input and output ports internally matched to 50Ω. The device family is available in a pin-to-pin compatible, compact 2mm x 3mm TDFN lead-free package.

**Applications**

- Cellular Infrastructure
- Microwave Radio
- Wireless LAN
- Test and Measurement

*Ordering Information appears at end of data sheet.*

**Features**

- Extremely Flat Frequency Response
  - < 0.5dB, 1GHz to 4GHz
- Low Noise Figure: 2.0dB at  $f_{RFIN} = 2.0GHz$
- 40MHz to 4000MHz Frequency Range
- Industry’s Highest Max  $P_{IN}$  Rating
- Large OIP3 Ranges
  - MAX2615/MAX2616: +37dBm
  - MAX2612: +35.2dBm
  - MAX2613: +31.2dBm
  - MAX2614: +30dBm
- Output P1dB: +19.5dBm (MAX2615/MAX2616)
- High Gain: 18.6dB
- Shutdown Mode (MAX2612/MAX2613/MAX2614/MAX2616)
- Adjustable Bias Current for Improved OIP3 (MAX2615)
- 3.0V to 5.25V Supply Range
- Compact 2mm x 3mm TDFN Package
- Industry-High ESD Rating: 2.5kV HBM

**Typical Application Circuits**

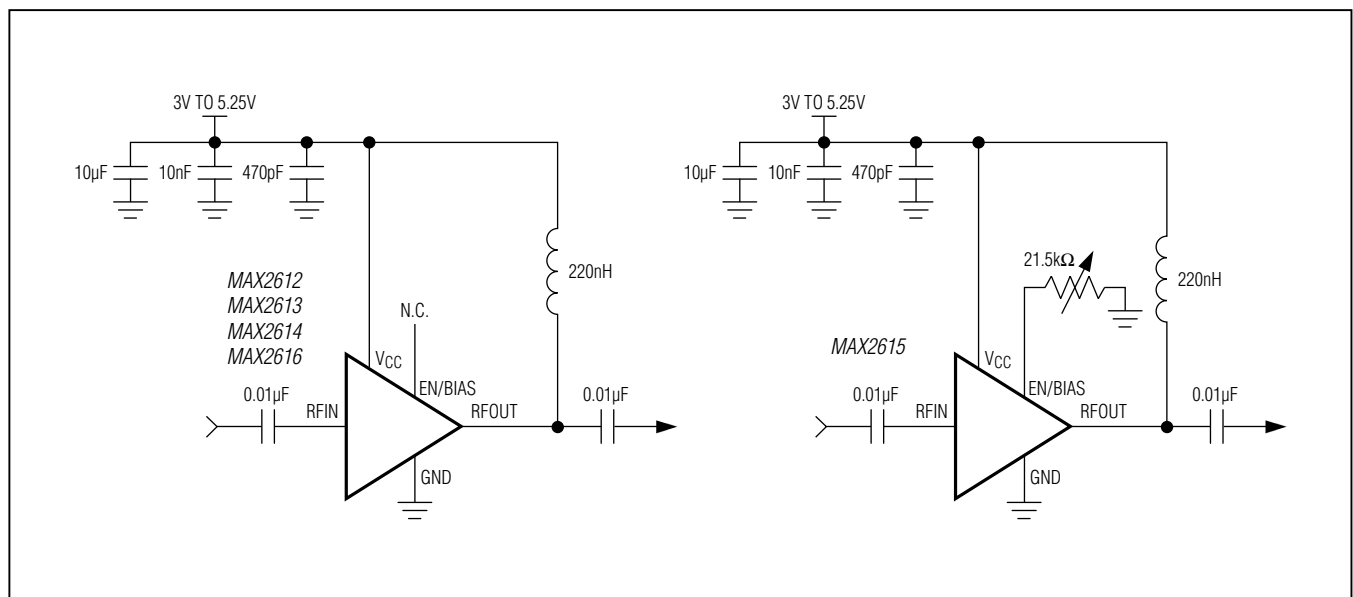

### Absolute Maximum Ratings

V <sub>CC</sub> , EN/RBIAS, RFOUT to GND	-0.3V to +6.0V	Junction Temperature	+150°C
Maximum Input Power (RFIN)	+20dBm	Storage Temperature Range	-65°C to +160°C
Continuous Power Dissipation (T <sub>A</sub> = +70°C)		Lead Temperature (soldering, 10s)	+300°C
TDFN (derates 16.7mW/°C above +70°C)	1333.3mW	Soldering Temperature (reflow)	+260°C
Operating Temperature Range	-40°C to +85°C		

Stresses beyond those listed under “Absolute Maximum Ratings” may cause permanent damage to the device. These are stress ratings only, and functional operation of the device at these or any other conditions beyond those indicated in the operational sections of the specifications is not implied. Exposure to absolute maximum rating conditions for extended periods may affect device reliability.

### Package Thermal Characteristics (Note 1)

TDFN

Junction-to-Ambient Thermal Resistance (θ <sub>JA</sub> )	60°C/W	Junction-to-Case Thermal Resistance (θ <sub>JC</sub> )	11°C/W
---	--------	--	--------

**Note 1:** Package thermal resistances were obtained using the method described in JEDEC specification JESD51-7, using a four-layer board. For detailed information on package thermal considerations, refer to [www.maximintegrated.com/thermal-tutorial](http://www.maximintegrated.com/thermal-tutorial).

### DC Electrical Characteristics

(MAX2612/MAX2613/MAX2614/MAX2615/MAX2616 EV Kit, V<sub>CC</sub> = +5.0V, no RF input signals at RFIN, T<sub>A</sub> = -40°C to +85°C, unless otherwise noted. Typical values are at V<sub>RFOUT</sub> = +5V, T<sub>A</sub> = +25°C, unless otherwise noted.) (Note 2)

PARAMETER	CONDITIONS	MIN	TYP	MAX	UNITS
Supply Voltage	DC voltage at RFOUT	3	5	5.25	V
Supply Current	MAX2612		69		mA
	MAX2613		51.2		
	MAX2614		40.6		
	MAX2615, R <sub>BIAS</sub> = 21.5kΩ		81.5		
	MAX2616		80.6		
Shutdown Supply Current	EN logic-low		7		µA
RBIAS Minimum	MAX2615		10		kΩ

### AC Electrical Characteristics

(MAX2612/MAX2613/MAX2614/MAX2615/MAX2616 EV Kit, V<sub>CC</sub> = +5V, T<sub>A</sub> = -40°C to +85°C, unless otherwise noted. Typical values are at V<sub>RFOUT</sub> = +5V, T<sub>A</sub> = +25°C, unless otherwise noted.) (Note 2)

PARAMETER	CONDITIONS		MIN	TYP	MAX	UNITS
RFIN Frequency Range			40		4000	MHz
Power Gain	f <sub>RFIN</sub> = 1000MHz (Note 3)	MAX2612		18.3		dB
		MAX2613		18.6		
		MAX2614		18.6		
		MAX2615		18.5		
		MAX2616		18.4		
	f <sub>RFIN</sub> = 4000MHz (Note 3)	MAX2612		17.5		
		MAX2613		18.1		
		MAX2614		17.5		
		MAX2615		18.0		
		MAX2616		18.0		

**AC Electrical Characteristic (continued)**

(MAX2612/MAX2613/MAX2614/MAX2615/MAX2616 EV Kit,  $V_{CC} = +5V$ ,  $T_A = -40^{\circ}C$  to  $+85^{\circ}C$ , unless otherwise noted. Typical values are at  $V_{RFOUT} = +5V$ ,  $T_A = +25^{\circ}C$ , unless otherwise noted.) (Note 2)

PARAMETER	CONDITIONS		MIN	TYP	MAX	UNITS
Gain Flatness Across Band	$f_{RFIN} = 1000MHz < f_{RFOUT} < 3000MHz$ (Note 3)	MAX2612		0.2		dB
		MAX2613		0.1		
		MAX2614		0.15		
		MAX2615		0.15		
		MAX2616		0.1		
	$f_{RFIN} = 1000MHz < f_{RFOUT} < 4000MHz$ (Note 3)	MAX2612		0.8		
		MAX2613		0.5		
		MAX2614		1.1		
		MAX2615		0.5		
		MAX2616		0.4		
Noise Figure	$f_{RFIN} = 2000MHz$ (Note 3)	MAX2612		2.1	2.65	dB
		MAX2613		2	2.42	
		MAX2614		2	2.35	
		MAX2615		2.2	2.95	
		MAX2616		2.2	2.85	
OIP3	Input tones at 1000MHz and 1001MHz at -15dBm/tone	MAX2612		35.2		dBm
		MAX2613		31.2		
		MAX2614		29.7		
		MAX2615		37.6		
		MAX2616		37.2		
Output P1dB	$f_{RFIN} = 1000MHz$ (Note 3)	MAX2612		18.2		dBm
		MAX2613		15.5		
		MAX2614		13.6		
		MAX2615		19.5		
		MAX2616		19.5		
Reverse Isolation	$40MHz < f_{RFOUT} < 4000MHz$			20		dB
RFIN Input Return Loss	$40MHz < f_{RFOUT} < 1000MHz$	MAX2612		15		dB
		MAX2613		15		
		MAX2614		12		
		MAX2615		15		
		MAX2616		15		
	$1000MHz < f_{RFOUT} < 4000MHz$	MAX2612		12		
		MAX2613		8		
		MAX2614		8		
		MAX2615		12		
		MAX2616		12		

**AC Electrical Characteristic (continued)**

(MAX2612/MAX2613/MAX2614/MAX2615/MAX2616 EV Kit,  $V_{CC} = +5V$ ,  $T_A = -40^{\circ}C$  to  $+85^{\circ}C$ , unless otherwise noted. Typical values are at  $V_{RFOUT} = +5V$ ,  $T_A = +25^{\circ}C$ , unless otherwise noted.) (Note 2)

PARAMETER	CONDITIONS	MIN	TYP	MAX	UNITS
RFOUT Output Return Loss	40MHz < $f_{RFOUT}$ < 1000MHz	MAX2612		20	dB
		MAX2613		15	
		MAX2614		12	
		MAX2615		20	
		MAX2616		20	
	1000MHz < $f_{RFOUT}$ < 4000MHz	MAX2612		12	
		MAX2613		10	
		MAX2614		10	
		MAX2615		12	
		MAX2616		12	

**Note 2:** Min and max values are production tested at  $T_A = +25^{\circ}C$ . Min and max limits at  $T_A = +85^{\circ}C$  and  $T_A = -40^{\circ}C$  are guaranteed by design and characterization.

**Note 3:** Min and max values are guaranteed by design and characterization at  $T_A = +25^{\circ}C$ .

**Typical Operating Characteristics**

(MAX2612/MAX2613/MAX2614/MAX2615/MAX2616 EV Kit,  $V_{RFOUT} = +5V$ ,  $T_A = +25^{\circ}C$ .)

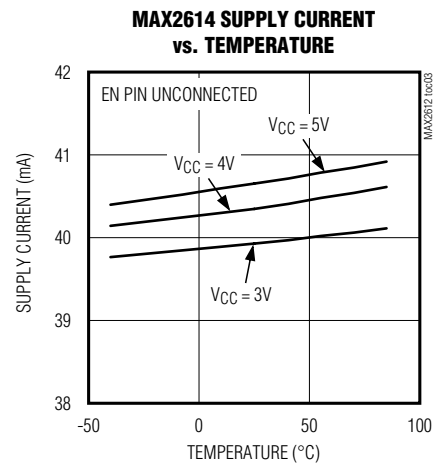
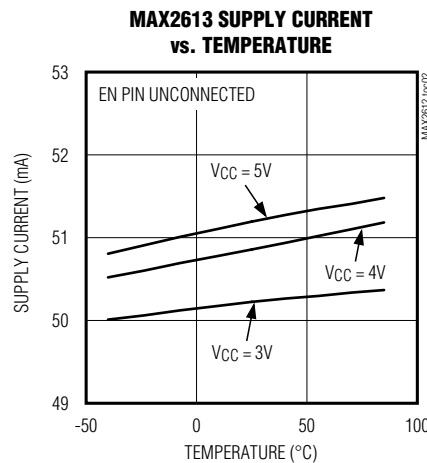
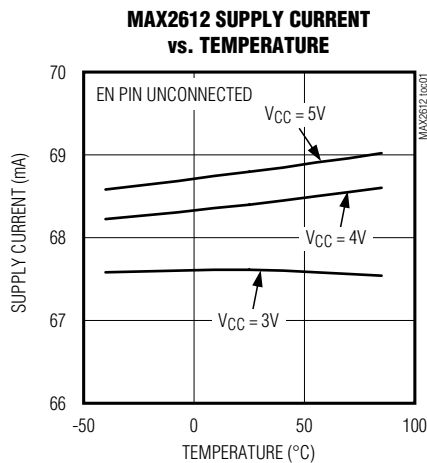

Typical Operating Characteristics (continued)

(MAX2612/MAX2613/MAX2614/MAX2615/MAX2616 EV Kit,  $V_{RFOUT} = +5V$ ,  $T_A = +25^{\circ}C$ .)

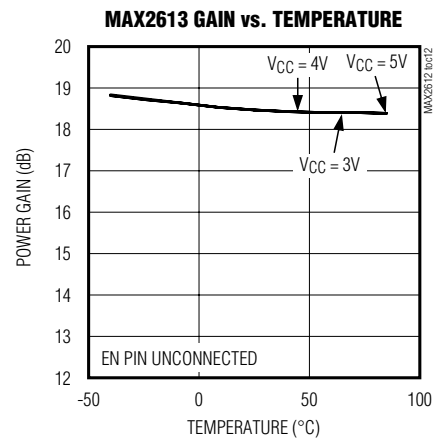
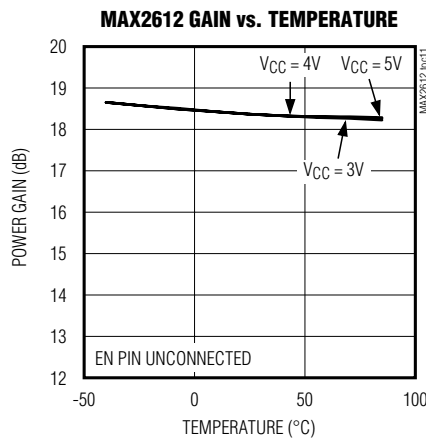
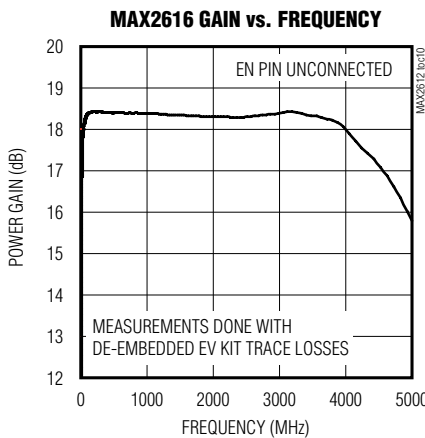
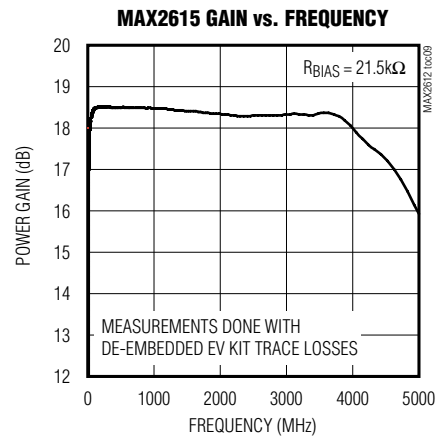
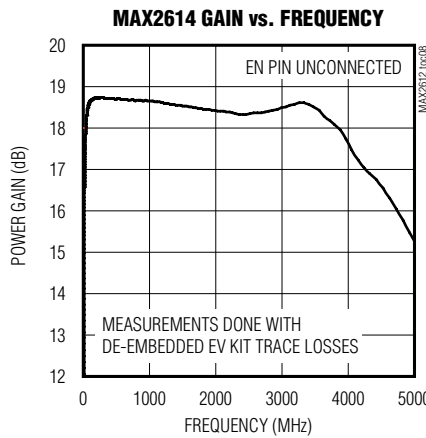
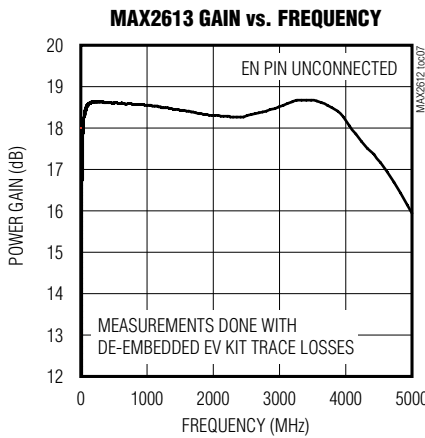
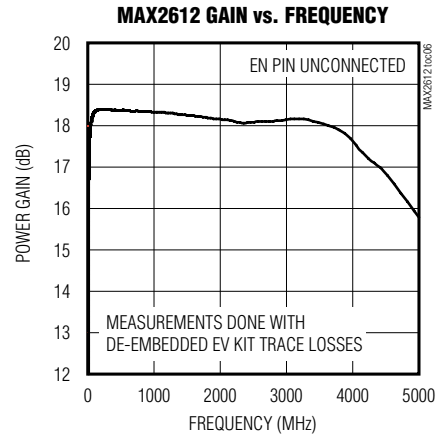
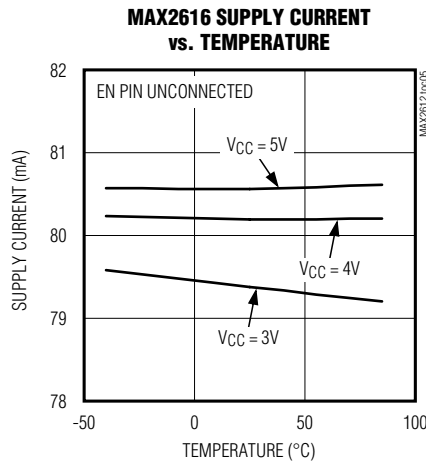
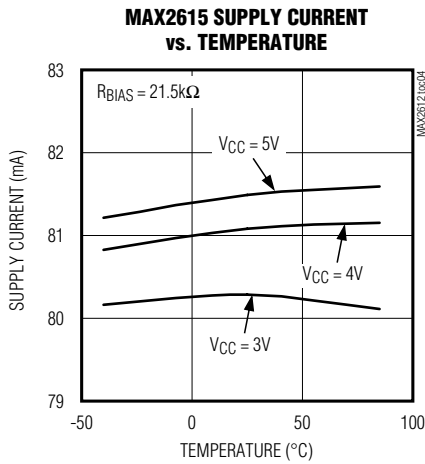

Typical Operating Characteristics (continued)

(MAX2612/MAX2613/MAX2614/MAX2615/MAX2616 EV Kit,  $V_{RFOUT} = +5V$ ,  $T_A = +25^\circ C$ .)

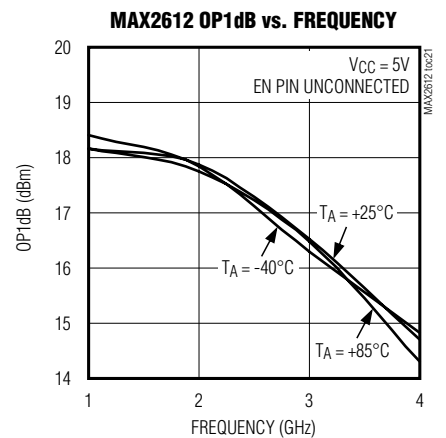
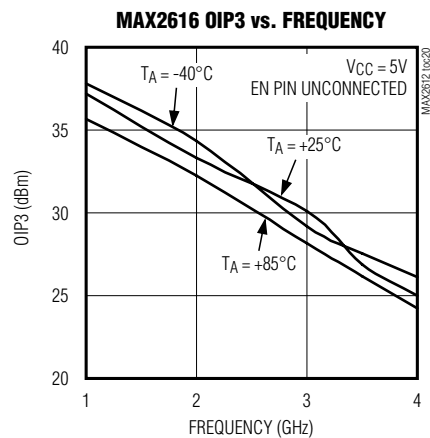
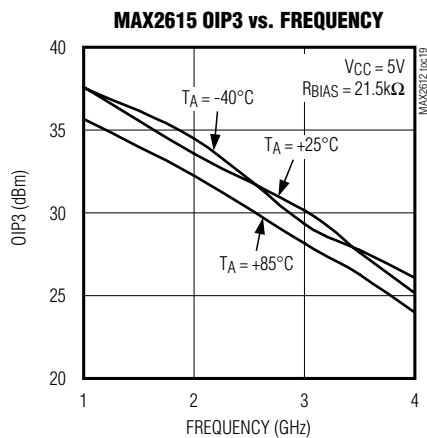
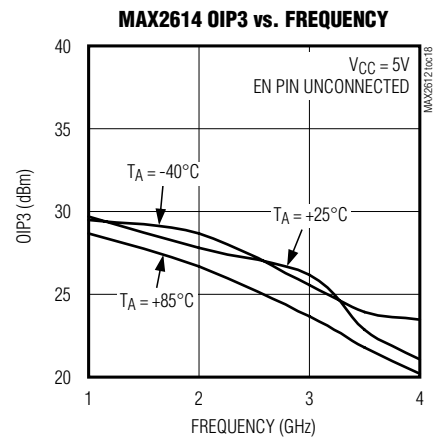
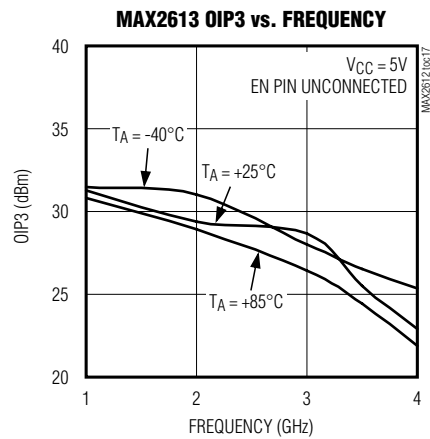
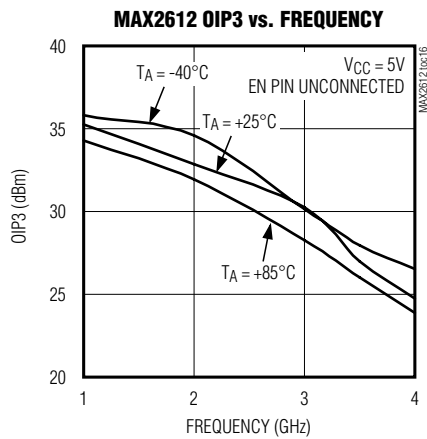
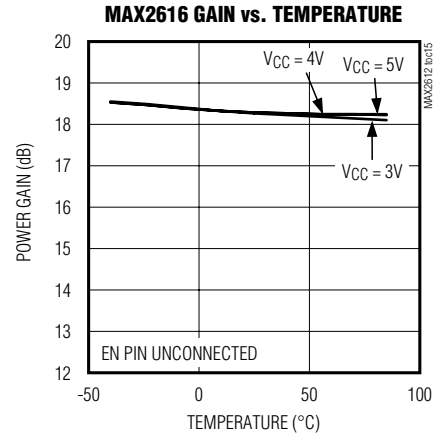
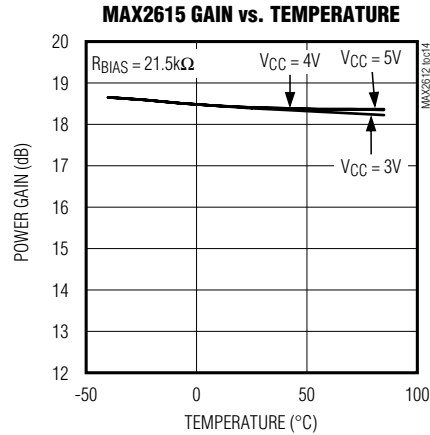
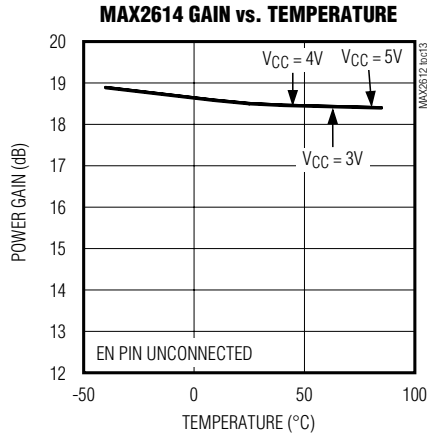

Typical Operating Characteristics (continued)

(MAX2612/MAX2613/MAX2614/MAX2615/MAX2616 EV Kit,  $V_{RFOUT} = +5V$ ,  $T_A = +25^{\circ}C$ .)

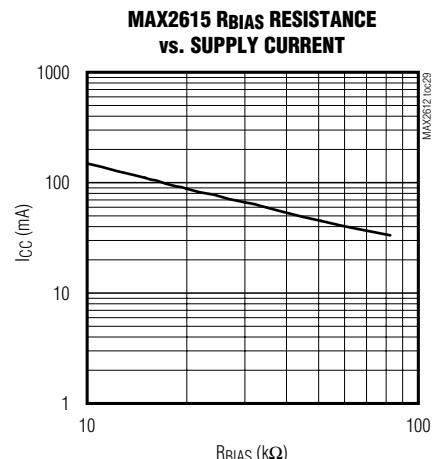
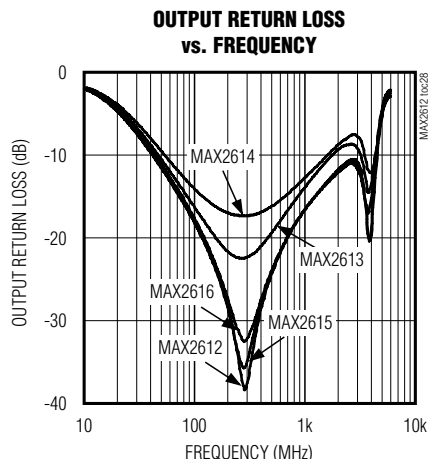
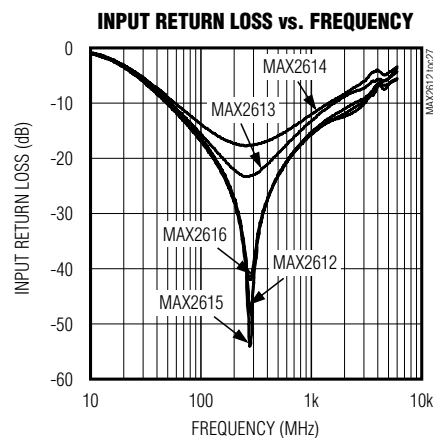
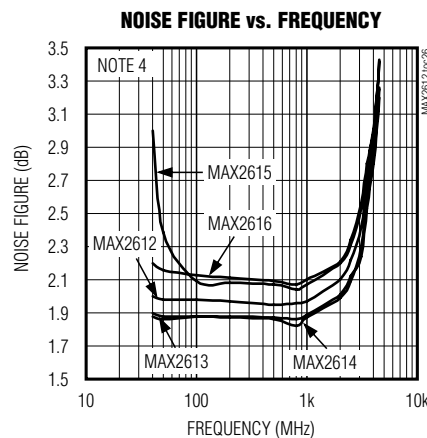
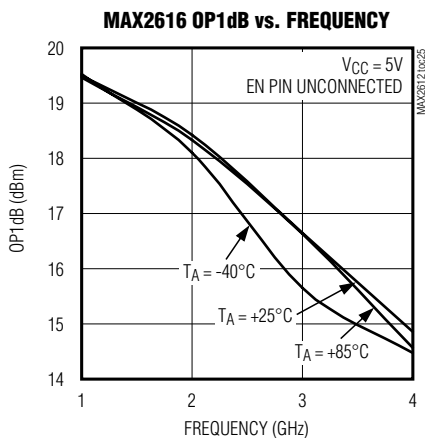
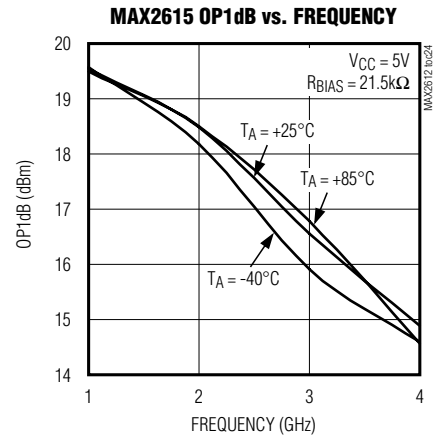
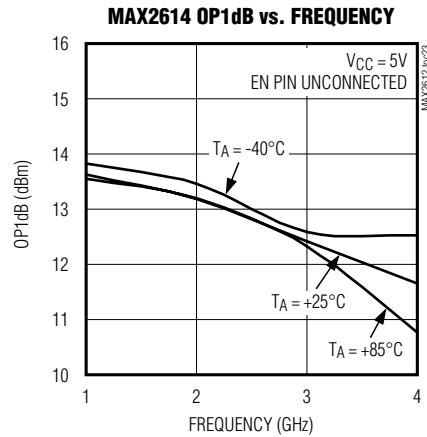
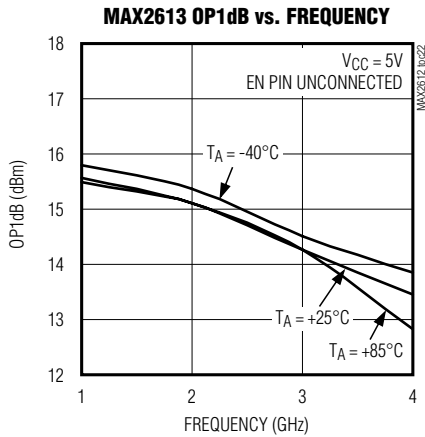

Pin Configuration

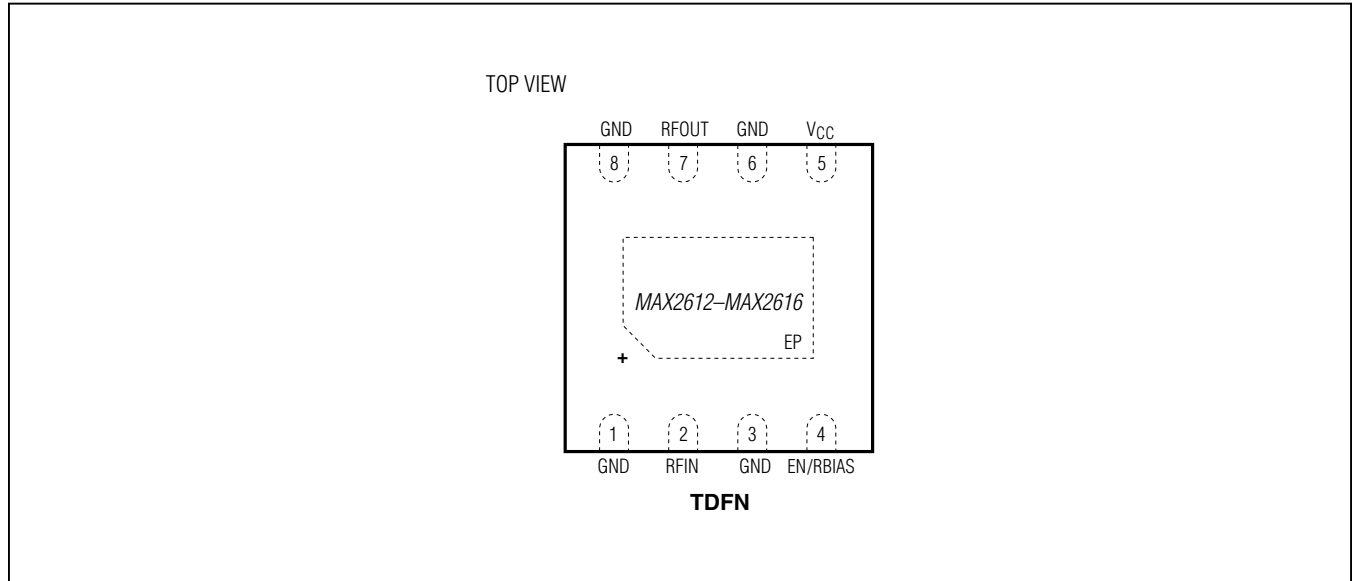

Pin Description

PIN	NAME	FUNCTION
1, 3, 6, 8	GND	Ground. Connect to PCB ground plane.
2	RFIN	RF Input. Connect to an RF source through a 0.01μF DC-blocking capacitor. Internally matched to 50Ω.
4	EN/RBIAS	Enable (MAX2612/MAX2613/MAX2614/MAX2616). Leave unconnected for normal operation or logic-low for disable mode operation. For applications that use the disable mode, it is recommended that the logic-high signal be derived from a high-impedance source such as an unterminated open-collector output or three-state (high-Z) output. Logic-low should be a low-impedance source or a switch to ground capable of sinking 10μA. RBIAS (MAX2615). Connect to a 21.5kΩ bias resistor to ground. The value can be adjusted to trade off supply current for OIP3. See the <i>Applications Information</i> section for further detail.
5	VCC	DC Supply Input. Place 470pF and 10nF decoupling capacitors as close to pin as possible. Also place a 10μF bulk capacitor on VCC; this must be a tantalum capacitor with ESR > 2Ω and can be placed further away.
7	RFOUT	RF Output and DC Feed. Connect to DC supply through a 220nH inductor. Connect to output load through a 0.01μF DC-blocking capacitor.
—	EP	Exposed Pad. Connect to PCB ground plane by a 3 x 3 array of vias. Connect to ground lead (1, 3, 6, 8) land patterns and to layer 1 ground plane with thermal relief traces.



## Detailed Description

### Adjustable Bias Control for the MAX2615

While the MAX2612/MAX2613/MAX2614/MAX2616 are fixed biased for ease of use, the MAX2615 allows the current to be controlled by an external bias resistor connected from R<sub>BIAS</sub> (pin 4) to ground. In this configuration, the MAX2615 can be used over a range of current settings with an upper limit of ~150mA for an R<sub>BIAS</sub> of 10k $\Omega$  and a lower limit of 37.5mA for an R<sub>BIAS</sub> of 69k $\Omega$ . Values within this range allow optimized performance and power consumption for customer requirements.

## Applications Information

### Wideband Designs

For LTE designs, the MAX261x family is ideally suited to minimize gain compensation over frequency while providing low noise and high OIP3 in a small (2mm x 3mm TDFN) but thermally efficient package. The same device can be used for multiple frequency bands without adjusting for gain slope degradation, a common artifact among pHEMT, InGaP, and GaAs gain blocks.

### Input Overload Handling

As a result of its simple Darlington architecture and rugged bipolar process, the MAX261x family provides an industry-leading +20dBm maximum input power rating. This inherently reduces the need for input protection circuitry while greatly minimizing the potential for damage to the device from intermittent RF surges.

## Ordering Information

PART	TEMP RANGE	PIN-PACKAGE
<b>MAX2612</b> ETA+	-40°C to +85°C	8 TDFN-EP*
<b>MAX2613</b> ETA+	-40°C to +85°C	8 TDFN-EP*
<b>MAX2614</b> ETA+	-40°C to +85°C	8 TDFN-EP*
<b>MAX2615</b> ETA+	-40°C to +85°C	8 TDFN-EP*
MAX2615ETA/V+	-40°C to +85°C	8 TDFN-EP*
<b>MAX2616</b> ETA+	-40°C to +85°C	8 TDFN-EP*

+Denotes a lead(Pb)-free/RoHS-compliant package.

\*EP = Exposed Pad.

V Denotes an automotive qualified part.

## Package Information

For the latest package outline information and land patterns (footprints), go to [www.maximintegrated.com/packages](http://www.maximintegrated.com/packages). Note that a "+", "#", or "-" in the package code indicates RoHS status only. Package drawings may show a different suffix character, but the drawing pertains to the package regardless of RoHS status.

PACKAGE TYPE	PACKAGE CODE	OUTLINE NO.	LAND PATTERN NO.
8 TDFN-EP	T823+1	<a href="#">21-0174</a>	<a href="#">90-0091</a>

## Revision History

REVISION NUMBER	REVISION DATE	DESCRIPTION	PAGES CHANGED
0	5/12	Initial release	—
1	2/14	Revised <i>Electrical Characteristics</i> notes and added the automotive package to the <i>Ordering Information</i>	4, 9
2	7/14	Fixed <i>Typical Operating Characteristics</i> error and <i>Pin Description</i>	6, 8
3	5/15	Updated <i>Package Information</i>	9

For pricing, delivery, and ordering information, please contact Maxim Direct at 1-888-629-4642, or visit Maxim Integrated's website at [www.maximintegrated.com](http://www.maximintegrated.com).

Maxim Integrated cannot assume responsibility for use of any circuitry other than circuitry entirely embodied in a Maxim Integrated product. No circuit patent licenses are implied. Maxim Integrated reserves the right to change the circuitry and specifications without notice at any time. The parametric values (min and max limits) shown in the *Electrical Characteristics* table are guaranteed. Other parametric values quoted in this data sheet are provided for guidance.