



Features

- 2" x 4" x 1.3" Package
- For 1U Applications
- 175W w/air, 120W convection cooled
- Universal Input 90-264Vac
- Average Efficiency meets Level V Requirements
- Approved to CSA/EN/IEC/UL60950, 2nd Edition
- 12V fan output
- Efficiency 90% typical at Full Load
- 3 Year Warranty
- RoHS Compliant



Description

A highly dense 175Watts AC to DC power supply designed for industrial and ITE applications. With convection rating of 120 Watts, CINT1175 family leads the market in power density and low leakage makes it a perfect solution for lighting applications. With input & output monitoring alarms plus isolated 12V/0.4A fan, it is one the most feature rich supplies and can easily fit in 1U chassis. All 5 models are CE marked to low voltage directive and approved to ITE standards of EN60950, 2nd edition.

Model Selection

Model Number	Volts	Output Current		Fan Output	Ripple & Noise**	Total Regulation	OVP*** Threshold***
		w/200LFM air	Convection				
CINT1175A1206K01	12V	14.6A	11.7A	12Vdc/0.4A	0.5%RMS, 1.2% pk-pk	±3%	14.0 ± 1.1V
CINT1175A1506K01	15V	11.7A	9.3A	12Vdc/0.4A	0.5%RMS, 1.0% pk-pk	±3%	18.5 ± 1.5V
CINT1175A2406K01	24V	7.3A	5.8A	12Vdc/0.4A	0.5%RMS, 1.2% pk-pk	±3%	28.0 ± 2.5V
CINT1175A4806K01	48V	3.6A	2.9A	12Vdc/0.4A	0.5%RMS, 1.0% pk-pk	±3%	55.0 ± 4.0V
CINT1175A5606K01	56V	3.1A	2.5A	12Vdc/0.4A	0.5%RMS, 1.0% pk-pk	±3%	59.0 ± 1.0V

Notes: * Total convection power is 120 Watts.

** Measured with noise probe directly across output terminals, and load terminated with 0.1µF ceramic and 10µF low ESR capacitors.

*** Output adjustment on 56V model will not exceed 56.2 volts.

General Specifications

AC Input	100-240Vac, ±10%, 47-63Hz, 1Ø 120-370Vdc	Turn On Time	Less than 2 sec. @115Vac (inversely proportional to input voltage and thermistor temperature)
Input Current	115Vac: 2A, 230Vac: 1A	Hold-up Time	16mS, typical
Inrush Current	264Vac, cold start: will not exceed 50A	Signals	AC Power Fail, DC OK

General Specifications (continued)

Input Fuses	F1, F2: 4A, 250Vac fuses provided on all models	Overload Protection	Hiccup Mode
Earth Leakage Current	<750 μ A@264Vac, 60Hz, NC	Short Circuit Protection	Provided - no damage will occur if the output is shorted.
Efficiency	90% typical at 115Vac	Overvoltage Protection	OVP firing reduces output voltage to <50% of nominal in <50ms. See chart for trip range.
Output Power	175W continuous, with 200 lfm airflow, 120W convection cooled – See chart for specific voltage model ratings.	Switching Frequency	PFC: Fixed, 65kHz Main Converter: Variable 35-200kHz, 65-70kHz at full load.
Transient Response	50% load step. $\Delta i/\Delta t$: <0.2A/ μ S Max Volt Deviation = 3%	Isolation	Input-Output: 4000Vac Input-Ground: 1800Vac Output-Ground: 1500Vac
Ripple and Noise	See chart	Operating Temperature	-10°C to +70°C Start Up at -40°C, full load
Output Voltage	See chart	Temperature Derating	Derate output power linearly above 50°C to 50% at 70°C
Voltage Adjustability	+/-5% from nominal	Storage Temperature	-40°C to +85°C
Minimum Load	Not required	Altitude	Operating: -500 to 10,000 ft. Non-operating: -500 to 40,000 ft.
Total Regulation	+/- 3%. See chart	Relative Humidity	5% to 95%, non-condensing
Vibration	Operating: 0.003g/Hz, 1.5grms overall, 3 axes, 10 min/axis Non-Operating: 0.026g ² /Hz, 5.0grms overall, 3 axes, 1 hr/axis	Shock	Operating: Half-sine, 20gpk, 10ms, 3 axes, 6 shocks total Non-Operating: Half-sine, 40 gpk, 10 ms, 3 axes, 6 shocks total
Dimensions	W: 2.0" x L: 4.0" x H: 1.3"	Safety Standards	EN/CSA/UL/IEC 60950-1, 2nd Edition
Weight	210g	MTBF	331,105 hours, 175W load, 110Vac input, 25°C ambient

Auxiliary Signals

AC Power Fail:	During normal operations, stays HIGH. Signal goes LOW with 5mS warning before loss of DC output from AC failure.	DC OK:	Open collector logic signal goes and stays HIGH 100mS to 500mS after main output reaches regulation.
Inhibit:	Connect to inhibit pin to output common to inhibit the DC output.		

EMI / EMC Compliance

Conducted Emissions	EN55011/22 Class B, FCC Part 15, Subpart B, Class B
Radiated Emissions	EN55011/22 Class A, FCC Part 15, Subpart B, Class A w/6db margin
Static Discharge Immunity	EN61000-4-2, Criteria A, 6kV Contact Discharge, 8kV air discharge
Radiated RF Immunity	EN61000-4-3, 3V/m. Criteria A
EFT/Burst Immunity	EN61000-4-4, 2kV/5kHz, Criteria A
Line Surge Immunity	EN61000-4-5, 1kV differential, 2kV common-mode, Criteria A
Conducted RF Immunity	EN61000-4-6, 3Vrms, Criteria A
Power Frequency Magnetic Field Immunity	EN61000-4-8, 3A/m, Criteria A
Voltage Dip Immunity	EN61000-4-11, 0% Vin, 0.5cycle; 40% Vin, 5 cycles; 70% Vin, 25 cycles; Criteria A
Line Harmonic Emissions	EN61000-3-2, Class A, B, C, & D
Flicker Test	EN61000-3-3, Complies (dmax<6%)

Mechanical Drawing

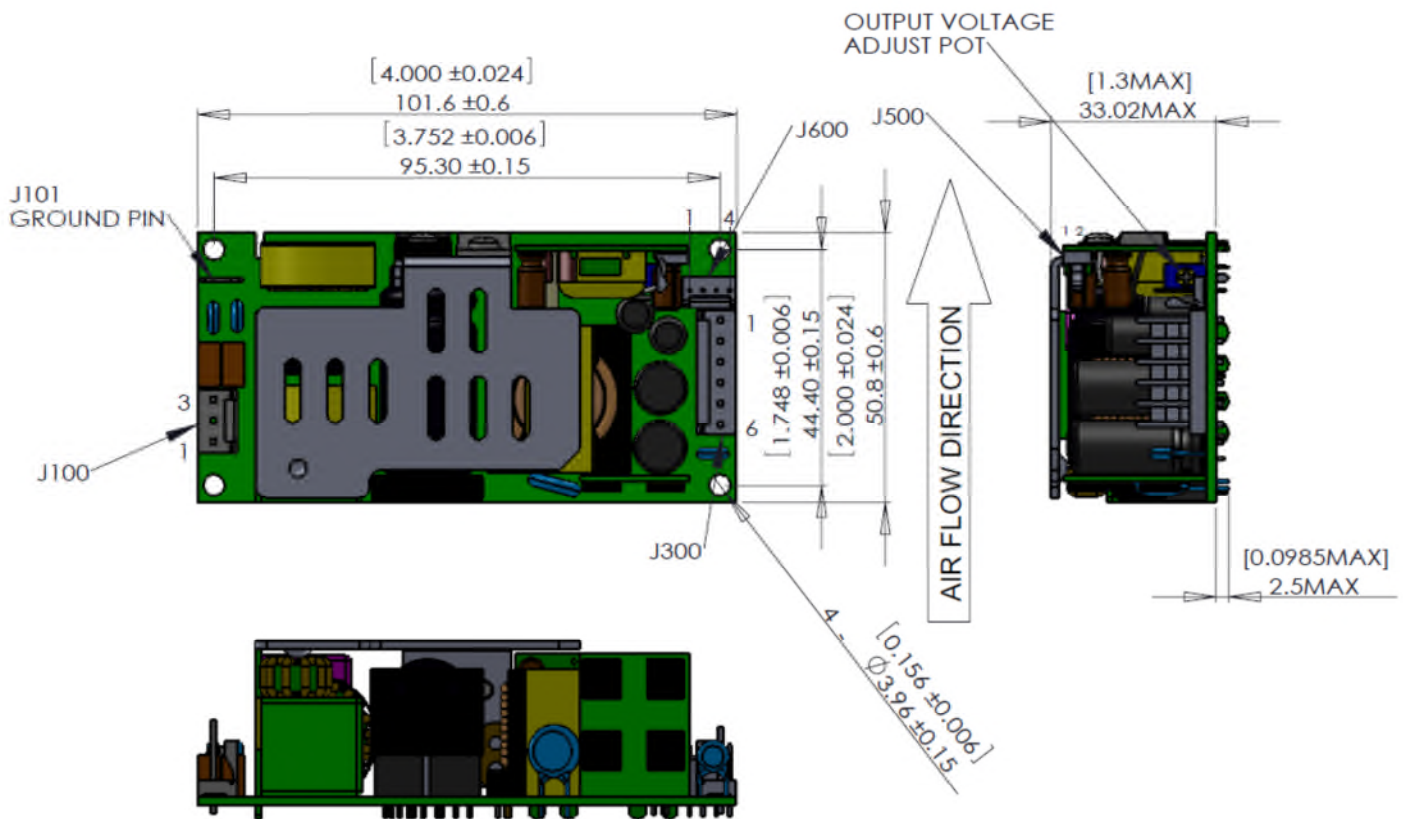

Connector Information

Input Connector J100	Ground J101	DC Output Connector J300	Fan Output Connector J500	Signal Connector J600
PIN 1) AC LINE PIN 2) EMPTY PIN 3) AC NEUTRAL	0.25" FASTON TAB	PIN 1) +Vout PIN 4) -Vout PIN 2) +Vout PIN 5) -Vout PIN 3) +Vout PIN 6) -Vout	PIN 1) +12Vfan PIN 2) RTN	PIN 1) Inhibit PIN 2) PF/DC OK PIN 3, 4) Common
Mating Connector: Molex 09-50-3031 Pins= 08-52-0072	Mating Connector: Molex 01-90020009	Mating Connector: AMP 640250-6 Pins = 640252-1	Mating Connector: Molex 1375820-2 Pins = 1375819	Mating Connector: Molex 1375820-4 Pins = 1375819

Fan Output – J500

J500 provides a 12V@0.4mA output to support a system cooling fan. The fan output is always available when AC input is present, so it also can be used for a 12V standby output is so desired.

AC Power Failure/DC OK and Inhibit Signals – J600

AC Power Failure/DC OK

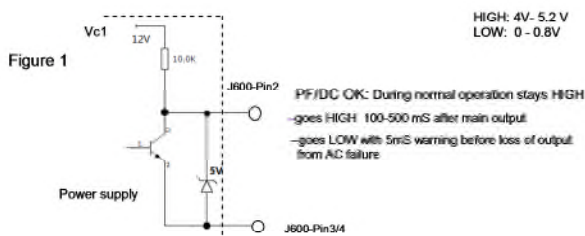

AC Power failure and DC OK signals use the same pin ,so the signals can be used as follows:

DC OK: Pin2 = HIGH & Pin1 = HIGH AC Power Failure: Pin2 = LOW & Pin1 = LOW

Inhibit

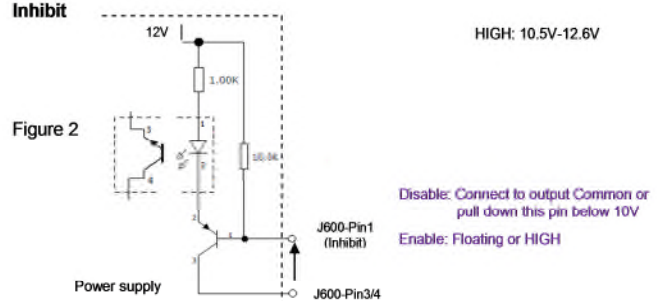

Timing Sequence

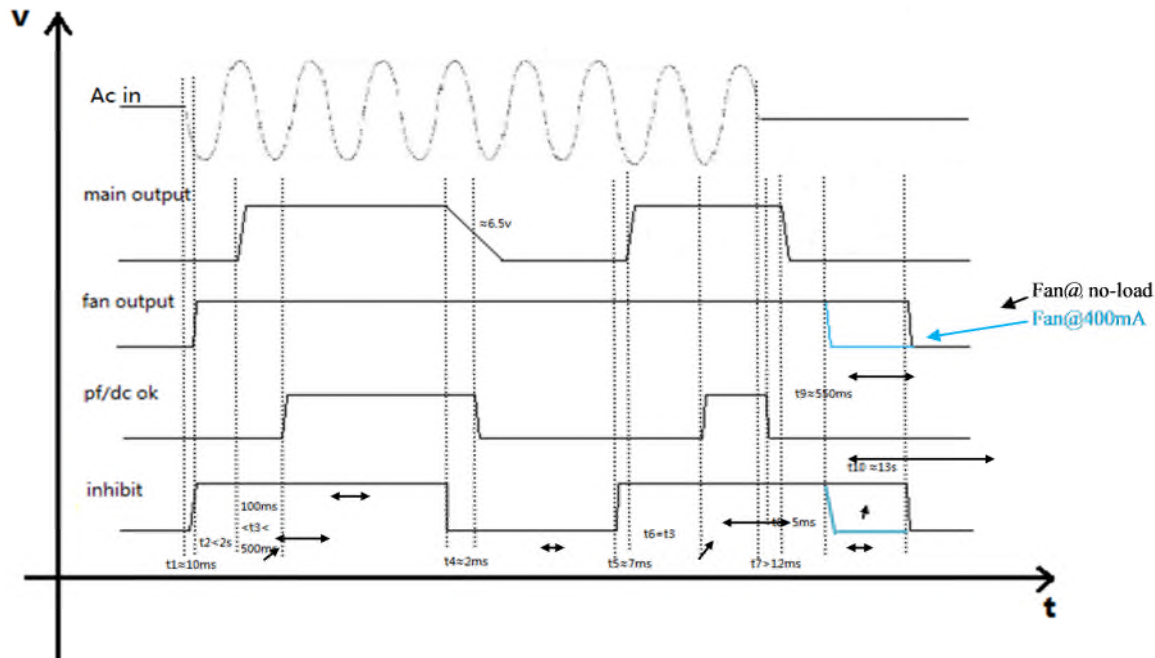

Isolation Specifications

Parameter	Conditions/Description	Min	Nom	Max	Units
Insulation Safety Rating	Input/Ground Input/Output Output/Ground	Basic Reinforced n/a			
Electric Strength Test Voltage	Input/Ground Input/Output Output/Ground	1800 4000 1500	-	-	Vac Vac Vac

Input Specifications

All specifications apply over specified input voltage, output load, and temperature range, unless otherwise noted.

Parameter	Conditions/Description	Min	Nom	Max	Units
Input Voltage		90	115/230	264	Vac
Turn-On Input Voltage	Ramping up		82.7		Vac
Turn-Off Input Voltage	Ramping down		67.0		Vac
Input Frequency		47	50/60	63	Hz
Inrush Current Limitation	264Vac, cold start	-	-	50	A
Power Factor	$V_{i\ nom}, I_{o\ nom}$	0.9	-	-	
Efficiency	$V_{i\ nom}, I_{o\ nom}$ CINT1175A1206K01 CINT1175A1506K01 CINT1175A2406K01 CINT1175A4806K01 CINT1175A5606K01	-	90%	-	%

Output Specifications

Parameter	Conditions/Description	Min	Nom	Max	Units
Output Voltage Setpoint Accuracy CINT1175A1206K01	$V_{i\ nom}, I_{o1}$ @ ADC, $TC = 25\ ^\circ C$	-3	-	3	% $V_{o\ nom}$
Output Voltage Setpoint Accuracy CINT1175A1506K01	$V_{i\ nom}, I_{o1}$ @ ADC, $TC = 25\ ^\circ C$	-3	-	3	% $V_{o\ nom}$
Output Voltage Setpoint Accuracy CINT1175A2406K01	$V_{i\ nom}, I_{o1}$ @ ADC, $TC = 25\ ^\circ C$	-3	-	3	% $V_{o\ nom}$
Output Voltage Setpoint Accuracy CINT1175A4806K01	$V_{i\ nom}, I_{o1}$ @ ADC, $TC = 25\ ^\circ C$	-3	-	3	% $V_{o\ nom}$
Output Voltage Setpoint Accuracy CINT1175A5606K01	$V_{i\ nom}, I_{o1}$ @ ADC, $TC = 25\ ^\circ C$	-3	-	3	% $V_{o\ nom}$
Output Current V1 Output Current V2	CINT1175A1206K01	0 0	10.0 -	14.6 0.4	ADC ADC
Output Current V1 Output Current V2	CINT1175A1506K01	0 0	8.0 -	11.7 0.4	ADC ADC
Output Current V1 Output Current V2	CINT1175A2406K01	0 0	5.0 -	7.3 0.4	ADC ADC
Output Current V1 Output Current V2	CINT1175A4806K01	0 0	2.5 -	3.6 0.4	ADC ADC
Output Current V1 Output Current V2	CINT1175A5606K01	0 0	2.1 -	3.1 0.4	ADC ADC
Static Line Regulation V1	$V_{i\ min} - V_{i\ max}, V_{i\ nom}, 0-100\% I_{o\ nom}$	-1	-	1	% $V_{o\ nom}$
Static Load Regulation V1 (Droop Characteristic)	$V_{i\ min} - V_{i\ max}, V_{i\ nom}, 0-100\% I_{o\ nom}$	-3	-	3	% $V_{o\ nom}$

Output Specifications (continued)

Parameter	Conditions/Description	Min	Nom	Max	Units
Hold-Up Time	Starting at $V_i = 230$ VAC, P_o nom	-	16	-	ms
Dynamic Load Regulation	Load change =50%, $di/dt = 0.2A/\mu S$ voltage deviation 3%	0		3	% V_o nom
Start-Up Time	V_i nom, I_o nom	0	-	2	s

Protection

All specifications apply over specified input voltage, output load, and temperature range, unless otherwise noted

Parameter	Conditions/Description	Min	Nom	Max	Units
Input Fuse	Not user accessible				
Input Transient Protection	2KV(CM) and 1KV(DM) surge			2	KV (CM)
Output	No-load and short circuit proof	Hiccup or Latch			
	short circuit proof	Hiccup or Latch			
	overload (latch style)	Hiccup			
Overvoltage Protection	Latch style	Latch			
Over temperature Protection	Automatic power shutdown at $T_C = 155^\circ C$				

Characteristic Curves

Output vs. Temperature

120W convection cooled and 175W continuous with 200 LFM airflow, Derating output power to 50% at $70^\circ C$.

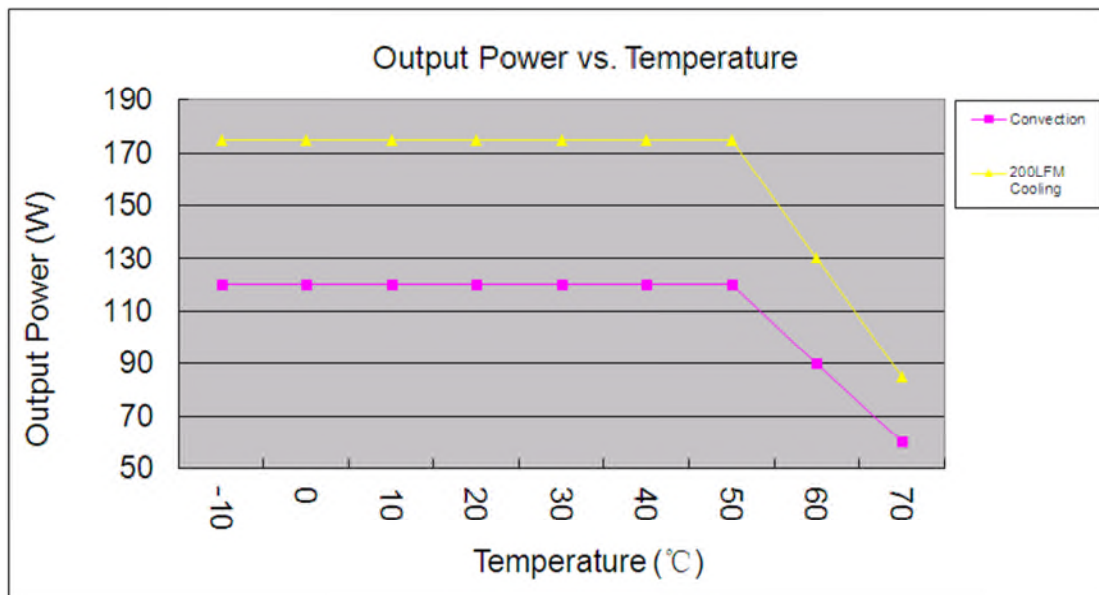

Efficiency vs. Loading

The high efficiency is achieved by using LLC technology, PFC topology minimizing switching losses. Synchronous SCHOTTKY or ultra-fast diode is used as rectifier in CINT1175 family because of high output voltage level.

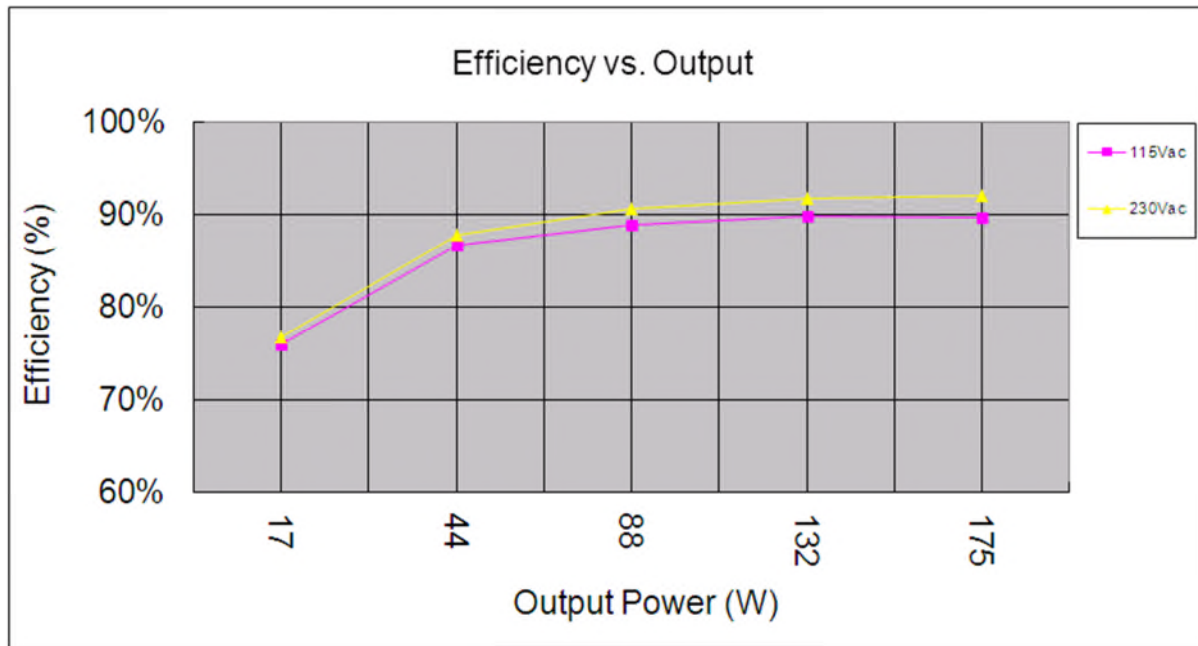

Noise & Ripple

To verify that the output ripple and noise does not exceed the level specified in the product specification. Measured using a scope probe socket with 0.1uF ceramic and a 10uF electrolysis capacitor connected in parallel across it, BW limit with 20MHz.

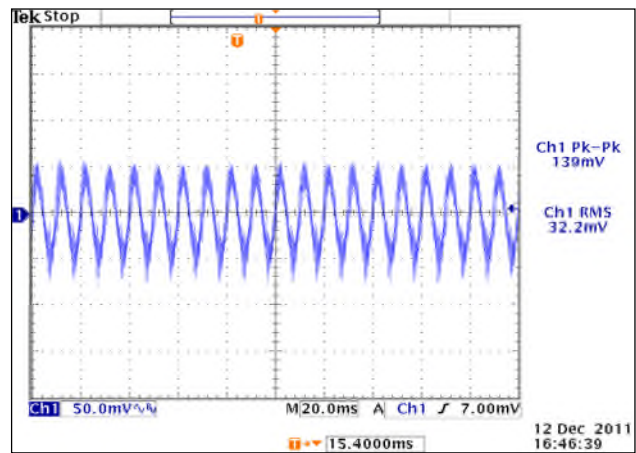
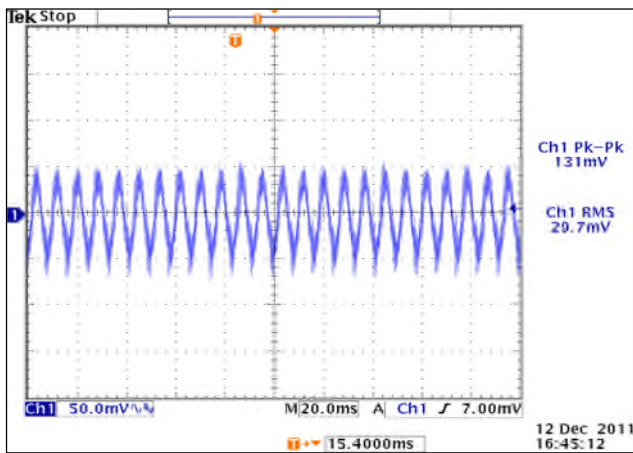

Output Transient Response

50% load step within the regulation limits of minimum and maximum load, $di/dt < 0.2A/\mu\text{Sec}$. Recovery time not specified as there is no laps in regulation with a 50% Load Step. Maximum voltage deviation is 3%, This test is performed on the MAIN OUTPUT ONLY.

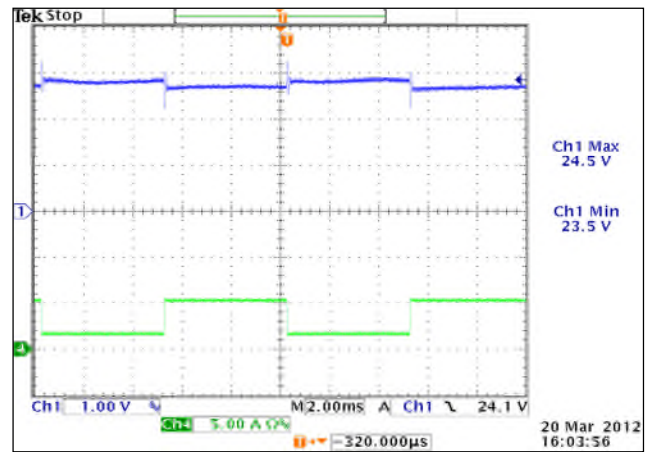
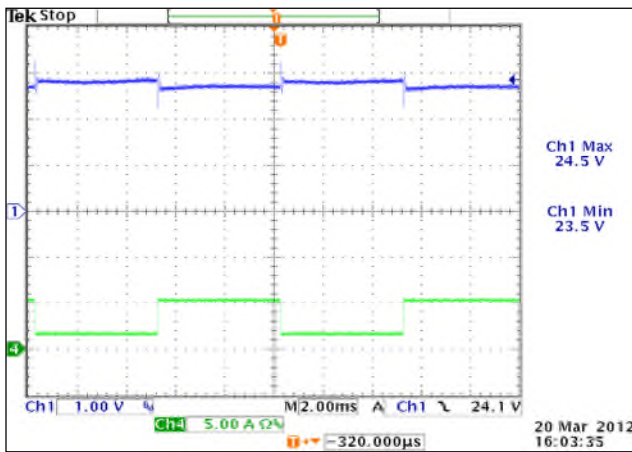

Output Overload Characteristic

Supply shall protect itself against Overload conditions. The Power Supply shall recover from Overload Conditions without operator intervention.

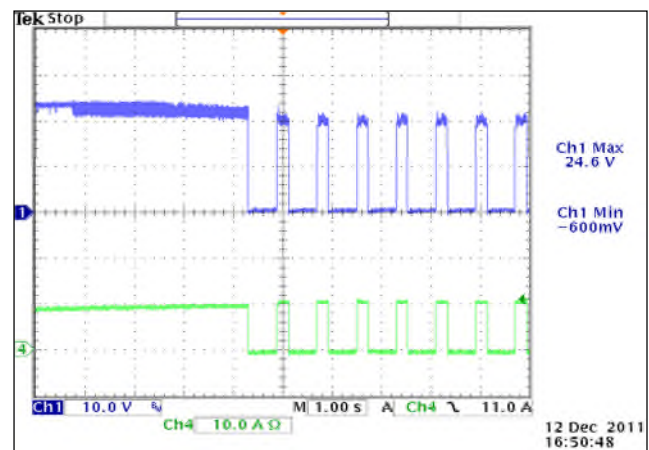
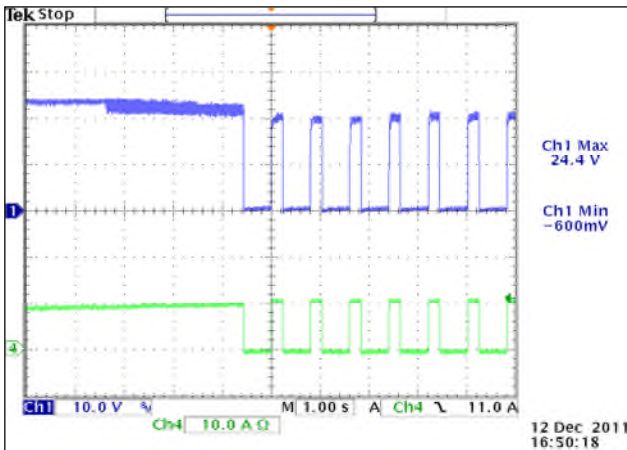

Output Overshoot

When supply is turned on, off or when the load is stepped 100%, the Power Supply Overshoot/Undershoot shall not exceed minimum or maximum of output voltage regulation.

