

CBM-360 LEDs



Table of Contents

Technology Overview	2
Test Specifications	2
White Binning Structure	3
Chromaticity Bins	4
Product Shipping & Labeling Information	5
Electrical Characteristics	6
Lifetime & Lumen Maintenance	7
Spectral Characteristics	7
Radiation Patterns	8
Thermal Resistance	9
Mechanical Dimensions	10
Ordering Information	11

Features:

- Extremely high optical output: Over 5,000 lumens from a single package (white)
- High thermal conductivity package - junction to heat sink thermal resistance of only 0.96°C/W
- Four large, monolithic chips with uniform emitting area of 36 mm²
- Unencapsulated die with low profile protective window optimizes optical coupling in etendue-limited applications
- Lumen maintenance of greater than 70% after 60,000 hours
- Variable drive current: less than 1 A through 6.3 A
- High reliability
- Environmentally friendly: RoHS compliant

Applications

- | | |
|--|------------------|
| • Fiber-coupled Illumination | • Machine Vision |
| • Architectural and Entertainment Lighting | • Microscopy |
| • Medical Lighting | • Transportation |

Technology Overview

Luminus Big Chip LEDs™ benefit from a suite of innovations in the fields of chip technology, packaging and thermal management. These breakthroughs allow illumination engineers and designers to achieve solutions that are high brightness and high efficiency.

Luminus Technology

Luminus' technology enables large area LED chips with uniform brightness over the entire LED chip surface. The optical power and brightness produced by these large monolithic chips enable solutions which replace arc and halogen lamps where arrays of traditional high power LEDs cannot.

Packaging Technology

Thermal management is critical in high power LED applications. With a thermal resistance from junction to heat sink of 0.96° C/W, Luminus CBM-360 LEDs have the lowest thermal resistance of any LED on the market. This allows the LED to be driven at higher current densities while maintaining a low junction temperature, thereby resulting in brighter solutions and longer lifetimes.

Reliability

Designed from the ground up, Luminus Big Chip LEDs are one of the most reliable light sources in the world today. Big Chip LEDs have passed a rigorous suite of environmental and mechanical stress tests, including mechanical shock, vibration, temperature cycling and humidity, and have been fully qualified for use in extreme high power and high current applications. With very low failure rates and median lifetimes that typically exceed 60,000 hours, Luminus Big Chip LEDs are ready for even the most demanding applications.

Environmental Benefits

Luminus LEDs help reduce power consumption and the amount of hazardous waste entering the environment. All Big Chip LED products manufactured by Luminus are RoHS compliant and free of hazardous materials, including lead and mercury.

Understanding Big Chip LED Test Specifications

Every Luminus LED is fully tested to ensure that it meets the high quality standards expected from Luminus' products.

Testing Temperature

Luminus core board products are typically measured in such a way that the characteristics reported agree with how the devices will actually perform when incorporated into a system. This measurement is accomplished by mounting the devices on a 40°C heat sink and allowing the device to reach thermal equilibrium while fully powered. Only after the device reaches equilibrium are the measurements taken. This method of measurement ensures that Luminus Big Chip LEDs perform in the field just as they are specified.

Expected flux values in real world operation can be extrapolated based on the information contained within this product data sheet.

Multiple Operating Points

The tables on the following pages provide typical optical and electrical characteristics. Since the LEDs can be operated over a wide range of drive conditions (currents from less than 1A to 6.3A, and duty cycle from <1% to 100%), multiple drive conditions are possible.

CBM-360 LEDs are production tested at 6.3 A.

CBM-360 White Binning Structure

CBM-360 LEDs are tested for luminous flux and chromaticity at a drive current of 6.3 A (0.7A/mm²) and placed into one of the following luminous flux (FF) and chromaticity (WW) bins:

Flux Bins

Color	Flux Bin (FF)	Minimum Flux (lm) @ 6.3A	Maximum Flux (lm) @ 6.3A
W65S 6500K, Standard CRI (typ. 70)	VB	4,550	4,860
	WA	4,860	5,225

*Note: Luminus maintains a +/- 6% tolerance on flux measurements.

Chromaticity Bins

Luminus' Standard Chromaticity Bins: 1931 CIE Curve

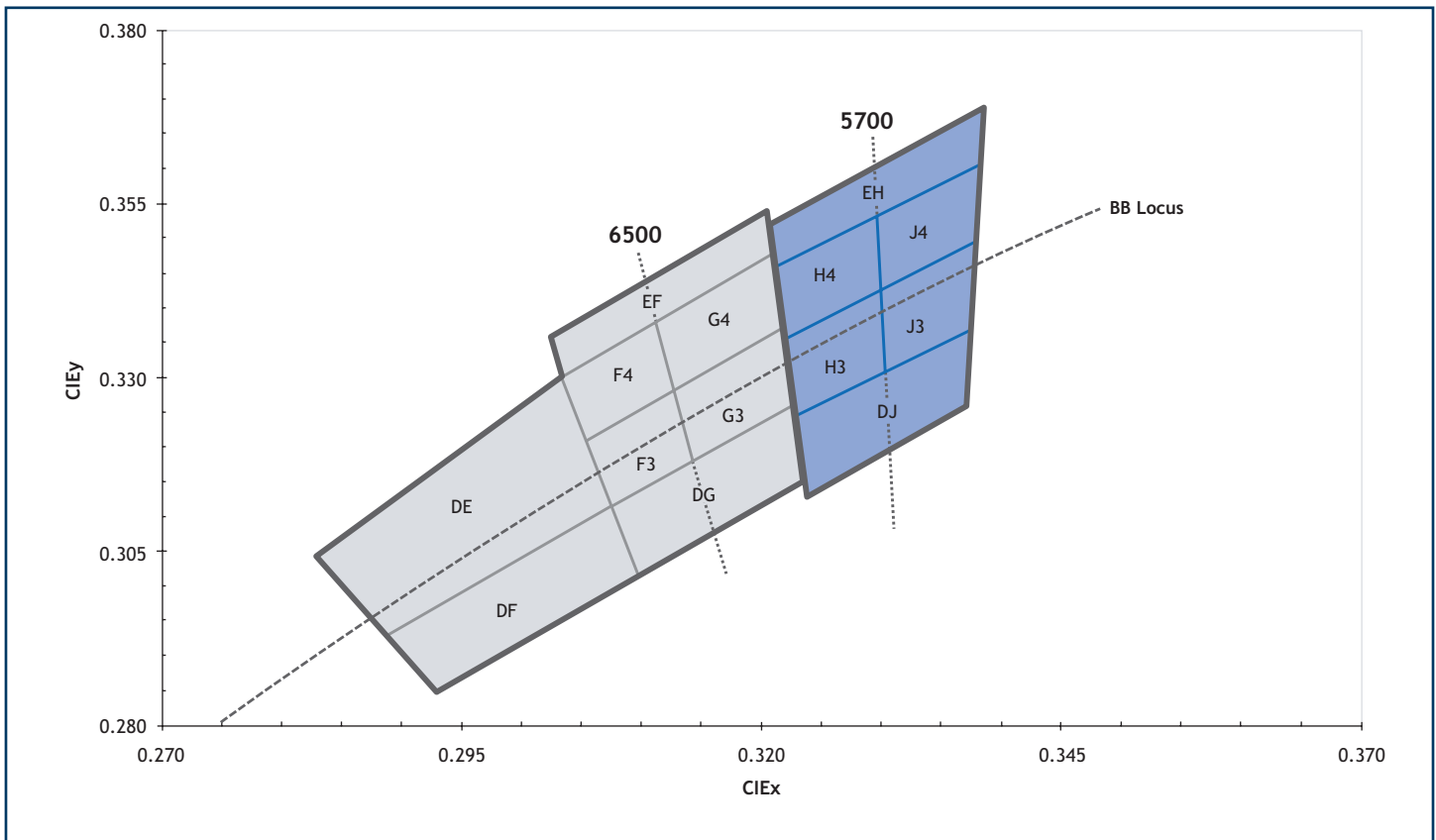

The following tables describe the four chromaticity points that bound each chromaticity bin. Chromaticity bins are grouped together based on the color temperature.

6500K Chromaticity Bins		
Bin Code (WW)	CIEx	CIEy
DG	0.307	0.311
	0.322	0.326
	0.323	0.316
	0.309	0.302
F3*	0.305	0.321
	0.313	0.329
	0.315	0.319
	0.307	0.311
F4*	0.303	0.330
	0.312	0.339
	0.313	0.329
	0.305	0.321
G3*	0.313	0.329
	0.321	0.337
	0.322	0.326
	0.315	0.319
G4*	0.312	0.339
	0.321	0.348
	0.321	0.337
	0.313	0.329
EF	0.302	0.335
	0.320	0.354
	0.321	0.348
	0.303	0.330

5700K Chromaticity Bins		
Bin Code (WW)	CIEx	CIEy
DJ	0.322	0.324
	0.337	0.337
	0.336	0.326
	0.323	0.314
H3*	0.321	0.335
	0.329	0.342
	0.329	0.331
	0.322	0.324
H4*	0.321	0.346
	0.329	0.354
	0.329	0.342
	0.321	0.335
J3*	0.329	0.342
	0.337	0.349
	0.337	0.337
	0.330	0.331
J4*	0.329	0.354
	0.338	0.362
	0.337	0.349
	0.329	0.342
EH	0.320	0.352
	0.338	0.368
	0.338	0.362
	0.321	0.346

*Sub-bins within ANSI defined quadrangles per ANSI C78.377-2008

Product Shipping & Labeling Information

All CBM-360 LED products are packaged and labeled with their respective bin as outlined in the tables on pages 3 & 4. When shipped, each package will only contain one bin. The part number designation is as follows:

CBM — 360 — WNNX — D32 — FF — WW

Product Family	Chip Area	Color	Package Configuration	Flux Bin	Chromaticity Bin
Chip on Board (window)	36.0 mm ²	CCT & CRI See Note 1 below	Internal Code	See page 3 for bins	See page 4 for bins

Note 1: WNNX nomenclature corresponds to the following:

W = White

NN = color temperature, where:

65 corresponds to 6500K

X = color rendering index, where:

S (standard) corresponds to a typical CRI of 70

Note 2: Some flux and chromaticity bins may have limited availability. Application specific bin kits, consisting of multiple bins, may be available. For ordering information, please refer to page 11 and reference PDS-001834: CBM-360 Binning & Labeling document.

Example:

The part number CBM-360-W65S-D32-VB-G4 refers to a 6500 standard CRI white, CBM-360 emitter, with a flux range of 4,550-4,860 lumens and a chromaticity value within the box defined by the four points (0.313, 0.338), (0.321, 0.348), (0.322, 0.336), (0.312, 0.328).

Electrical Characteristics¹

Optical and Electrical Characteristics ($T_{\text{heat sink}} = 40\text{ }^{\circ}\text{C}$)

Drive Condition ²		6.3 A Continuous	
Parameter	Symbol	Specifications at Test Currents ³	Unit
Current Density	j	0.70	A/mm ²
Forward Voltage	$V_{F, \text{min}}$	12.8	V
	$V_{F, \text{typ}}$	14.4	V
	$V_{F, \text{max}}$	16.0	V

Common Characteristics

Parameter	Symbol	Values	Unit
Emitting Area		36.0	mm ²
Emitting Area Dimensions		6 x 6	mm×mm
Color Temperature ⁴	CCT	6,500	K
Color Rendering Index (Typical)	R_a	>70	
Forward Voltage Temperature Coefficient ⁴		-3.07	mV/°C

Absolute Maximum Ratings

Parameter	Symbol	Values	Unit
Maximum Current ⁵		6.3	A
Maximum Junction Temperature ⁶	$T_{J, \text{max}}$	150	°C
Storage Temperature Range		-40/+100	°C

- Note 1: All ratings are based on operation with a constant heat sink temperature $T_{\text{hs}} = 40^{\circ}\text{C}$. See Thermal Resistance section for T_{hs} definition.
- Note 2: Listed drive conditions are typical for common applications. CBM-360-White devices can be driven at currents ranging from 1A to 6.3A and at duty cycles ranging from 1% to 100%. Drive current and duty cycle should be adjusted as necessary to maintain the junction temperature desired to meet application lifetime requirements.
- Note 3: Unless otherwise noted, values listed are typical.
- Note 4: CCT value based off of CIE measurement. CIE measurement uncertainty for white devices is estimated to be +/- 0.01.
- Note 5: Forward voltage temperature coefficient at current density of 0.70 A/mm². Contact Luminus for value at other drive conditions.
- Note 6: CBM-360-White LED™ are designed for operation to an absolute maximum forward drive current density of 0.7 A/mm². Product lifetime data is specified at recommended forward drive currents. Sustained operation at absolute maximum currents will result in a reduction of device lifetime compared to recommended forward drive currents. Actual device lifetimes will also depend on junction temperature. Refer to the lifetime derating curves for further information. In pulsed operation, rise time from 10-90% of forward current should be larger than 0.5 microseconds.
- Note 7: Lifetime dependent on LED junction temperature. Input power and thermal system must be properly managed to ensure lifetime. See charts on pg 7 for further information.
- Note 8: Special design considerations must be observed for operation under 1 A. Please contact Luminus for further information.
- Note 9: Caution must be taken not to stare at the light emitted from these LEDs. Under special circumstances, the high intensity could damage the eye.

Relative Output Flux vs. Forward Current¹

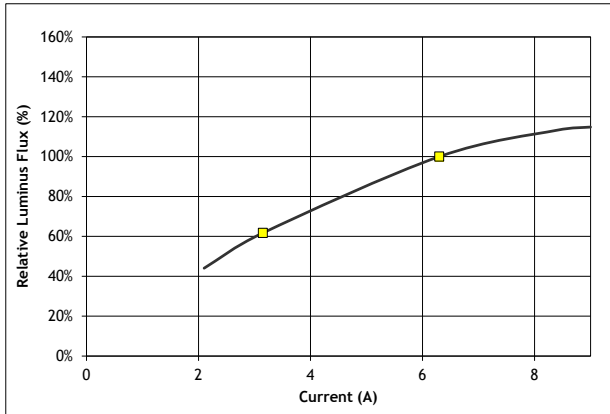

Forward Current vs. Forward Voltage

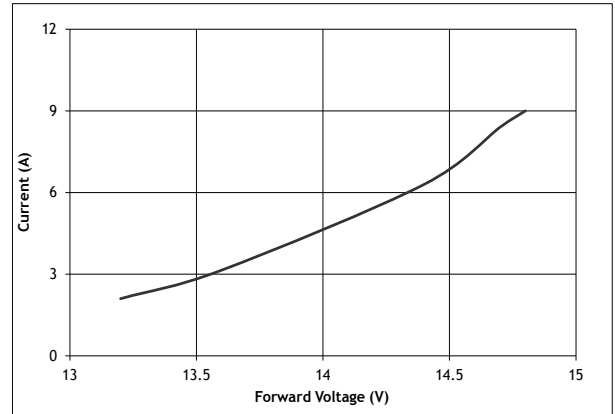

Mean Lifetime²

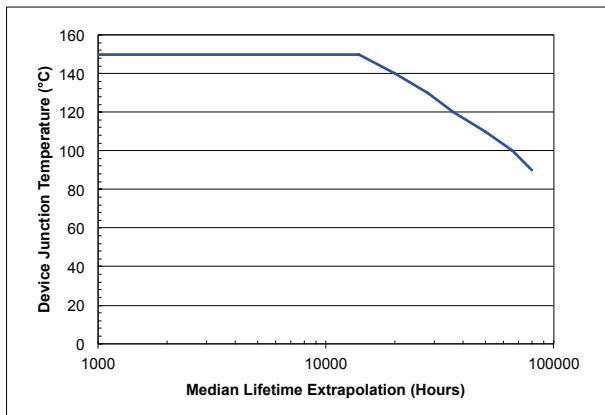

Lumen Maintenance vs. Time³

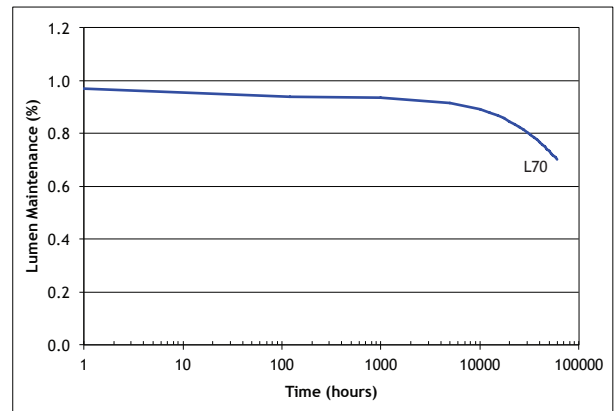

Typical Spectrum⁴

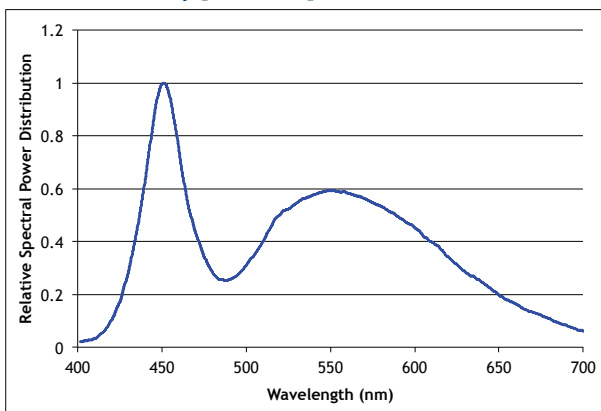

Current Derating Curve

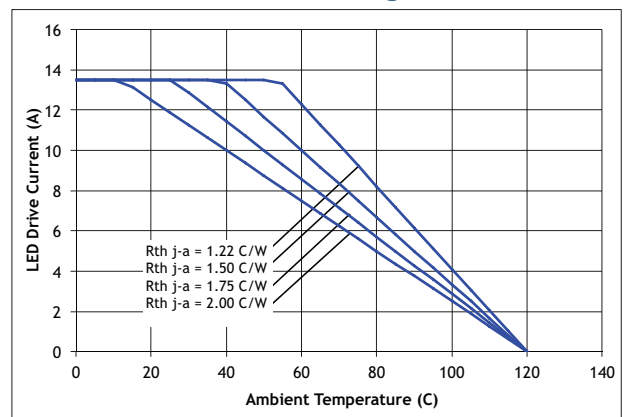

Note 1: Yellow squares indicate typical operating conditions.

Note 2: Mean expected lifetime in dependence of junction temperature at 0.70 A/mm² in continuous operation. Lifetime defined as time to 70% of initial intensity. Based on lifetime test data. Data can be used to model failure rate over typical product lifetime (contact Luminus for lifetime reliability test data for 1A/mm² condition).

Note 3: Lumen maintenance in dependence of time at 0.70A/mm² in continuous operation with junction temperatures of 100 °C.

Note 4: Typical spectrum at current density of 0.70 A/mm² in continuous operation.

Relative Luminous Flux vs. Junction Temperature

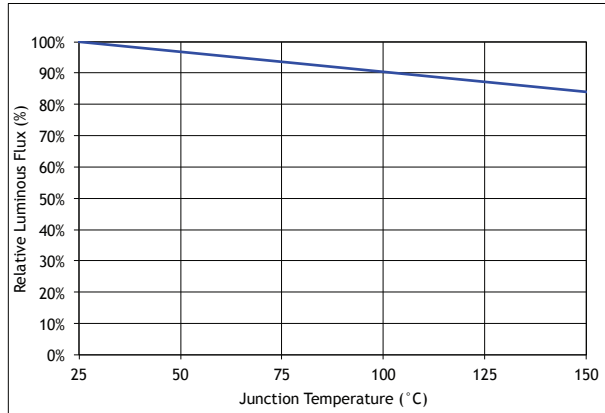

Typical Radiation Patterns

Typical Polar Radiation Pattern for White

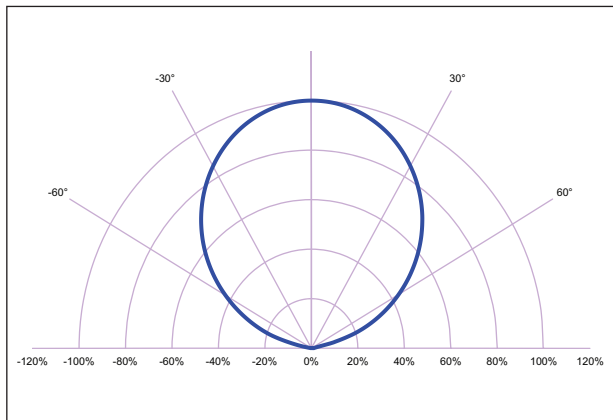

Typical Angular Radiation Pattern for White

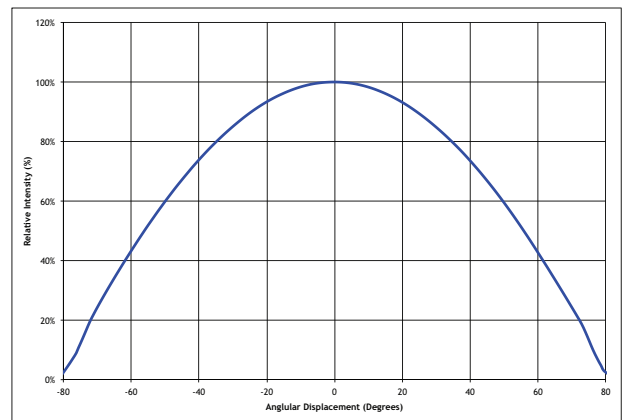

Thermal Resistance

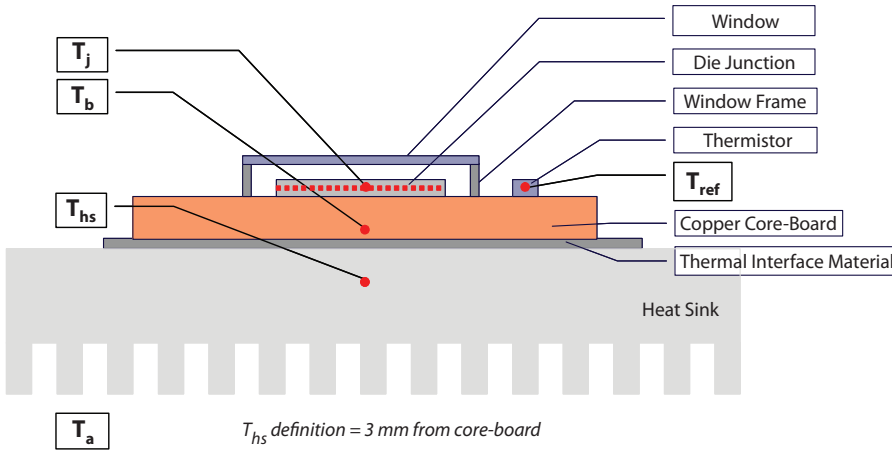

Typical Thermal Resistance

$R_{\theta j-b}^{-1}$	0.83 °C/W
$R_{\theta b-hs}^{-1}$	0.13 °C/W
$R_{\theta j-hs}^{-2}$	0.96 °C/W
$R_{\theta j-ref}^{-1}$	0.69 °C/W

Note 1: Thermal resistance values are based on FEA model results correlated to measured $R_{\theta j-hs}$ data.

Note 2: Thermal resistance is measured using eGraf 1205 thermal interface material.

Thermistor Information

The thermistor used in CBM-360 mounted on core-boards is from Murata Manufacturing Co. The global part number is NCP18XH103J03RB. Please see <http://www.murata.com/> for details on calculating thermistor temperature.

Electrical Pinout

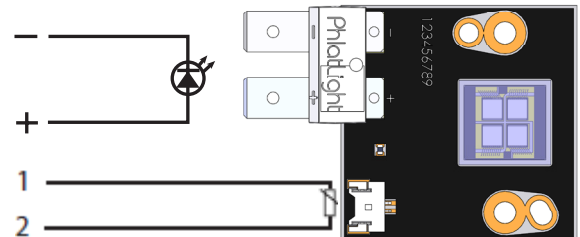

Mechanical Dimensions – CBM-360-W Emitter

DIMENSIONS IN MILLIMETERS

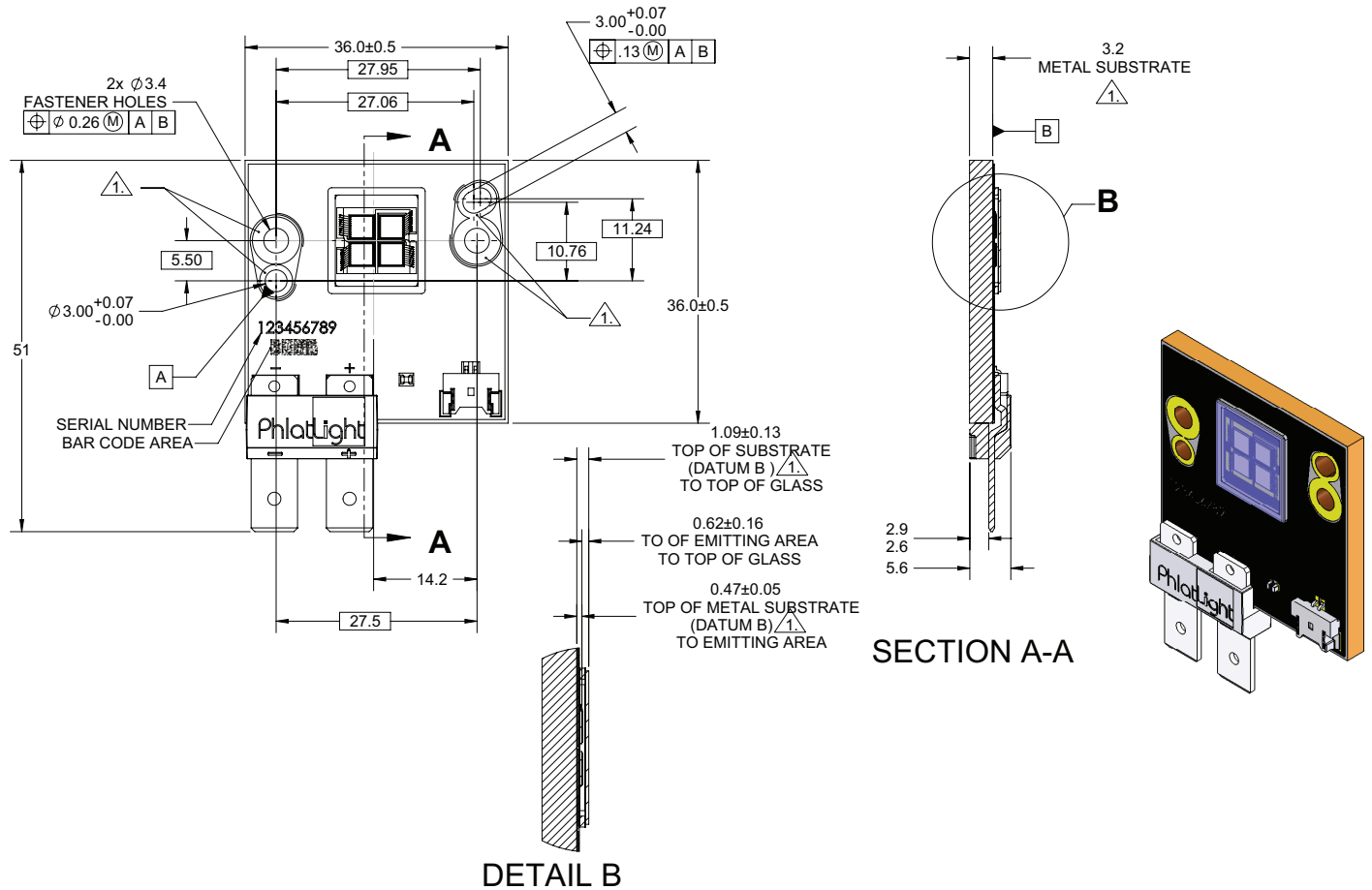

Recommended connector ERNI MaxBridge p/n 284117
 For detailed drawing please refer to DWG-001246 document

Ordering Information

Ordering Part Number ^{1,2}	Color	Description
CBM-360-WDLS-D32-VB150	6500K White 5700K White	CBM-360 white Big Chip LED™ consisting of four 9 mm ² LEDs wired in series, thermistor, and 2-pin connector, on a copper-core PCB

Note 1: VB150 - denotes a bin kit comprising of all flux bins with a minimum flux of 4,550 lumens and chromaticity bins at the 6500K color point.

Note 2: For ordering information on all available bin kits, please see PDS-001834: CBM-360 Binning & Labeling document.

Note 3: Standard packaging increment (SPI) is 10 for D32 configuration.

The products, their specifications and other information appearing in this document are subject to change by Luminus Devices without notice. Luminus Devices assumes no liability for errors that may appear in this document, and no liability otherwise arising from the application or use of the product or information contained herein. None of the information provided herein should be considered to be a representation of the fitness or suitability of the product for any particular application or as any other form of warranty. Luminus Devices' product warranties are limited to only such warranties as accompany a purchase contract or purchase order for such products. Nothing herein is to be construed as constituting an additional warranty. No information contained in this publication may be considered as a waiver by Luminus Devices of any intellectual property rights that Luminus Devices may have in such information. Big Chip LEDs™ is a registered trademark of Luminus Devices, Inc., all rights reserved.

This product is protected by U.S. Patents 6,831,302; 7,074,631; 7,083,993; 7,084,434; 7,098,589; 7,105,861; 7,138,666; 7,166,870; 7,166,871; 7,170,100; 7,196,354; 7,211,831; 7,262,550; 7,274,043; 7,301,271; 7,341,880; 7,344,903; 7,345,416; 7,348,603; 7,388,233; 7,391,059 Patents Pending in the U.S. and other countries.