

REVISIONS				
REV.	ECO. NO.	DESCRIPTION	DATE	BY
A	1244	INITIAL RELEASE	1/15/2007	MV
B	2465	ADDED 'B' MOUNTING, 38-POSITION, UPDATED PROCESSING TIME FOR G & J MTL CODES	10/05/2011	JH
C	3439	ADD -S38, -S81, -S328 MODIFICATION OPTIONS, UPDATE DWG FORMAT, UPDATE BOM ON PRODUCTION DWG, UPDATE PRODUCT FAMILY SPECIFICATIONS, UPDATE MATERIAL SPECIFICATIONS, ADD MATERIAL COLOR TO P/N CODING	5/12/2016	MG

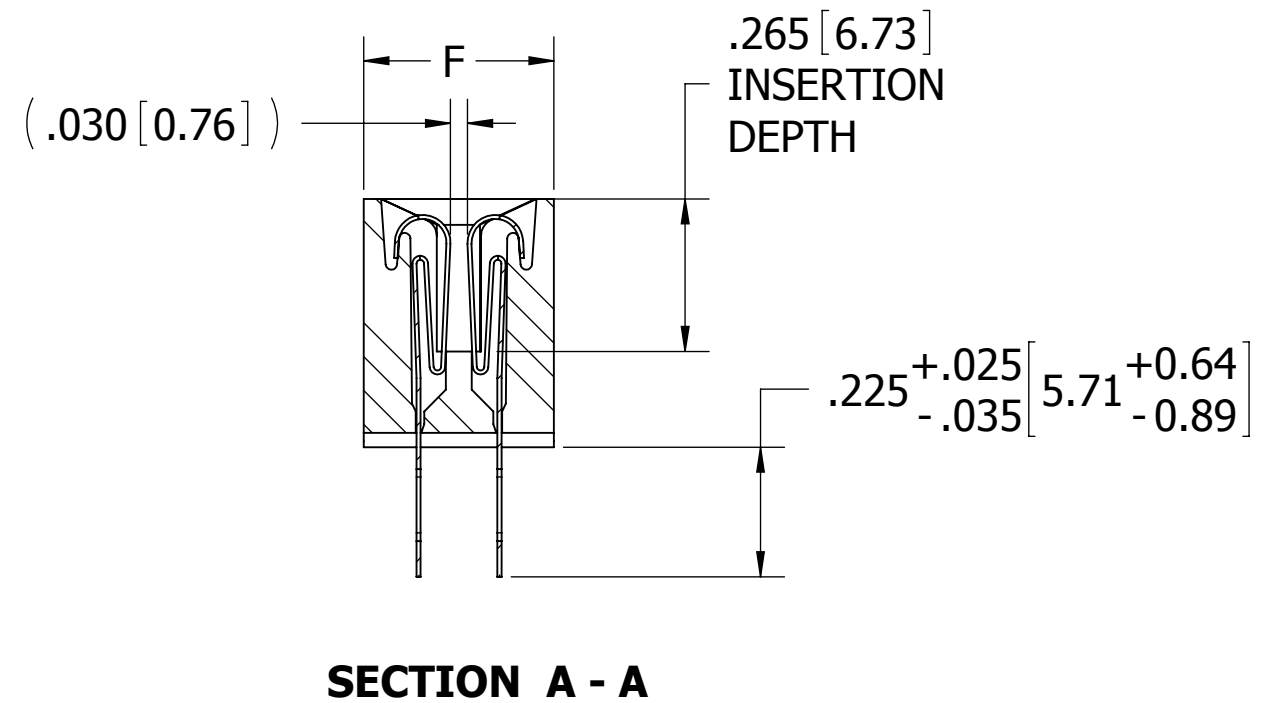

- NOTES:
1. INSULATOR MATERIAL: SEE PART NUMBER CODING
  2. CONTACT MATERIAL: SEE PART NUMBER CODING
  3. PLATING: SEE PART NUMBER CODING
  4. OPERATING TEMPERATURE: SEE PART NUMBER CODING
  5. PROCESSING TEMP: SEE PART NUMBER CODING
  6. UL FLAMMABILITY RATING: 94V-0
  7. OPERATING VOLTAGE: 700 VAC
  8. CURRENT RATING: 3 AMP
  9. CONTACT RESISTANCE: 30 MILLI OHMS MAX
  10. INSULATION RESISTANCE: 5000 MEGA OHMS
  11. DURABILITY: 500 CYCLES MINIMUM
  12. CONNECTOR IDENTIFICATION: THE PART SHALL BE MARKED WITH A PART NUMBER AND LOT CODE
  13. BOARD THICKNESS ACCOMMODATED: .062 ± .008 [1.57 ± 0.20]
  14. INSERTION FORCE: 16 OZ MAX PER CONTACT PAIR WHEN USING A .062 [1.57] TEST BLADE  
INTERNAL INSPECTION TO BE PER SULLINS WORK INSTRUCTION WI7.3-01
  15. WITHDRAWAL FORCE: 1 OZ MIN PER CONTACT PAIR USING .062 [1.57] TEST BLADE
  16. MODIFICATION: SEE PART NUMBER CODING

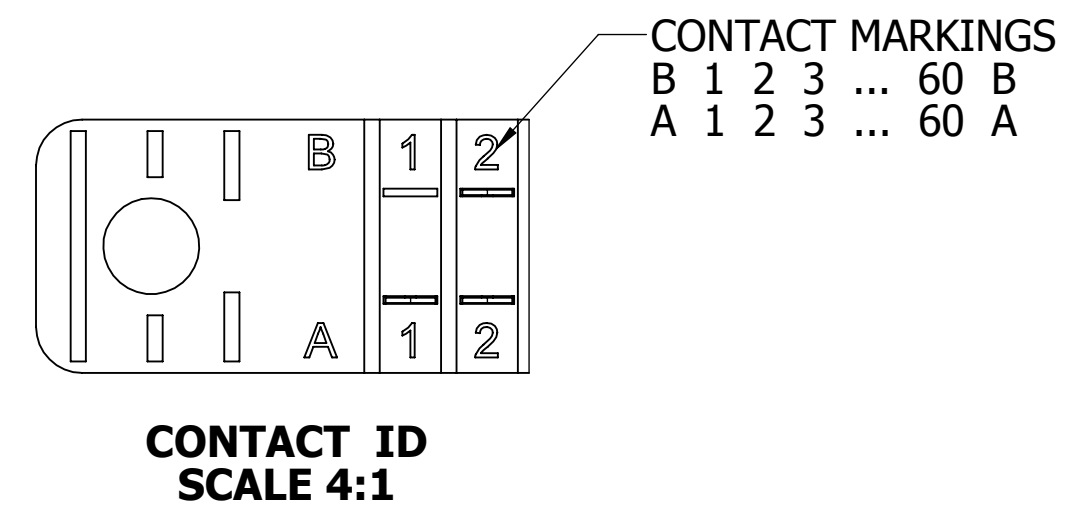
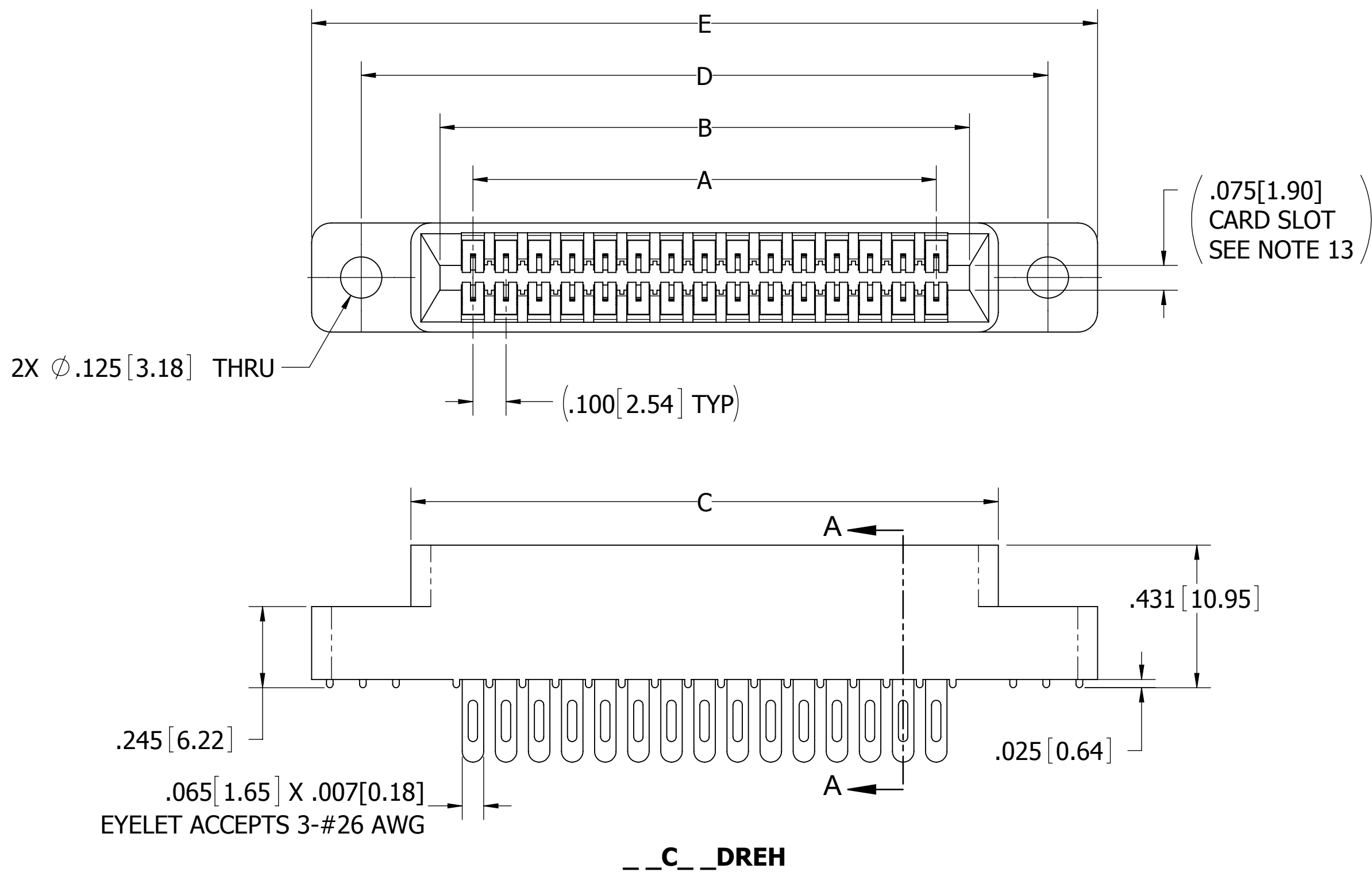

**CUSTOMER COPY**

UNLESS OTHERWISE SPECIFIED: DIMENSIONS ARE IN INCHES [MM]		DRAWN	DATE	NAME	
			10/4/2011	JH	
TOLERANCES:					<small>THE INFORMATION HEREIN CONTAINS PROPRIETARY INFORMATION OF SULLINS ELECTRONICS AND IS NOT TO BE REPRODUCED, USED OR DISCLOSED TO OTHERS FOR ANY PURPOSE EXCEPT AS SPECIFICALLY AUTHORIZED IN WRITING BY AN OFFICER OF SULLINS ELECTRONICS.</small>
ANGULAR: ± 1°					
DECIMALS .XX = ± .02 [.5] .XXX = ± .005 [.13] .XXXX = ± .0005 [.013]					
TITLE		EDGE CARD, .100 CC LP			
PART NUMBER		_C_DRE_(OMIT,-S38,-S81,-S328)			
SIZE	CAGE CODE	DWG. NO.	REV		
C	54453	C10870	C		
SCALE: 2:1		SHEET 1 OF 3			

2X #4-40  
THREADED  
INSERTS

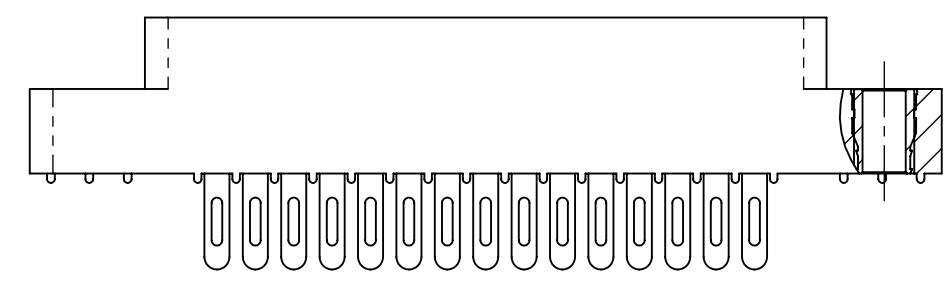
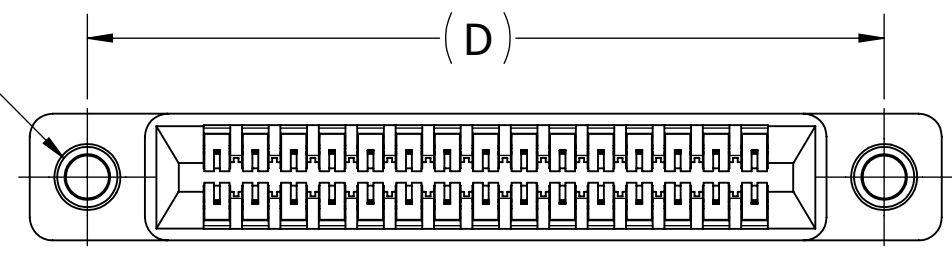

\_\_C\_\_DREI

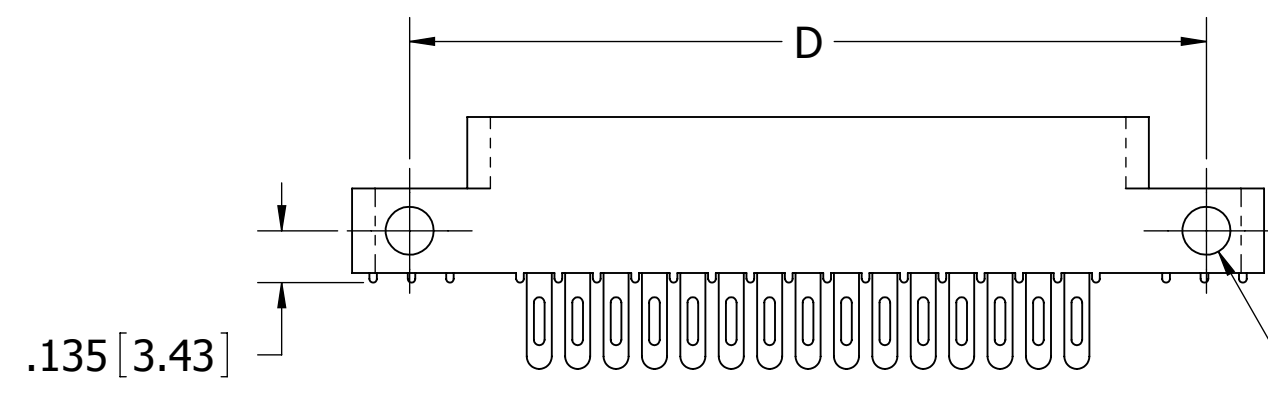
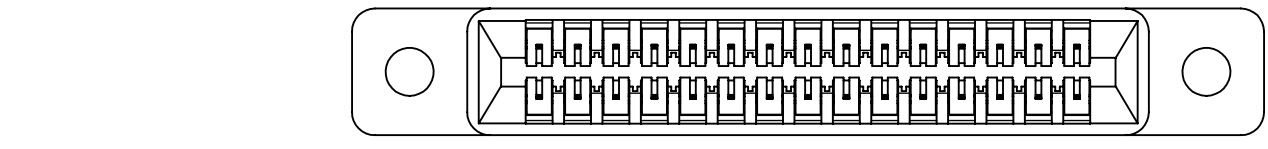

\_\_C\_\_DRES

2X FLOATING BOBBIN  
Ø .116 [2.95] CLEARANCE  
FOR # 4 SCREW

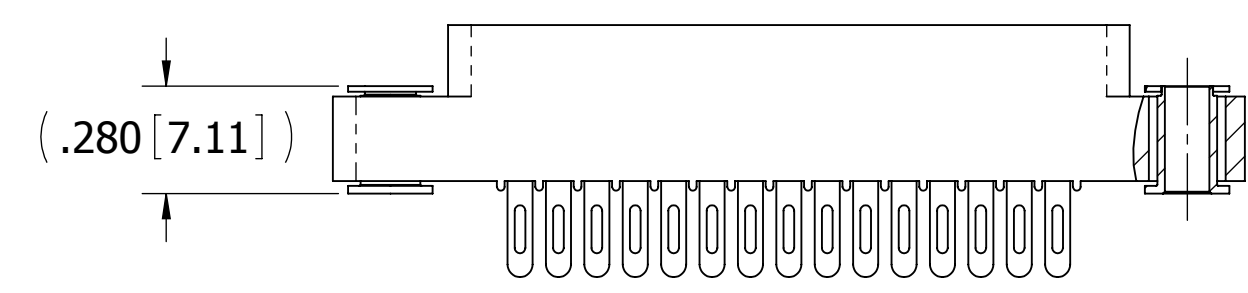
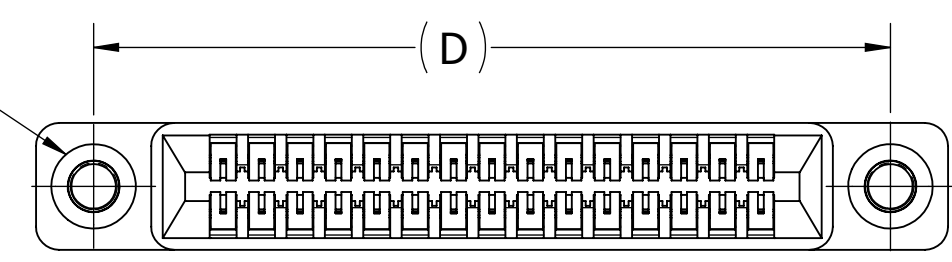

\_\_C\_\_DREF

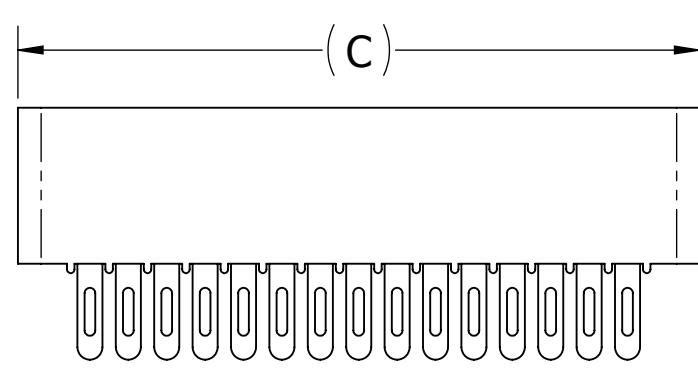
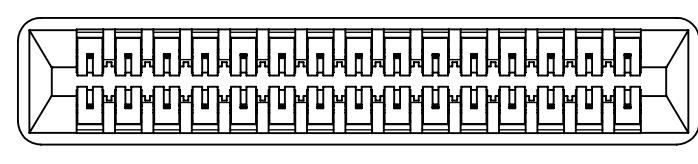

\_\_C\_\_DREN

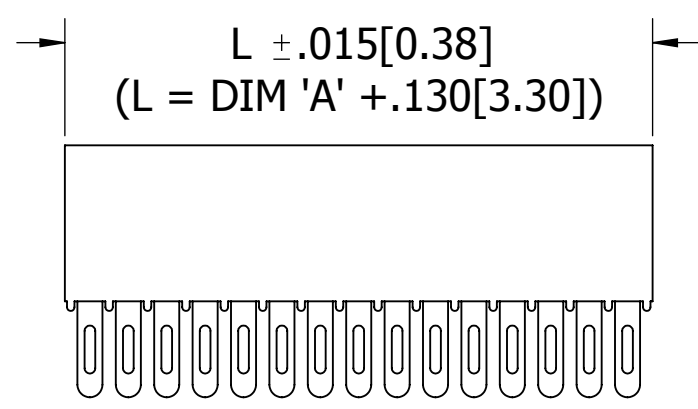
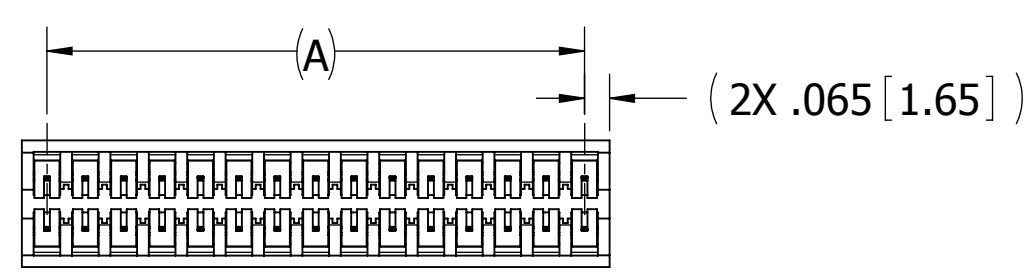

\_\_C\_\_DREB

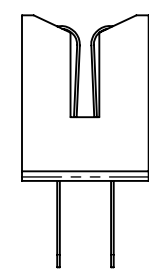

# CUSTOMER COPY



UNLESS OTHERWISE SPECIFIED: DIMENSIONS ARE IN INCHES [MM]	DRAWN	DATE	NAME	
		10/4/2011	JH	
<b>TOLERANCES:</b> ANGULAR: ± 1°  <b>DECIMALS</b> .XX = ± .02 [.5] .XXX = ± .005 [.13] .XXXX = ± .0005 [.013]	<small>THE INFORMATION HEREIN CONTAINS PROPRIETARY INFORMATION OF SULLINS ELECTRONICS AND IS NOT TO BE REPRODUCED, USED OR DISCLOSED TO OTHERS FOR ANY PURPOSE EXCEPT AS SPECIFICALLY AUTHORIZED IN WRITING BY AN OFFICER OF SULLINS ELECTRONICS.</small>			TITLE
				EDGE CARD, .100 CC LP
				PART NUMBER
				__C__DRE_(OMIT,-S38,-S81,-S328)
SIZE	CAGE CODE	DWG. NO.	REV	
C	54453	C10870	C	
SCALE: 2:1			SHEET 2 OF 3	

PART NUMBER	NO. OF POS.	A±.008[0.20]		B±.008[0.20]		C±.015[0.38]		D±.010[0.25]		E±.020[0.51]		F±.005[0.13] -.015[0.38]	
		IN	MM	IN	MM	IN	MM	IN	MM	IN	MM	IN	MM
C04DRE -S	4	0.300	7.62	0.500	12.70	0.675	17.15	0.975	24.77	1.275	32.39	0.330	8.38
C05DRE -S	5	0.400	10.16	0.600	15.24	0.775	19.69	1.075	27.31	1.375	34.93		
C06DRE -S	6	0.500	12.70	0.700	17.78	0.875	22.23	1.175	29.85	1.475	37.47		
C07DRE -S	7	0.600	15.24	0.800	20.32	0.975	24.77	1.275	32.39	1.575	40.01		
C08DRE -S	8	0.700	17.78	0.900	22.86	1.075	27.31	1.375	34.93	1.675	42.55		
C10DRE -S	10	0.900	22.86	1.100	27.94	1.275	32.39	1.575	40.01	1.875	47.63		
C12DRE -S	12	1.100	27.94	1.300	33.02	1.475	37.47	1.775	45.09	2.075	52.71		
C13DRE -S	13	1.200	30.48	1.400	35.56	1.575	40.01	1.875	47.63	2.175	55.25		
C15DRE -S	15	1.400	35.56	1.600	40.64	1.775	45.09	2.075	52.71	2.375	60.33		
C17DRE -S	17	1.600	40.64	1.800	45.72	1.975	50.17	2.275	57.79	2.575	65.41		
C18DRE -S	18	1.700	43.18	1.900	48.26	2.075	52.71	2.375	60.33	2.675	67.95		
C19DRE -S	19	1.800	45.72	2.000	50.80	2.175	55.25	2.475	62.87	2.775	70.49		
C20DRE -S	20	1.900	48.26	2.100	53.34	2.275	57.79	2.575	65.41	2.875	73.03		
C22DRE -S	22	2.100	53.34	2.300	58.42	2.475	62.87	2.775	70.49	3.075	78.11		
C23DRE -S	23	2.200	55.88	2.400	60.96	2.575	65.41	2.875	73.03	3.175	80.65		
C25DRE -S	25	2.400	60.96	2.600	66.04	2.775	70.49	3.075	78.11	3.375	85.73		
C26DRE -S	26	2.500	63.50	2.700	68.58	2.875	73.03	3.175	80.65	3.475	88.27		
C28DRE -S	28	2.700	68.58	2.900	73.66	3.075	78.11	3.375	85.73	3.675	93.35		
C30DRE -S	30	2.900	73.66	3.100	78.74	3.275	83.19	3.575	90.81	3.875	98.43		
C31DRE -S	31	3.000	76.20	3.200	81.28	3.375	85.73	3.675	93.35	3.975	100.97		
C35DRE -S	35	3.400	86.36	3.600	91.44	3.775	95.89	4.075	103.51	4.375	111.13		
C36DRE -S	36	3.500	88.90	3.700	93.98	3.875	98.43	4.175	106.05	4.475	113.67		
C38DRE -S	38	3.700	93.98	"B" MOUNTING ONLY									
C40DRE -S	40	3.900	99.06	4.100	104.14	4.275	108.59	4.575	116.21	4.875	123.83	0.400	10.16
C43DRE -S	43	4.200	106.68	4.400	111.76	4.575	116.21	4.875	123.83	5.175	131.45		
C44DRE -S	44	4.300	109.22	4.500	114.30	4.675	118.75	4.975	126.37	5.275	133.99		
C49DRE -S	49	4.800	121.92	5.000	127.00	5.175	131.45	5.475	139.07	5.775	146.69		
C50DRE -S	50	4.900	124.46	5.100	129.54	5.275	133.99	5.575	141.61	5.875	149.23		
C52DRE -S	52	5.100	129.54	5.300	134.62	5.475	139.07	5.775	146.69	6.075	154.31		
C60DRE -S	60	5.900	149.86	6.100	154.94	6.275	159.39	6.575	167.01	6.875	174.63		
C65DRE -S	65	6.400	162.56	6.600	167.64	6.775	172.09	7.075	179.71	7.375	187.33		

**PART NUMBER CODING**

**MATERIAL (INSULATOR/CONTACT)**

- E = BLUE PBT/PHOSPHOR BRONZE**  
OPERATING TEMP: -65°C TO +125°C  
PROCESSING TEMP: WAVE/MANUAL SOLDERING ONLY
- R = GREEN PPS/PHOSPHOR BRONZE**  
OPERATING TEMP: -65°C TO +125°C  
PROCESSING TEMP: 260°C MAX FOR 20 SECS
- G = BLACK PA9T/PHOSPHOR BRONZE**  
OPERATING TEMP: -65°C TO +125°C  
PROCESSING TEMP: 260°C MAX FOR 20 SECS
- H = BLUE PBT/BERYLLIUM COPPER**  
OPERATING TEMP: -65°C TO +125°C  
PROCESSING TEMP: WAVE/MANUAL SOLDERING ONLY
- A = GREEN PPS/BERYLLIUM COPPER**  
OPERATING TEMP: -65°C TO +150°C  
PROCESSING TEMP: 260°C MAX FOR 20 SECS
- J = BLACK PA9T/BERYLLIUM COPPER**  
OPERATING TEMP: -65°C TO +150°C  
PROCESSING TEMP: 260°C MAX FOR 20 SECS
- F = GREEN PPS/SPINODAL (CONSULT FACTORY)**  
OPERATING TEMP: -65°C TO +200°C  
(CONSULT FACTORY FOR SPECIAL SOLDERING REQUIREMENTS)  
AVAILABLE IN OVERALL GOLD ONLY (S OR M PLATING CODE)
- C = GREEN PPS/BERYLLIUM NICKEL (CONSULT FACTORY)**  
OPERATING TEMP: -65°C TO +200°C  
PROCESSING TEMP: 260°C MAX FOR 20 SECS  
AVAILABLE IN OVERALL GOLD ONLY (S OR M PLATING CODE)
- W = NATURAL BROWN PEEK/BERYLLIUM NICKEL (CONSULT FACTORY)**  
OPERATING TEMP: -65°C TO +250°C  
PROCESSING TEMP: 260°C MAX FOR 20 SECS  
AVAILABLE IN OVERALL GOLD ONLY (M PLATING CODE)

**MODIFICATION**

- OMIT FOR STANDARD, EX: EBC15DREH
- S38 = BLACK PBT (MATERIAL CODES E AND H ONLY)
- S81 = GREEN PBT (MATERIAL CODES E AND H ONLY)
- S328 = BROWN PPS (MATERIAL CODES R, A, F, C ONLY)

**MOUNTING STYLE**

- H = .125" DIA. CLEARANCE HOLES
- I = #4-40 THREADED INSERT
- S = .125" DIA. SIDE MOUNTING
- N = NO MOUNTING EARS
- F = FLOATING BOBBIN
- B = OPEN CARD SLOT

**NUMBER OF POSITIONS (CONTACTS PER ROW)**

**PLATING**

ALL PLATINGS ARE LEAD FREE AND HAVE .000050" NICKEL UNDERPLATE

- |                                |                                   |
|--------------------------------|-----------------------------------|
| CONTACT SURFACE                | TERMINATION                       |
| G = .000010" GOLD              | .000005" GOLD                     |
| Y = .000030" GOLD              | .000005" GOLD                     |
| B = .000010" GOLD              | .000100" PURE TIN, MATTE          |
| C = .000030" GOLD              | .000100" PURE TIN, MATTE          |
| **E = .000100" PURE TIN, MATTE | .000100" PURE TIN, MATTE, OVERALL |
| S = .000010" GOLD              | .000010" GOLD OVERALL             |
| M = .000030" GOLD              | .000010" GOLD OVERALL             |
- \*\* OVERALL TIN ONLY AVAILABLE ON MATERIAL CODES E, R AND G

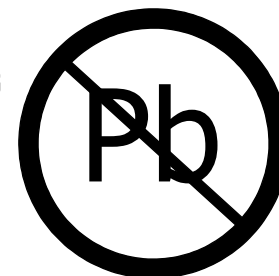
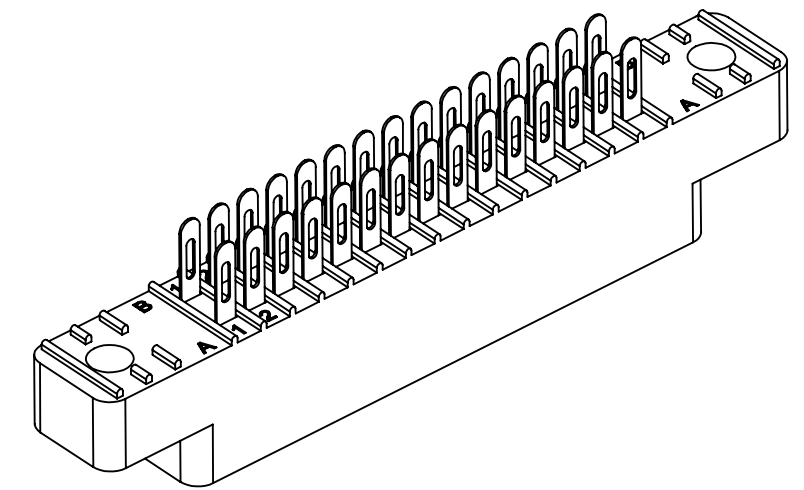

RoHS COMPLIANT

**CUSTOMER COPY**

UNLESS OTHERWISE SPECIFIED: DIMENSIONS ARE IN INCHES [MM]		DRAWN	DATE	NAME	
			10/4/2011	JH	
TOLERANCES: ANGULAR: ± 1° DECIMALS .XX = ± .02 [.5] .XXX = ± .005 [.13] .XXXX = ± .0005 [.013]					TITLE <b>EDGE CARD, .100 CC LP</b>
THE INFORMATION HEREIN CONTAINS PROPRIETARY INFORMATION OF SULLINS ELECTRONICS AND IS NOT TO BE REPRODUCED, USED OR DISCLOSED TO OTHERS FOR ANY PURPOSE EXCEPT AS SPECIFICALLY AUTHORIZED IN WRITING BY AN OFFICER OF SULLINS ELECTRONICS.					PART NUMBER <b>C_DRE_(OMIT,-S38,-S81,-S328)</b>
SIZE	CAGE CODE	DWG. NO.	REV		
C	54453	C10870	C		
SCALE: 2:1					SHEET 3 OF 3