

ASMT-TWBM-Nxxxx

Surface Mount LED Indicator



Data Sheet



Lead (Pb) Free
RoHS 6 fully
compliant



Description

Avago Technologies' ASMT-TWBM-Nxxxx Mini PLCC-2 SMT LEDs are designed specifically for use in Automotive Interior applications. They have a wide viewing angle of 110° making them ideally suited for instrument cluster panel, push button, HVAC and ambient decorative lighting applications in automotive interiors.

The LEDs are packed in EIA-compliant tape and reel to facilitate easy pick and place assembly. Every reel will be shipped in single intensity and color bin, to provide close uniformity.

Features

- Industry standard Mini PLCC-2
- High reliability LED package
- High brightness using InGaN dice technologies
- High optical efficiency
- Wide viewing angle at 110°
- Available is 8mm carrier tape on 7-inch reel
- Stable & consistent performance with minimum degradation
- JEDEC MSL 2

Applications

- Interior automotive
 - Instrument panel backlighting
 - Central console backlighting
 - Navigation and audio system backlighting
 - Push button backlighting
 - Ambient illumination
 - Car puddle lighting

CAUTION: ASMT-TWBM-Nxxxx LED is Class 1B ESD sensitive. Please observe appropriate precautions during handling and processing. Refer to Avago Application Note AN-1142 for additional details.

Package Dimensions

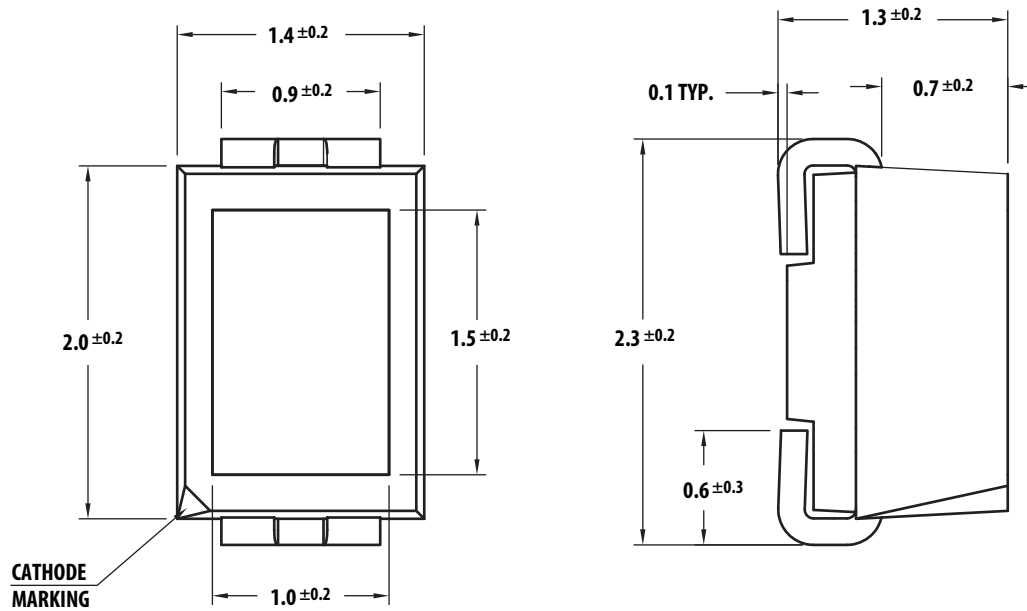

Notes:

1. All dimensions in millimeters.
2. Terminal Finish: Ag plating.
3. Encapsulation material: Silicone resin.

Figure 1. Package Drawing

Table 1. Device Selection Guide

Color	Part Number	Min. I_v (mcd)	Typ. I_v (mcd)	Max. I_v (mcd)	Test Current (mA)	Dice Technology
Cool White	ASMT-TWBM-NT902	355.0	650.0	1125.0	20	InGaN

Notes:

1. The luminous intensity I_v is measured at the mechanical axis of the lamp package. The actual peak of the spatial radiation pattern may not be aligned with this axis.
2. Tolerance = $\pm 12\%$

Part Numbering System

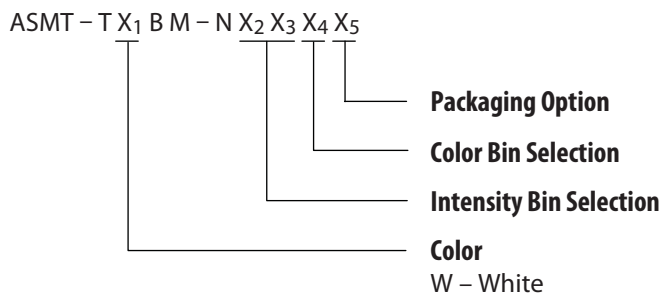

Table 2. Absolute Maximum Ratings ($T_A = 25^\circ\text{C}$)

Parameters	ASMT-TWBM-Nxxxx
DC Forward Current ^[1]	20 mA
Peak Forward Current ^[2]	100 mA
Power Dissipation	72 mW
Reverse Voltage, V_R @ 10 μA	Not Recommended for Reverse Bias
Junction Temperature	110°C
Operating Temperature	-40°C to +100°C
Storage Temperature	-40°C to +100°C

Notes:

1. Derate Linearly as shown in Figure 6.
2. Duty Factor = 10%, Frequency = 1kHz

Table 3. Optical Characteristics ($T_J = 25^\circ\text{C}$)

Color	Part Number	Dice Technology	Typical Chromaticity Coordinates ^[1]		Viewing Angle $2\theta_{1/2}$ ^[2] (Degrees)	Total Flux / Luminous Intensity Φ_V (lm) / I_V (cd)
			x	y	Typ.	Typ.
Cool White	ASMT-TWBM-Nxx02	InGaN	0.34	0.34	110	2.5

Notes:

1. The dominant wavelength, λ_D , is derived from the CIE Chromaticity diagram and represents the color of the device.
2. $\theta_{1/2}$ is the off-axis angle where the luminous intensity is $1/2$ the peak intensity.

Table 4. Electrical Characteristics ($T_J = 25^\circ\text{C}$)

Part Number	Forward Voltage V_F (Volts) @ $I_F = 20\text{ mA}$			Thermal Resistance $R\theta_{JP}$ ($^\circ\text{C}/\text{W}$)
	Min.	Typ.	Max.	
ASMT-TWBM-Nxx02	2.8	3.2	3.6	230

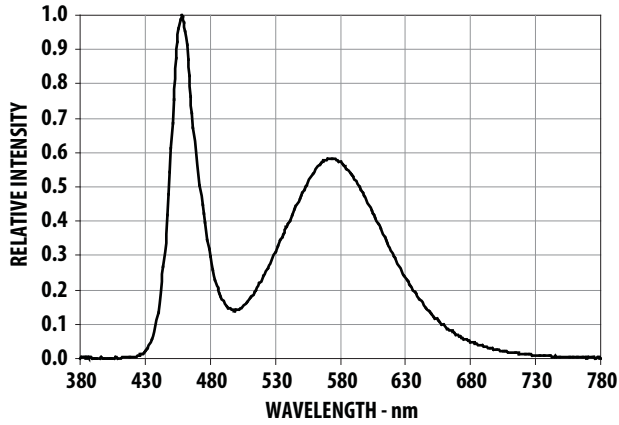

Figure 2. Relative Intensity Vs. Wavelength

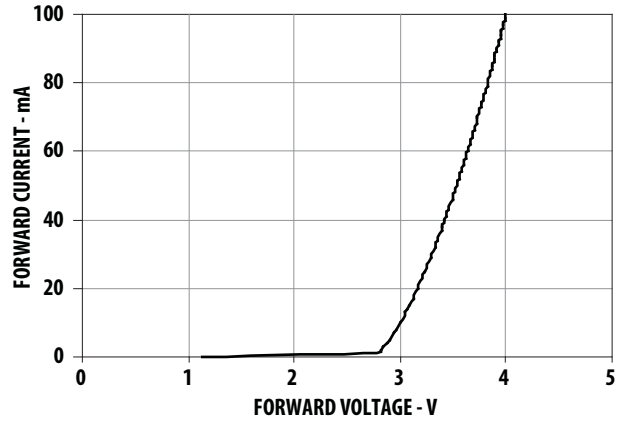

Figure 3. Forward Current Vs. Forward Voltage.

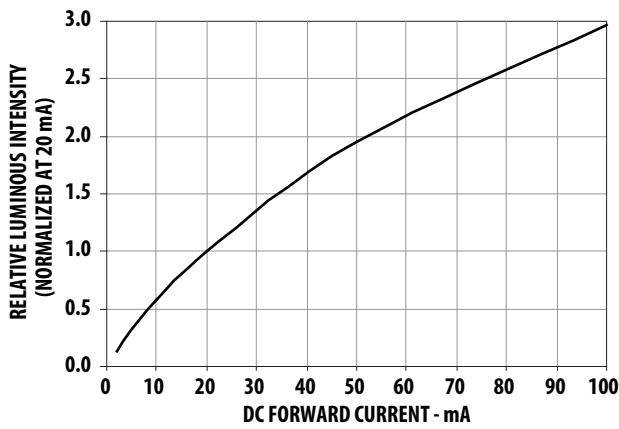

Figure 4. Relative Luminous Intensity Vs. Forward Current

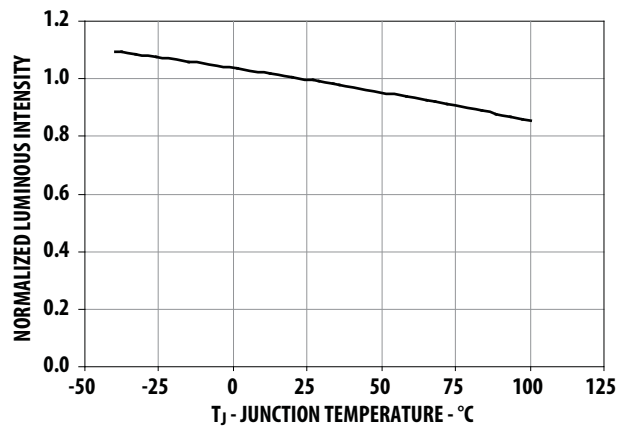

Figure 5. Relative Intensity Vs. Temperature

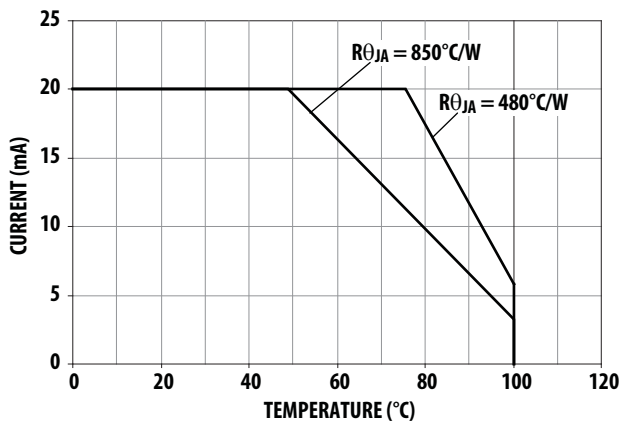

Figure 6. Maximum Forward Current Vs. Ambient Temperature. Derate Based on $T_{JMAX} = 110^{\circ}C$, $R\theta_{JA} = 850^{\circ}C/W$, $480^{\circ}C/W$.

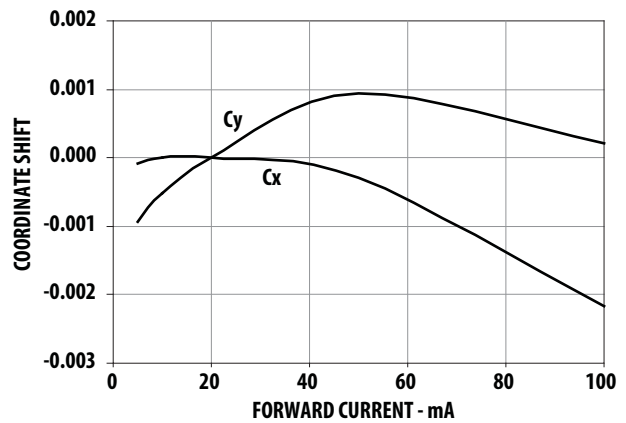

Figure 7. Chromaticity Shift Vs. forward current

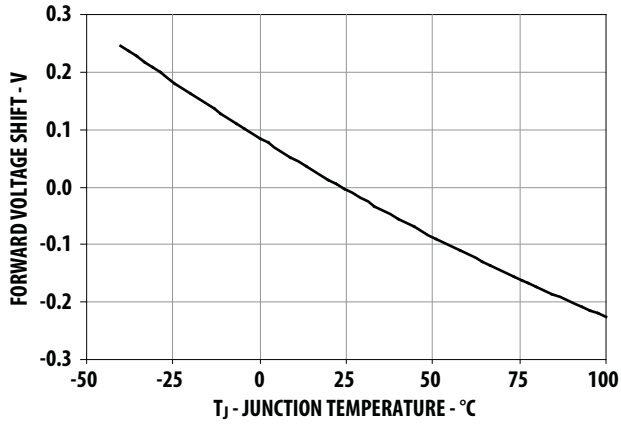

Figure 8. Forward Voltage Shift Vs. Temperature.

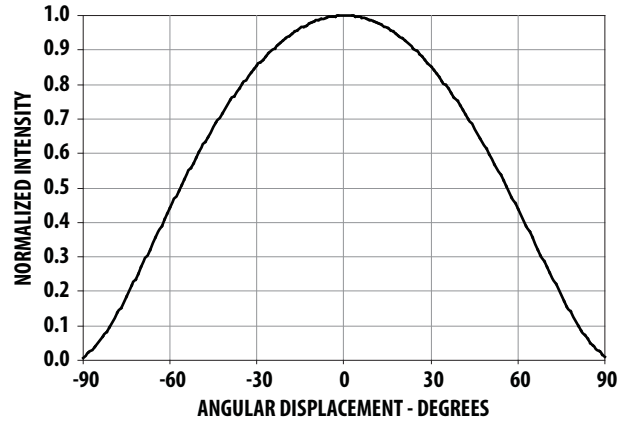

Figure 9. Radiation Pattern

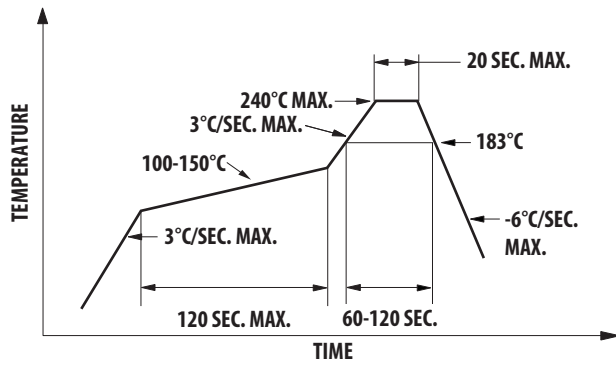
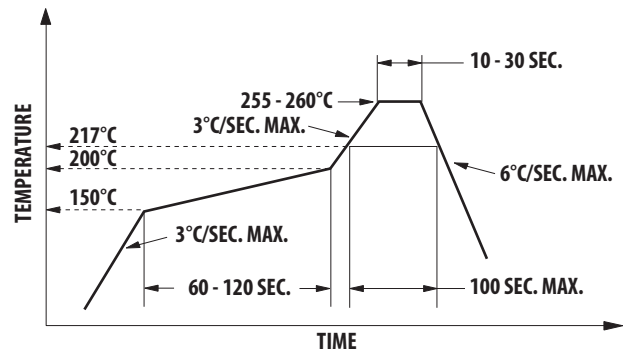

Figure 10a. Recommended SnPb Reflow Soldering Profile.



(Acc. to J-STD-020C)

Figure 10b. Recommended Pb-Free Reflow Soldering Profile.

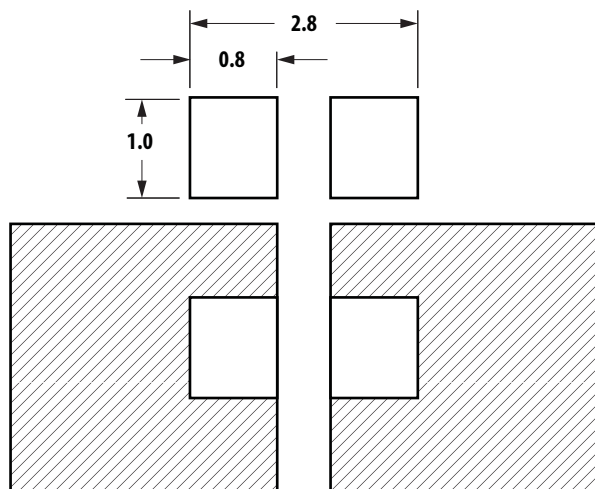

Figure 11. Recommended Soldering Pad Pattern.

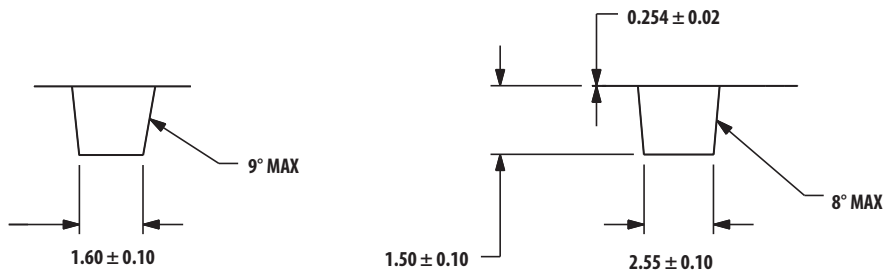
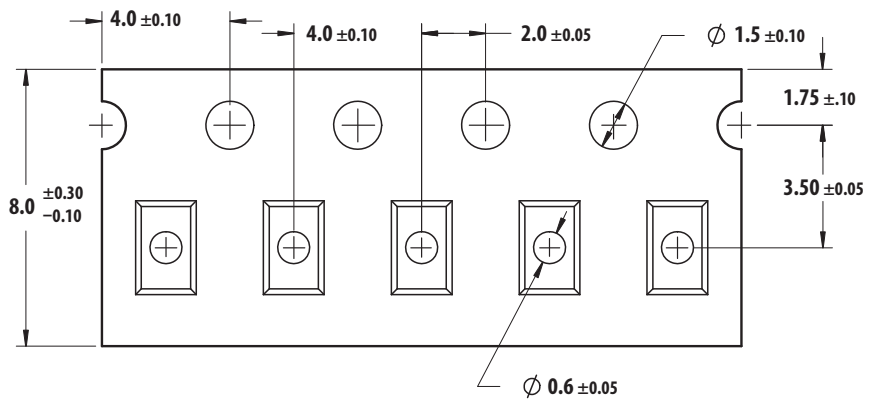

Figure 12. Tape Leader and Trailer Dimensions.

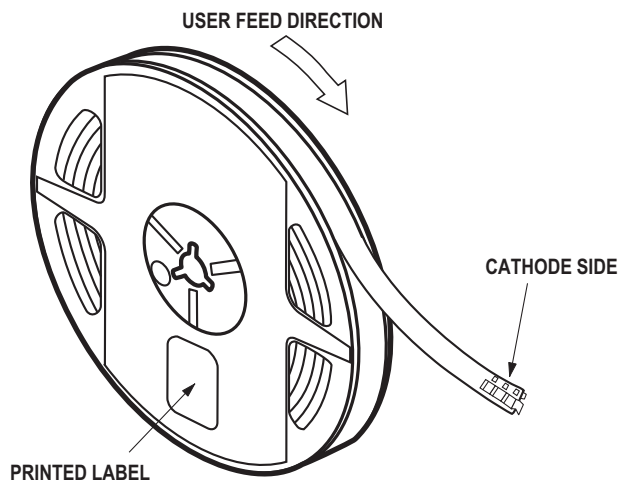

Figure 13. Reeling Orientation.

Handling Precaution

The encapsulation material of the product is made of silicone for better reliability of the product. As silicone is a soft material, please do not press on the silicone or poke a sharp object onto the silicone. These might damage the product and cause premature failure. During assembly or handling, the unit should be held on the body only. Please refer to Avago Application Note AN 5288 for detail information.

Moisture Sensitivity

This product is qualified as Moisture Sensitive Level 2 per Jedec J-STD-020. Precautions when handling this moisture sensitive product is important to ensure the reliability of the product. Do refer to Avago Application Note AN5305 Handling of Moisture Sensitive Surface Mount Devices for details.

A. Storage before use

- Unopen moisture barrier bag (MBB) can be stored at <math><40^{\circ}\text{C}/90\% \text{RH}</math> for 12 months. If the actual shelf life has exceeded 12 months and the HIC indicates that baking is not required, then it is safe to reflow the LEDs per the original MSL rating.
- It is not recommended to open the MBB prior to assembly (e.g. for IQC).

B. Control after opening the MBB

- The humidity indicator card (HIC) shall be read immediately upon opening of MBB.
- The LEDs must be kept at <math><30^{\circ}\text{C}/60\% \text{RH}</math> at all time and all high temperature related process including soldering, curing or rework need to be completed within 1 year.

C. Control for unfinished reel

- For any unused LEDs, they need to be stored in sealed MBB with desiccant or desiccator at <math><5\% \text{RH}</math> in order to stop the floor life. Otherwise, the floor life will continue and precaution should be taken to ensure it does not exceed 1 year.

D. Control of assembled boards

- If the PCB soldered with the LEDs is to be subjected to other high temperature processes, the PCB need to be stored in sealed MBB with desiccant or desiccator at <math><5\% \text{RH}</math> to ensure no LEDs have exceeded their floor life of 1 year.

E. Baking is required if:

- "60%" HIC indicator is NOT Green.
- The LEDs are exposed to condition of $>30^{\circ}\text{C}/60\% \text{RH}$ at any time.
- The LEDs floor life exceeded 1 year.

Recommended baking condition: $60\pm 5^{\circ}\text{C}$ for 20 hours.

Device Color (X₁)

W	White
---	-------

Intensity Bin Select (X₂X₃)

Individual reel will contain parts from one half bin only

X₂	Min IV Bin
X₃	
0	Full Distribution
2	2 half bins starting from X ₂ 1
3	3 half bins starting from X ₂ 1
4	4 half bins starting from X ₂ 1
5	5 half bins starting from X ₂ 1
6	2 half bins starting from X ₂ 2
7	3 half bins starting from X ₂ 2
8	4 half bins starting from X ₂ 2
9	5 half bins starting from X ₂ 2

Intensity Bin Limits

Bin ID	Min. (mcd)	Max. (mcd)
T1	285.00	355.00
T2	355.00	450.00
U1	450.00	560.00
U2	560.00	715.00
V1	715.00	900.00
V2	900.00	1125.00
W1	1125.00	1400.00
W2	1400.00	1800.00
X1	1800.00	2240.00
X2	2240.00	2850.00

Tolerance of each bin limit = ± 12%

Color Bin Select (X₄)

Individual reel will contain parts from one sub bin only.

X₄	
0	Full Distribution
A	5K and 5L only
B	6K and 6L only
C	7K and 7L only
D	8K and 8L only
E	5K and 6K only
F	5L and 6L only
G	6K and 7K only
H	6L and 7L only
J	7K and 8K only
K	7L and 8L only
L	5K, 5L, 6K and 6L only
M	6K, 6L, 7K and 7L only
N	7K, 7L, 8K and 8L only
Z	Special binning

Color Bin Limits

Bin ID	Sub Bin ID	Limits (Chromaticity Coordinates)				
5K	5Ka	x	0.296	0.304	0.302	0.294
		y	0.259	0.270	0.276	0.264
	5Kb	x	0.294	0.302	0.300	0.291
		y	0.264	0.276	0.281	0.268
	5Kc	x	0.304	0.313	0.312	0.302
		y	0.270	0.284	0.291	0.276
	5Kd	x	0.302	0.312	0.310	0.300
		y	0.276	0.291	0.297	0.281
5L	5La	x	0.291	0.300	0.298	0.288
		y	0.268	0.281	0.288	0.274
	5Lb	x	0.288	0.298	0.295	0.285
		y	0.274	0.288	0.294	0.279
	5Lc	x	0.300	0.310	0.309	0.298
		y	0.281	0.297	0.305	0.288
	5Ld	x	0.298	0.309	0.307	0.295
		y	0.288	0.305	0.312	0.294
6K	6Ka	x	0.313	0.322	0.321	0.312
		y	0.284	0.297	0.305	0.291
	6Kb	x	0.312	0.321	0.320	0.310
		y	0.291	0.305	0.314	0.297
	6Kc	x	0.322	0.330	0.330	0.321
		y	0.297	0.310	0.320	0.305
	6Kd	x	0.321	0.330	0.330	0.320
		y	0.305	0.320	0.330	0.314
6L	6La	x	0.310	0.320	0.319	0.309
		y	0.297	0.314	0.322	0.305
	6Lb	x	0.309	0.319	0.318	0.307
		y	0.305	0.322	0.329	0.312
	6Lc	x	0.320	0.330	0.330	0.319
		y	0.314	0.330	0.339	0.322
	6Ld	x	0.319	0.330	0.330	0.318
		y	0.322	0.339	0.347	0.329

Bin ID	Sub Bin ID	Limits (Chromaticity Coordinates)				
7K	7Ka	x	0.330	0.336	0.337	0.330
		y	0.310	0.320	0.330	0.320
	7Kb	x	0.330	0.337	0.337	0.330
		y	0.320	0.330	0.341	0.330
	7Kc	x	0.336	0.343	0.344	0.337
		y	0.320	0.331	0.341	0.330
	7Kd	x	0.337	0.344	0.345	0.337
		y	0.330	0.341	0.352	0.341
7L	7La	x	0.330	0.337	0.337	0.330
		y	0.330	0.341	0.349	0.339
	7Lb	x	0.330	0.337	0.338	0.330
		y	0.339	0.349	0.358	0.347
	7Lc	x	0.337	0.345	0.346	0.337
		y	0.341	0.352	0.362	0.349
	7Ld	x	0.337	0.346	0.347	0.338
		y	0.349	0.362	0.371	0.358
8K	8Ka	x	0.343	0.351	0.352	0.344
		y	0.331	0.343	0.354	0.341
	8Kb	x	0.344	0.352	0.354	0.345
		y	0.341	0.354	0.364	0.352
	8Kc	x	0.351	0.360	0.362	0.352
		y	0.343	0.357	0.369	0.354
	8Kd	x	0.352	0.362	0.364	0.354
		y	0.354	0.369	0.380	0.364
8L	8La	x	0.345	0.354	0.355	0.346
		y	0.352	0.364	0.375	0.362
	8Lb	x	0.346	0.355	0.356	0.347
		y	0.362	0.375	0.385	0.371
	8Lc	x	0.354	0.364	0.366	0.355
		y	0.364	0.380	0.391	0.375
	8Ld	x	0.355	0.366	0.367	0.356
		y	0.375	0.391	0.401	0.385

Tolerance of each bin limit = ± 0.02 .

Color Coordinates Chart

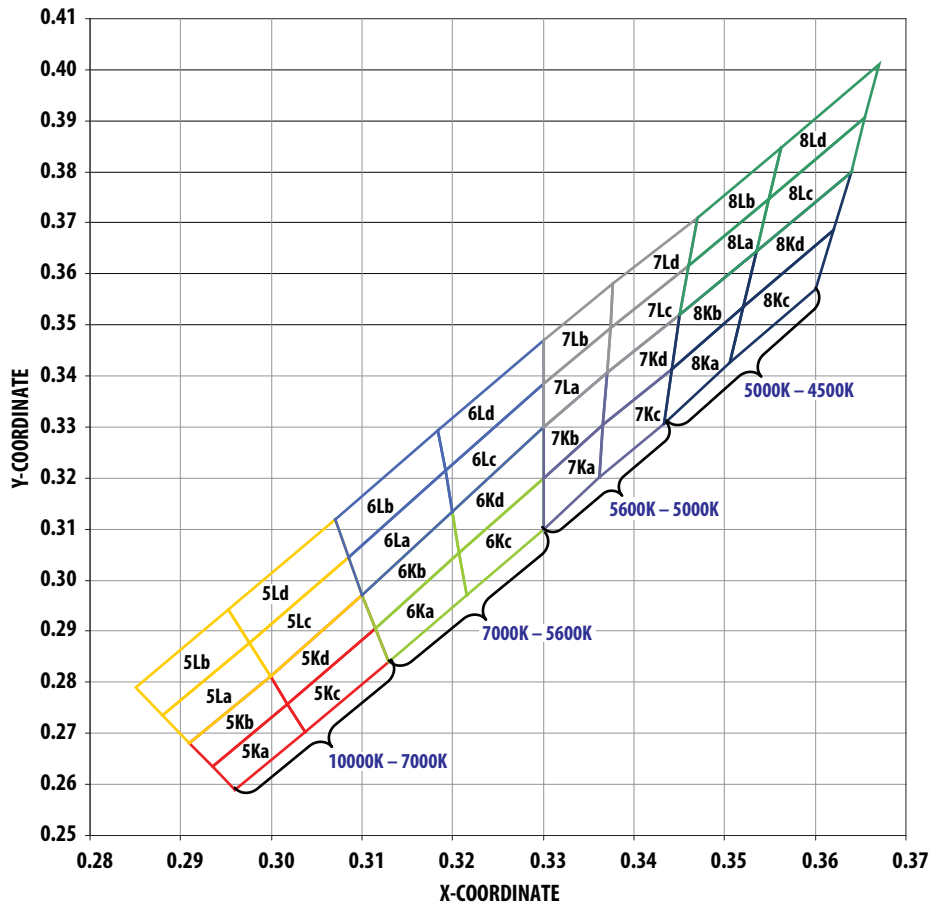

Packaging Option (X₅)

Option	Test Current	Package Type	Reel Size
2	20 mA	Top Mount	7 Inch

For product information and a complete list of distributors, please go to our web site: www.avagotech.com

Avago, Avago Technologies, and the A logo are trademarks of Avago Technologies in the United States and other countries. Data subject to change. Copyright © 2005-2010 Avago Technologies. All rights reserved. AV02-2204EN - April 5, 2010

AVAGO
TECHNOLOGIES