

Positive Voltage Regulators

GENERAL DESCRIPTION

The XC6201 series are highly precise, low power consumption, positive voltage regulators manufactured using CMOS and laser trimming technologies.

The series provides large currents with a significantly small dropout voltage.

The XC6201 consists of a current limiter circuit, a driver transistor, a precision reference voltage and an error amplifier. Output voltage is selectable in 0.1V steps between 1.3V ~ 6.0V.

SOT-25, SOT-89, USP-6B and TO-92 packages are available.

APPLICATIONS

- Smart phones / Mobile phones
- Portable game consoles
- Digital still cameras / Camcorders
- Digital audio equipment
- Reference voltage sources
- Multi-function power supplies

FEATURES

- Maximum Output Current** : 250mA (TYP.)
- Dropout Voltage** : 0.16V @ 100mA
: 0.40V @ 200mA
- Maximum Operating Voltage** : 10V
- Output Voltage Range** : 1.3V ~ 6.0V (0.1V increments)
- Fixed Voltage Accuracy** : $\pm 1\%$ ($V_{OUT(T)} \geq 2.0V$)
: $\pm 2\%$
- Low Power Consumption** : 2.0 μA (TYP.)
- Operating Ambient Temperature** : -40 ~ 85
- Packages** : SOT-25,
SOT-89
TO-92
USP-6B
- Environmentally Friendly** : EU RoHS Compliant, Pb Free
- Tantalum or Ceramic Capacitor compatible**

TYPICAL APPLICATION CIRCUIT

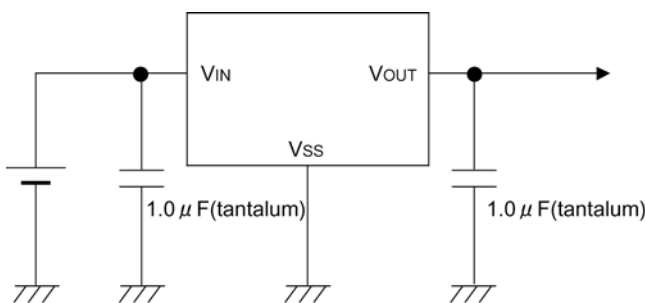

TYPICAL PERFORMANCE CHARACTERISTICS

Supply Current vs. Input Voltage

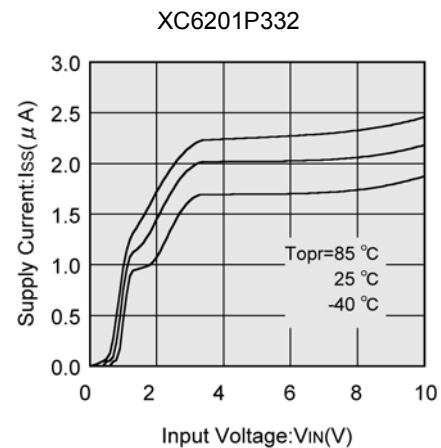

PIN CONFIGURATION

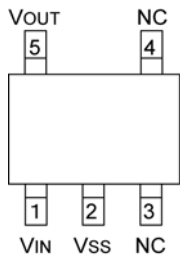

SOT-25
(TOP VIEW)

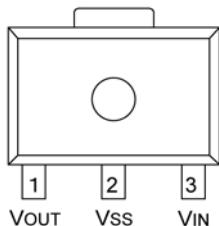

SOT-89
(TOP VIEW)

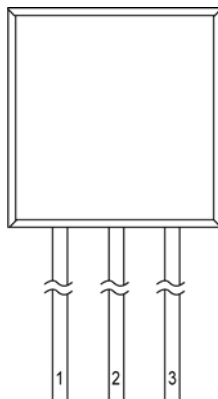

TO-92 (T Tvpde)
(SIDE VIEW)

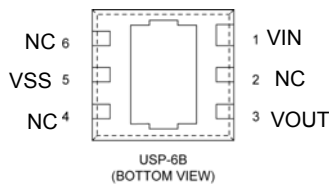

*The dissipation pad for the USP-6B package should be solder-plated in recommended mount pattern and metal masking so as to enhance mounting strength and heat release. If the pad needs to be connected to other pins, it should be connected to the VSS (No.5) pin.

PIN ASSIGNMENT

PIN NUMBER			PIN NAME	FUNCTION
SOT-25	SOT-89/TO-92 (T)	USP-6B		
5	1	3	VOUT	Output
2	2	5	VSS	Ground
1	3	1	VIN	Power Input
3, 4	-	2,4,6	NC	No Connection

PRODUCT CLASSIFICATION

Ordering Information

XC6201P - (*)
 ↑ ↑

DESIGNATOR	ITEM	SYMBOL	DESCRIPTION
	Product Number	01	-
	Type of Regulator	P	3-pin regulator
	Output Voltage	13 ~ 60	e.g. 30:3.0V 50:5.0V
	Output Voltage Accuracy	1	± 1%
		2	± 2%
	Packages (Order Unit)	MR	SOT-25 (3,000/Reel)
		MR-G	SOT-25 (3,000/Reel)
		PR	SOT-89 (1,000/Reel)
		PR-G	SOT-89 (1,000/Reel)
		TH	TO-92 Taping Type: Paper type (2,000/Tape)
		TH-G	TO-92 Taping Type: Paper type (2,000/Tape)
		TB	TO-92 Taping Type: Bag (500/Bag)
		TB-G	TO-92 Taping Type: Bag (500/Bag)
		DR	USP-6B (3,000/Reel)
		DR-G	USP-6B (3,000/Reel)

(*) The "-G" suffix denotes Halogen and Antimony free as well as being fully EU RoHS compliant.

* ±1% accuracy can be set at $V_{OUT(T)} \geq 2.0V$.

BLOCK DIAGRAM

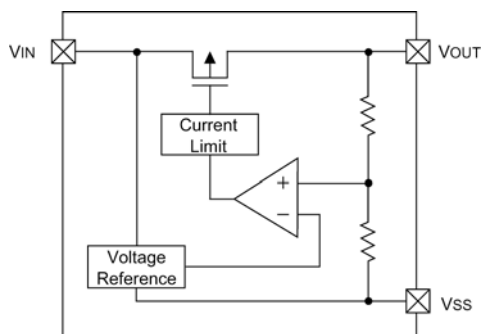

ABSOLUTE MAXIMUM RATINGS

Ta = 25

PARAMETER		SYMBOL	RATINGS	UNITS
Input Voltage		VIN	12.0	V
Output Current		IOUT	500	mA
Output Voltage		VOUT	VSS-0.3 ~ VIN+0.3	V
Power Dissipation	SOT-25	Pd	250	mW
	SOT-89		500	
	TO-92		300	
	USP-6B		120	
Operating Temperature		Topr	-40 ~ +85	
Storage Temperature		Tstg	-55 ~ +125	

ELECTRICAL CHARACTERISTICS

XC6201P132 VOUT(T)=1.3V^(*1)

Ta=25

PARAMETER	SYMBOL	CONDITIONS	MIN.	TYP.	MAX.	UNITS	CIRCUIT
Output Voltage	VOUT(E) ^(*2)	VIN=2.3V IOUT=10mA	1.274	1.300	1.326	V	
Maximum Output Current	IOUTmax	VIN=2.3V VOUT(E) 1.17V	60	-	-	mA	
Load Regulation	VOUT	VIN=2.3V 1mA IOUT 30mA	-	10	30	mV	
Dropout Voltage ^(*3)	Vdif1	IOUT=30mA	-	200	600	mV	
	Vdif2	IOUT=60mA	-	500	810		
Supply Current	ISS	VIN=2.3V	-	2.0	5.0	μA	
Line Regulation	$\frac{V_{OUT}}{V_{IN}} \cdot V_{OUT}$	IOUT=10mA 2.3V VIN 10.0V	-	0.2	0.3	%/V	
Input Voltage	VIN		1.8	-	10	V	-
Output Voltage Temperature Characteristics	$\frac{V_{OUT}}{T_{opr}} \cdot V_{OUT}$	IOUT=40mA -40 Topr 85	-	± 100	-	ppm/	

ELECTRICAL CHARACTERISTICS (Continued)

XC6201P182 $V_{OUT(T)}=1.8V$ ^(*1) Ta=25

PARAMETER	SYMBOL	CONDITIONS	MIN.	TYP.	MAX.	UNITS	CIRCUIT
Output Voltage	$V_{OUT(E)}$ ^(*2)	$V_{IN}=2.8V$ $I_{OUT}=40mA$	1.764	1.800	1.836	V	
Maximum Output Current	I_{OUTmax}	$V_{IN}=2.8V$ $V_{OUT(E)} 1.62V$	80	-	-	mA	
Load Regulation	V_{OUT}	$V_{IN}=2.8V$ $1mA I_{OUT} 40mA$	-	10	30	mV	
Dropout Voltage ^(*3)	V_{dif1}	$I_{OUT}=40mA$	-	200	370	mV	
	V_{dif2}	$I_{OUT}=80mA$	-	450	710		
Supply Current	I_{SS}	$V_{IN}=2.8V$	-	2.0	5.0	μA	
Line Regulation	$\frac{V_{OUT}}{V_{IN} \cdot V_{OUT}}$	$I_{OUT}=40mA$ $2.8V V_{IN} 10.0V$	-	0.2	0.3	%/V	
Input Voltage	V_{IN}		1.8	-	10	V	-
Output Voltage Temperature Characteristics	$\frac{V_{OUT}}{Topr \cdot V_{OUT}}$	$I_{OUT}=40mA$ $-40 Topr 85$	-	± 100	-	ppm/	

XC6201P272 $V_{OUT(T)}=2.7V$ ^(*1) Ta=25

PARAMETER	SYMBOL	CONDITIONS	MIN.	TYP.	MAX.	UNITS	CIRCUIT
Output Voltage	$V_{OUT(E)}$ ^(*2)	$V_{IN}=3.7V$ $I_{OUT}=40mA$	2.646	2.700	2.754	V	
Maximum Output Current	I_{OUTmax}	$V_{IN}=3.7V$ $V_{OUT(E)} 2.43V$	100	-	-	mA	
Load Regulation	V_{OUT}	$V_{IN}=3.7V$ $1mA I_{OUT} 60mA$	-	15	40	mV	
Dropout Voltage ^(*3)	V_{dif1}	$I_{OUT}=60mA$	-	200	370	mV	
	V_{dif2}	$I_{OUT}=120mA$	-	450	710		
Supply Current	I_{SS}	$V_{IN}=3.7V$	-	2.0	5.0	μA	
Line Regulation	$\frac{V_{OUT}}{V_{IN} \cdot V_{OUT}}$	$I_{OUT}=40mA$ $3.7V V_{IN} 10.0V$	-	0.2	0.3	%/V	
Input Voltage	V_{IN}		1.8	-	10	V	-
Output Voltage Temperature Characteristics	$\frac{V_{OUT}}{Topr \cdot V_{OUT}}$	$I_{OUT}=40mA$ $-40 Topr 85$	-	± 100	-	ppm/	

ELECTRICAL CHARACTERISTICS (Continued)

XC6201P332

$V_{OUT(T)}=3.3V$ ^(*1)

Ta=25

PARAMETER	SYMBOL	CONDITIONS	MIN.	TYP.	MAX.	UNITS	CIRCUIT
Output Voltage	$V_{OUT(E)}$ ^(*2)	$V_{IN}=4.3V$ $I_{OUT}=40mA$	3.234	3.300	3.366	V	
Maximum Output Current	I_{OUTmax}	$V_{IN}=4.3V$ $V_{OUT(E)} 2.97V$	150	-	-	mA	
Load Regulation	V_{OUT}	$V_{IN}=4.3V$ $1mA I_{OUT} 80mA$	-	20	50	mV	
Dropout Voltage ^(*3)	Vdif1	$I_{OUT}=80mA$	-	200	360	mV	
	Vdif2	$I_{OUT}=160mA$	-	450	700		
Supply Current	I_{SS}	$V_{IN}=4.3V$	-	2.0	5.0	μA	
Line Regulation	$\frac{V_{OUT}}{V_{IN} \cdot V_{OUT}}$	$I_{OUT}=40mA$ $4.3V V_{IN} 10.0V$	-	0.2	0.3	%/V	
Input Voltage	V_{IN}		1.8	-	10	V	-
Output Voltage Temperature Characteristics	$\frac{V_{OUT}}{Topr \cdot V_{OUT}}$	$I_{OUT}=40mA$ $-40 Topr 85$	-	± 100	-	ppm/	

XC6201P502

$V_{OUT(T)}=5.0V$ ^(*1)

Ta=25

PARAMETER	SYMBOL	CONDITIONS	MIN.	TYP.	MAX.	UNITS	CIRCUIT
Output Voltage	$V_{OUT(E)}$ ^(*2)	$V_{IN}=6.0V$ $I_{OUT}=40mA$	4.900	5.000	5.100	V	
Maximum Output Current	I_{OUTmax}	$V_{IN}=6.0V$ $V_{OUT(E)} 4.57V$	200	-	-	mA	
Load Regulation	V_{OUT}	$V_{IN}=6.0V$ $1mA I_{OUT} 100mA$	-	30	70	mV	
Dropout Voltage ^(*3)	Vdif1	$I_{OUT}=100mA$	-	160	340	mV	
	Vdif2	$I_{OUT}=200mA$	-	400	600		
Supply Current	I_{SS}	$V_{IN}=6.0V$	-	2.0	6.0	μA	
Line Regulation	$\frac{V_{OUT}}{V_{IN} \cdot V_{OUT}}$	$I_{OUT}=40mA$ $6.0V V_{IN} 10.0V$	-	0.2	0.3	%/V	
Input Voltage	V_{IN}		1.8	-	10	V	-
Output Voltage Temperature Characteristics	$\frac{V_{OUT}}{Topr \cdot V_{OUT}}$	$I_{OUT}=40mA$ $-40 Topr 85$	-	± 100	-	ppm/	

NOTE:

*1: $V_{OUT(T)}$ = Nominal output voltage.

*2: $V_{OUT(E)}$ = Effective output voltage (i.e. the output voltage when " $V_{OUT(T)}+1.0V$ " is provided while maintaining a certain I_{OUT} value).

*3: $V_{dif} = (V_{IN1} - V_{OUT1})$

V_{IN1} : An Input Voltage when V_{OUT1} appears as the input voltage is gradually decreased.

V_{OUT1} : A voltage equal to 98% of the output voltage when a stabilized ($V_{OUT(T)} + 1.0V$) is input.

TYPICAL APPLICATION CIRCUIT

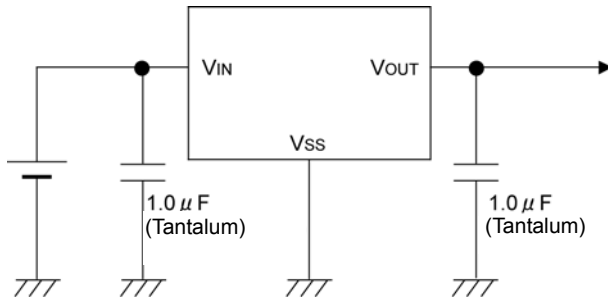

With the XC6201 series regulator, in order to ensure the stabilized output voltage, we suggest that an output capacitor (C_L) of $1 \mu F$ or more be connected between the output pin (V_{OUT}) and the V_{SS} pin. For using low ESR capacitor (e.g. ceramic capacitors), please make sure that the output voltage is more than 1.7V. When the output voltage is from 1.3V to 1.6V, the output capacitor should be a tantalum capacitor with a capacitance of $2.2 \mu F$. We also suggest an input capacitor (C_{IN}) should be connected between the V_{IN} and the V_{SS} in order to stabilize input power source.

OUTPUT VOLTAGE	C_{IN}	C_L (TANTALUM)	C_L (LOW ESR)
1.3V ~ 1.6V	$1.0 \mu F$	$2.2 \mu F$	-
1.7V ~ 6.0V	$1.0 \mu F$	$1.0 \mu F$	$1.0 \mu F$

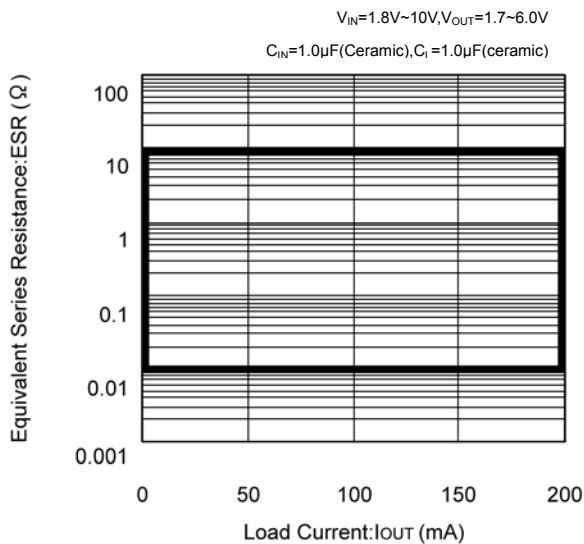

TEST CIRCUITS

Circuit : Supply Current

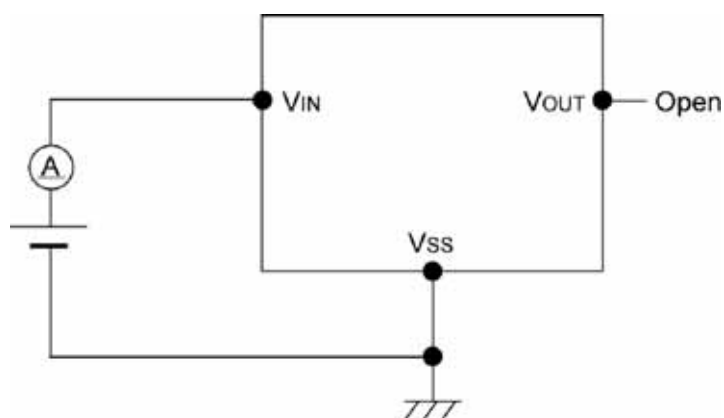

Circuit : Output Voltage, Oscillation, Line Regulation, Dropout Voltage, Load Regulation

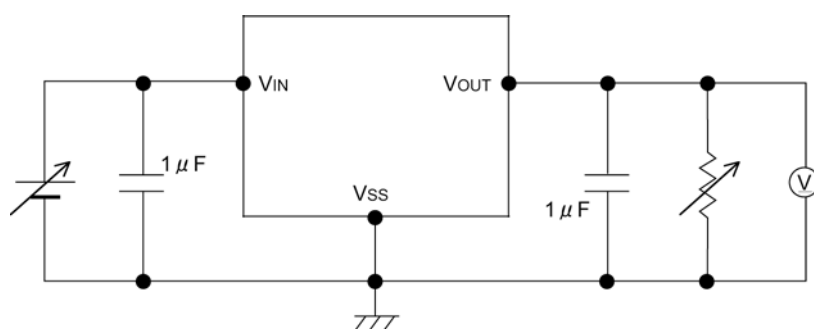

NOTE ON USE

1. Please use this IC within the stated absolute maximum ratings. The IC is liable to malfunction should the ratings be exceeded. When a voltage higher than the V_{IN} flows to the V_{OUT} like when using two power supplies, please connect a Schottky barrier diode between the V_{OUT} and the V_{IN} and do not exceed the V_{OUT} rating.
2. An oscillation may occur by the impedance between a power supply and the input of the IC. Where the impedance is 10 or more, please use an input capacitor (C_{IN}) of at least $1 \mu F$. In case of high output current, operation can be stabilized by increasing the input capacitor value. Also an oscillation may occur if the input capacitor value is smaller than the input impedance when the output capacitance (C_L) is large. In such cases, operations can be stabilized by either increasing the input capacitor value or reducing the output capacitor value.
3. Please ensure that output current (I_{OUT}) is less than $P_d / (V_{IN} - V_{OUT})$ and do not exceed the rated power dissipation value (P_d) of the package.

TYPICAL PERFORMANCE CHARACTERISTICS

(1) Output Voltage vs. Output Current

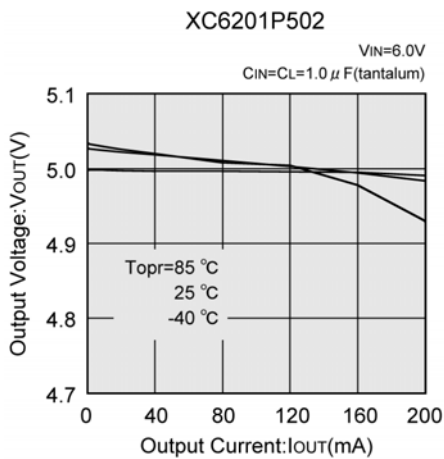
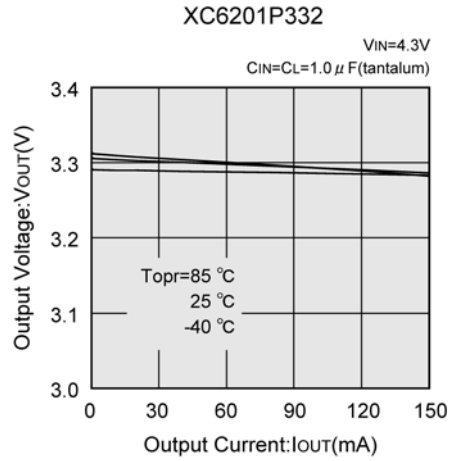
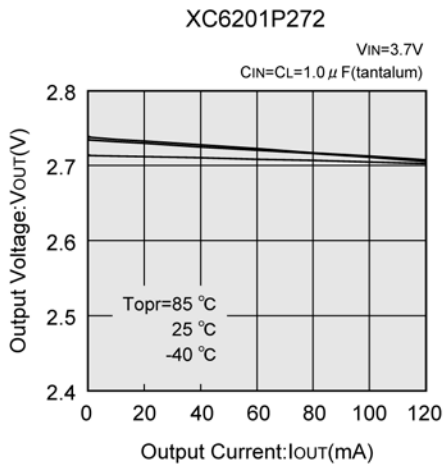
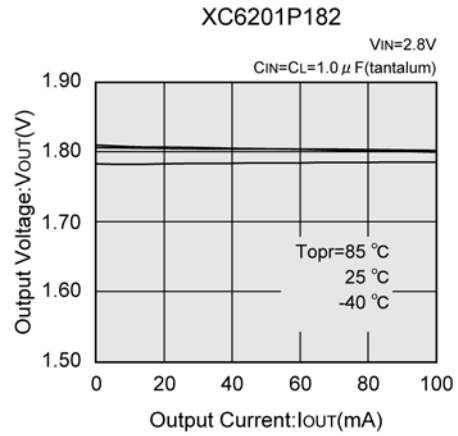
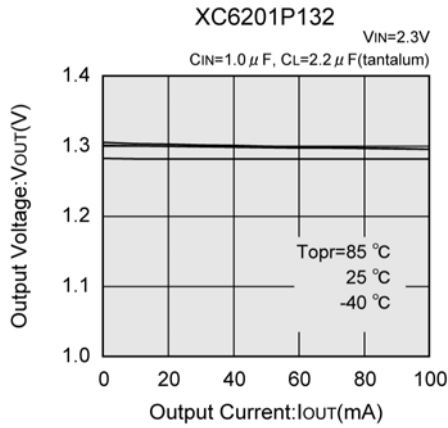

TYPICAL PERFORMANCE CHARACTERISTICS (Continued)

(2) Output Voltage vs. Input Voltage

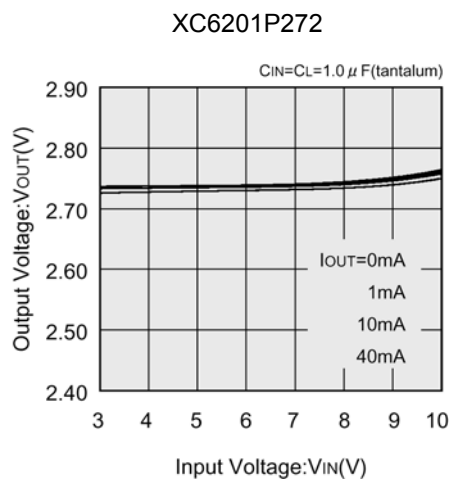
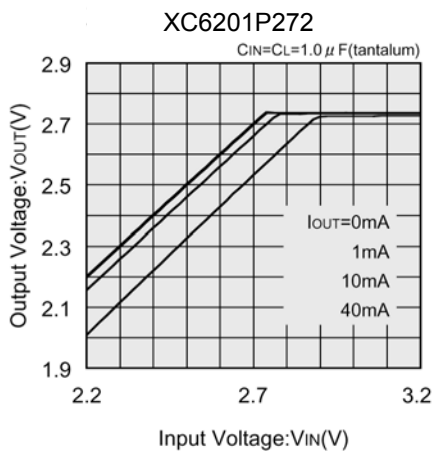
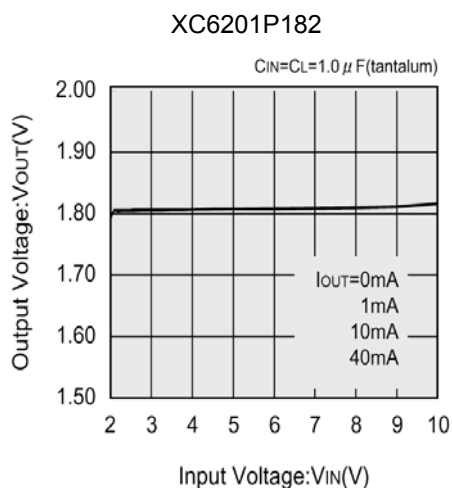
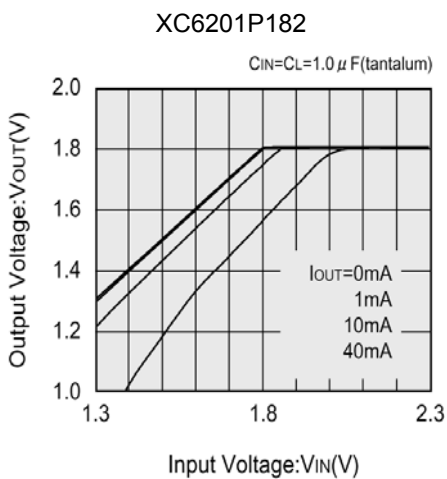
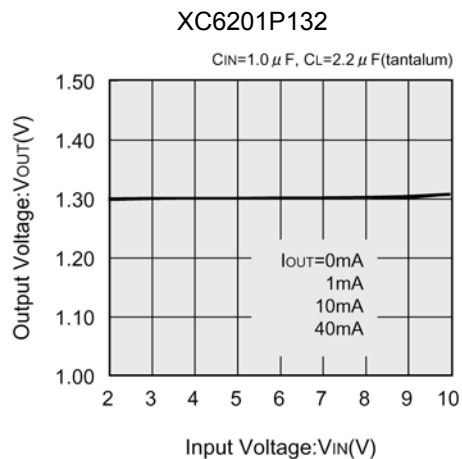
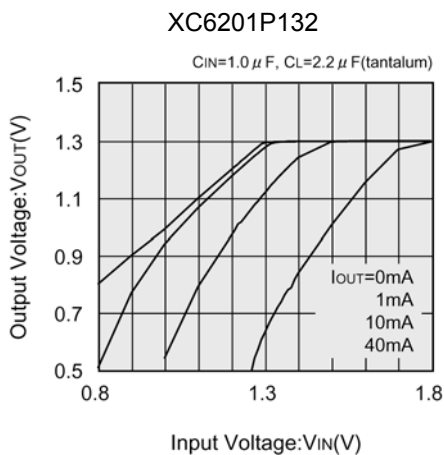

TYPICAL PERFORMANCE CHARACTERISTICS (Continued)

(2) Output Voltage vs. Input Voltage (Continued)

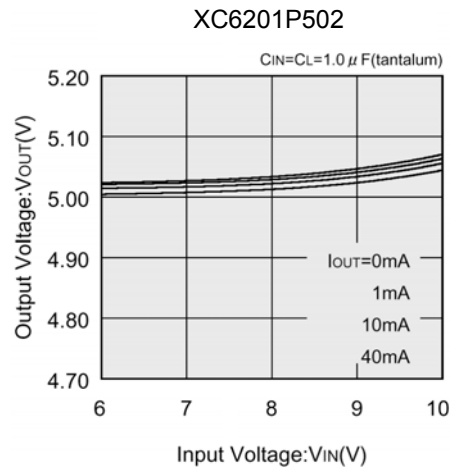
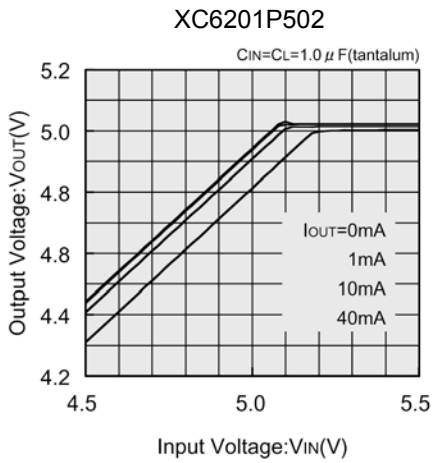
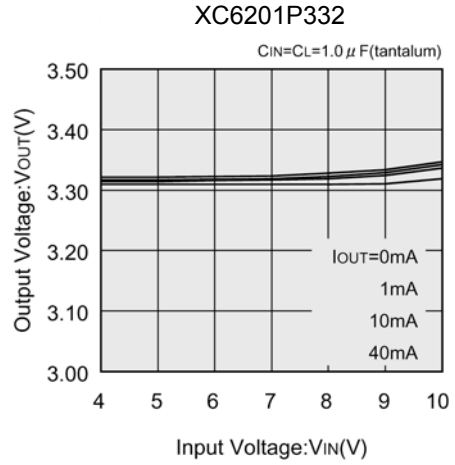
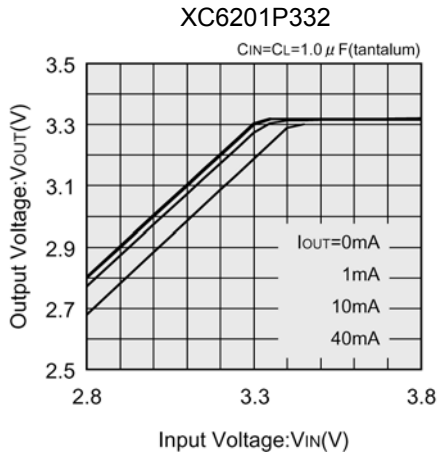

TYPICAL PERFORMANCE CHARACTERISTICS (Continued)

(3) Dropout Voltage vs. Output Current

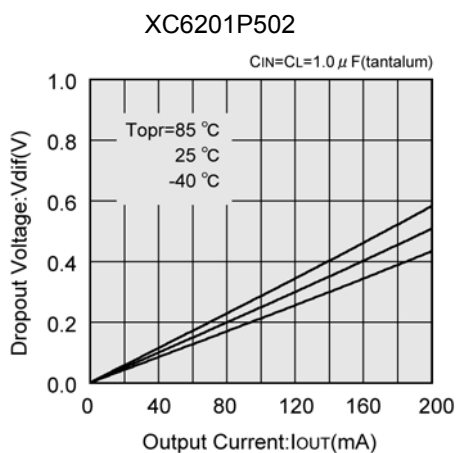
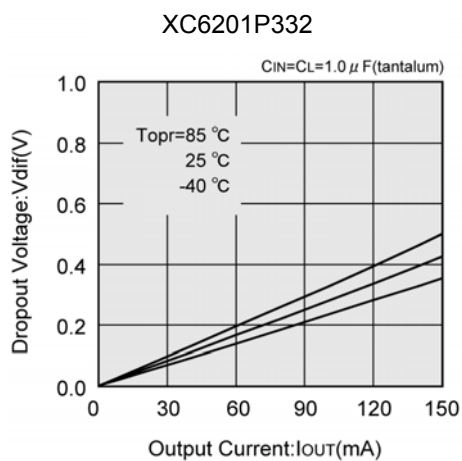
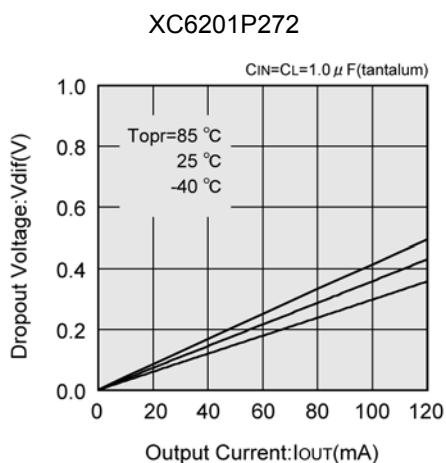
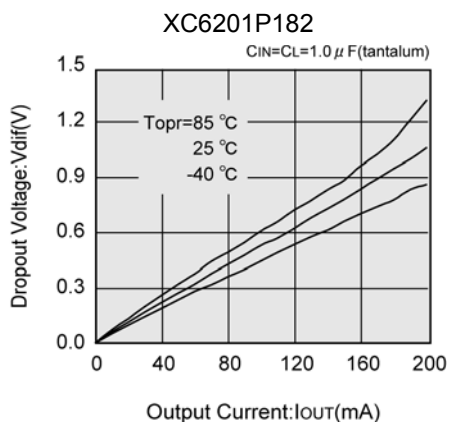
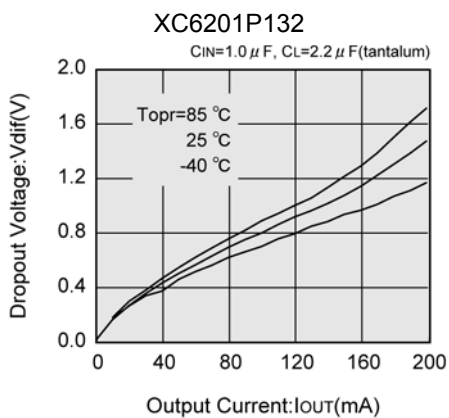

TYPICAL PERFORMANCE CHARACTERISTICS (Continued)

(4) Supply Current vs. Input Voltage

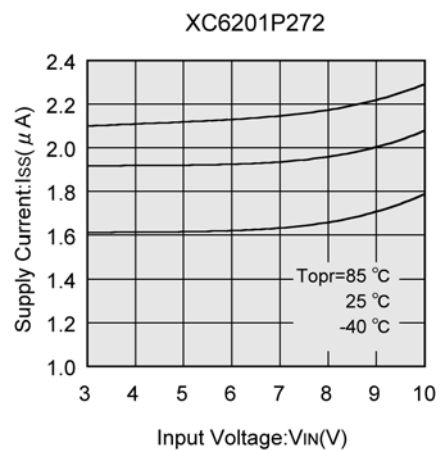
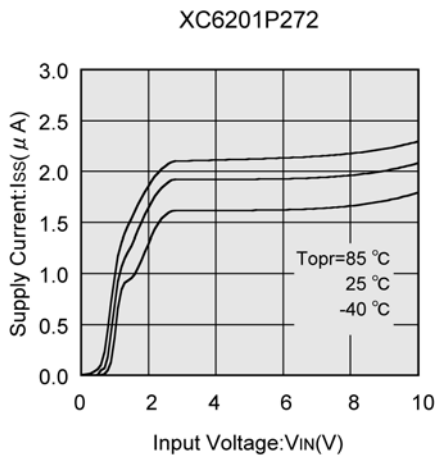
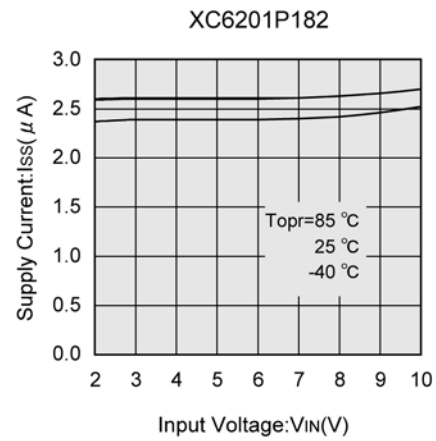
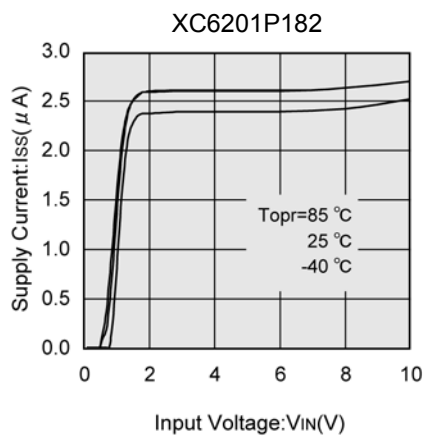
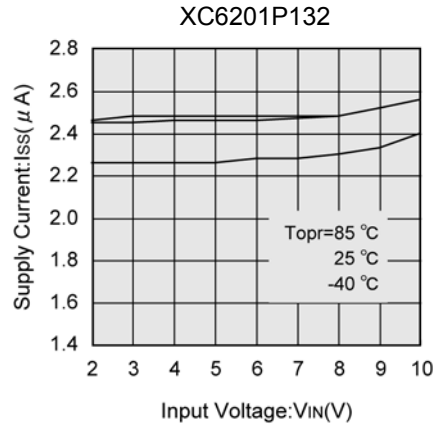
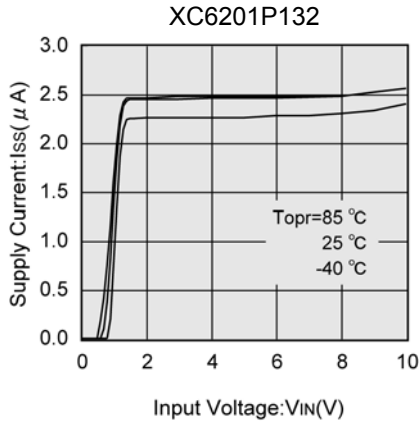

TYPICAL PERFORMANCE CHARACTERISTICS (Continued)

(4) Supply Current vs. Input Voltage (Continued)

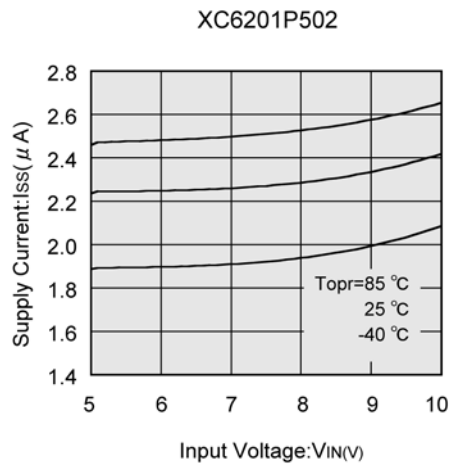
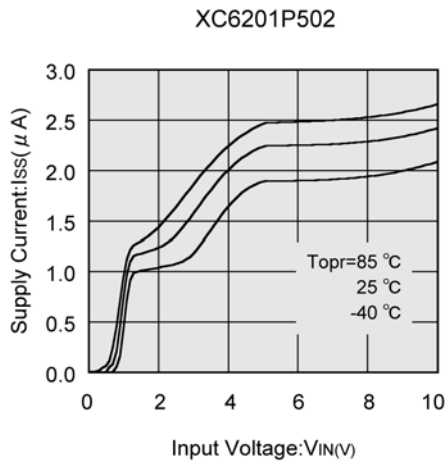
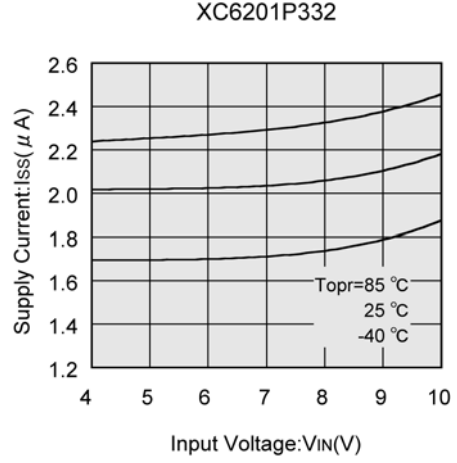
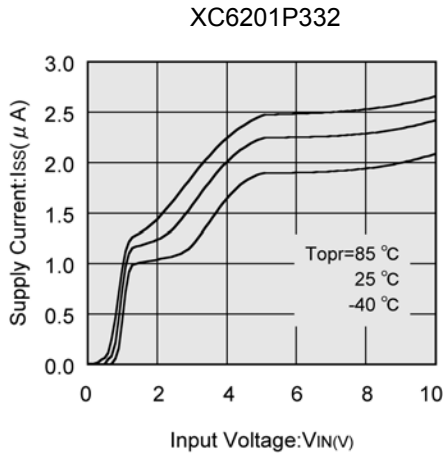

TYPICAL PERFORMANCE CHARACTERISTICS (Continued)

(5) Output Voltage vs. Ambient Temperature

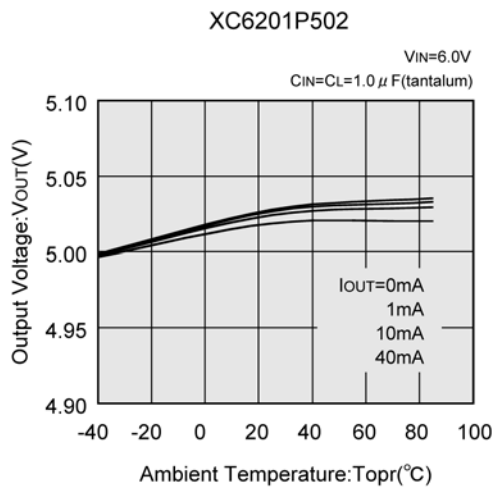
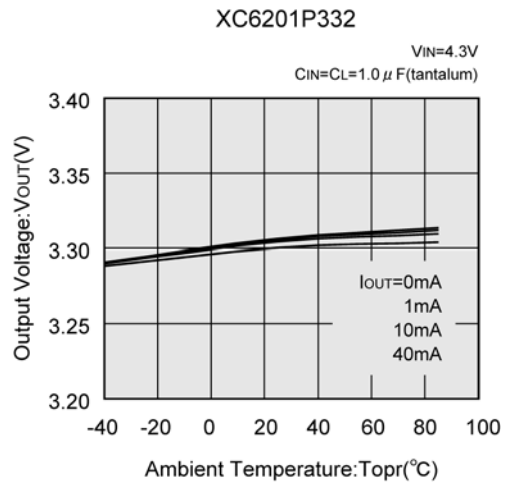
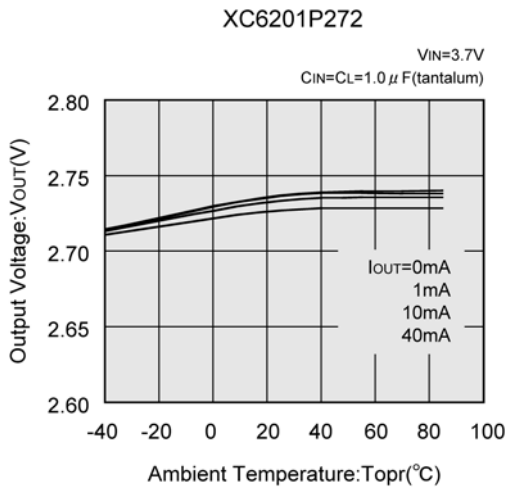
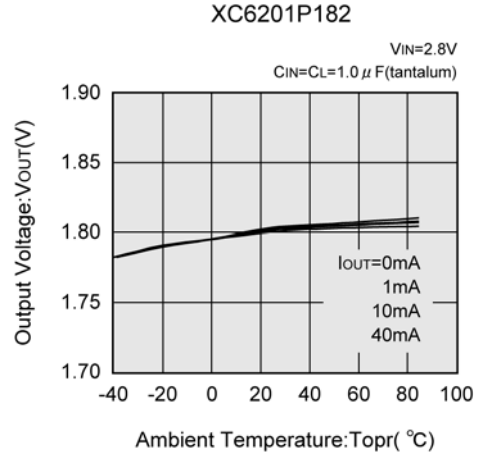
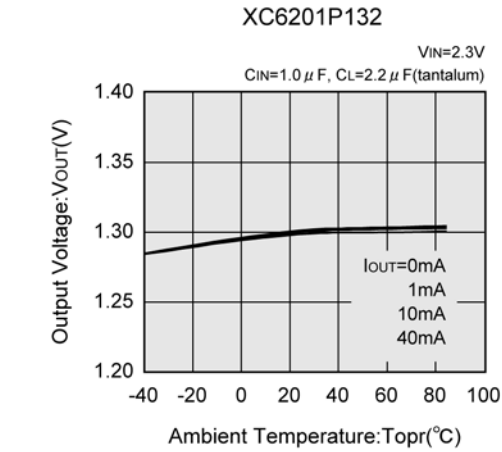

TYPICAL PERFORMANCE CHARACTERISTICS (Continued)

(6) Supply Current vs. Ambient Temperature

XC6201P132

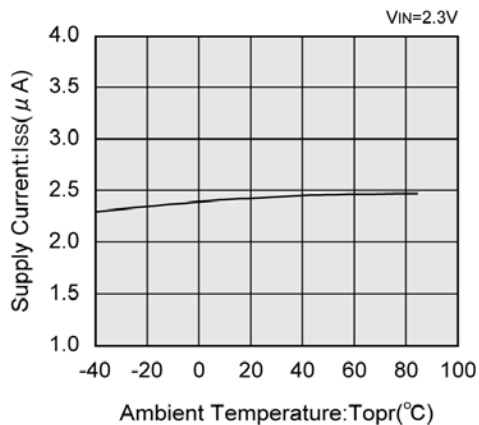

XC6201P182

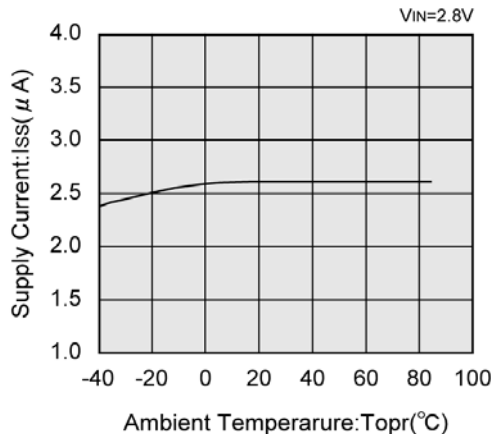

XC6201P272

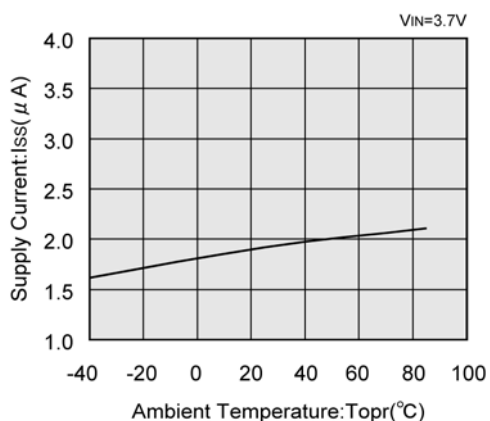

XC6201P332

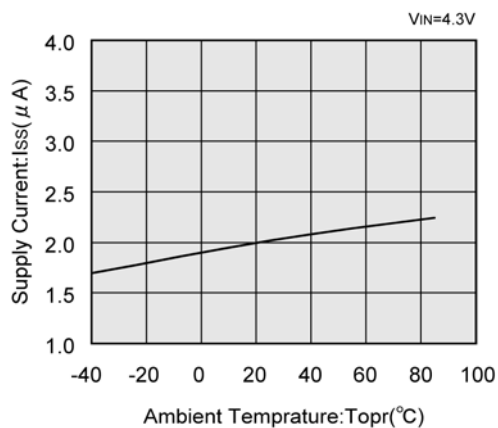

XC6201P502

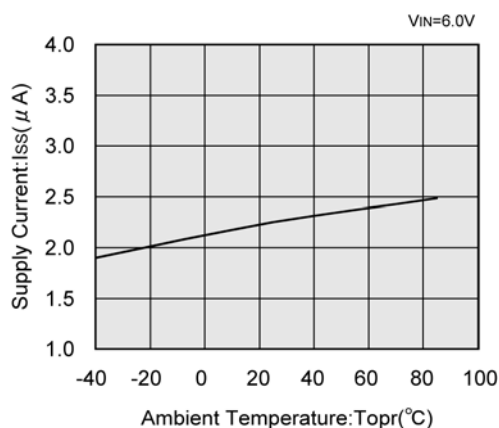

TYPICAL PERFORMANCE CHARACTERISTICS (Continued)

(7) Input Transient Response

XC6201P132

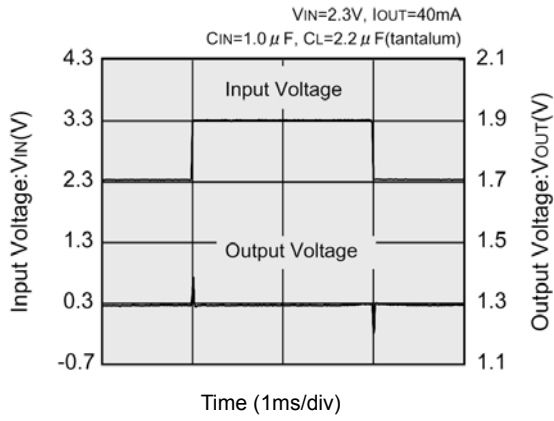

XC6201P182

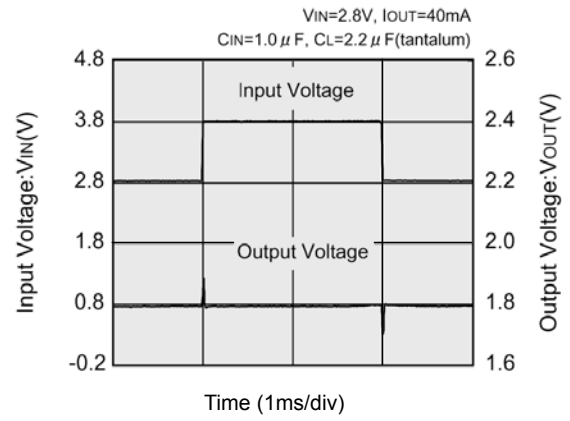

XC6201P272

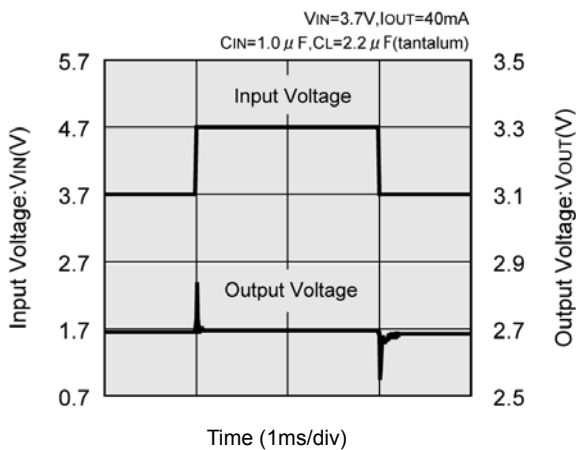

XC6201P332

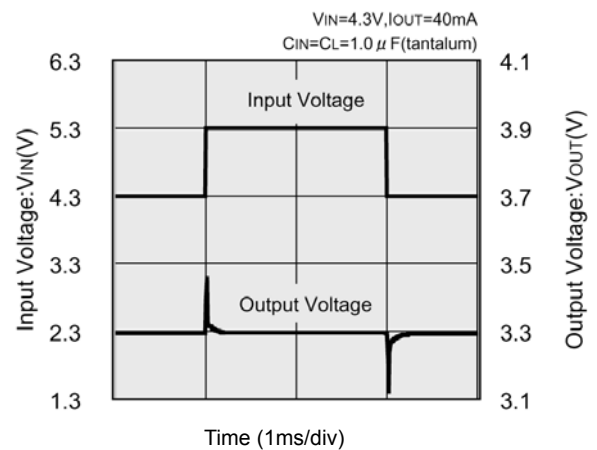

XC6201P502

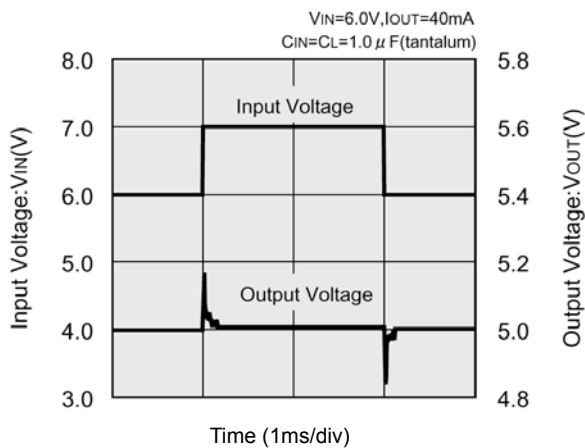

TYPICAL PERFORMANCE CHARACTERISTICS (Continued)

(8) Load Transient Response

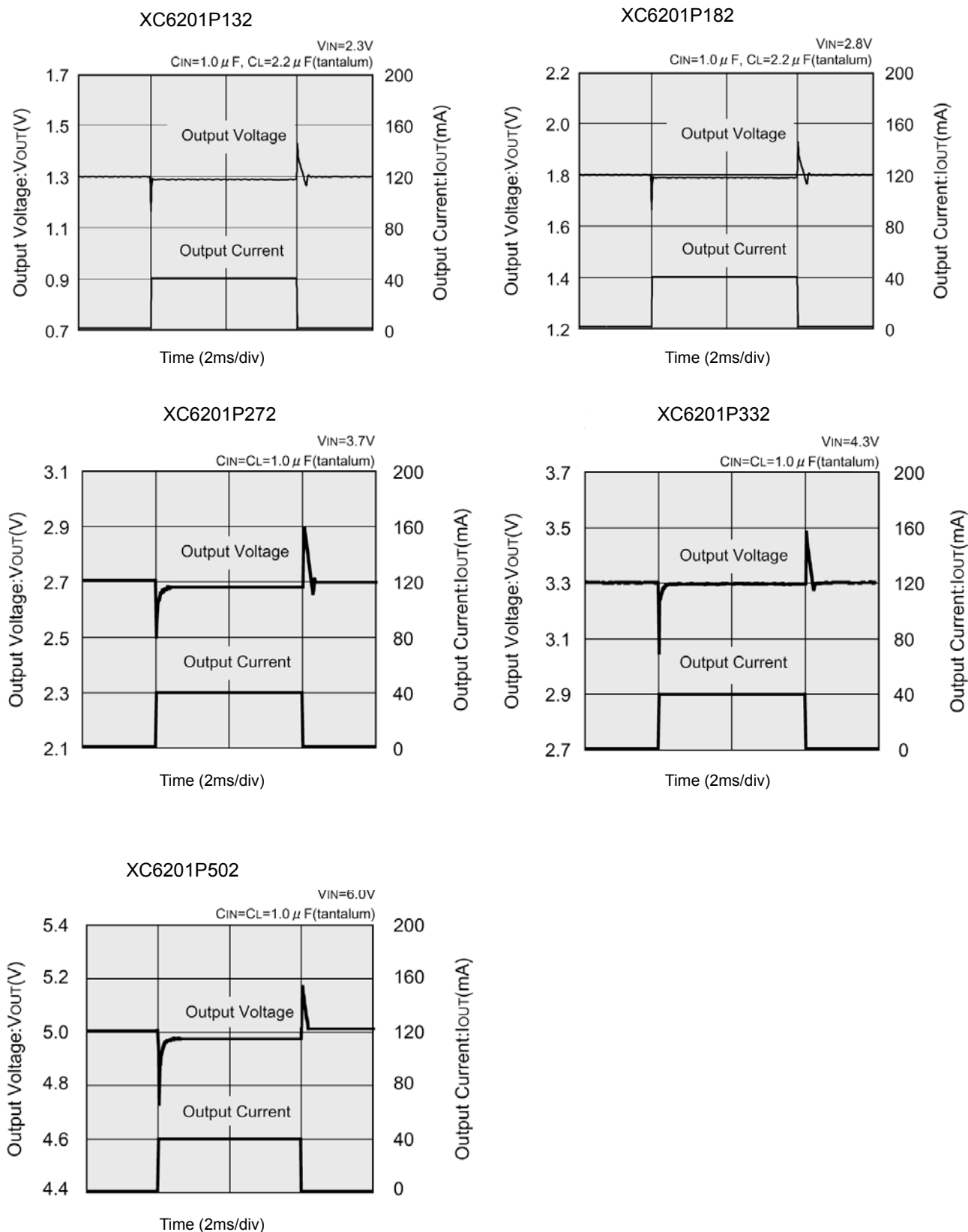

TYPICAL PERFORMANCE CHARACTERISTICS (Continued)

(9) Ripple Rejection Rate

XC6201P132

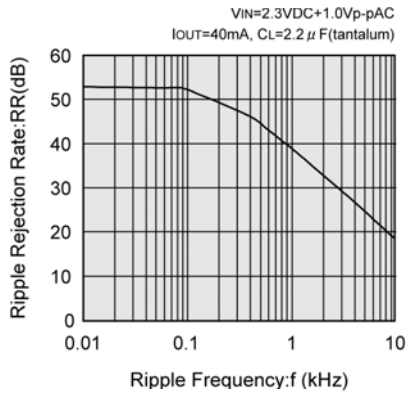

XC6201P182

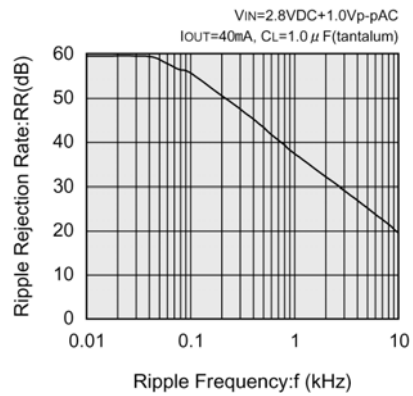

XC6201P272

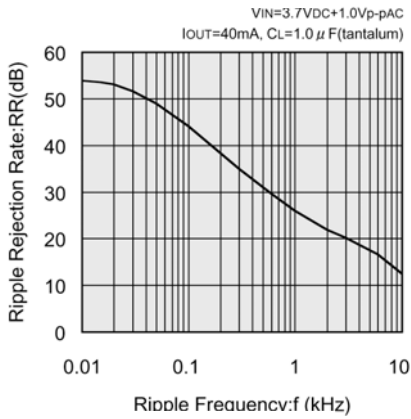

XC6201P332

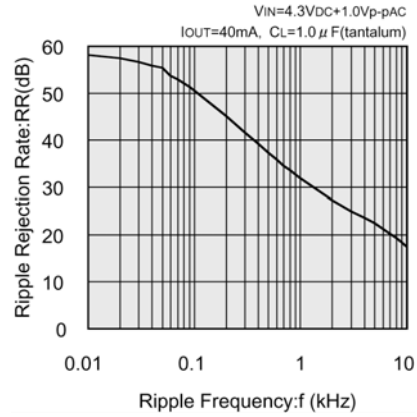

XC6201P502

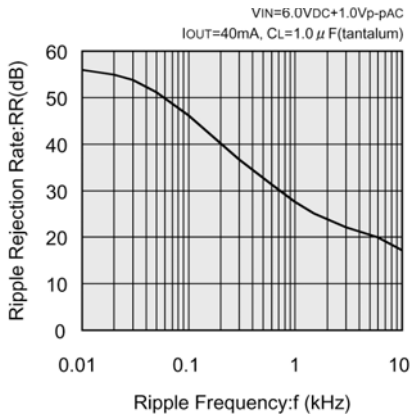

(10) Output Noise Density

XC6201P302

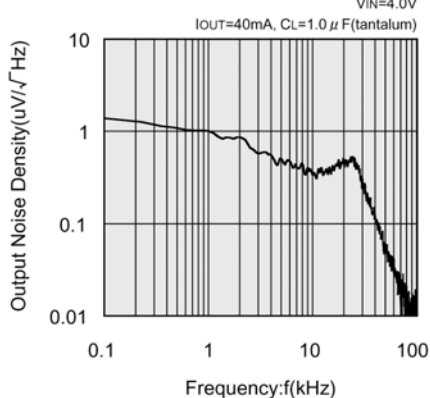

PACKAGING INFORMATION

SOT-25

Unit : mm

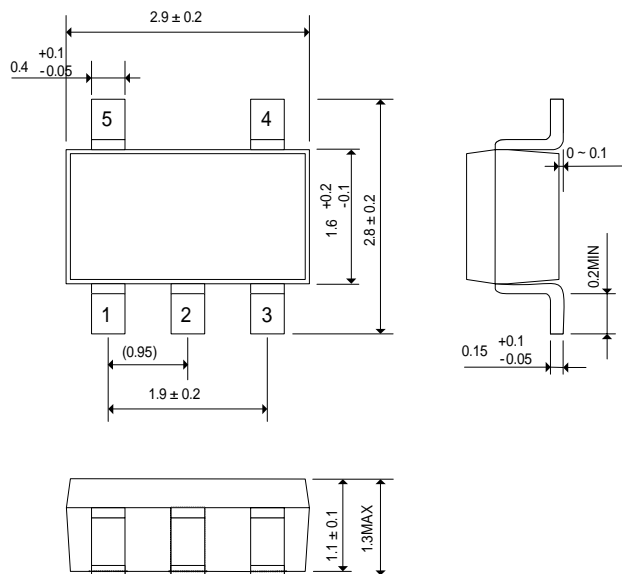

SOT-89

Unit : mm

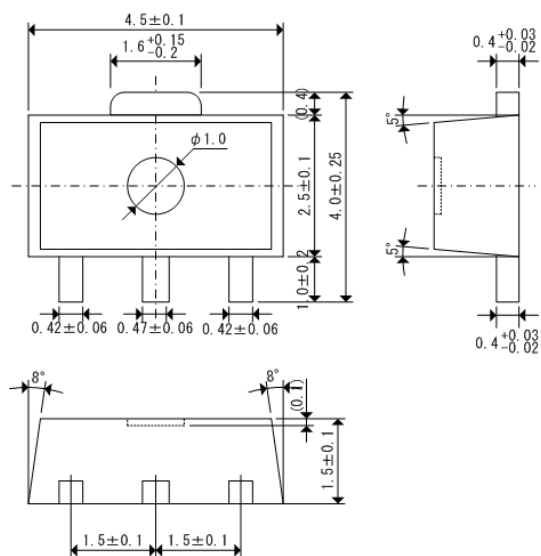

PACKAGING INFORMATION (Continued)

TO-92

Paper type

Unit : mm

Bag

Unit : mm

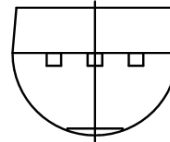
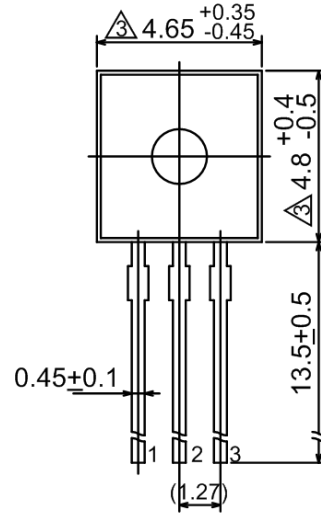
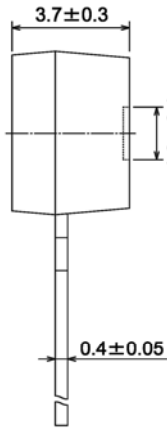
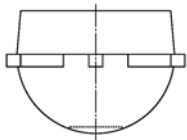
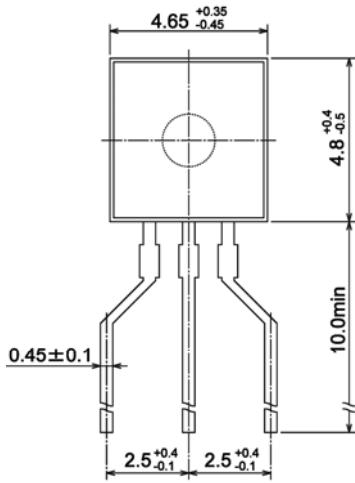

USP-6B

Unit : mm

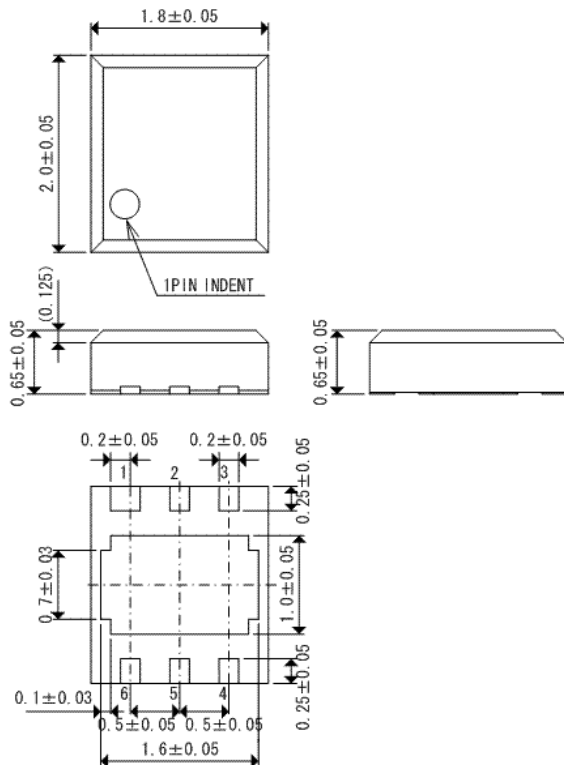

PACKAGING INFORMATION (Continued)

USP-6B Reference Pattern Layout

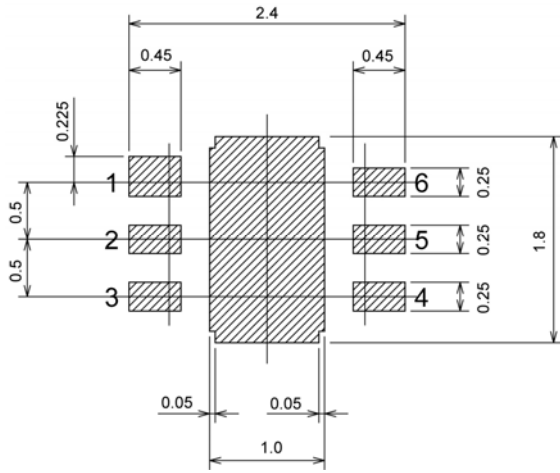

USP-6B Reference Metal Mask Design

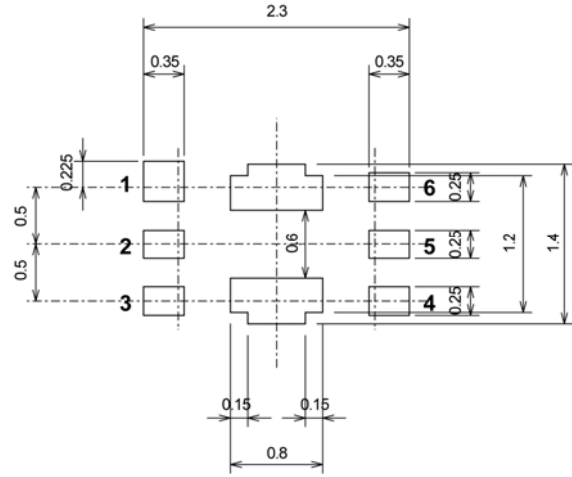

MARKING RULE

SOT-89, SOT-25

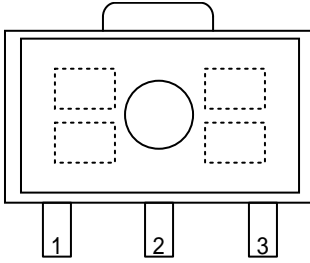

SOT-89
(TOP VIEW)

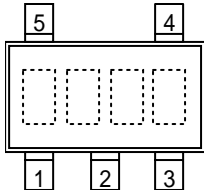

SOT-25
(TOP VIEW)

represents the product series

MARK	PRODUCT SERIES
1	XC6201xxxxxx

represents type of regulator

MARK		PRODUCT SERIES
Voltage= 0.1 ~ 3.0V	Voltage= 3.1 ~ 6.0V	
5	6	XC6201PXXXXX
8	9	XC6201TXXXXPX

represents output voltage

MARK	OUTPUT VOLTAGE (V)			MARK	OUTPUT VOLTAGE (V)		
0	-	3.1	-	F	1.6	4.6	-
1	-	3.2	-	H	1.7	4.7	-
2	-	3.3	-	K	1.8	4.8	-
3	-	3.4	-	L	1.9	4.9	-
4	-	3.5	-	M	2.0	5.0	-
5	-	3.6	-	N	2.1	5.1	-
6	-	3.7	-	P	2.2	5.2	-
7	-	3.8	-	R	2.3	5.3	-
8	-	3.9	-	S	2.4	5.4	-
9	-	4.0	-	T	2.5	5.5	-
A	-	4.1	-	U	2.6	5.6	-
B	-	4.2	-	V	2.7	5.7	-
C	1.3	4.3	-	X	2.8	5.8	-
D	1.4	4.4	-	Y	2.9	5.9	-
E	1.5	4.5	-	Z	3.0	6.0	-

represents assembly lot number

0 to 9, A to Z repeated (G, I, J, O, Q, W excluded)

MARKING RULE (Continued)

TO-92

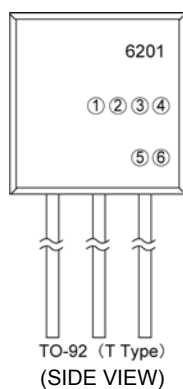

represents type of regulator

MARK	PRODUCT SERIES
P	XC6201Pxxxx
T	XC6201Txxxx

represents output voltage

MARK		VOLTAGE (V)	PRODUCT SERIES
3	3	3.3	XC6201Px33xx
5	0	5.0	XC6201Px50xx

represents detect voltage accuracy

MARK	DETECT VOLTAGE ACCURACY	PRODUCT SERIES
1	Within $\pm 1\%$	XC6201Pxx1xx
2	Within $\pm 2\%$	XC6201Pxx2xx

represents least significant digit of production year

MARK	PRODUCTION YEAR
3	2003
4	2004

represents the production lot number

0 to 9, A to Z repeated (G, I, J, O, Q, W excluded)

Note: No character inversion used.

USP-6B

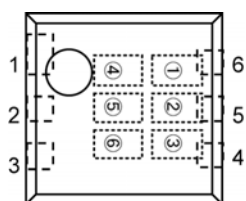

USP-6B
(TOP VIEW)

represents product series

MARK		PRODUCT SERIES
0	1	XC6201xxxxDx

represents type of regulator

MARK	TYPE	PRODUCT SERIES
P	3pin Regulator	XC6201PxxxDx
T	V _{IN} =7V(Rated)	XC6201TxxxDx

represents output voltage

MARK		VOLTAGE (V)	PRODUCT SERIES
3	3	3.3	XC6201x33xDx
5	0	5.0	XC6201x50xDx

represents assembly lot number

0 to 9, A to Z repeated (G, I, J, O, Q, W excluded)

Note: No character inversion used.

1. The products and product specifications contained herein are subject to change without notice to improve performance characteristics. Consult us, or our representatives before use, to confirm that the information in this datasheet is up to date.
2. We assume no responsibility for any infringement of patents, patent rights, or other rights arising from the use of any information and circuitry in this datasheet.
3. Please ensure suitable shipping controls (including fail-safe designs and aging protection) are in force for equipment employing products listed in this datasheet.
4. The products in this datasheet are not developed, designed, or approved for use with such equipment whose failure or malfunction can be reasonably expected to directly endanger the life of, or cause significant injury to, the user.
(e.g. Atomic energy; aerospace; transport; combustion and associated safety equipment thereof.)
5. Please use the products listed in this datasheet within the specified ranges.
Should you wish to use the products under conditions exceeding the specifications, please consult us or our representatives.
6. We assume no responsibility for damage or loss due to abnormal use.
7. All rights reserved. No part of this datasheet may be copied or reproduced without the prior permission of TOREX SEMICONDUCTOR LTD.

TOREX SEMICONDUCTOR LTD.