

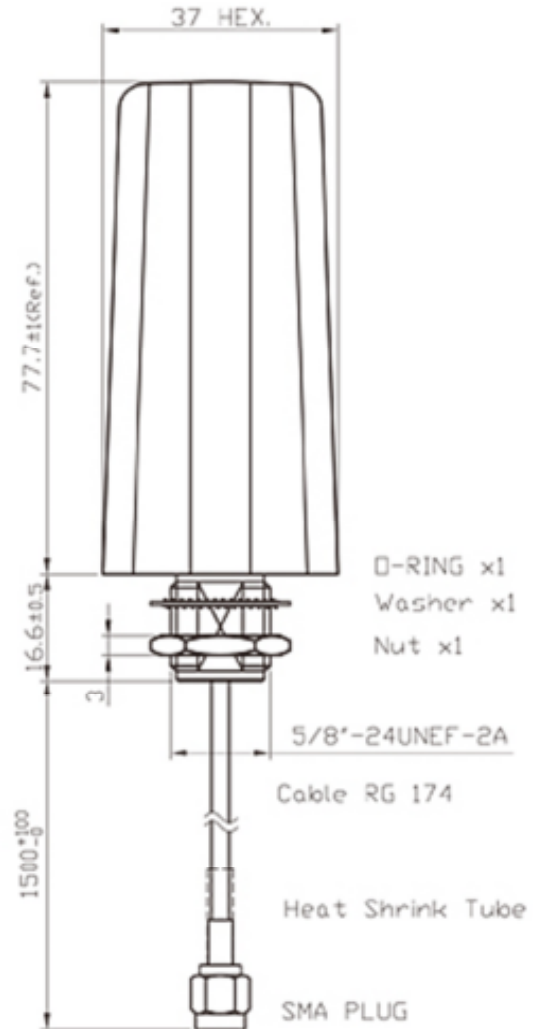

Key Specifications - Electrical

Operating temperature:	-20 to +65°C
Storage temperature:	-30 to +70°C
Impedance:	50 ohm
Gain:	1 / 3 / 5dBi
VSWR:	≤3.0
Frequency range:	698 - 960MHz 1710 - 2170MHz 2300 - 2700MHz
Radiation:	Omni-directional
Polarization:	Vertical
HBPW ± 3dB@EPlane:	120° @ 698-960MHz @ EPlane 50° @ 1710-2170MHz @ EPlane 30° @ 2300-2700MHz @ EPlane
HBPW ± 3dB@HPlane:	360° @ 698-960MHz @ HPlane 360° @ 1710-2170MHz @ HPlane 360° @ 2300-2700MHz @ HPlane



Key Specifications - Mechanical

Weight:	140g
Cable:	RG174
Connector:	SMA Plug
Waterproof:	IP65

Test Reports

Return Loss / VSWR

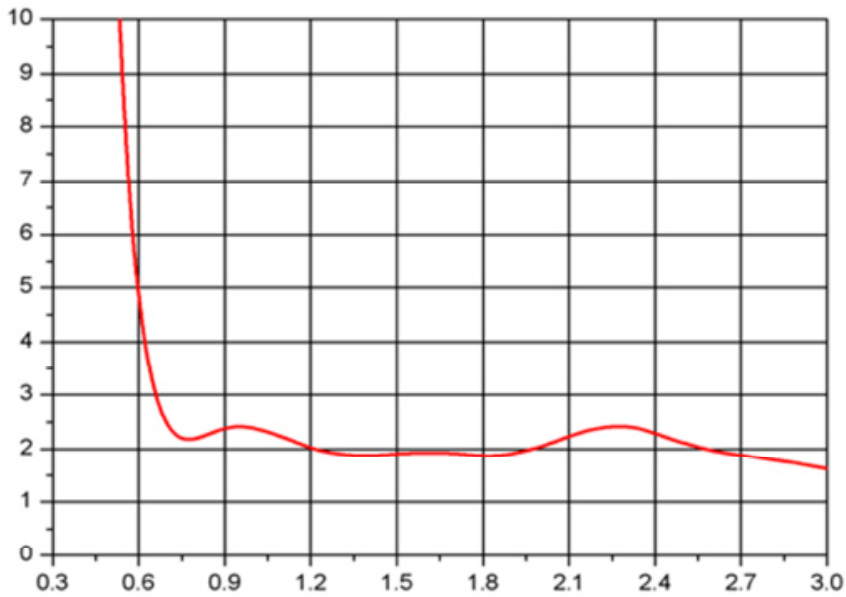

Pattern

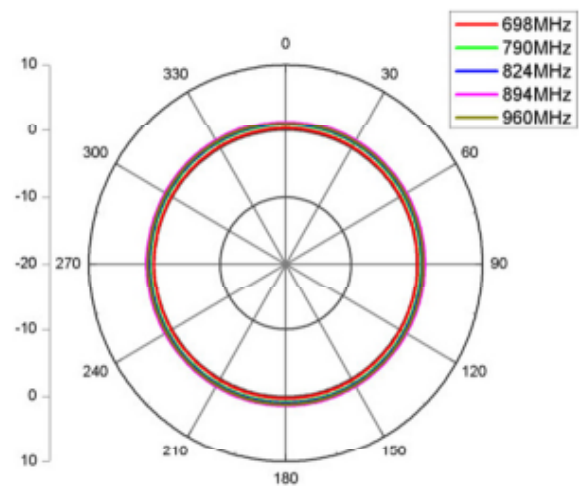
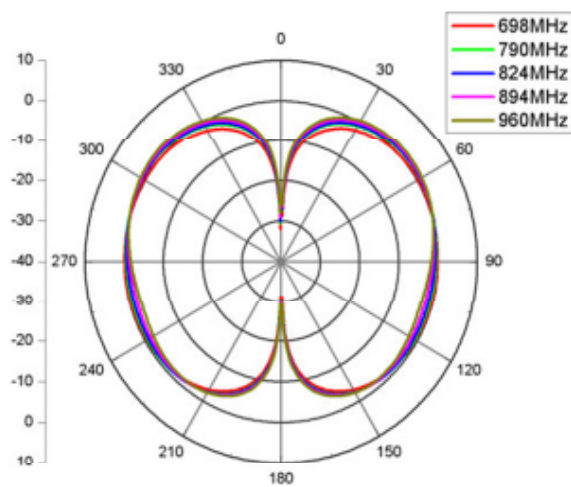

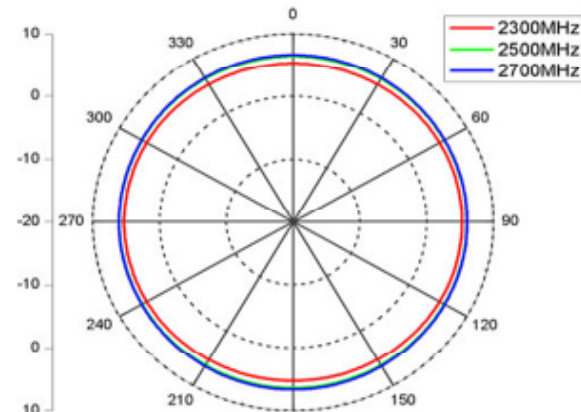
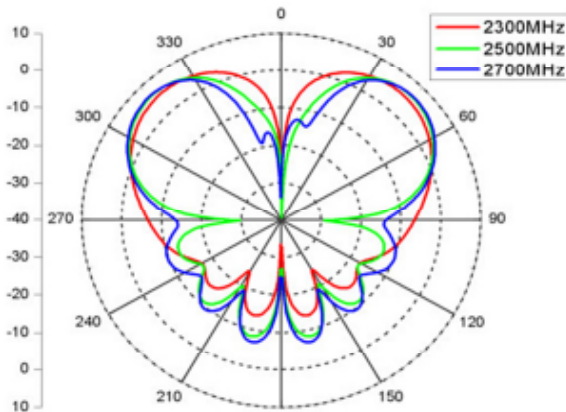
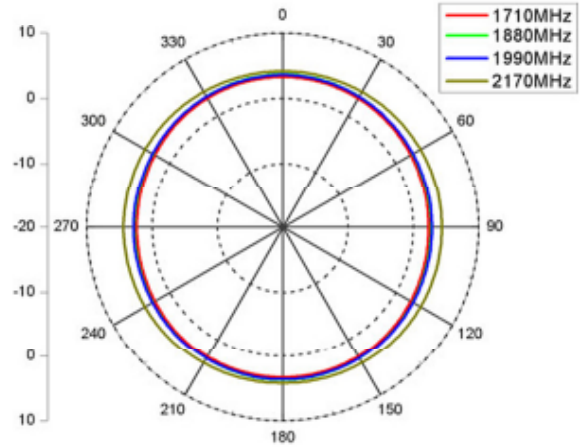
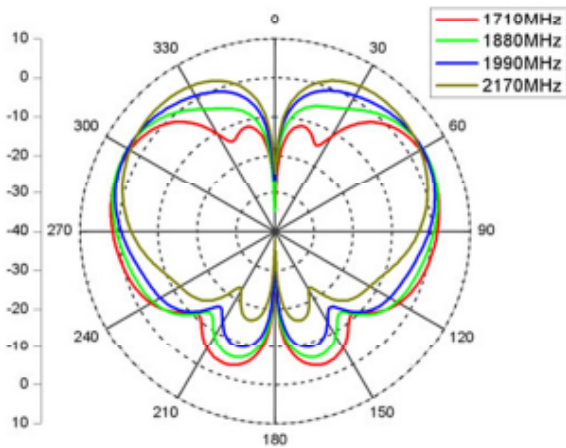

Return Loss - 2.5M cable

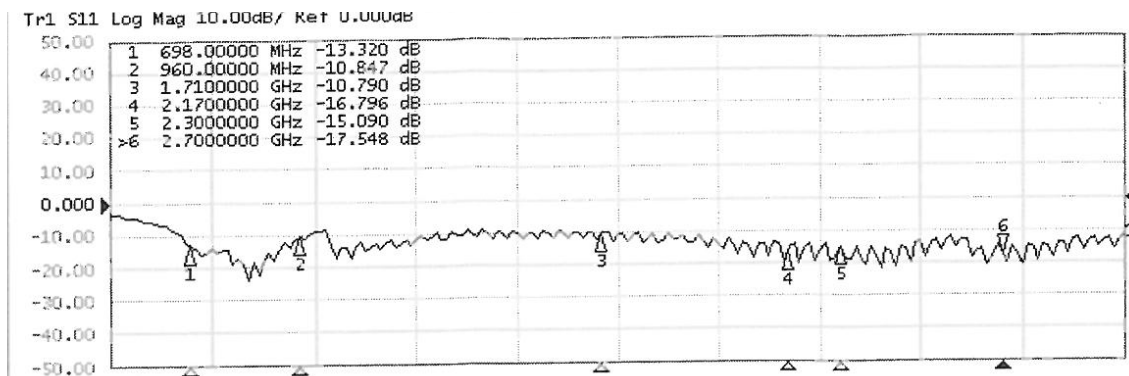

VSWR - 2.5M cable

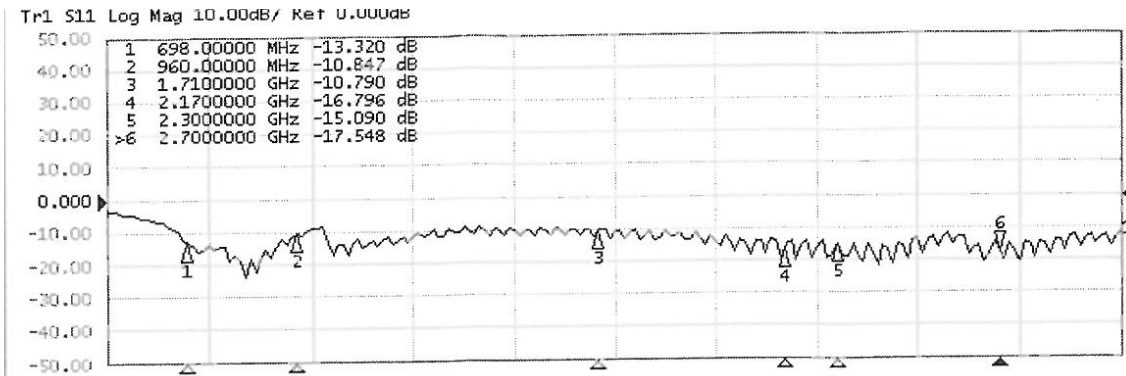

Return Loss - 5M cable

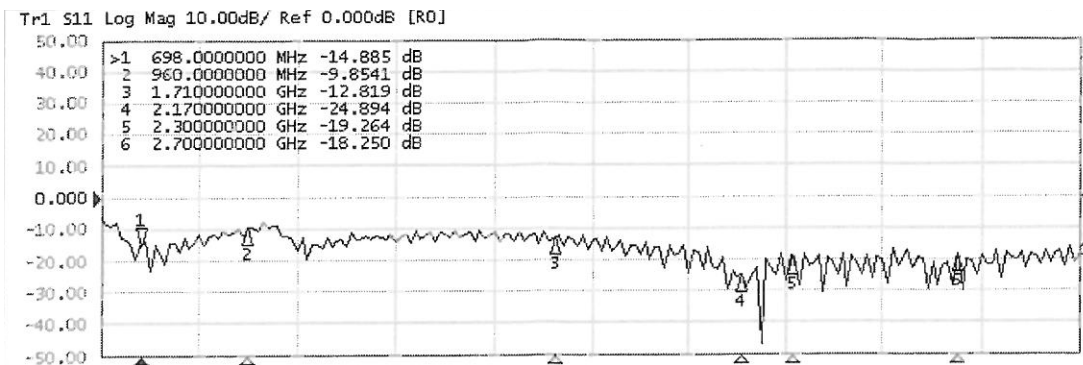

Return Loss - 5M cable

