

MP10005G-G Thru. MP1010G-G

Reverse Voltage: 50 to 1000V

Forward Current: 10.0A

RoHS Device

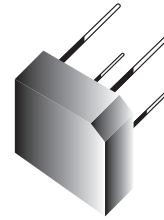

Features

- Low forward voltage drop.
- Small size ; simple installation.
- Sliver plated copper leads
- Surge overload rating - 200 amperes peak.
- Materials used carries U/L recognition.

Mechanical Data

- Polarit:As marked on Body
- Mounting position:Any
- Weight: 7.33 grams

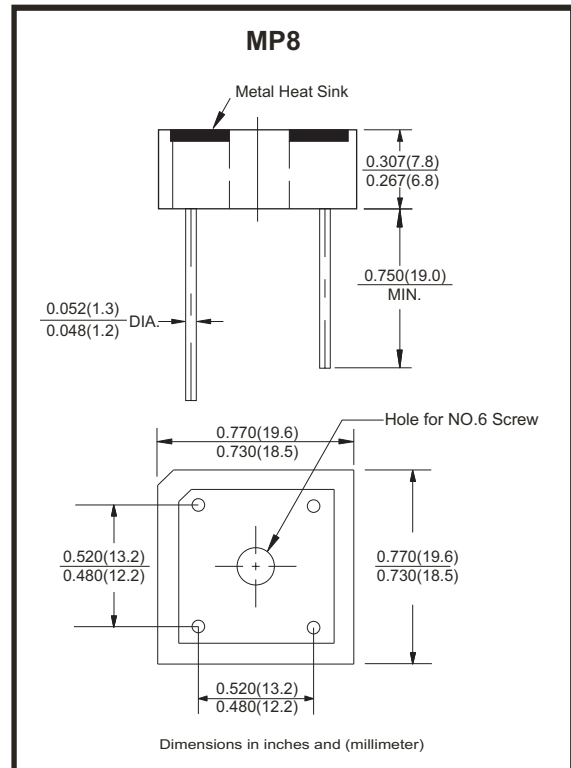

Maximum ratings and electrical characteristics

Rating at 25 °C ambient temperature unless otherwise specified.
Single phase, half wave ,60Hz, resistive or inductive load.
For capacitive load, derate current by 20%

Parameter	Symbol	MP10005G -G	MP1001G -G	MP1002G -G	MP1004G -G	MP1006G -G	MP1008G -G	MP1010G -G	Unit
Maximum Peak Recurrent Reverse Voltage	V_{RRM}	50	100	200	400	600	800	1000	V
Maximum RMS Bridge Input Voltage	V_{RMS}	35	70	140	280	420	560	700	V
Maximum DC Blocking Voltage	V_{DC}	50	100	200	400	600	800	1000	V
Maximum Average Forward Rectified Output Current @ $T_A=50^{\circ}C$	$I_{(AV)}$	10.0							A
Peak Forward Surge Current , 8.3ms Single Half Sine-Wave Super Imposed On Rated Load	I_{FSM}	175							A
Maximum Forward Voltage Drop Per Bridge Element at 5.0A Peak	V_F	1.1							V
Maximum Reverse Current at Rated DC Blocking Voltage Per Element	I_R	@ $T_J=25^{\circ}C$ 10							μA
		@ $T_J=100^{\circ}C$ 1.0							mA
Operating Temperature Range	T_J	-55 to +150							$^{\circ}C$
Storage Temperature Range	T_{STG}	-55 to +150							$^{\circ}C$

Rating and Characteristics Curves (MP10005G-G Thru. MP1010G-G)

Fig.1 Derating Curve Output Rectified Current

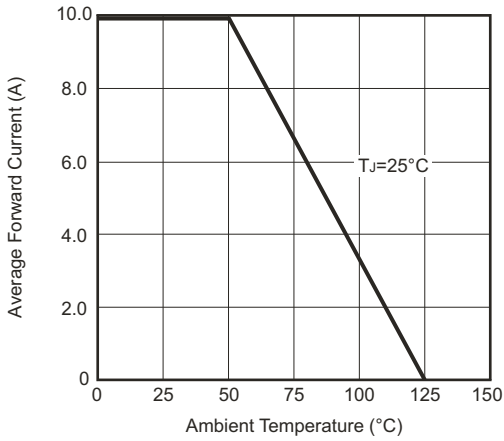

Fig.2 Maximum Forward Surge Current

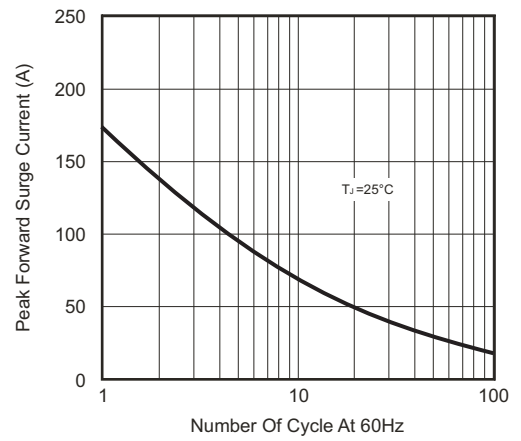

Fig.3 Typical Forward Characteristics

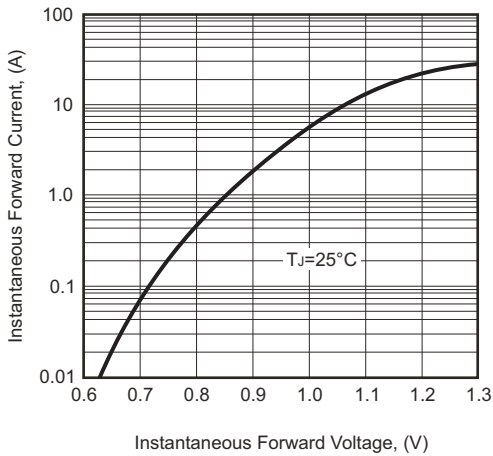
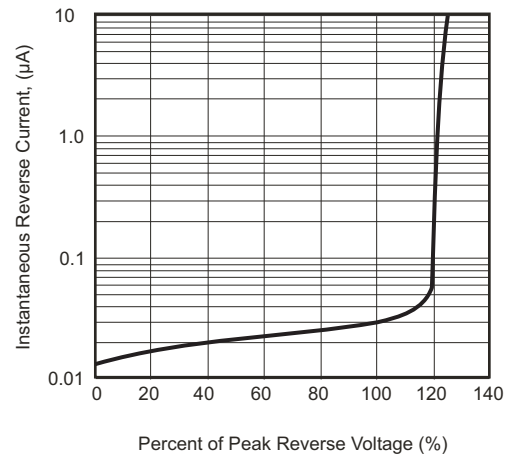
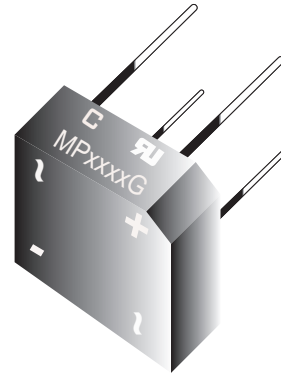

Fig.4 Typical Reverse Characteristics



Marking Code

Part Number	Marking code
MP10005-G	MP10005
MP1001-G	MP1001
MP1002-G	MP1002
MP1004-G	MP1004
MP1006-G	MP1006
MP1008-G	MP1008
MP1010-G	MP1010



XXXX / XXXXX = Product type marking code
 C = Compchip Logo

Standard Package

Case Type	BULK PACK		
	Box (EA)	Box / Carton (EA)	CARTON (EA)
MP8	200	10	2000