

RF Power LDMOS Transistor

High Ruggedness N-Channel Enhancement-Mode Lateral MOSFET

RF power transistor designed for both narrowband and broadband ISM, broadcast and aerospace applications operating at frequencies from 1.8 to 2000 MHz. This device is fabricated using Freescale's enhanced ruggedness platform and is suitable for use in applications where high VSWRs are encountered.

Typical Performance: $V_{DD} = 50$ Volts

Frequency (MHz)	Signal Type	P _{out} (W)	G _{ps} (dB)	η_D (%)	IMD (dBc)
1.8-30 (1,3)	Two-Tone (10 kHz spacing)	25 PEP	25.0	50.0	-28
30-512 (2,3)	Two-Tone (200 kHz spacing)	25 PEP	17.3	32.0	-32
512 (4)	Pulse (100 μ sec, 20% Duty Cycle)	25 Peak	25.9	74.0	—
512 (4)	CW	25	26.0	75.0	—

Load Mismatch/Ruggedness

Frequency (MHz)	Signal Type	VSWR	P _{in} (W)	Test Voltage	Result
30 (1)	CW	>65:1 at all Phase Angles	0.11 (3 dB Overdrive)	50	No Device Degradation
512 (2)	CW		0.95 (3 dB Overdrive)		
512 (4)	Pulse (100 μ sec, 20% Duty Cycle)		0.14 Peak (3 dB Overdrive)		
512 (4)	CW		0.14 (3 dB Overdrive)		

1. Measured in 1.8-30 MHz broadband reference circuit.
2. Measured in 30-512 MHz broadband reference circuit.
3. The values shown are the minimum measured performance numbers across the indicated frequency range.
4. Measured in 512 MHz narrowband test circuit.

Features

- Wide Operating Frequency Range
- Extreme Ruggedness
- Unmatched, Capable of Very Broadband Operation
- Integrated Stability Enhancements
- Low Thermal Resistance
- Extended ESD Protection Circuit
- In Tape and Reel. R5 Suffix = 50 Units, 32 mm Tape Width, 13 inch Reel.

MRFE6VS25LR5

**1.8-2000 MHz, 25 W, 50 V
 WIDEBAND
 RF POWER LDMOS TRANSISTOR**

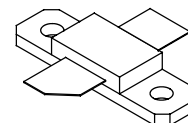

NI-360-2

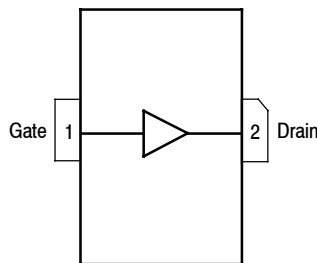

(Top View)

Note: The backside of the package is the source terminal for the transistor.

Figure 1. Pin Connections

Table 1. Maximum Ratings

Rating	Symbol	Value	Unit
Drain-Source Voltage	V_{DSS}	-0.5, +133	Vdc
Gate-Source Voltage	V_{GS}	-6.0, +10	Vdc
Storage Temperature Range	T_{stg}	-65 to +150	°C
Case Operating Temperature Range	T_C	-40 to +150	°C
Operating Junction Temperature Range (1,2)	T_J	-40 to +225	°C

Table 2. Thermal Characteristics

Characteristic	Symbol	Value (2,3)	Unit
Thermal Resistance, Junction to Case CW: Case Temperature 81°C, 25 W CW, 50 Vdc, $I_{DQ} = 10$ mA, 512 MHz	$R_{\theta JC}$	1.4	°C/W
Thermal Impedance, Junction to Case Pulse: Case Temperature 77°C, 25 W Peak, 100 μ sec Pulse Width, 20% Duty Cycle, 50 Vdc, $I_{DQ} = 10$ mA, 512 MHz	$Z_{\theta JC}$	0.32	°C/W

Table 3. ESD Protection Characteristics

Test Methodology	Class
Human Body Model (per JESD22-A114)	2, passes 2000 V
Machine Model (per EIA/JESD22-A115)	B, passes 200 V
Charge Device Model (per JESD22-C101)	IV, passes 1200 V

Table 4. Electrical Characteristics ($T_A = 25^\circ\text{C}$ unless otherwise noted)

Characteristic	Symbol	Min	Typ	Max	Unit
----------------	--------	-----	-----	-----	------

Off Characteristics

Gate-Source Leakage Current ($V_{GS} = 5$ Vdc, $V_{DS} = 0$ Vdc)	I_{GSS}	—	—	400	nAdc
Drain-Source Breakdown Voltage ($V_{GS} = 0$ Vdc, $I_D = 50$ mA)	$V_{(BR)DSS}$	133	140	—	Vdc
Zero Gate Voltage Drain Leakage Current ($V_{DS} = 50$ Vdc, $V_{GS} = 0$ Vdc)	I_{DSS}	—	—	2	μ Adc
Zero Gate Voltage Drain Leakage Current ($V_{DS} = 100$ Vdc, $V_{GS} = 0$ Vdc)	I_{DSS}	—	—	7	μ Adc

On Characteristics

Gate Threshold Voltage ($V_{DS} = 10$ Vdc, $I_D = 85$ μ Adc)	$V_{GS(th)}$	1.5	2.0	2.5	Vdc
Gate Quiescent Voltage ($V_{DD} = 50$ Vdc, $I_D = 10$ mAdc, Measured in Functional Test)	$V_{GS(Q)}$	2.0	2.4	3.0	Vdc
Drain-Source On-Voltage ($V_{GS} = 10$ Vdc, $I_D = 210$ mAdc)	$V_{DS(on)}$	—	0.23	—	Vdc

Dynamic Characteristics

Reverse Transfer Capacitance ($V_{DS} = 50$ Vdc \pm 30 mV(rms)ac @ 1 MHz, $V_{GS} = 0$ Vdc)	C_{rss}	—	0.17	—	pF
Output Capacitance ($V_{DS} = 50$ Vdc \pm 30 mV(rms)ac @ 1 MHz, $V_{GS} = 0$ Vdc)	C_{oss}	—	14.7	—	pF
Input Capacitance ($V_{DS} = 50$ Vdc, $V_{GS} = 0$ Vdc \pm 30 mV(rms)ac @ 1 MHz)	C_{iss}	—	39.0	—	pF

1. Continuous use at maximum temperature will affect MTTF.
2. MTTF calculator available at <http://www.freescale.com/rtf>. Select Software & Tools/Development Tools/Calculators to access MTTF calculators by product.
3. Refer to AN1955, *Thermal Measurement Methodology of RF Power Amplifiers*. Go to <http://www.freescale.com/rtf>. Select Documentation/Application Notes - AN1955.

(continued)

Table 4. Electrical Characteristics ($T_A = 25^\circ\text{C}$ unless otherwise noted) (continued)

Characteristic	Symbol	Min	Typ	Max	Unit
Functional Tests (In Freescale Test Fixture, 50 ohm system) $V_{DD} = 50\text{ Vdc}$, $I_{DQ} = 10\text{ mA}$, $P_{out} = 25\text{ W Peak}$ (5 W Avg.), $f = 512\text{ MHz}$, Pulse, 100 μsec Pulse Width, 20% Duty Cycle					
Power Gain	G_{ps}	24.5	25.9	27.5	dB
Drain Efficiency	η_D	70.0	74.0	—	%
Input Return Loss	IRL	—	-16	-10	dB

Load Mismatch/Ruggedness (In Freescale Test Fixture, 50 ohm system) $I_{DQ} = 150\text{ mA}$

Frequency (MHz)	Signal Type	VSWR	P_{in} (W)	Test Voltage, V_{DD}	Result
512	Pulse (100 μsec , 20% Duty Cycle)	>65:1 at all Phase Angles	0.14 Peak (3 dB Overdrive)	50	No Device Degradation
	CW		0.14 (3 dB Overdrive)		

TYPICAL CHARACTERISTICS

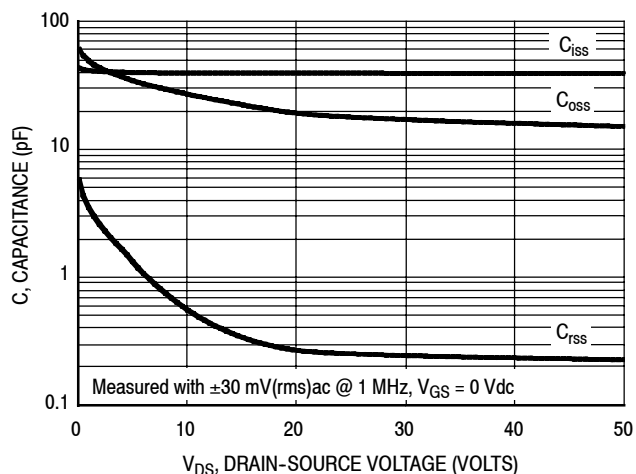
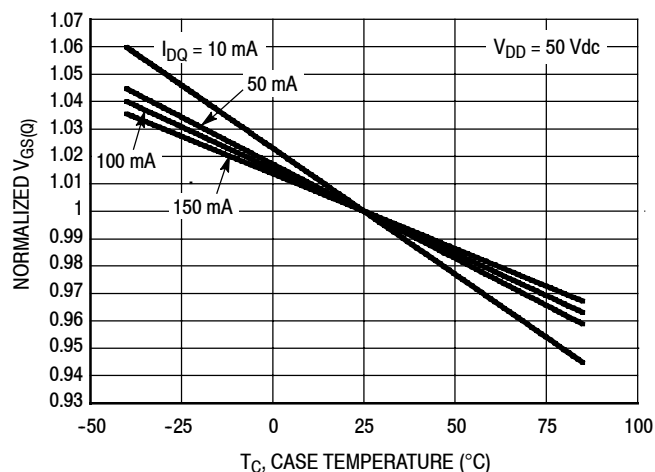
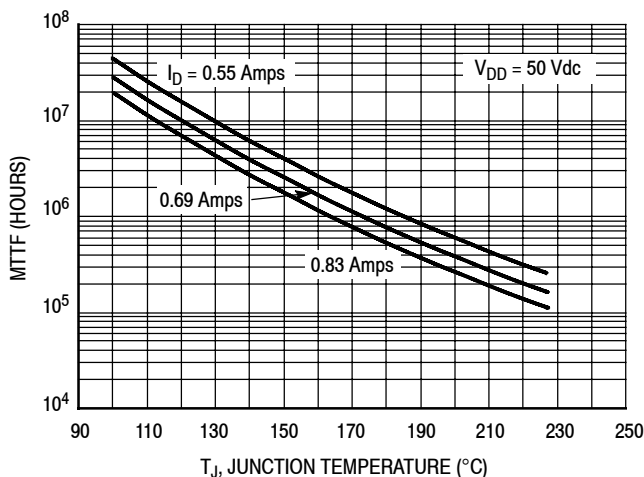

Figure 2. Capacitance versus Drain-Source Voltage



I_{DQ} (mA)	Slope (mV/°C)
10	-2.16
50	-1.79
100	-1.76
150	-1.68

Figure 3. Normalized V_{GS} versus Quiescent Current and Case Temperature



Note: MTTF value represents the total cumulative operating time under indicated test conditions.

MTTF calculator available at <http://www.freescale.com/rf>. Select Software & Tools/Development Tools/Calculators to access MTTF calculators by product.

NOTE: For pulse applications or CW conditions, use the MTTF calculator referenced above.

Figure 4. MTTF versus Junction Temperature - CW

512 MHz NARROWBAND PRODUCTION TEST FIXTURE

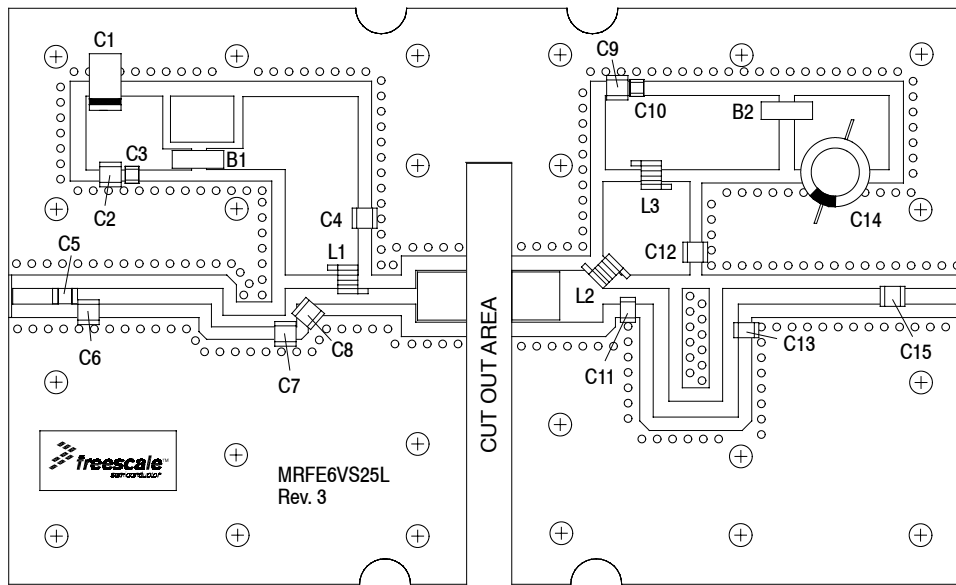

Figure 5. MRFE6VS25LR5 Narrowband Test Circuit Component Layout — 512 MHz

Table 5. MRFE6VS25LR5 Narrowband Test Circuit Component Designations and Values — 512 MHz

Part	Description	Part Number	Manufacturer
B1, B2	Long Ferrite Beads	2743021447	Fair-Rite
C1	22 μ F, 35 V Tantalum Capacitor	T491X226K035AT	Kemet
C2, C9	0.1 μ F Chip Capacitors	CDR33BX104AKWS	AVX
C3, C10	0.01 μ F Chip Capacitors	C0805C103K5RAC	Kemet
C4, C12, C15	180 pF Chip Capacitors	ATC100B181JT500XT	ATC
C5	18 pF Chip Capacitor	ATC100B180JT500XT	ATC
C6	2.7 pF Chip Capacitor	ATC100B2R7BT500XT	ATC
C7	15 pF Chip Capacitor	ATC100B150JT500XT	ATC
C8	36 pF Chip Capacitor	ATC100B360JT500XT	ATC
C11	4.3 pF Chip Capacitor	ATC100B4R3CT500XT	ATC
C13	13 pF Chip Capacitor	ATC100B130JT500XT	ATC
C14	470 μ F, 63 V Electrolytic Capacitor	MCGPR63V477M13X26-RH	Multicomp
L1	33 nH Inductor	1812SMS-33NJLC	Coilcraft
L2	12.5 nH Inductor	A04TJLC	Coilcraft
L3	82 nH Inductor	1812SMS-82NJLC	Coilcraft
PCB	0.030", $\epsilon_r = 2.55$	AD255A	Arlon

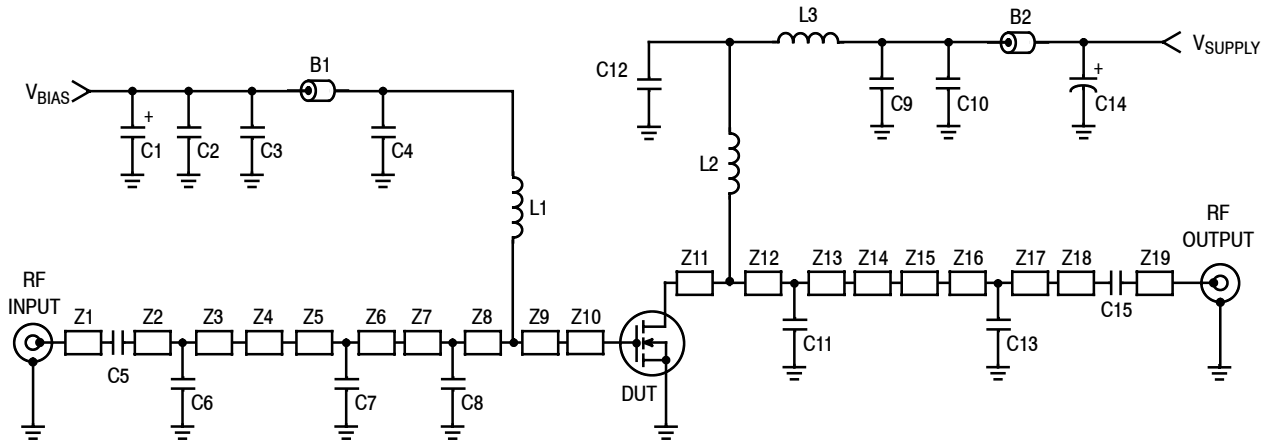

Figure 6. MRFE6VS25LR5 Narrowband Test Circuit Schematic — 512 MHz

Table 6. MRFE6VS25LR5 Narrowband Test Circuit Microstrips — 512 MHz

Microstrip	Description	Microstrip	Description
Z1	0.235" × 0.082" Microstrip	Z11	0.475" × 0.270" Microstrip
Z2	0.042" × 0.082" Microstrip	Z12	0.091" × 0.082" Microstrip
Z3	0.682" × 0.082" Microstrip	Z13	0.170" × 0.082" Microstrip
Z4*	0.200" × 0.060" Microstrip	Z14*	0.670" × 0.082" Microstrip
Z5	0.324" × 0.060" Microstrip	Z15	0.280" × 0.082" Microstrip
Z6*	0.200" × 0.060" Microstrip	Z16*	0.413" × 0.082" Microstrip
Z7	0.089" × 0.082" Microstrip	Z17*	0.259" × 0.082" Microstrip
Z8	0.120" × 0.082" Microstrip	Z18	0.761" × 0.082" Microstrip
Z9	0.411" × 0.082" Microstrip	Z19	0.341" × 0.082" Microstrip
Z10	0.260" × 0.270" Microstrip		

* Line length includes microstrip bends

TYPICAL CHARACTERISTICS — 512 MHz

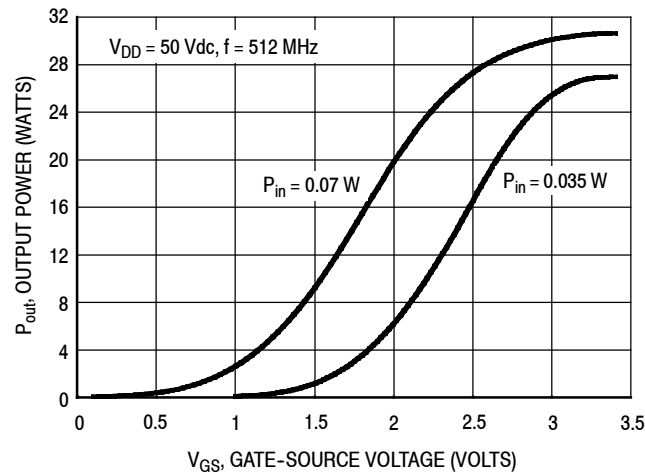
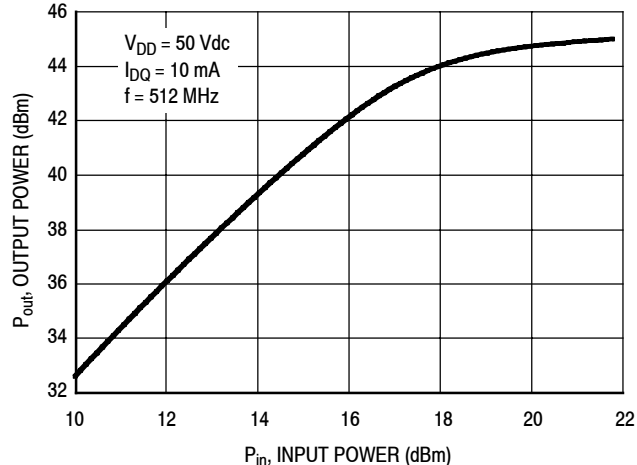

Figure 7. CW Output Power versus Gate-Source Voltage at a Constant Input Power



f (MHz)	P1dB (W)	P3dB (W)
512	28.7	31.6

Figure 8. CW Output Power versus Input Power

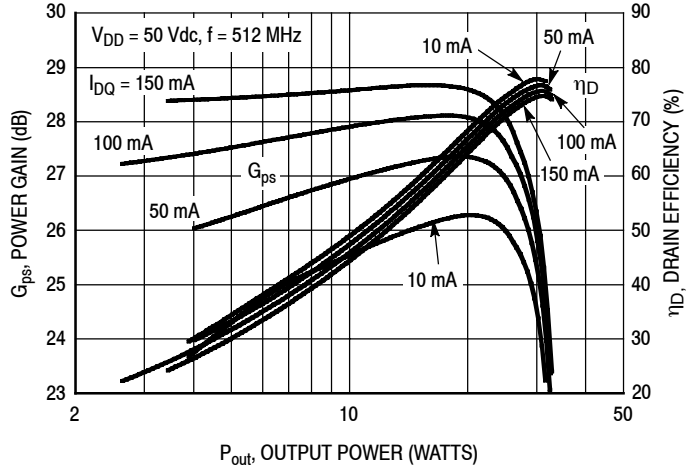

Figure 9. Power Gain and Drain Efficiency versus CW Output Power and Quiescent Current

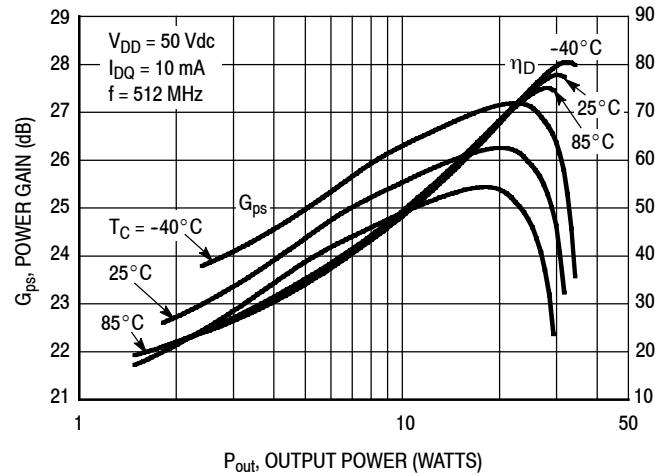

Figure 10. Power Gain and Drain Efficiency versus CW Output Power

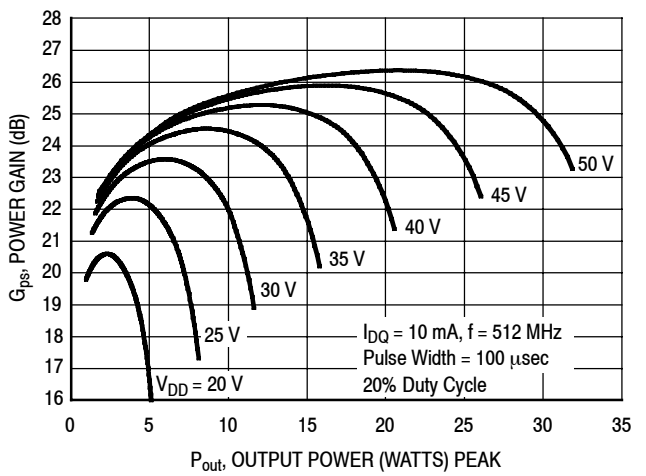

Figure 11. Power Gain versus Output Power and Drain-Source Voltage

512 MHz NARROWBAND PRODUCTION TEST FIXTURE

$V_{DD} = 50 \text{ Vdc}$, $I_{DQ} = 10 \text{ mA}$, $P_{out} = 25 \text{ W Peak}$

f MHz	Z_{source} Ω	Z_{load} Ω
512	$0.72 + j10.8$	$8.8 + j17.5$

Z_{source} = Test circuit impedance as measured from gate to ground.

Z_{load} = Test circuit impedance as measured from drain to ground.

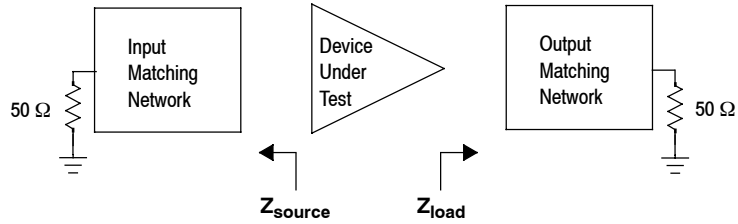

Figure 12. Narrowband Series Equivalent Source and Load Impedance — 512 MHz

1.8-30 MHz HF BROADBAND REFERENCE CIRCUIT

Table 7. 1.8-30 MHz HF Broadband Performance (In Freescale Reference Circuit, 50 ohm system)
 $V_{DD} = 50$ Volts, $I_{DQ} = 100$ mA

Signal Type	P_{out} (W)	f (MHz)	G_{ps} (dB)	η_D (%)	IMD (dBc)
Two-Tone (10 kHz spacing)	25 PEP	1.8	25.8	51.5	-28.7
		10	25.9	50.4	-33.9
		30	25.0	50.7	-31.1

Table 8. Load Mismatch/Ruggedness (In Freescale Reference Circuit)

Frequency (MHz)	Signal Type	VSWR	P_{in} (W)	Test Voltage, V_{DD}	Result
30	CW	>65:1 at all Phase Angles	0.11 (3 dB Overdrive)	50	No Device Degradation

1.8-30 MHz HF BROADBAND REFERENCE CIRCUIT

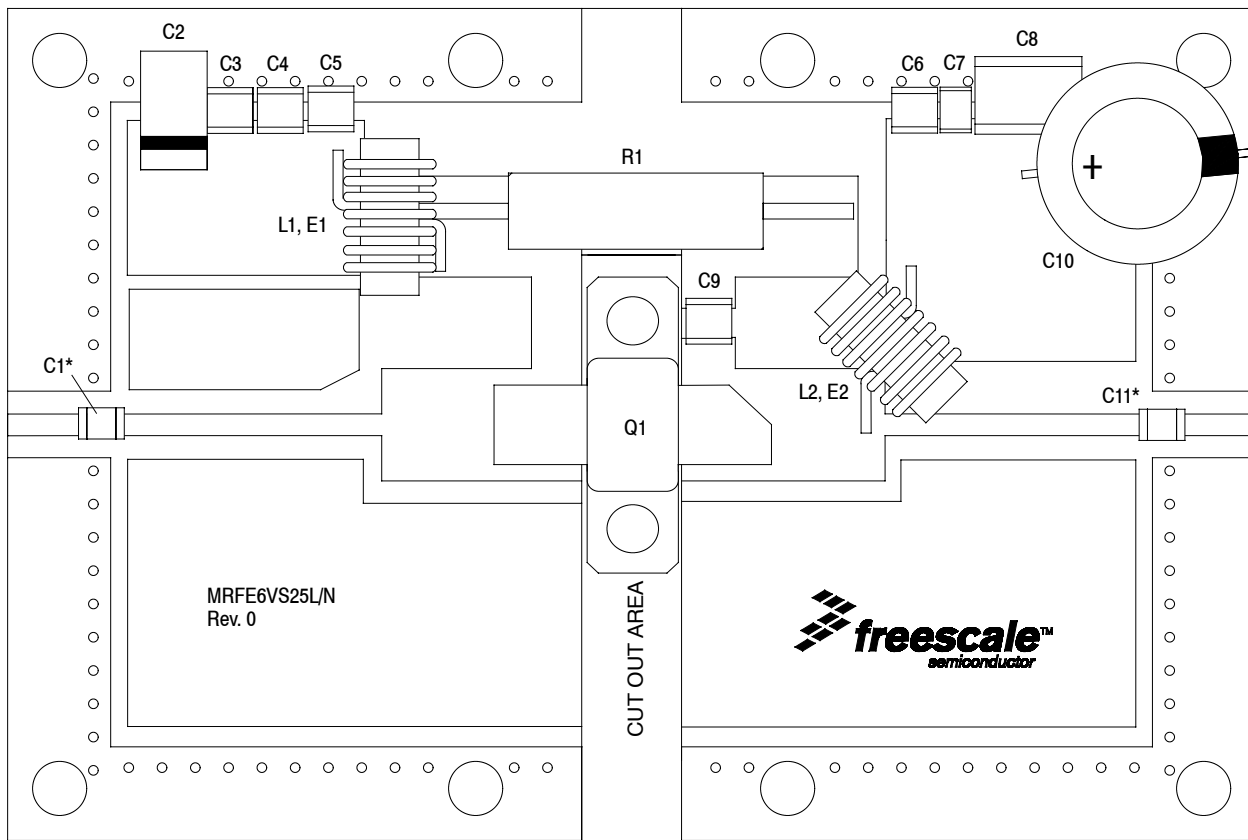

*C1 and C11 are mounted vertically.

Figure 13. MRFE6VS25LR5 HF Broadband Reference Circuit Component Layout — 1.8-30 MHz

Table 9. MRFE6VS25LR5 HF Broadband Reference Circuit Component Designations and Values — 1.8-30 MHz

Part	Description	Part Number	Manufacturer
C1, C5, C6, C9, C11	20K pF Chip Capacitors	ATC200B203KT50XT	ATC
C2	10 μ F, 35 V Tantalum Capacitor	T491D106K035AT	Kemet
C3	0.1 μ F Chip Capacitor	CDR33BX104AKWY	AVX
C4	2.2 μ F Chip Capacitor	C3225X7R1H225KT	TDK
C7	0.1 μ F Chip Capacitor	GRM319R72A104KA01D	Murata
C8	2.2 μ F Chip Capacitor	G2225X7R225KT3AB	ATC
C10	220 μ F, 100 V Electrolytic Capacitor	MCGPR100V227M16X26-RH	Multicomp
E1	#43 Ferrite Toroid	5943001101	Fair-Rite
E2	#61 Ferrite Toroid	5961001101	Fair-Rite
L1	4 Turns, 22 AWG, Toroid Transformer with Ferrite E1	8077 Copper Magnetic Wire	Belden
L2	26 Turns, 22 AWG, Toroid Transformer with Ferrite E2	8077 Copper Magnetic Wire	Belden
Q1	RF Power LDMOS Transistor	MRFE6VS25LR1	Freescale
R1	1 k Ω , 3 W Chip Resistor	CPF31K0000FKE14	Vishay
PCB	0.030", $\epsilon_r = 4.8$	S1000	Shenzhen Multilayer PCB Technology

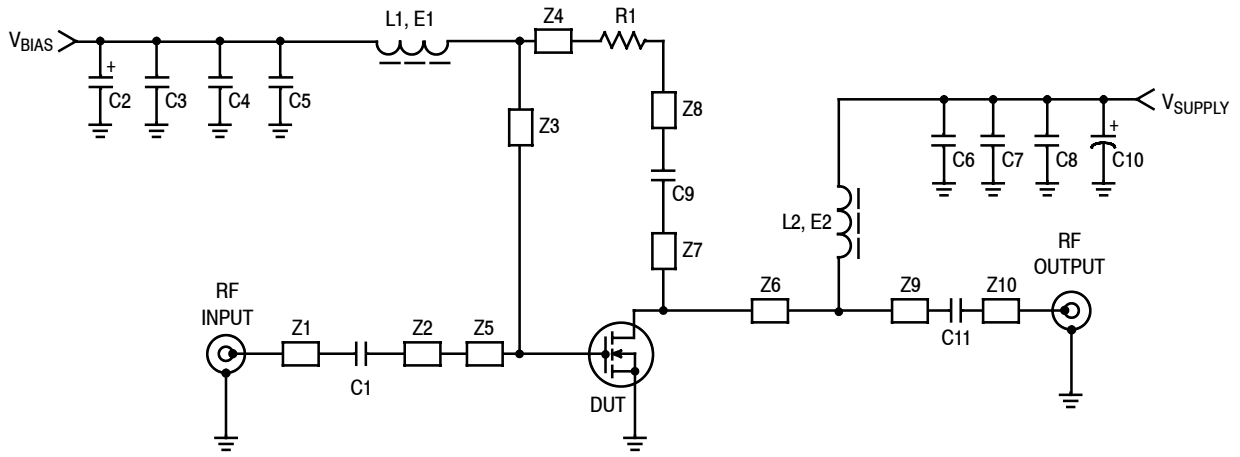

Figure 14. MRFE6VS25LR5 HF Broadband Reference Circuit Schematic — 1.8-30 MHz

Table 10. MRFE6VS25LR5 HF Broadband Reference Circuit Microstrips — 1.8-30 MHz

Microstrip	Description	Microstrip	Description
Z1	0.141" × 0.047" Microstrip	Z6	0.469" × 0.263" Microstrip
Z2	0.625" × 0.047" Microstrip	Z7	0.119" × 0.063" Microstrip
Z3	0.119" × 0.219" Microstrip	Z8	0.422" × 0.241" Microstrip
Z4	0.422" × 0.241" Microstrip	Z9	0.625" × 0.047" Microstrip
Z5	0.469" × 0.263" Microstrip	Z10	0.141" × 0.047" Microstrip

**TYPICAL CHARACTERISTICS — 1.8-30 MHz
HF BROADBAND REFERENCE CIRCUIT**

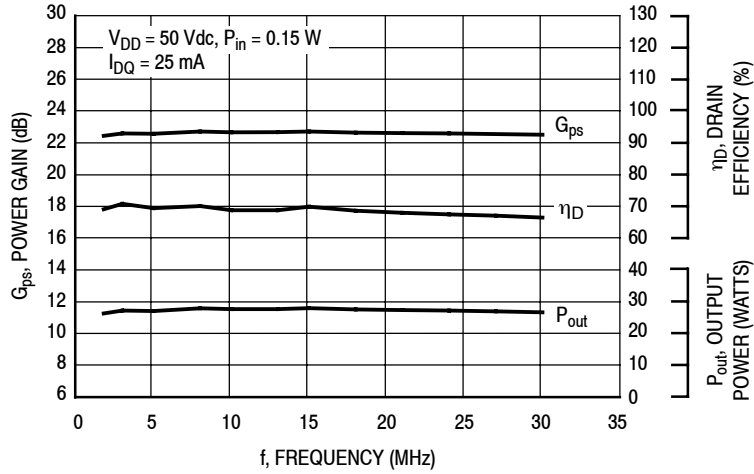

Figure 15. Power Gain, CW Output Power and Drain Efficiency versus Frequency at a Constant Input Power

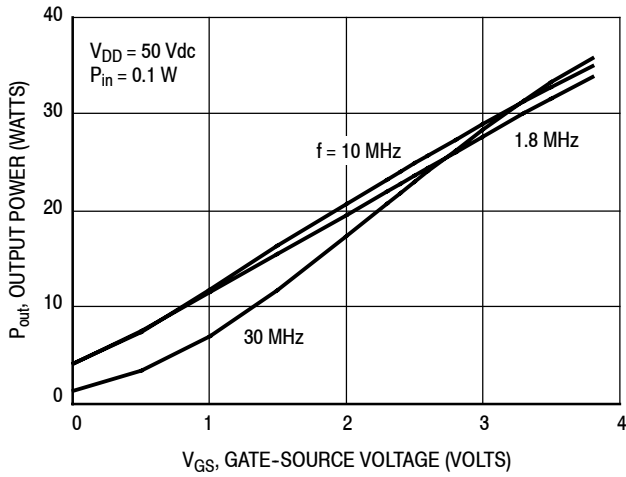

Figure 16. CW Output Power versus Gate-Source Voltage at a Constant Input Power

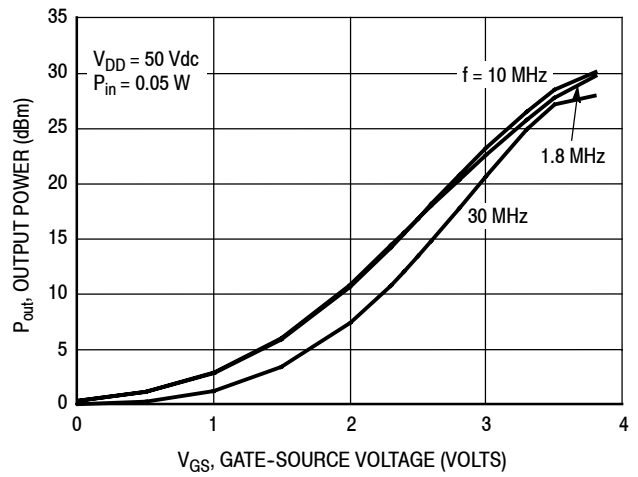
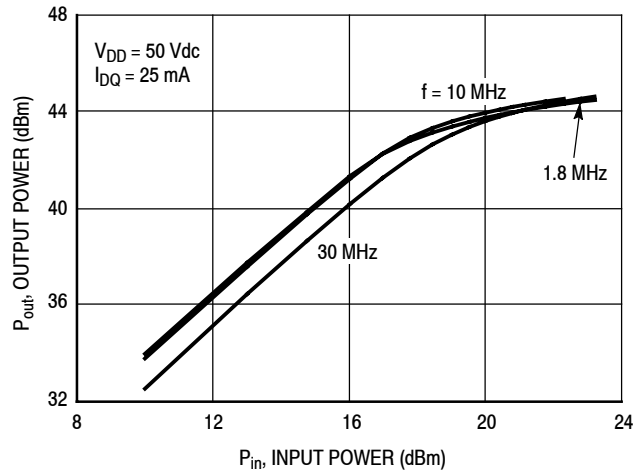

Figure 17. CW Output Power versus Gate-Source Voltage at a Constant Input Power

TYPICAL CHARACTERISTICS — 1.8-30 MHz HF BROADBAND REFERENCE CIRCUIT



f (MHz)	P1dB (W)	P3dB (W)
1.8	21.9	26.4
10	24.0	28.4
30	23.9	29.1

Figure 18. CW Output Power versus Input Power

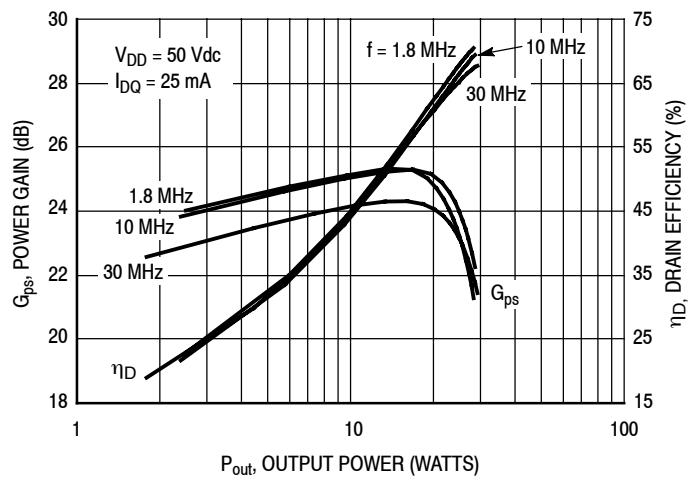

Figure 19. Power Gain and Drain Efficiency versus CW Output Power

**TYPICAL CHARACTERISTICS — 1.8-30 MHz
HF BROADBAND REFERENCE CIRCUIT — TWO-TONE (1)**

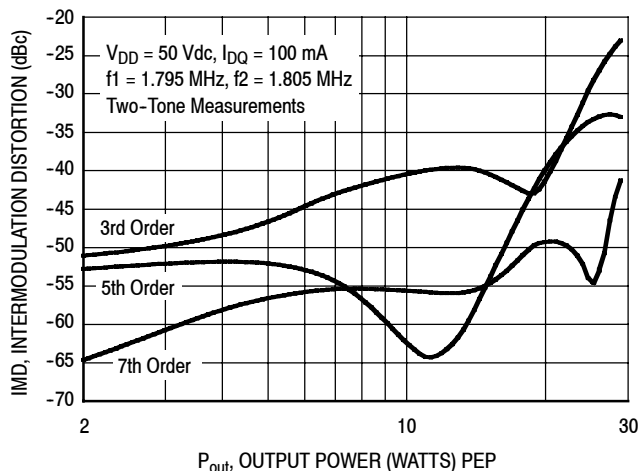

Figure 20. Intermodulation Distortion Products versus Output Power — 1.8 MHz

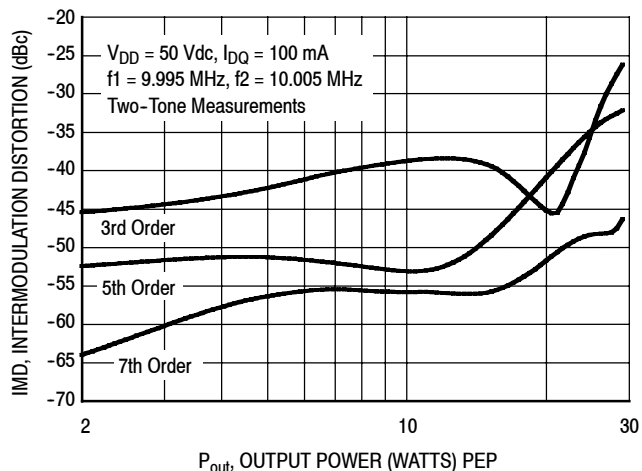

Figure 21. Intermodulation Distortion Products versus Output Power — 10 MHz

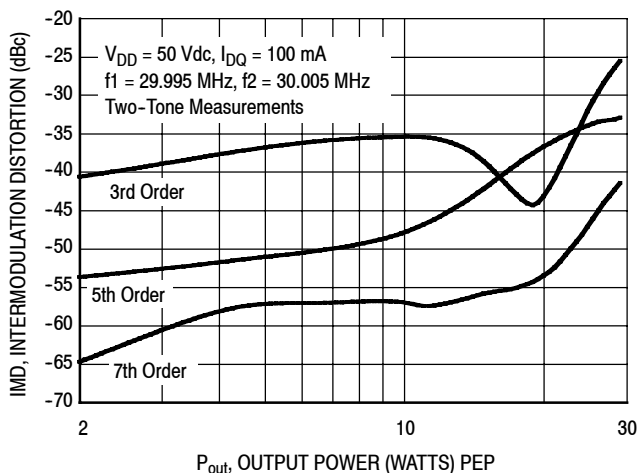
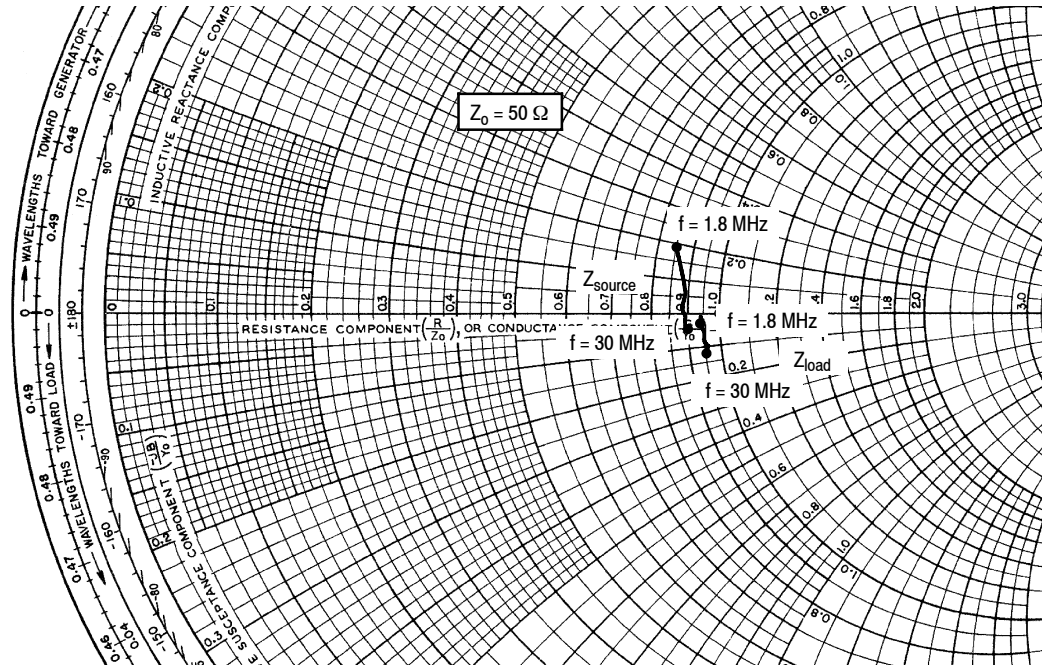

Figure 22. Intermodulation Distortion Products versus Output Power — 30 MHz

1. The distortion products are referenced to one of the two tones and the peak envelope power (PEP) is 6 dB above the power in a single tone.

1.8-30 MHz HF BROADBAND REFERENCE CIRCUIT



$V_{DD} = 50 \text{ Vdc}$, $I_{DQ} = 25 \text{ mA}$, $P_{out} = 25 \text{ W CW}$

f MHz	Z_{source} Ω	Z_{load} Ω
1.8	42.4 + j9.5	47.1 - j1.6
5	44.3 + j3.0	46.8 - j1.2
10	44.2 + j0.4	47.2 - j2.1
15	44.4 - j0.5	47.5 - j3.2
20	44.6 - j1.3	47.7 - j4.3
25	44.8 - j2.0	47.8 - j5.2
30	44.9 - j2.5	47.7 - j6.1

Z_{source} = Test circuit impedance as measured from gate to ground.

Z_{load} = Test circuit impedance as measured from drain to ground.

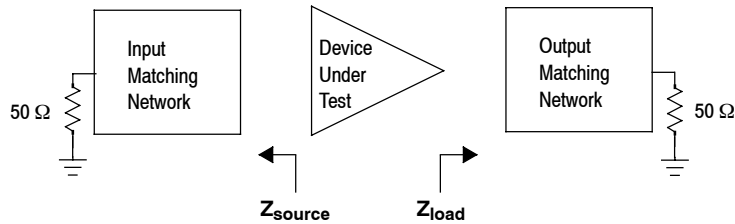

Figure 23. HF Broadband Series Equivalent Source and Load Impedance — 1.8-30 MHz

30-512 MHz BROADBAND REFERENCE CIRCUIT

Table 11. 30-512 MHz Broadband Performance (In Freescale Reference Circuit, 50 ohm system)

$V_{DD} = 50$ Volts, $I_{DQ} = 100$ mA

Signal Type	P_{out} (W)	f (MHz)	G_{ps} (dB)	η_D (%)	IMD (dBc)
Two-Tone (200 kHz spacing)	25 PEP	30	20.9	34.2	-32.3
		100	19.0	38.2	-31.5
		512	17.3	32.0	-36.1

Table 12. Load Mismatch/Ruggedness (In Freescale Reference Circuit)

Frequency (MHz)	Signal Type	VSWR	P_{in} (W)	Test Voltage, V_{DD}	Result
512	CW	>65:1 at all Phase Angles	0.95 (3 dB Overdrive)	50	No Device Degradation

30-512 MHz BROADBAND REFERENCE TEST FIXTURE

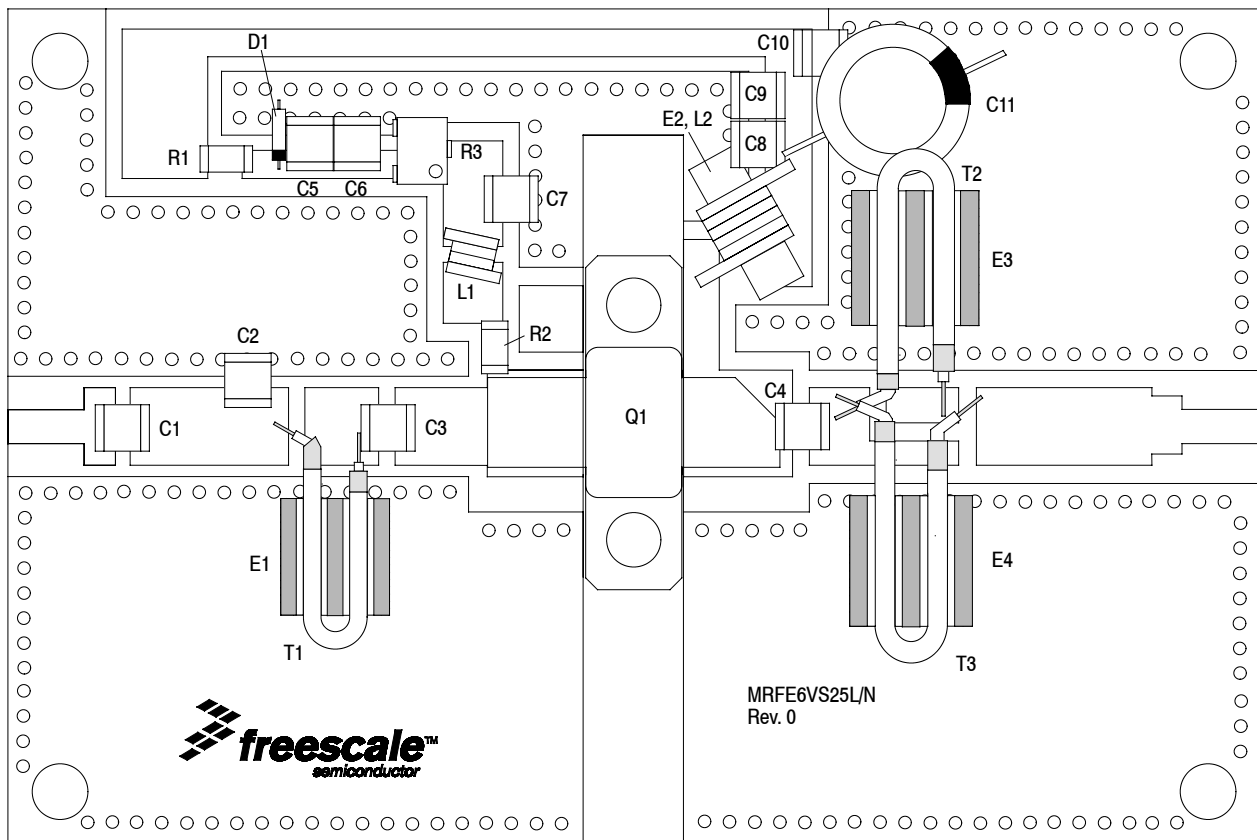

Note: See Figure 24a for a more detailed view of the semi-flex cables with shields and #61 multi-aperture cores.

Figure 24. MRFE6VS25LR5 Broadband Reference Circuit Component Layout — 30-512 MHz

Table 13. MRFE6VS25LR5 Broadband Reference Circuit Component Designations and Values — 30-512 MHz

Part	Description	Part Number	Manufacturer
C1, C3, C6, C7, C8	1,000 pF Chip Capacitors	ATC100B102JT50XT	ATC
C2	2.7 pF Chip Capacitor	ATC100B2R7BT500XT	ATC
C4	15 nF Chip Capacitor	C3225CH2A153JT	TDK
C5, C9	10 nF Chip Capacitors	GRM3195C1E103JA01	Murata
C10	1 μ F Chip Capacitor	C3225JB2A105KT	TDK
C11	220 μ F, 100 V Electrolytic Capacitor	MCGPR100V227M16X26-RH	Multicomp
D1	8.2 V, 1 W Zener Diode	1N4738A	Fairchild Semiconductor
E1, E3, E4	#61 Multi-aperture Cores	2861001502	Fair-Rite
E2	Ferrite Core Bead	21-201-J	Ferronics
L1	47 nH Inductor	1812SMS-47NJLC	Coilcraft
L2	4 Turns, 20 AWG, Toroid Transformer with Ferrite E2	8076 Copper Magnetic Wire	Belden
R1	5.6 K Ω , 1/4 W Chip Resistor	CRCW12065K60FKEA	Vishay
R2	15 Ω , 1/4 W Chip Resistor	CRCW120615R0FKEA	Vishay
R3	5 k Ω Potentiometer CMS Cermet Multi-turn	3224W-1-502E	Bourns
T1	25 Ω Semi-flex Cable, 0.945" Shield Length	D260-4118-0000	Microdot
T2, T3	25 Ω Semi-flex Cables, 1.340" Shield Length	D260-4118-0000	Microdot
PCB	0.030", $\epsilon_r = 3.5$	TC350	Arlon

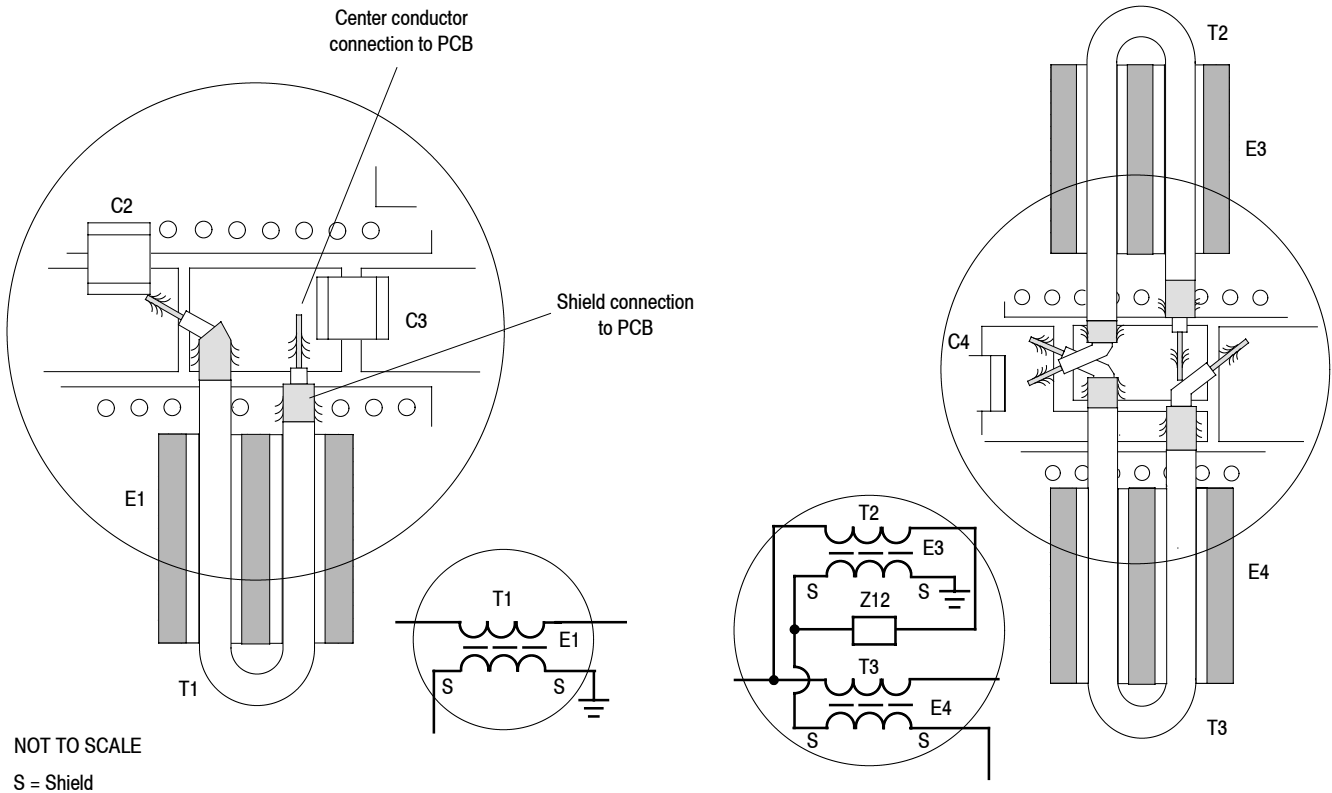

Figure 24a. Detailed View of Semi-flex Cables with Shields and #61 Multi-aperture Cores

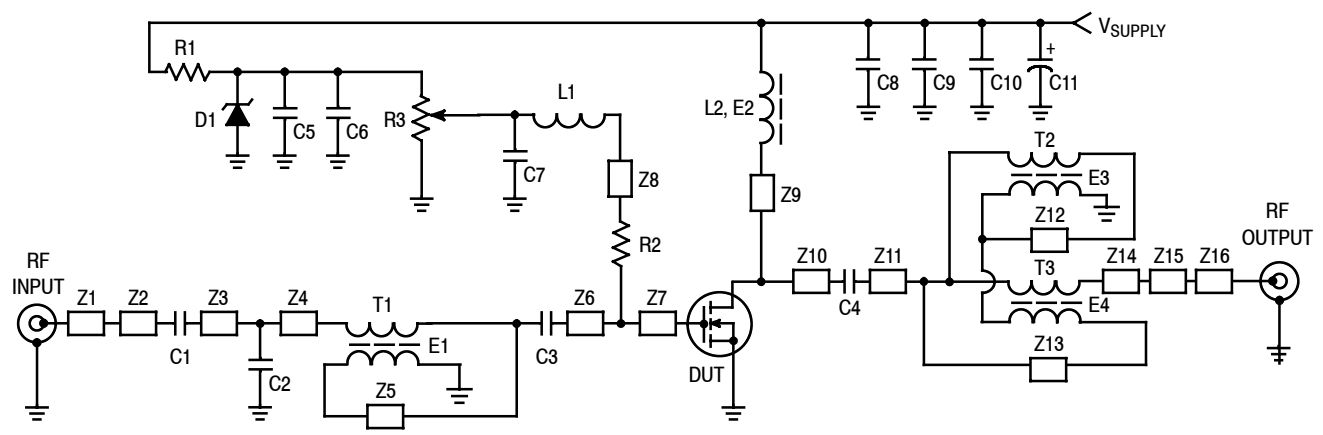

Figure 25. MRFE6VS25LR5 Broadband Reference Circuit Schematic — 30-512 MHz

Table 14. MRFE6VS25LR5 Broadband Reference Circuit Microstrips — 30-512 MHz

Microstrip	Description	Microstrip	Description
Z1	0.180" × 0.080" Microstrip	Z9	0.080" × 0.310" Microstrip
Z2	0.080" × 0.190" Microstrip	Z10	0.260" × 0.260" Microstrip
Z3	0.230" × 0.190" Microstrip	Z11	0.140" × 0.190" Microstrip
Z4	0.150" × 0.190" Microstrip	Z12	0.170" × 0.080" Microstrip
Z5	0.180" × 0.190" Microstrip	Z13	0.210" × 0.060" Microstrip
Z6	0.220" × 0.190" Microstrip	Z14	0.420" × 0.190" Microstrip
Z7	0.230" × 0.260" Microstrip	Z15	0.070" × 0.140" Microstrip
Z8	0.140" × 0.150" Microstrip	Z16	0.190" × 0.080" Microstrip

TYPICAL CHARACTERISTICS — 30-512 MHz BROADBAND REFERENCE CIRCUIT

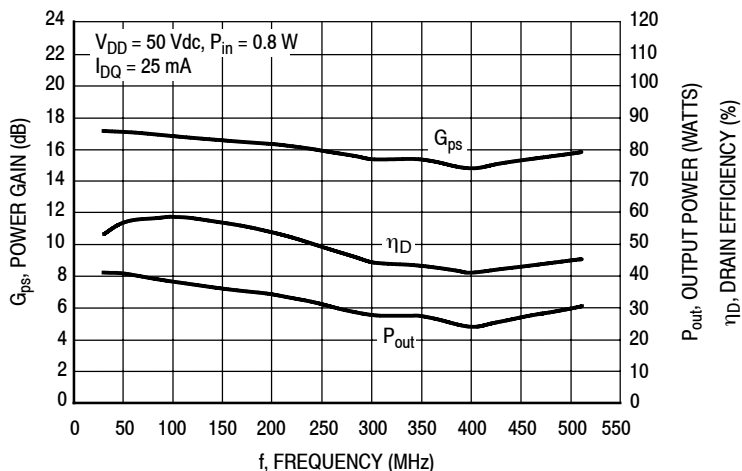

Figure 26. Power Gain, CW Output Power and Drain Efficiency versus Frequency at a Constant Input Power

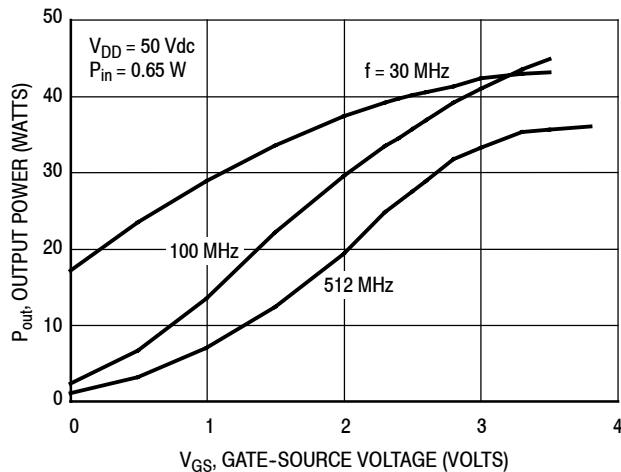

Figure 27. CW Output Power versus Gate-Source Voltage at a Constant Input Power

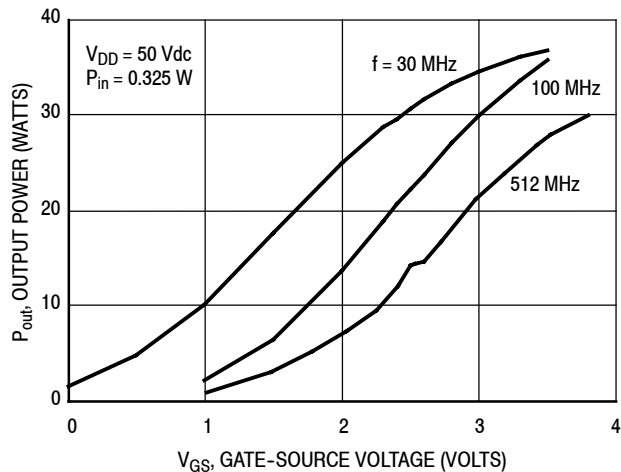
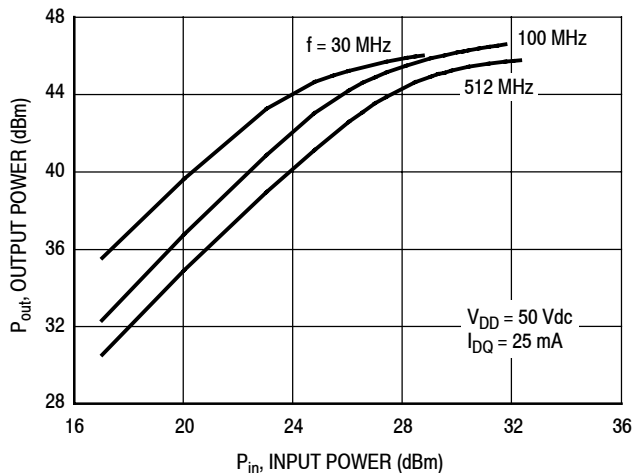

Figure 28. CW Output Power versus Gate-Source Voltage at a Constant Input Power

TYPICAL CHARACTERISTICS — 30-512 MHz BROADBAND REFERENCE CIRCUIT



f (MHz)	P1dB (W)	P3dB (W)
30	33.4	40.2
100	35.6	44.6
512	32.7	37.7

Figure 29. CW Output Power versus Input Power

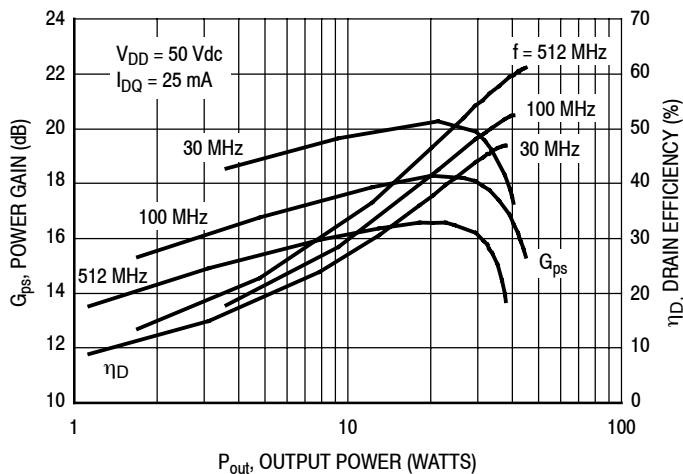

Figure 30. Power Gain and Drain Efficiency versus CW Output Power

**TYPICAL CHARACTERISTICS — 30-512 MHz
BROADBAND REFERENCE CIRCUIT — TWO-TONE (1)**

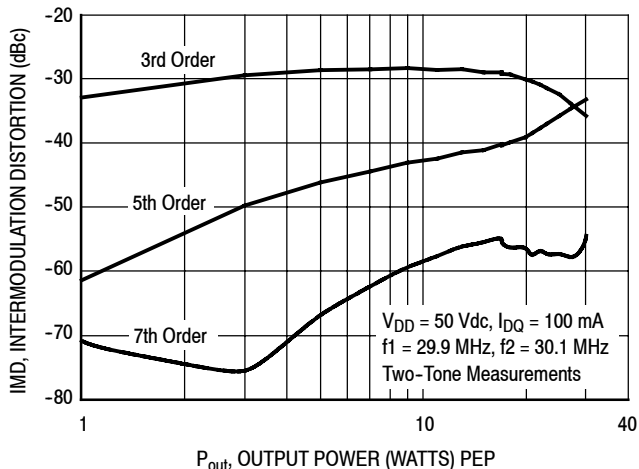

Figure 31. Intermodulation Distortion Products versus Output Power — 30 MHz

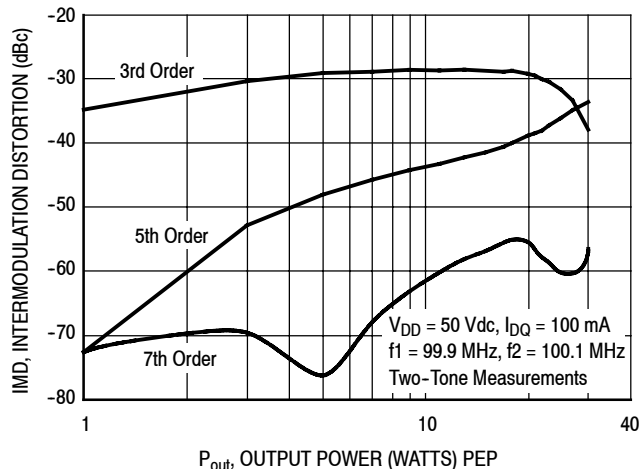

Figure 32. Intermodulation Distortion Products versus Output Power — 100 MHz

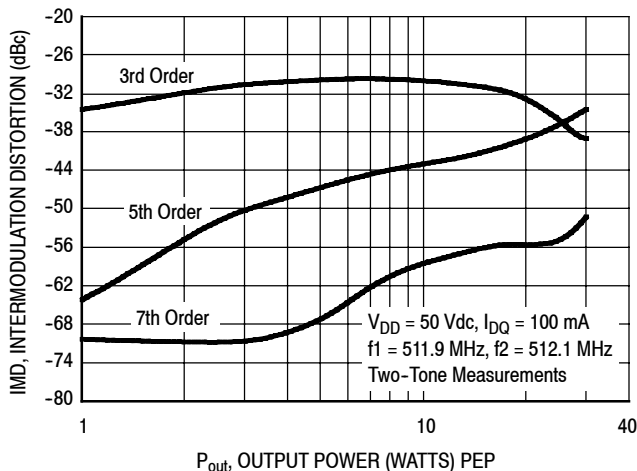
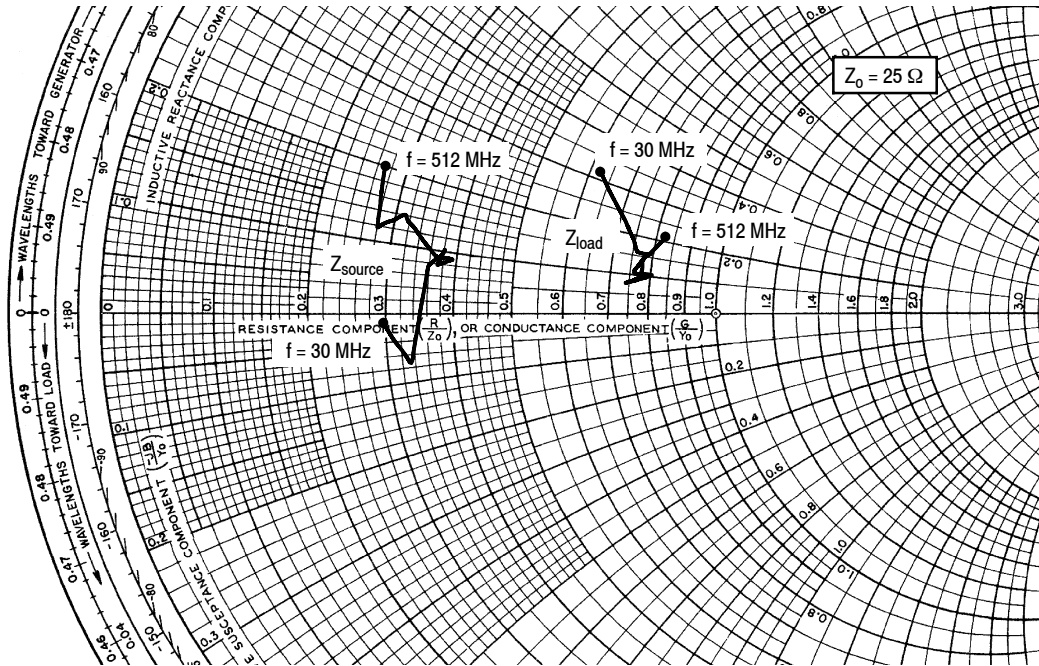

Figure 33. Intermodulation Distortion Products versus Output Power — 512 MHz

1. The distortion products are referenced to one of the two tones and the peak envelope power (PEP) is 6 dB above the power in a single tone.

30-512 MHz BROADBAND REFERENCE CIRCUIT



$V_{DD} = 50 \text{ Vdc}$, $I_{DQ} = 25 \text{ mA}$, $P_{out} = 25 \text{ W CW}$

f MHz	Z_{source} Ω	Z_{load} Ω
30	$7.2 - j0.6$	$15.4 + j8.1$
64	$8.2 - j1.7$	$18.1 + j5.4$
88	$8.9 + j1.9$	$19.0 + j3.9$
98	$9.2 + j2.2$	$19.3 + j3.9$
100	$9.2 + j2.2$	$19.4 + j4.0$
108	$9.4 + j2.4$	$19.8 + j4.1$
144	$9.3 + j1.9$	$19.1 + j2.8$
170	$9.8 + j2.2$	$20.0 + j2.6$
230	$8.9 + j2.1$	$18.6 + j2.0$
352	$7.8 + j3.5$	$19.2 + j2.6$
450	$7.0 + j3.1$	$19.2 + j3.5$
512	$6.7 + j5.0$	$20.5 + j5.3$

Z_{source} = Test circuit impedance as measured from gate to ground.

Z_{load} = Test circuit impedance as measured from drain to ground.

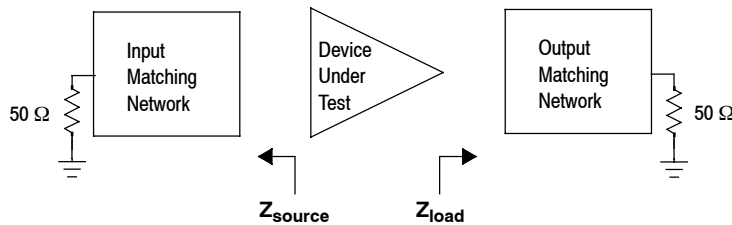
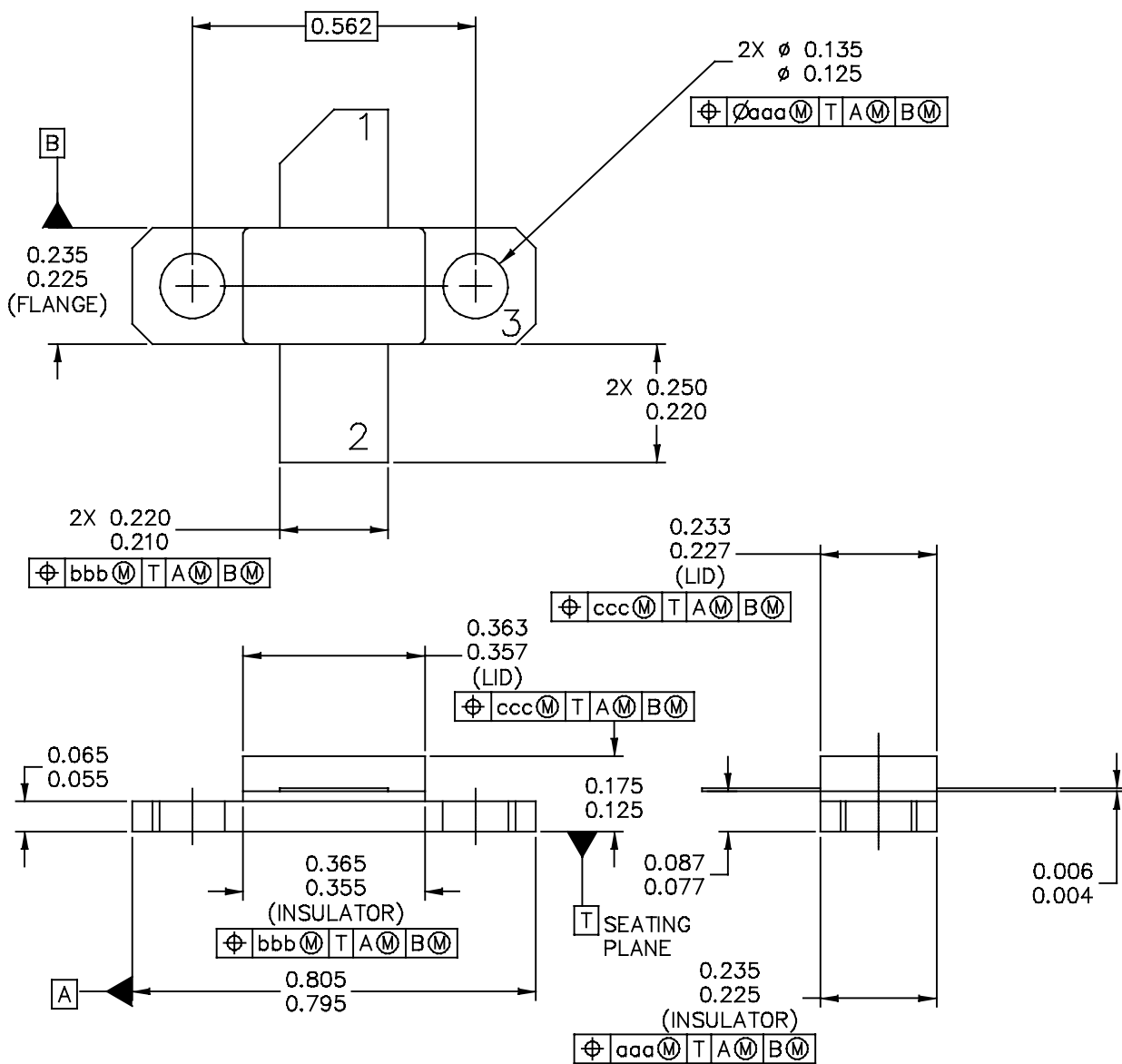

Figure 34. Broadband Series Equivalent Source and Load Impedance — 30-512 MHz

PACKAGE DIMENSIONS



© FREESCALE SEMICONDUCTOR, INC. ALL RIGHTS RESERVED.		MECHANICAL OUTLINE		PRINT VERSION NOT TO SCALE	
TITLE: NI-360		DOCUMENT NO: 98ASB42968B		REV: G	
		CASE NUMBER: 360B-05		05 AUG 2005	
		STANDARD: NON-JEDEC			

NOTES:

1. INTERPRET DIMENSIONS AND TOLERANCES PER ASME Y14.5M-1994.
2. CONTROLLING DIMENSION: INCH
3. DIMENSION H IS MEASURED .030 (0.762) AWAY FROM PACKAGE BODY

STYLE 1:

- PIN 1 - DRAIN
- 2 - GATE
- 3 - SOURCE

© FREESCALE SEMICONDUCTOR, INC. ALL RIGHTS RESERVED.	MECHANICAL OUTLINE	PRINT VERSION NOT TO SCALE	
TITLE: NI-360	DOCUMENT NO: 98ASB42968B	REV: G	
	CASE NUMBER: 360B-05	05 AUG 2005	
	STANDARD: NON-JEDEC		

PRODUCT DOCUMENTATION, SOFTWARE AND TOOLS

Refer to the following documents, software and tools to aid your design process.

Application Notes

- AN1955: Thermal Measurement Methodology of RF Power Amplifiers

Engineering Bulletins

- EB212: Using Data Sheet Impedances for RF LDMOS Devices

Software

- Electromigration MTTF Calculator
- RF High Power Model
- .s2p File

Development Tools

- Printed Circuit Boards

For Software and Tools, do a Part Number search at <http://www.freescale.com>, and select the “Part Number” link. Go to the Software & Tools tab on the part’s Product Summary page to download the respective tool.

REVISION HISTORY

The following table summarizes revisions to this document.

Revision	Date	Description
0	Oct. 2012	• Initial Release of Data Sheet

How to Reach Us:

Home Page:
freescale.com

Web Support:
freescale.com/support

Information in this document is provided solely to enable system and software implementers to use Freescale products. There are no express or implied copyright licenses granted hereunder to design or fabricate any integrated circuits based on the information in this document.

Freescale reserves the right to make changes without further notice to any products herein. Freescale makes no warranty, representation, or guarantee regarding the suitability of its products for any particular purpose, nor does Freescale assume any liability arising out of the application or use of any product or circuit, and specifically disclaims any and all liability, including without limitation consequential or incidental damages. "Typical" parameters that may be provided in Freescale data sheets and/or specifications can and do vary in different applications, and actual performance may vary over time. All operating parameters, including "typicals," must be validated for each customer application by customer's technical experts. Freescale does not convey any license under its patent rights nor the rights of others. Freescale sells products pursuant to standard terms and conditions of sale, which can be found at the following address: freescale.com/SalesTermsandConditions.

Freescale, the Freescale logo, Altivec, C-5, CodeTest, CodeWarrior, ColdFire, C-Ware, Energy Efficient Solutions logo, Kinetis, mobileGT, PowerQUICC, Processor Expert, QorIQ, Qorivva, StarCore, Symphony, and VortiQa are trademarks of Freescale Semiconductor, Inc., Reg. U.S. Pat. & Tm. Off. Airfast, BeeKit, BeeStack, ColdFire+, CoreNet, Flexis, MagniV, MXC, Platform in a Package, QorIQ Qonverge, QUICC Engine, Ready Play, SafeAssure, SMARTMOS, TurboLink, Vybrid, and Xtrinsic are trademarks of Freescale Semiconductor, Inc. All other product or service names are the property of their respective owners.

© 2012 Freescale Semiconductor, Inc.