

SPA Capacitors

Solid Polymer Aluminum Surface Mount Capacitors

*New!
Extended
Range Ratings,
20% More
Capacitance*

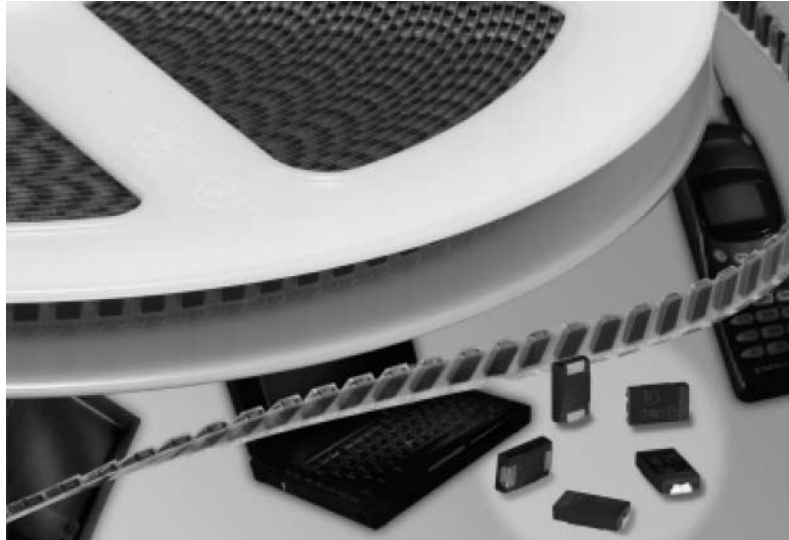

Highlights

- **Capacitance Range: 2.2 μ F to 390 μ F**
- **Ripple current ratings up to 3.5Arms at 100 kHz and 105°C**
- **Low Impedance**
- **Ultra-Low E.S.R.; 10 m Ω @ 100 kHz**
- **-55° to 105°C operating temperature**
- **Voltage Range: 2.0 Vdc to 16 Vdc**
- **Solid electrolyte for extended life**
- **Footprint Compatible with “D” and “E” Case Tantalum**
- **Flat Z and E.S.R. vs. temperature**
- **Ignition free**

Filtering power of 3 or more tantalum chips and 50 year life —

Solid polymer aluminum capacitors combine the high capacitance capability of an electrolytic component with the high frequency performance of film capacitors. When the need for low impedance at high frequency is critical for your design, one SPA chip is capable of replacing several liquid electrolyte aluminum or tantalum capacitors connected in parallel. This is due to the ultra-low e.s.r. which results in significantly lower impedance than either aluminum or tantalum capacitors at frequencies of 100 kHz and above. There is no longer a need to stack capacitors to lower the impedance at high frequency. The low e.s.r. and high

capacitance make them ideal for bypassing high frequency noise, and for switching frequency filtering in DC/DC conversion. SPA capacitors are packaged in a molded resin case with the same footprint (7.3x4.3 mm) as the industry standard tantalum “D” and “E” case sizes. The solid electrolyte results in a capacitor with stable impedance and equivalent series resistance over the entire operating temperature range and they have more than twice the ripple current handling capability of tantalum capacitors. In addition, the solid electrolyte delivers a typical expected operating life of more than 50 years, and it is ignition free.

CDE SPA Type	ESRE	ESRD	ESRD	ESRL	ESRH*
Dimensions (mm)	7.3x4.3x4.1	7.3x4.3x2.8	7.3x4.3x1.8	7.3x4.3x1.1	7.3x4.3x2.8 & 4.1
Capacitance Range (μ F)	100-390	68-270	2.2-120	15-58	68-270
Max. ESR at 100 kHz (Ω)	0.015	0.018	.025 - .110	.035 - .040	.015 - .018
Max. Ripple Current at 100 kHz (Arms)	3.5	3.3	1.0 - 2.7	1.4 - 1.6	2.0 - 3.0

*Operates to 125°C

SPA Capacitors

Solid Polymer Aluminum Capacitors

Applications

Motherboard By-Pass

Switching Supply Input/Output Filters

Power Supply Decoupling

High Frequency Noise Reduction

Laptop LCD Displays

Automotive Digital Equipment

Portable Electronic Equipment

Markings

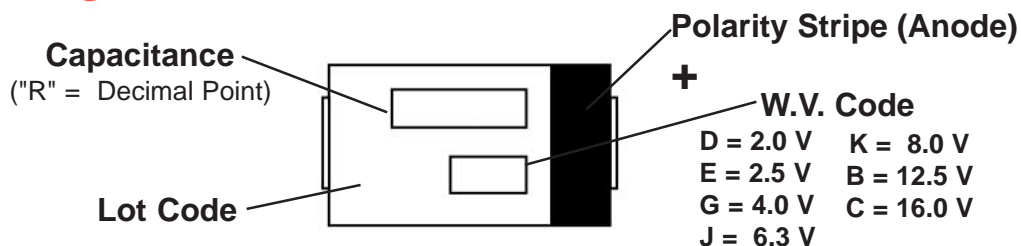

Ordering Information

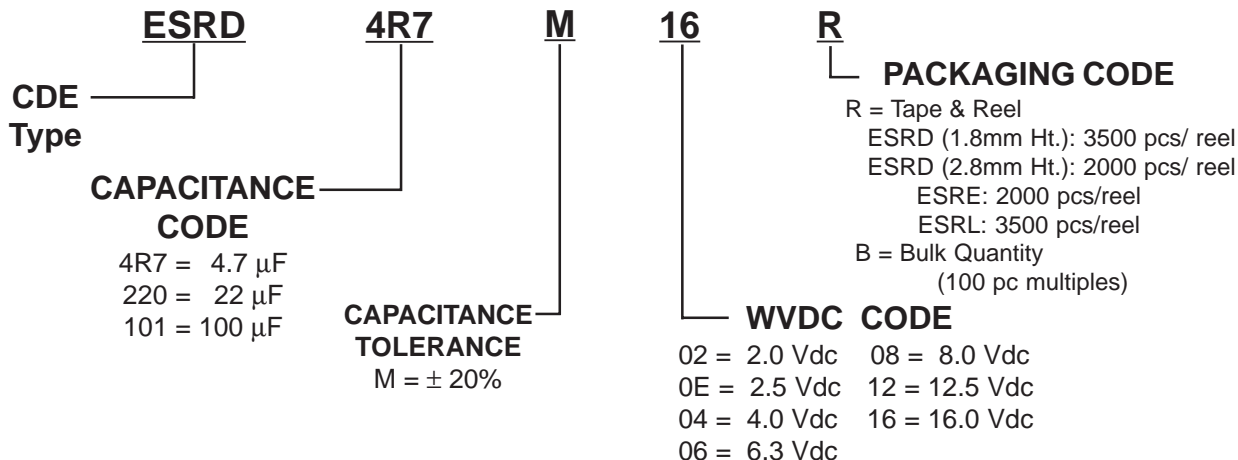

ESRD Surface Mount

Outline Drawing

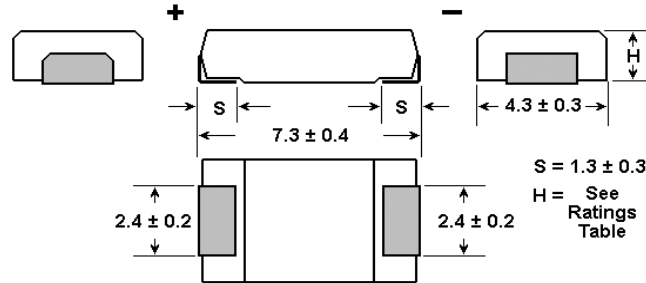

Dimensions in mm

Ratings

Capacitance (μF)	Part Number (Tape & Reel)	Maximum E.S.R 100kHz/20°C (Ω)	Maximum ¹ Ripple Current 100kHz/105°C (Amps)	Case Height H (mm)
2.0 Vdc				
100	ESRD101M02R	0.025	1.8	$1.8 \pm .1$
120	ESRD121M02XR	0.015	2.7	$1.8 \pm .1$
180	ESRD181M02R	0.018	2.2	$2.8 \pm .2$
220	ESRD221M02R	0.018	2.2	$2.8 \pm .2$
270	ESRD271M02XR	0.012	3.3	$2.8 \pm .2$
2.5 Vdc				
82	ESRD820M0ER	0.025	1.8	$1.8 \pm .1$
100	ESRD101M0EXR	0.015	2.7	$1.8 \pm .1$
150	ESRD151M0ER	0.018	2.2	$2.8 \pm .2$
180	ESRD181M0ER	0.018	2.2	$2.8 \pm .2$
220	ESRD221M0EXR	0.012	3.3	$2.8 \pm .2$
4.0 Vdc				
56	ESRD560M04R	0.025	1.8	$1.8 \pm .1$
82	ESRD820M04XR	0.015	2.7	$1.8 \pm .1$
120	ESRD121M04R	0.018	2.2	$2.8 \pm .2$
150	ESRD151M04XR	0.012	3.3	$2.8 \pm .2$
6.3 Vdc				
10	ESRD100M06R	0.060	1.0	$1.8 \pm .1$
22	ESRD220M06R	0.045	1.3	$1.8 \pm .1$
33	ESRD330M06R	0.035	1.6	$1.8 \pm .1$
47	ESRD470M06R	0.025	1.8	$1.8 \pm .1$
68	ESRD680M06XR	0.015	2.7	$1.8 \pm .1$
100	ESRD101M06R	0.018	2.2	$2.8 \pm .2$
120	ESRD121M06XR	0.012	3.3	$2.8 \pm .2$
8.0 Vdc				
8.2	ESRD8R2M08R	0.060	1.0	$1.8 \pm .1$
15	ESRD150M08R	0.045	1.3	$1.8 \pm .1$
22	ESRD220M08R	0.035	1.6	$1.8 \pm .1$
33	ESRD330M08R	0.025	1.8	$1.8 \pm .1$
68	ESRD680M08R	0.018	2.2	$2.8 \pm .2$
12.5 Vdc				
4.7	ESRD4R7M12R	0.080	1.0	$1.8 \pm .1$
10	ESRD100M12R	0.060	1.0	$1.8 \pm .1$
15	ESRD150M12R	0.050	1.3	$1.8 \pm .1$
22	ESRD220M12R	0.040	1.3	$1.8 \pm .1$
16.0 Vdc				
2.2	ESRD2R2M16R	0.110	1.0	$1.8 \pm .1$
4.7	ESRD4R7M16R	0.080	1.0	$1.8 \pm .1$
6.8	ESRD6R8M16R	0.070	1.0	$1.8 \pm .1$
8.2	ESRD8R2M16R	0.060	1.0	$1.8 \pm .1$

¹ For other frequencies use the ripple current frequency multipliers.

SPA Capacitors

Solid Polymer Aluminum Capacitors

ESRE Surface Mount, High Capacitance

Outline Drawing

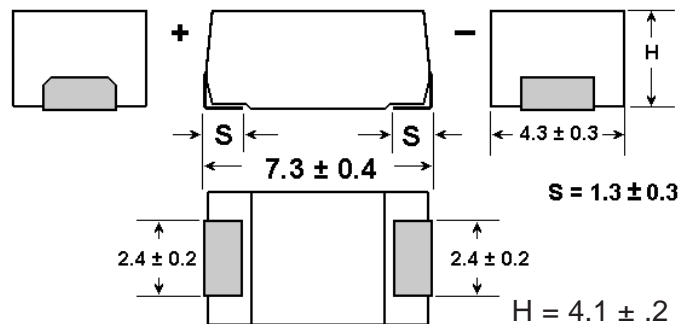

Dimensions in mm

Ratings

Capacitance (μF)	Part Number (Tape & Reel)	Maximum E.S.R 100kHz/20°C (Ω)	Maximum ¹ Ripple Current 100kHz/105°C (Amps)
2.0 Vdc			
270	ESRE271M02R	0.015	3.0
330	ESRE331M02R	0.015	3.0
390	ESRE391M02XR	0.010	3.5
2.5 Vdc			
220	ESRE221M0ER	0.015	3.0
270	ESRE271M0ER	0.015	3.0
330	ESRE331M0EXR	0.010	3.5
4.0 Vdc			
180	ESRE181M04R	0.015	3.0
220	ESRE221M04XR	0.010	3.5
6.3 Vdc			
150	ESRE151M06R	0.015	3.0
180	ESRE181M06XR	0.010	3.5
8.0 Vdc			
100	ESRE101M08R	0.015	3.0

¹ For other frequencies use the ripple current frequency multipliers.

SPA Capacitors

Solid Polymer Aluminum Capacitors

ESRL Surface Mount, Very Low Profile (1.1mm High)

Outline Drawing

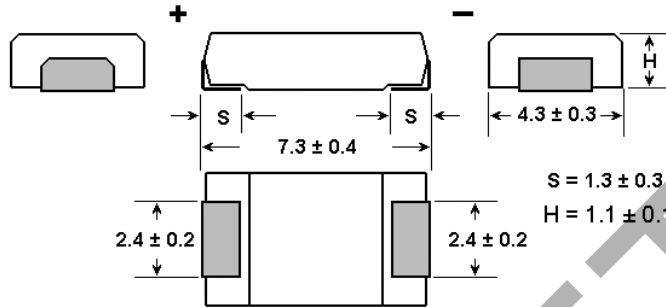

Dimensions in mm

Ratings

Capacitance (μF)	Part Number (Tape & Reel)	Maximum E.S.R 100kHz/20°C (Ω)	Maximum ¹ Ripple Current 100kHz/105°C (Amps)
2.0 Vdc			
68	ESRL680M02R	0.035	1.6
2.5 Vdc			
56	ESRL560M0ER	0.035	1.6
4.0 Vdc			
39	ESRL390M04R	0.035	1.6
47	ESRL470M04R	0.035	1.6
6.3 Vdc			
33	ESRL330M06R	0.035	1.6
8.0 Vdc			
22	ESRL220M08R	0.035	1.6
12.5 Vdc			
15	ESRL150M12R	0.040	1.4

¹ For other frequencies use the ripple current frequency multipliers.

SPA Capacitors

Solid Polymer Aluminum Capacitors

Specifications

Operating Temperature Range;

-55°C to +105°C, at 100% rated voltage

Surge Voltage;

125% of the rated working Vdc

Capacitance Range;

2.2 μ F to 390 μ F

Capacitance Tolerance;

\pm 20% at 120 Hz and +20°C

DC Leakage Current (DCL);

After a two minute application of the rated working voltage at +20°C:

2V - 4V: $I \leq 0.06CV$

6.3V - 16V: $I \leq 0.04CV$ or $3\mu A$
(whichever greater)

Dissipation Factor (DF);

The ratio of the capacitor's equivalent series resistance to its reactance at 120Hz and +20°C.

ESRL & ESRD (1.8 mm ht.): D.F. is .06 Max.

ESRE & ESRD (2.8 mm ht.): D.F. is .10 Max.

Resistance to Soldering Heat;

Heat the capacitors at 235°C in an oven for 200 seconds. The capacitors will meet the following limits after stabilizing at 20°C:

$\Delta C = \pm 10\%$ of the initial measured value

DF \leq the initial specified value

DCL \leq the initial specified value

Vibration;

No abnormal change shall occur to capacitors that have been soldered (and attached) to a board when subjected to a vibration of 1.5 mm amplitude that is varied from 10 Hz to 2000 Hz in 20 min. cycles. The test duration is 2 hours for each right angle direction (total 6 hours). Capacitance is monitored during the last cycle of the test for stability.

Moisture Resistance;

After 500 hours storage at +60°C and 90 to 95% R.H. without load, the capacitor will meet the following limits:

$\Delta C = +70\%/-20\%$ of the initial measured value (2.0 Vdc, 2.5 Vdc),
+60%/-20% of the initial measured value (4.0 Vdc),
+50%/-20% of the initial measured value (6.3 Vdc),
+40%/-20% of the initial measured value (all other voltages)

DF \leq two times the initial specified value

DCL \leq the initial specified value

Life Test;

Apply rated DC working voltage at 105°C for 1000 hours, and then stabilize them to +20°C. Capacitors will meet the following limits:

$\Delta C = \pm 10\%$ of the initial measured value

DF \leq the initial specified value

DCL \leq the initial specified value

Shelf Life Test;

Shelf life is typically 5 to 10 years. Accelerated test: after 500 hours at 105°C, capacitors will meet the following limits after stabilization at 20°C:

$\Delta C = \pm 10\%$ of the initial measured value

DF \leq the initial specified value

DCL \leq the initial specified value

Shear Test;

No damage shall be visible after subjecting a mounted capacitor to a side force of 5 N for 10 seconds