

CoolMOS™ 1) Power MOSFET

Electrically isolated back surface
 2500 V electrical isolation
 N-Channel Enhancement Mode
 Low $R_{DS(on)}$, high V_{DSS} MOSFET
 Ultra low gate charge

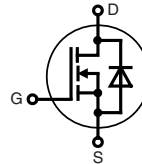
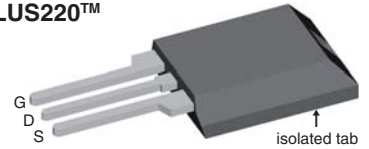

$V_{DSS} = 600\text{ V}$
 $I_{D25} = 28\text{ A}$
 $R_{DS(on) \text{ max}} = 95\text{ m}\Omega$

ISOPLUS220™

E72873

MOSFET			
Symbol	Conditions	Maximum Ratings	
V_{DSS}	$T_{VJ} = 25^\circ\text{C}$	600	V
V_{GS}		± 20	V
I_{D25}	$T_C = 25^\circ\text{C}$	28	A
I_{D90}	$T_C = 90^\circ\text{C}$	19.2	A
E_{AS}	single pulse; $I_D = 10\text{ A}$; $T_C = 25^\circ\text{C}$	690	mJ
E_{AR}	repetitive; $I_D = 20\text{ A}$; $T_C = 25^\circ\text{C}$	1	mJ

Features

- Silicon chip on Direct-Copper-Bond substrate
 - high power dissipation
 - isolated mounting surface
 - 2500 V electrical isolation
 - low drain to tab capacitance ($< 30\text{ pF}$)
- CoolMOS™ 1) power MOSFET
 - 3rd generation
 - high blocking capability
 - lowest resistance
 - avalanche rated for unclamped inductive switching (UIS)
 - low thermal resistance due to reduced chip thickness
- Enhanced total power density

Symbol	Conditions	Characteristic Values			
		$(T_{VJ} = 25^\circ\text{C}, \text{ unless otherwise specified})$			
		min.	typ.	max.	
$R_{DS(on)}$	$V_{GS} = 10\text{ V}$; $I_D = 28\text{ A}$		80	95	m Ω
$V_{GS(th)}$	$V_{DS} = V_{GS}$; $I_D = 2\text{ mA}$	2.1		3.9	V
I_{DSS}	$V_{DS} = 600\text{ V}$; $V_{GS} = 0\text{ V}$			50	μA
				500	μA
I_{GSS}	$V_{GS} = \pm 20\text{ V}$; $V_{DS} = 0\text{ V}$			200	nA
C_{iss}	} $V_{GS} = 0\text{ V}$; $V_{DS} = 25\text{ V}$ $f = 1\text{ MHz}$		4800		pF
C_{oss}				1560	
Q_g	} $V_{GS} = 0\text{ to }10\text{ V}$; $V_{DS} = 350\text{ V}$; $I_D = 40\text{ A}$		175	230	nC
Q_{gs}			22		nC
Q_{gd}			66		nC
$t_{d(on)}$	} $V_{GS} = 13\text{ V}$; $V_{DS} = 380\text{ V}$ $I_D = 40\text{ A}$; $R_G = 1.5\ \Omega$; $T_{VJ} = 125^\circ\text{C}$		10		ns
t_r			5		ns
$t_{d(off)}$			67		ns
t_f			4.5		ns
R_{thJC}				0.6	K/W

Applications

- Switched mode power supplies (SMPS)
- Uninterruptible power supplies (UPS)
- Power factor correction (PFC)
- Welding
- Inductive heating
- PDP and LCD adapter

Advantages

- Easy assembly: no screws or isolation foils required
- Space savings
- High power density
- High reliability

¹⁾ CoolMOS™ is a trademark of Infineon Technologies AG.

Source-Drain Diode

Symbol	Conditions	Characteristic Values			
		min.	typ.	max.	
($T_{VJ} = 25^{\circ}\text{C}$, unless otherwise specified)					
I_S	$V_{GS} = 0\text{ V}$			40	A
V_{SD}	$I_F = 32\text{ A}; V_{GS} = 0\text{ V}$		0.9	1.2	V
t_{rr}	$I_F = 40\text{ A}; -di_F/dt = 200\text{ A}/\mu\text{s}; V_R = 480\text{ V}$		500	800	ns
Q_{RM}			20		μC
I_{RM}			140		A

Component

Symbol	Conditions	Maximum Ratings	
T_{VJ}	operating	-55...+150	$^{\circ}\text{C}$
T_{stg}	storage	-55...+150	$^{\circ}\text{C}$
V_{ISOL}	RMS leads-to-tab, 50/60 Hz, $f = 1$ minute	2500	V~
F_c	mounting force	11-65 / 2.4-11	N/lb

Symbol	Conditions	Characteristic Values		
		min.	typ.	max.
R_{thCH}	with heatsink compound		0.2	K/W
Weight			2.7	g

ISOPLUS220™ Outline

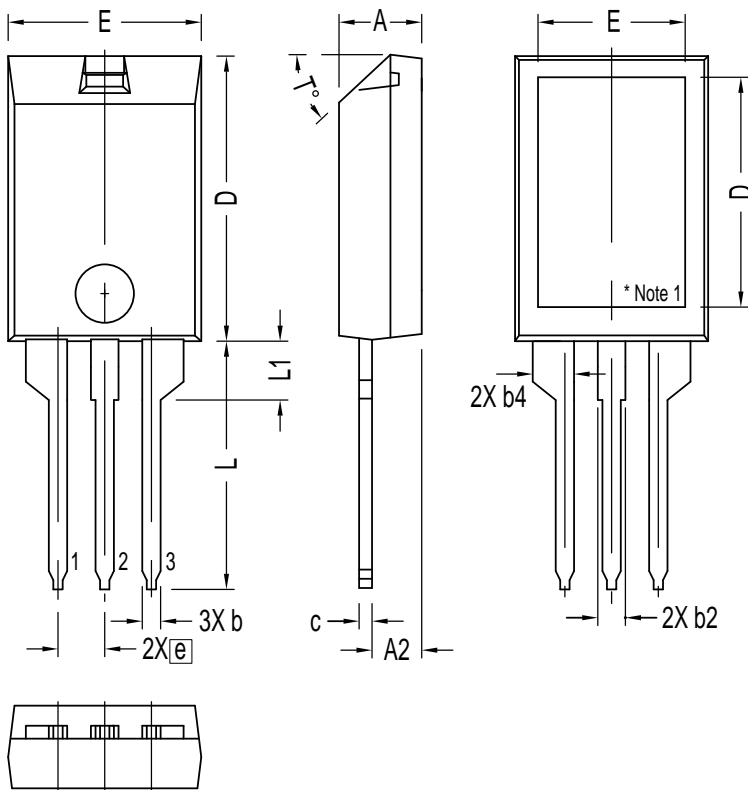

SYM	INCHES		MILLIMETERS	
	MIN	MAX	MIN	MAX
A	.157	.197	4.00	5.00
A2	.098	.118	2.50	3.00
b	.035	.051	0.90	1.30
b2	.049	.065	1.25	1.65
b4	.093	.100	2.35	2.55
c	.028	.039	0.70	1.00
D	.591	.630	15.00	16.00
D1	.472	.512	12.00	13.00
E	.394	.433	10.00	11.00
E1	.295	.335	7.50	8.50
e	.100 BASIC		2.55	BASIC
L	.512	.571	13.00	14.50
L1	.118	.138	3.00	3.50
T°			42.5°	47.5°

NOTE:
 1. Bottom heatsink is electrically isolated from Pin 1, 2, or 3.
 2. This drawing will meet dimensional requirement of JEDEC SS Product Outline TO-273 except D and D1 dimension.

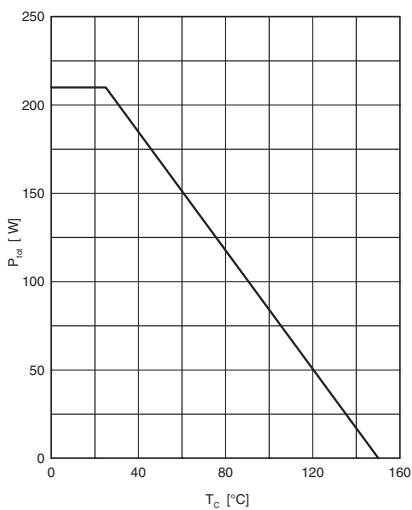

Fig. 1 Power dissipation

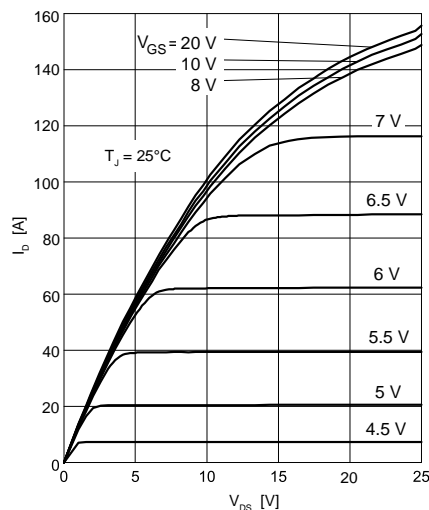

Fig. 2 Typ. output characteristics

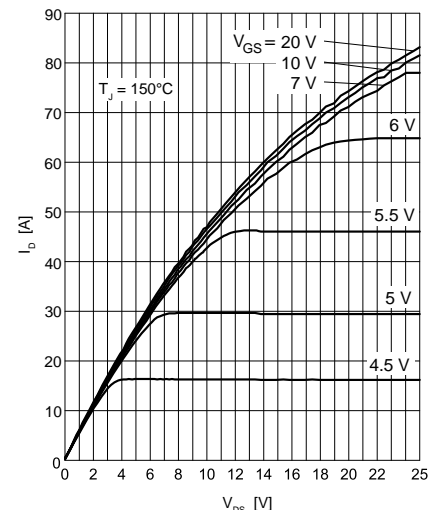

Fig. 3 Typ. output characteristics

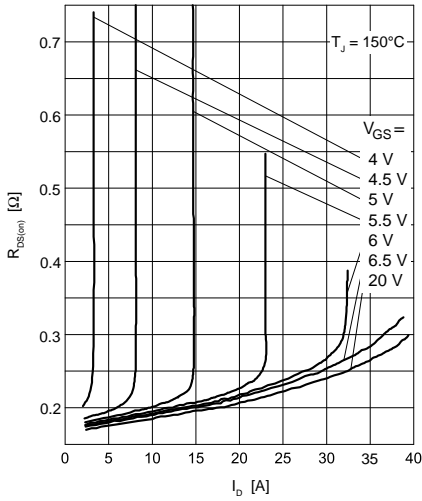

Fig. 4 Typ. drain-source on-state resistance

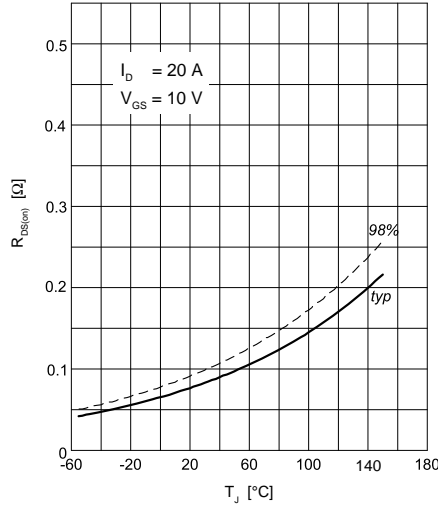

Fig. 5 Drain-source on-state resistance

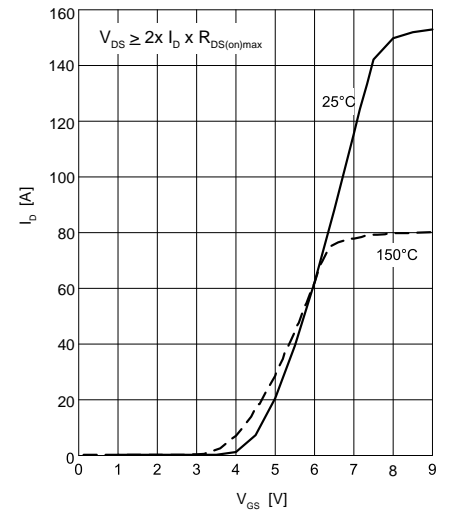

Fig. 6 Typ. transfer characteristics

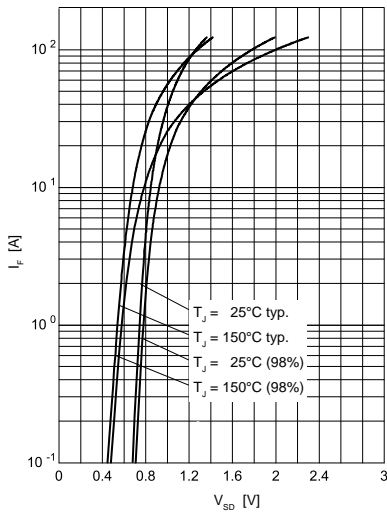

Fig. 7 Forward characteristic of reverse diode

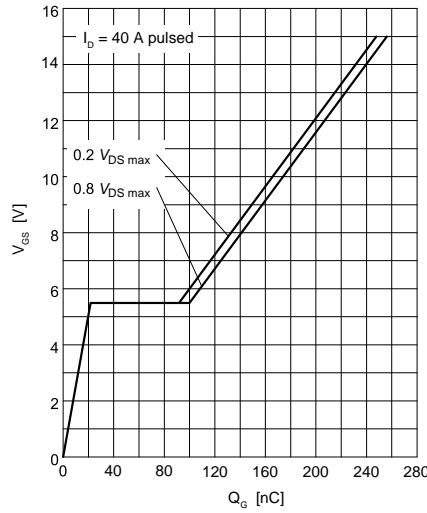

Fig. 8 Typ. gate charge

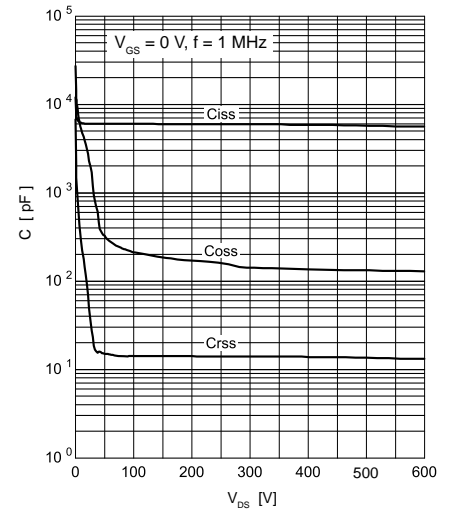

Fig. 9 Typ. capacitances

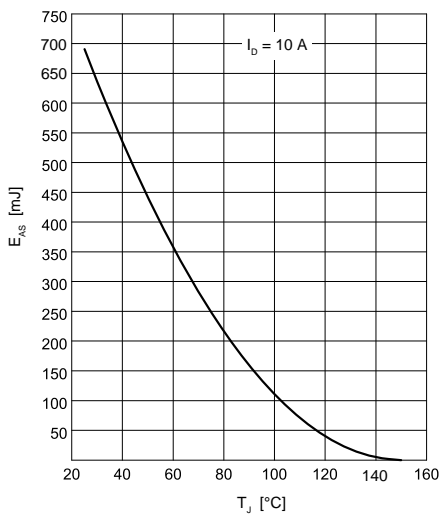

Fig. 10 Avalanche energy

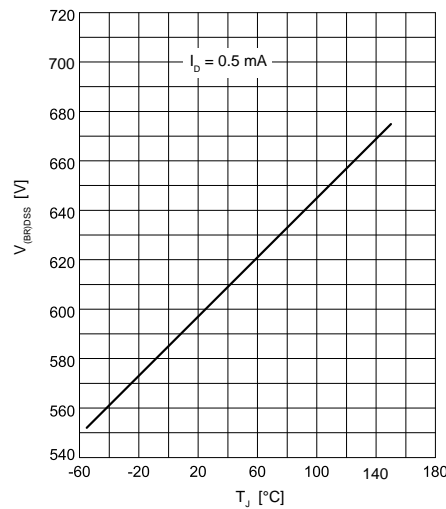

Fig. 11 Drain-source breakdown voltage