

### PROTECTION PRODUCTS - RailClamp®

#### Description

RailClamp is an ultra low capacitance Transient Voltage Suppressor (TVS) designed to protect high speed data interfaces. This device has been specifically designed to protect sensitive components which are connected to high-speed data and transmission lines from over-voltage caused by **ESD** (electrostatic discharge), **CDE** (Cable Discharge Events), and **EFT** (electrical fast transients).

The RClamp™0531T has a maximum capacitance of only 0.80pF. This allows it to be used on circuits operating in excess of 2.5GHz without signal attenuation. They may be used to meet the ESD immunity requirements of IEC 61000-4-2.

The RClamp0531T is in a 2-pin SLP1006P2T package measuring 1.0 x 0.6 x 0.4mm. The leads are spaced at a pitch of 0.65mm and feature a lead-free finish. Each device will protect one high-speed line operating at 5 volts. It gives the designer the flexibility to protect single lines in applications where arrays are not practical. The combination of small size, low capacitance, and high ESD surge capability makes them ideal for use in applications such as cellular phones and digital video interfaces.

#### Features

- ◆ Transient protection for data lines to **IEC 61000-4-2 (ESD) ±20kV (air), ±12kV (contact) IEC 61000-4-4 (EFT) 40A (tp = 5/50ns) Cable Discharge Event (CDE)**
- ◆ Ultra-small package (1.0 x 0.6 x 0.4mm)
- ◆ Protects one I/O line
- ◆ Low capacitance: **0.8pF**
- ◆ Low clamping voltage
- ◆ Low operating voltage: 5.0V
- ◆ Solid-state silicon-avalanche technology

#### Mechanical Characteristics

- ◆ SLP1006P2T package
- ◆ Molding compound flammability rating: UL 94V-0
- ◆ Marking: Marking code + date code
- ◆ Packaging : Tape and Reel
- ◆ Lead Finish: NiPdAu
- ◆ Pb-Free, Halogen Free, RoHS/WEEE Compliant

#### Applications

- ◆ Cellular Handsets & Accessories
- ◆ Digital Visual Interface (DVI)
- ◆ FM Antenna
- ◆ MDDI Ports
- ◆ USB Ports
- ◆ PCI Express
- ◆ Serial ATA

#### Dimensions

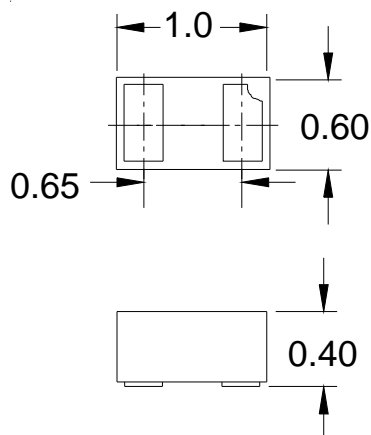

#### Schematic & PIN Configuration

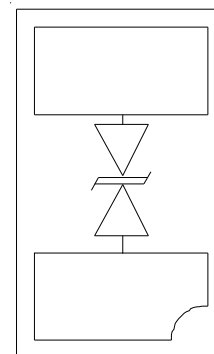

**SLP1006P2T (Bottom View)**

**PROTECTION PRODUCTS**
**Absolute Maximum Rating**

Rating	Symbol	Value	Units
Peak Pulse Power (tp = 8/20μs)	$P_{pk}$	80	Watts
Peak Pulse Current (tp = 8/20μs)	$I_{pp}$	4	A
ESD per IEC 61000-4-2 (Air) ESD per IEC 61000-4-2 (Contact)	$V_{ESD}$	+/- 20 +/- 12	kV
Operating Temperature	$T_J$	-55 to +125	°C
Storage Temperature	$T_{STG}$	-55 to +150	°C

**Electrical Characteristics (T=25°C)**

Parameter	Symbol	Conditions	Minimum	Typical	Maximum	Units
Reverse Stand-Off Voltage	$V_{RWM}$				5	V
Reverse Breakdown Voltage	$V_{BR}$	$I_t = 1mA$	6	9.3	11	V
Reverse Leakage Current	$I_R$	$V_{RWM} = 5V, T=25^\circ C$		0.010	0.100	μA
Clamping Voltage	$V_C$	$I_{pp} = 1A, tp = 8/20\mu s$			12	V
Clamping Voltage	$V_C$	$I_{pp} = 4A, tp = 8/20\mu s$			20	V
Junction Capacitance	$C_j$	$V_R = 0V, f = 1MHz$		0.50	0.80	pF

## PROTECTION PRODUCTS

### Typical Characteristics

#### Non-Repetitive Peak Pulse Power vs. Pulse Time

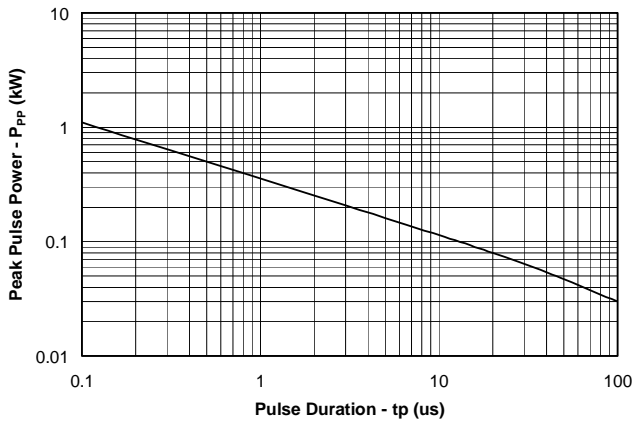

#### Power Derating Curve

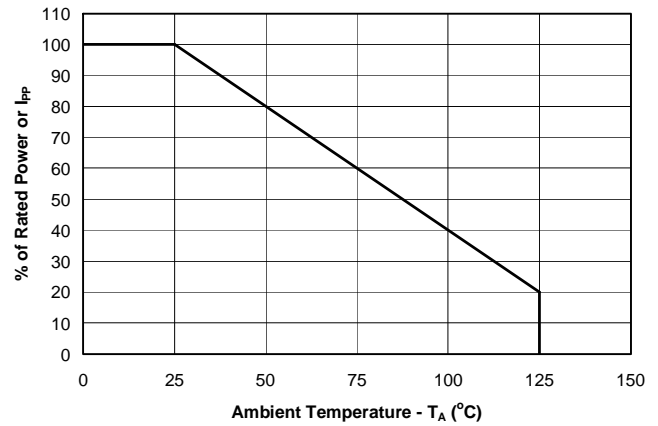

#### Clamping Voltage vs. Peak Pulse Current

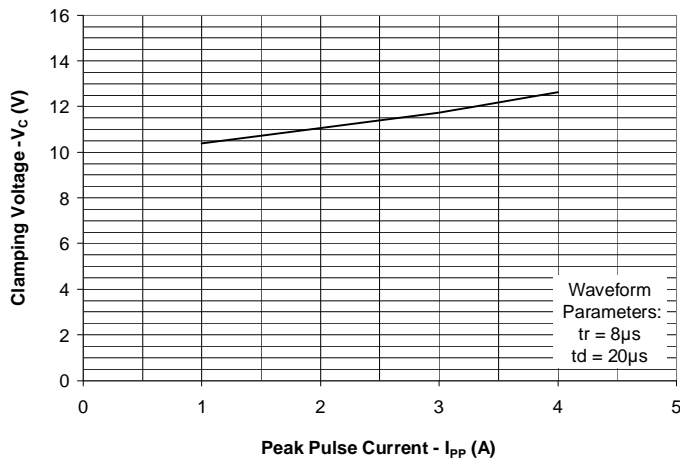

#### Normalized Capacitance vs. Reverse Voltage

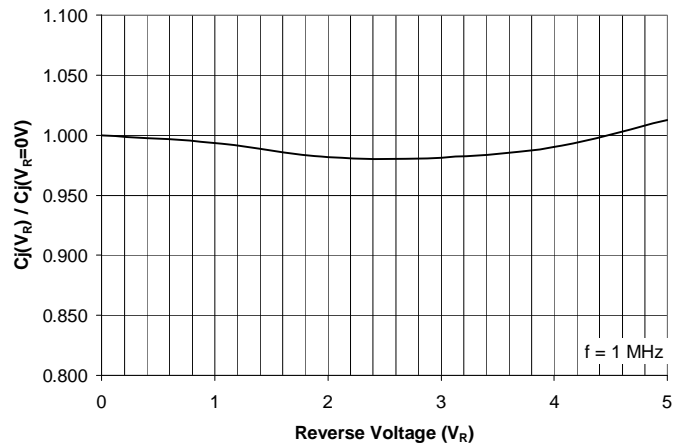

#### Insertion Loss S21

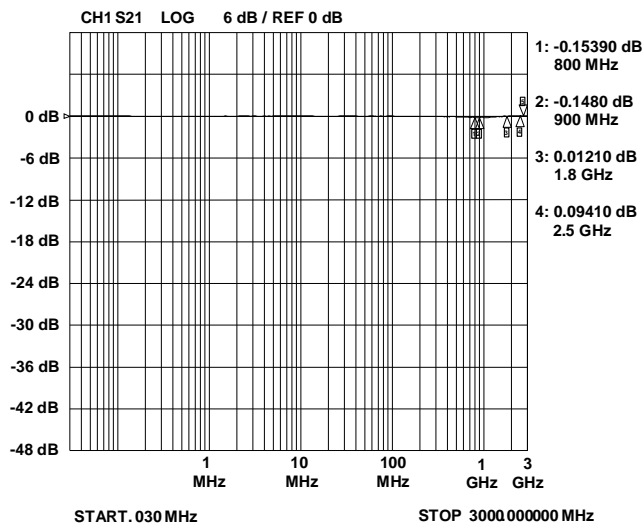

#### USB 2.0 Eye Pattern with RClamp0531T

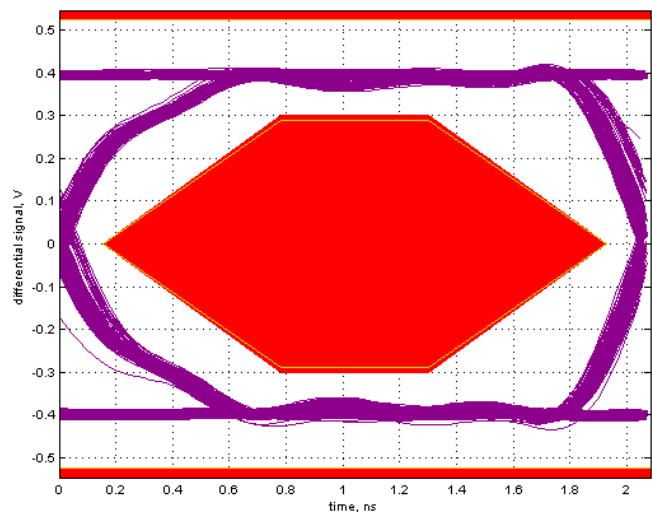

**PROTECTION PRODUCTS**

**ESD Clamping**  
 (+8kV Contact per IEC 61000-4-2)

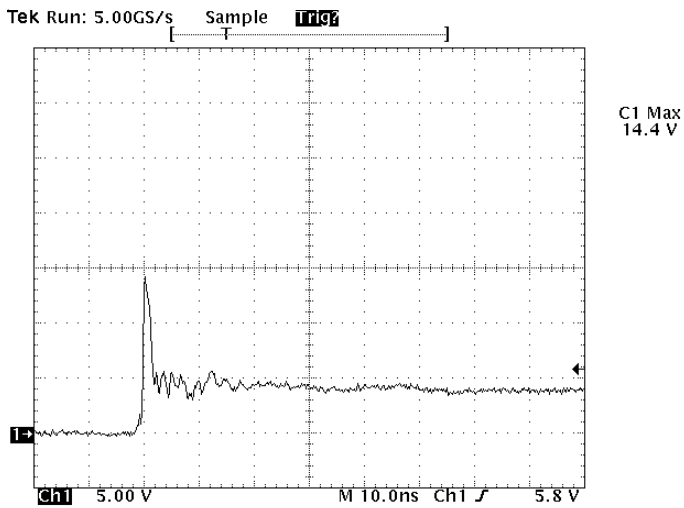

Note: Data is taken with a 10x attenuator

**ESD Clamping**  
 (-8kV Contact per IEC 61000-4-2)

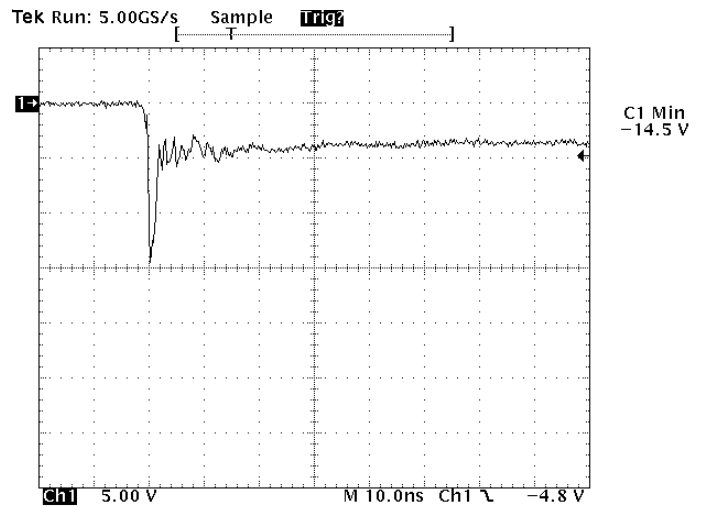

Note: Data is taken with a 10x attenuator

**PROTECTION PRODUCTS****Applications Information****Device Connection Options**

These low capacitance TVS diodes are designed to provide common mode protection for one high-speed line or differential protection for one line pair. The device is bidirectional and may be used on lines where the signal polarity is positive and negative.

**Circuit Board Layout Recommendations for Suppression of ESD.**

Good circuit board layout is critical for the suppression of ESD induced transients. The following guidelines are recommended:

- Place the TVS near the input terminals or connectors to restrict transient coupling.
- Minimize the path length between the TVS and the protected line.
- Minimize all conductive loops including power and ground loops.
- The ESD transient return path to ground should be kept as short as possible.
- Never run critical signals near board edges.
- Use ground planes whenever possible.

**Equivalent Circuit Diagram**

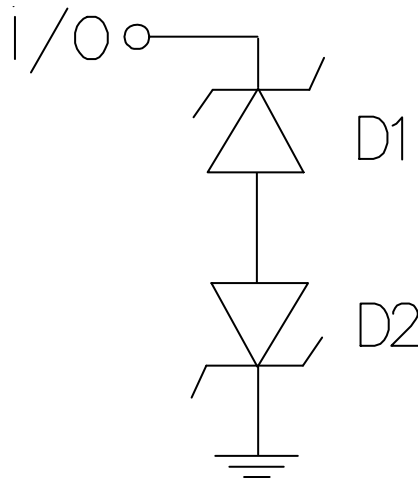
**PROTECTION PRODUCTS**
**Applications Information - Spice Model**

**RClamp0531T Spice Model**

<b>RClamp0531T Spice Parameters</b>			
<b>Parameter</b>	<b>Unit</b>	<b>D1 (TVS)</b>	<b>D2 (TVS)</b>
IS	Amp	2.11E-14	2.11E-14
BV	Volt	8.6	8.6
VJ	Volt	0.7	0.7
RS	Ohm	0.4	0.4
IBV	Amp	1E-3	1E-3
CJO	Farad	0.8E-12	0.8E-12
TT	sec	2.541E-9	2.541E-9
M	--	0.02	0.02
N	--	1.1	1.1
EG	eV	1.11	1.11

Note: Spice model is for simulating transient response only.

PROTECTION PRODUCTS

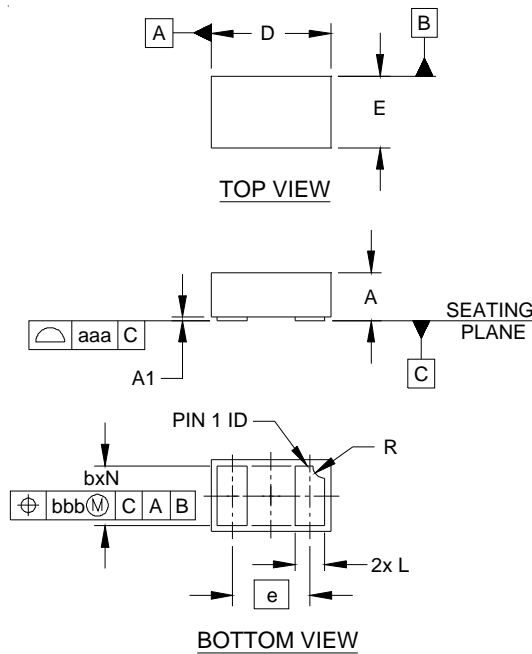
Outline Drawing - SLP1006P2T



DIM	DIMENSIONS					
	INCHES			MILLIMETERS		
	MIN	NOM	MAX	MIN	NOM	MAX
A	.015	.016	.017	0.37	0.40	0.43
A1	.000	.001	.002	0.00	0.03	0.05
b	.018	.020	.022	0.45	0.50	0.55
D	.035	.039	.043	0.90	1.00	1.10
E	.020	.024	.028	0.50	0.60	0.70
e	.026 BSC			0.65 BSC		
L	.008	.010	.012	0.20	0.25	0.30
R	.002	.004	.006	0.05	0.10	0.15
N	2			2		
aaa	.003			0.08		
bbb	.004			0.10		

NOTES:

1. CONTROLLING DIMENSIONS ARE IN MILLIMETERS (ANGLES IN DEGREES).

Land Pattern - SLP1006P2T

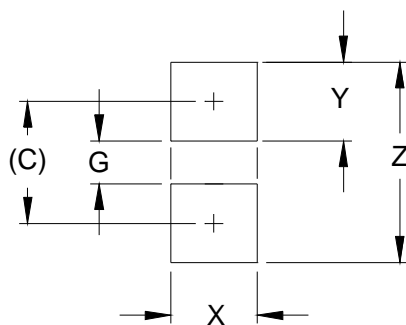

DIM	DIMENSIONS	
	INCHES	MILLIMETERS
C	(.033)	(0.85)
G	.012	0.30
X	.024	0.60
Y	.022	0.55
Z	.055	1.40

NOTES:

1. CONTROLLING DIMENSIONS ARE IN MILLIMETERS (ANGLES IN DEGREES).
2. THIS LAND PATTERN IS FOR REFERENCE PURPOSES ONLY. CONSULT YOUR MANUFACTURING GROUP TO ENSURE YOUR COMPANY'S MANUFACTURING GUIDELINES ARE MET.

## PROTECTION PRODUCTS

### Marking Code

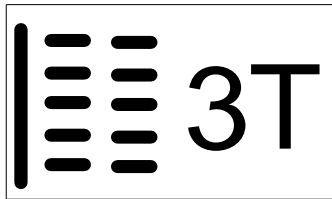

### Ordering Information

Part Number	Working Voltage	Qty per Reel	Reel Size
RClamp0531T.TCT	5V	3,000	7 Inch

RClamp and RClamp are trademarks of Semtech Corporation.

#### Notes:

- 1) Marking will also include line matrix date code
- 2) Device is electrically symmetrical

### Tape and Reel Specification

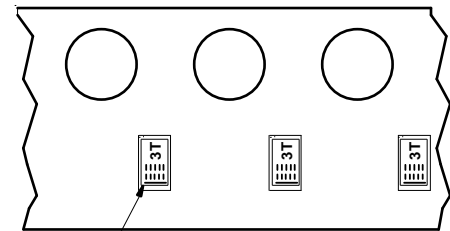
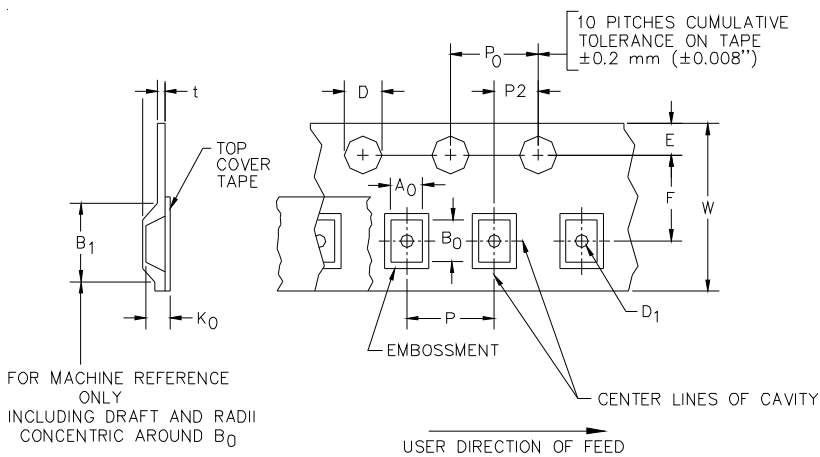

Band Location  
(Opposite Sprocket Holes)

A0	B0	K0
0.69 +/-0.10 mm	1.19 +/-0.10 mm	0.66 +/-0.10 mm

Tape Width	B, (Max)	D	D1	E	F	P	P0	P2	T	W
8 mm	4.2 mm (.165)	1.5 + 0.1 mm - 0.0 mm (0.59 +.005 -.000)	0.4 mm ±0.25 (.031)	1.750±.10 mm (.069±.004)	3.5±0.05 mm (.138±.002)	4.0±0.10 mm (.157±.004)	4.0±0.1 mm (.157±.004)	2.0±0.05 mm (.079±.002)	0.254±0.02 mm (.016)	8.0 mm + 0.3 mm - 0.1 mm (.312±.012)

### Contact Information

Semtech Corporation  
 Protection Products Division  
 200 Flynn Rd., Camarillo, CA 93012  
 Phone: (805)498-2111 FAX (805)498-3804