

PXF40xxWSxx Single Output DC/DC Converter

9 to 36 Vdc and 18 to 75 Vdc input, 3.3 to 15 Vdc Single Output, 40W



Applications

- Wireless Network
- Telecom/Datacom
- Industry Control System
- Measurement Equipment
- Semiconductor Equipment

Features

- Single output current up to 10A
- 40 watts maximum output power
- 4:1 ultra wide input voltage range of 9-36 and 18-75VDC
- Six-sided continuous shield
- Case grounding
- High efficiency up to 88%
- Low profile: 2.00 x 2.00 x 0.40 inch (50.8x50.8x10.2 mm)
- Fixed switching frequency
- RoHS directive compliant
- Input to output isolation: 1600Vdc,min
- Over-temperature protection
- Input under-voltage protection
- Output over-voltage protection
- Over-current protection, auto-recovery
- Output short circuit protection, auto-recovery
- Remote ON/OFF

Options

- Heat sinks available for extended operation
- Remote ON/OFF logic configuration

General Description

The PXF40-xxWSxx single output offers 40 watts of output power from a 2.00 x 2.00 x 0.4 inch package. This series with 4:1 ultra wide input voltage of 9-36VDC and 18-75VDC, features 1600VDC of isolation, short-circuit, over-voltage and over-temperature protection, as well as six sided shielding. All models are particularly suited for telecommunications, industrial, mobile telecom and test equipment applications.

Table of Contents

Absolute Maximum Rating	P2	Heat Sink Consideration	P25
Output Specification	P2	Remote ON/OFF Control	P26
Input Specification	P3	Mechanical Data	P27
General Specification	P4	Recommended Pad Layout	P27
Characteristic Curves	P5	Output Voltage Adjustment	P28
Test Configurations	P21	Remote Sense Application Circuit	P29
EMC Considerations	P22	Soldering Consideration	P29
Input Source Impedance	P24	Packaging Information	P30
Output Over Current Protection	P24	Part Number Structure	P30
Output Over Voltage Protection	P24	Safety and Installation Instruction	P31
Thermal Consideration	P25	MTBF and Reliability	P31

Absolute Maximum Ratings				
Parameter	Model	Min	Max	Unit
Input Voltage	24WSxx 48WSxx		36	V_{DC}
			75	
Transient (100ms)	24WSxx 48WSxx		50	
			100	
Operating Ambient Temperature (with derating)	All	-40	105	°C
Operating Case Temperature	All		105	°C
Storage Temperature	All	-55	125	°C

Output Specifications					
Parameter	Model	Min	Typ	Max	Unit
Output Voltage ($V_{in} = V_{in(nom)}$; Full Load ; $T_A=25^{\circ}C$)	xxWS3P3	3.267	3.3	3.333	V_{DC}
	xxWS05	4.95	5	5.05	
	xxWS12	11.88	12	12.12	
	xxWS15	14.85	15	15.15	
Voltage Adjustability	All	-10		+10	%
Output Regulation Line ($V_{in(min)}$ to $V_{in(max)}$ at Full Load) Load (Min. to 100% of Full Load)	All	-0.2		+0.2	%
		-0.5		+0.5	
Output Ripple & Noise Peak-to-Peak (20MHz bandwidth)	xxWS3P3			50	mVp-p
	xxWS05			50	
	xxWS12			75	
	xxWS15			75	
Temperature Coefficient	All	-0.02		+0.02	%/°C
Output Voltage Overshoot ($V_{in(min)}$ to $V_{in(max)}$; Full Load ; $T_A=25^{\circ}C$)	All			3	% V_{OUT}
Dynamic Load Response ($V_{in} = V_{in(nom)}$; $T_A=25^{\circ}C$) Load step change from 75% to 100% or 100 to 75% of Full Load Peak Deviation Setting Time (V_{OUT} -10% peak deviation)	All		250		mV
	All		250		μS
Output Current	xxWS3P3	0		10000	mA
	xxWS05	0		8000	
	xxWS12	50		3333	
	xxWS15	50		2666	
Output Over Voltage Protection (Zener diode clamp)	xxWS3P3		3.9		V_{DC}
	xxWS05		6.2		
	xxWS12		15		
	xxWS15		18		
Output Over Current Protection	All			150	% FL.
Output Short Circuit Protection	All	Hiccup, automatic recovery			

Input Specification					
Parameter	Model	Min	Typ	Max	Unit
Operating Input Voltage	24WSxx	9	24	36	V _{DC}
	48WSxx	18	48	75	
Input Current (Maximum value at V _{in} = V _{in} (nom); Full Load)	24WS3P3			1677	mA
	24WS05			2008	
	24WS12			2008	
	24WS15			2008	
	48WS3P3			838	
	48WS05			992	
	48WS12			1004	
	48WS15			1004	
Input Standby Current (Typical value at V _{in} = V _{in} (nom); No Load)	24WS3P3		80		mA
	24WS05		100		
	24WS12		50		
	24WS15		50		
	48WS3P3		60		
	48WS05		65		
	48WS12		30		
	48WS15		30		
Under Voltage Lockout Turn-on Threshold	24WSxx			9	V _{DC}
	48WSxx			18	
Under Voltage Lockout Turn-off Threshold	24WSxx		8		V _{DC}
	48WSxx		16		
Input Reflected Ripple Current (5 to 20MHz, 12μH Source Impedance)	All		20		mAp-p
Start Up Time (V _{in} = V _{in} (nom) and Constant Resistive Load)					mS
	Power Up	All		20	
	Remote ON/OFF			20	
Remote ON/OFF Control (The ON/OFF pin voltage is referenced to -V _{IN})	Negative Logic DC-DC ON(Short)	All	0	1.2	V _{DC}
	DC-DC OFF(Open)		3	12	
	Positive Logic DC-DC ON(Open)		3	12	
	DC-DC OFF(Short)		0	1.2	
Remote Off Input Current	24WSxx		10		mA
	48WSxx		5		
Input Current of Remote Control Pin	All	-0.5		0.5	mA

General Specifications					
Parameter	Model	Min	Typ	Max	Unit
Efficiency ($V_{in} = V_{in(nom)}$; Full Load ; $T_A=25^{\circ}C$)	24WS3P3		86		%
	24WS05		87		
	24WS12		87		
	24WS15		87		
	48WS3P3		86		
	48WS05		88		
	48WS12		87		
	48WS15		87		
Isolation Voltage Input to Output Input (Output) to Case	All	1600 1600			V_{DC}
Isolation Resistance	All	1			G Ω
Isolation Capacitance	All			2500	pF
Switching Frequency	All		300		KHz
Weight	All		60		g
MTBF(See Page 31) Bellcore TR-NWT-000332, $T_C=40^{\circ}C$ MIL-HDBK-217F	All		1.105×10^6 1.511×10^5		hours
Over Temperature Protection	All		110		$^{\circ}C$

Characteristic Curves

All test conditions are at 25°C. The figures are for PXF40-24WS3P3.

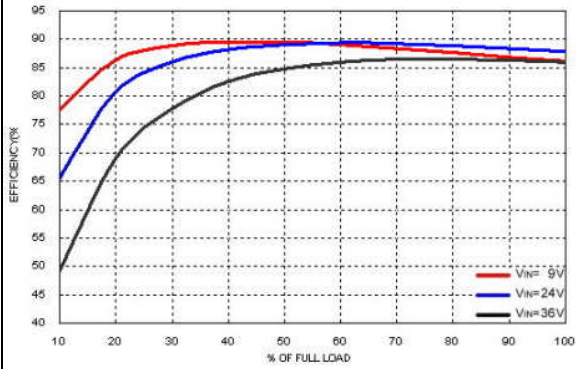

Efficiency Versus Output Current

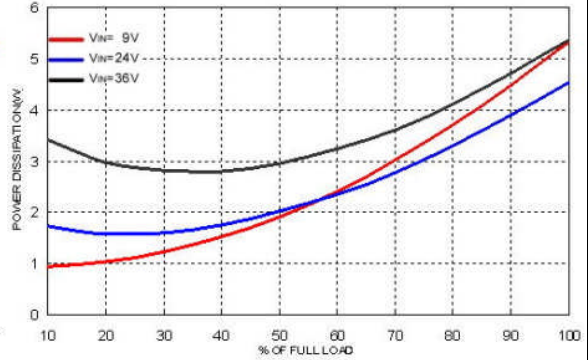

Power Dissipation Versus Output Current

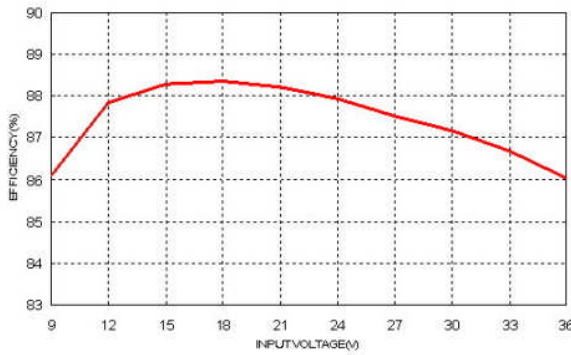

Efficiency Versus Input Voltage. Full Load

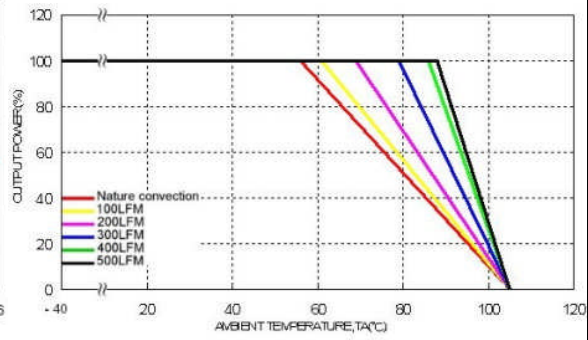

Derating Output Current Versus Ambient Temperature and Airflow
Vin = Vin(nom)

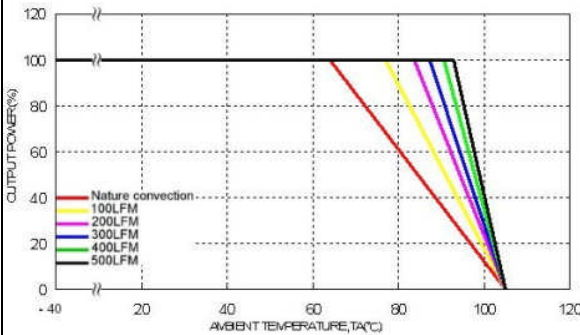

Derating Output Current Versus Ambient Temperature with Heat-Sink
and Airflow, Vin = Vin(nom)

Characteristic Curves (Continued)

All test conditions are at 25°C. The figures are for PXF40-24WS3P3.

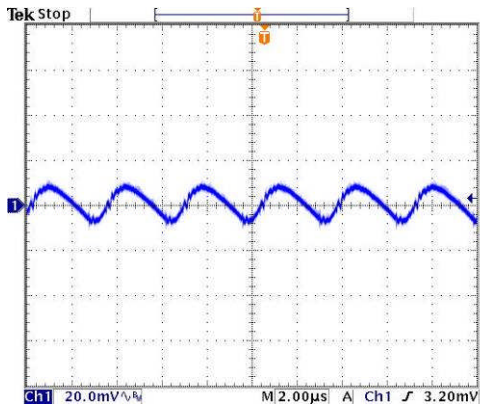

Typical Output Ripple and Noise.
 $V_{in} = V_{in}(nom)$, Full Load

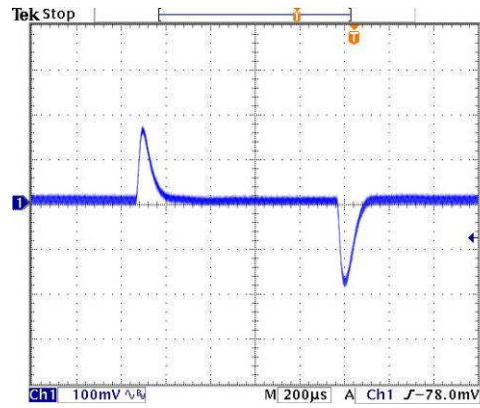

Transient Response to Dynamic Load Change from 100% to 75% to 100% of Full Load ; $V_{in} = V_{in}(nom)$

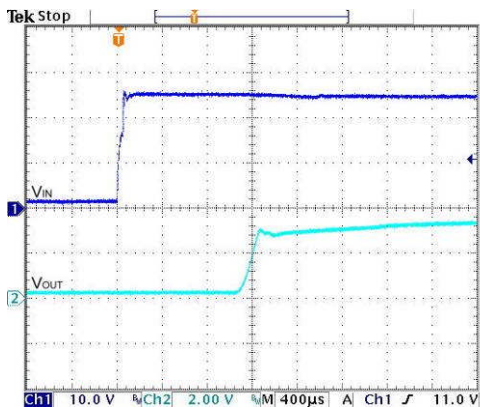

Typical Input Start-Up and Output Rise Characteristic
 $V_{in} = V_{in}(nom)$, Full Load

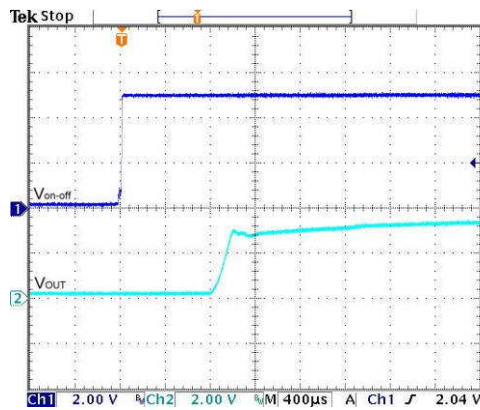

Using ON/OFF Voltage Start-Up and Vo Rise Characteristic
 $V_{in} = V_{in}(nom)$, Full Load

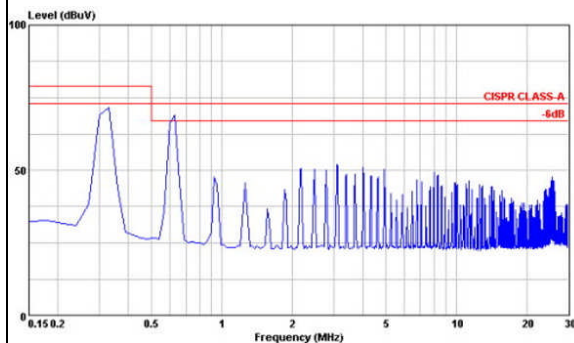

Conduction Emission of EN55022 Class A
 $V_{in} = V_{in}(nom)$, Full Load

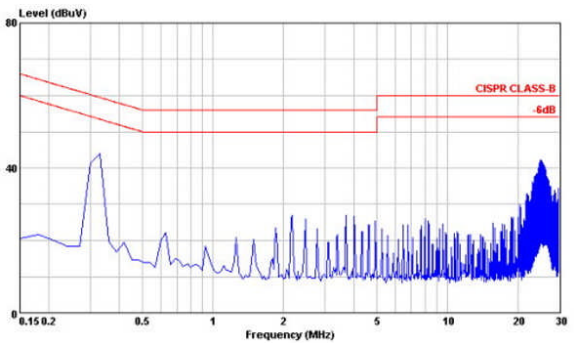

Conduction Emission of EN55022 Class B
 $V_{in} = V_{in}(nom)$, Full Load

Characteristic Curves (Continued)

All test conditions are at 25°C. The figures are for PXF40-24WS05.

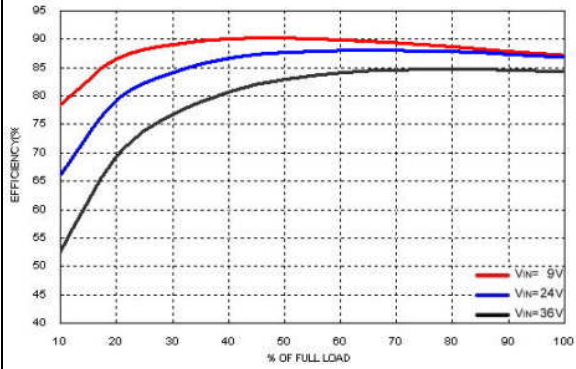

Efficiency Versus Output Current

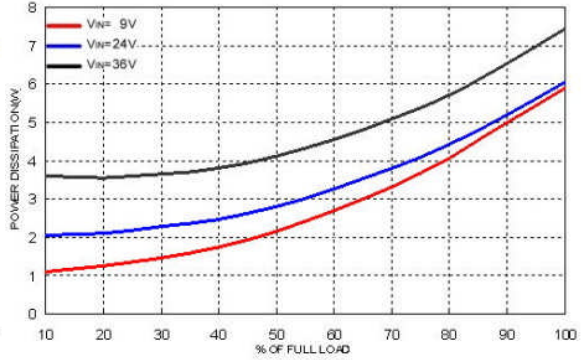

Power Dissipation Versus Output Current

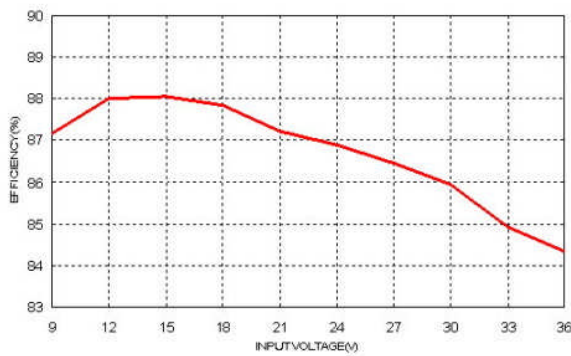

Efficiency Versus Input Voltage. Full Load

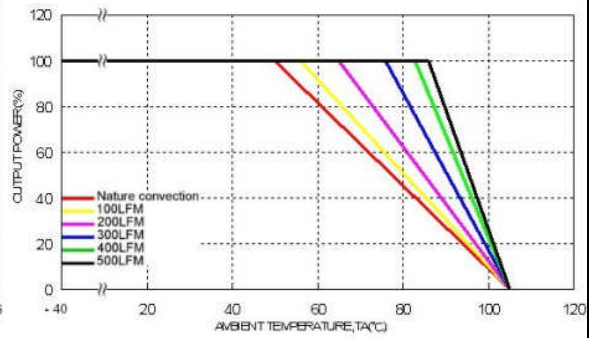

Derating Output Current Versus Ambient Temperature and Airflow
 $V_{in} = V_{in}(nom)$

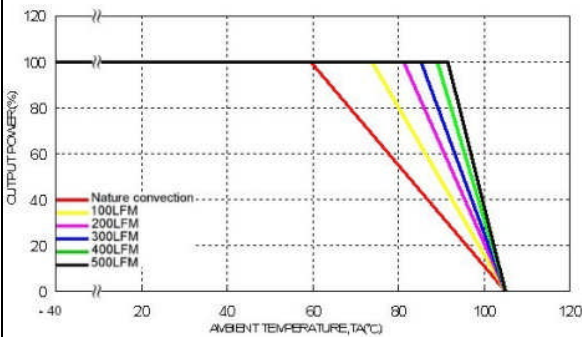

Derating Output Current Versus Ambient Temperature with Heat-Sink
and Airflow, $V_{in} = V_{in}(nom)$

Characteristic Curves (Continued)

All test conditions are at 25°C. The figures are for PXF40-24WS05.

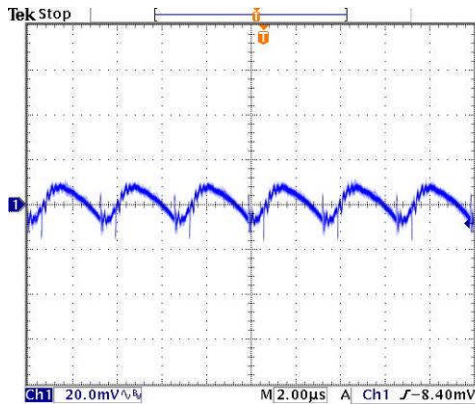

Typical Output Ripple and Noise.
Vin=Vin(nom), Full Load

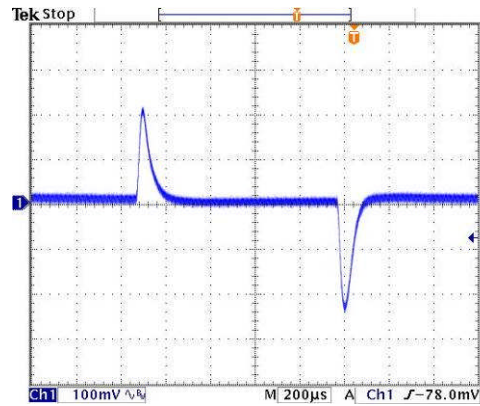

Transient Response to Dynamic Load Change from 100% to 75% to 100% of Full Load ; Vin=Vin(nom)

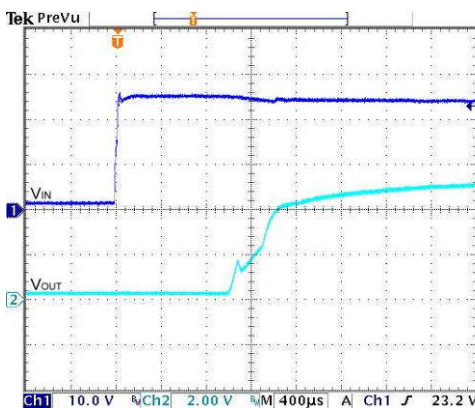

Typical Input Start-Up and Output Rise Characteristic
Vin=Vin(nom), Full Load

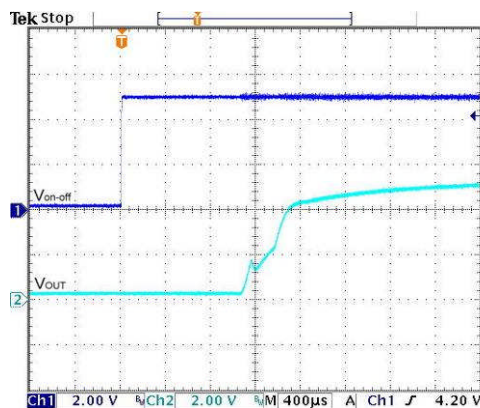

Using ON/OFF Voltage Start-Up and Vo Rise Characteristic
Vin=Vin(nom), Full Load

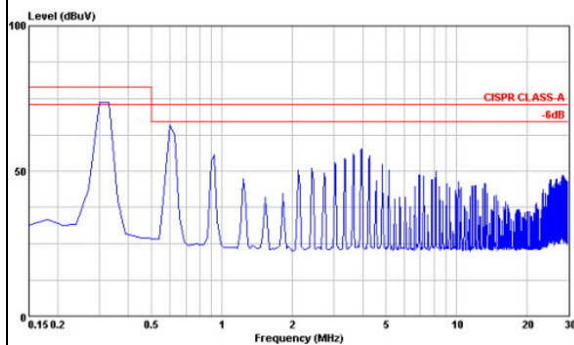

Conduction Emission of EN55022 Class A
Vin=Vin(nom), Full Load

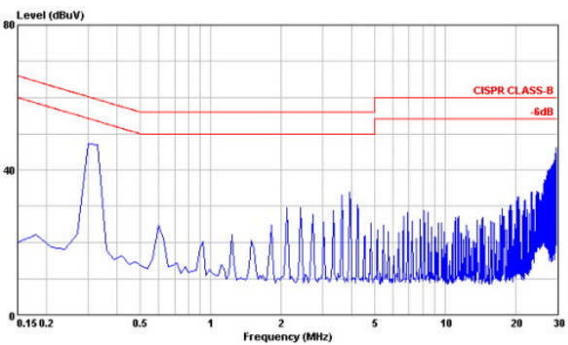

Conduction Emission of EN55022 Class B
Vin=Vin(nom), Full Load

Characteristic Curves (Continued)

All test conditions are at 25°C. The figures are for PXF40-24WS12.

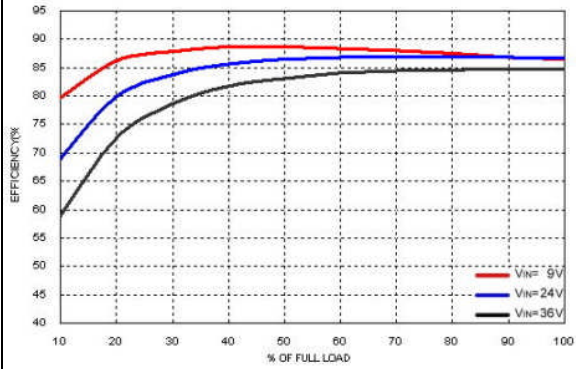

Efficiency Versus Output Current

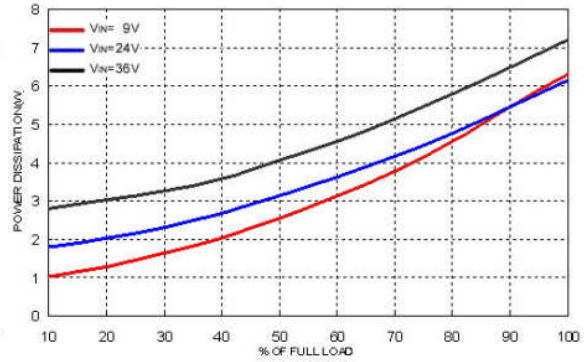

Power Dissipation Versus Output Current

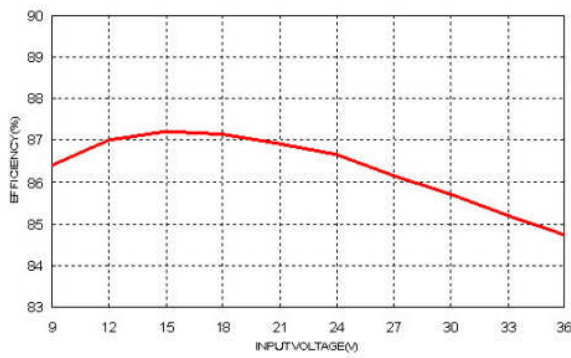

Efficiency Versus Input Voltage. Full Load

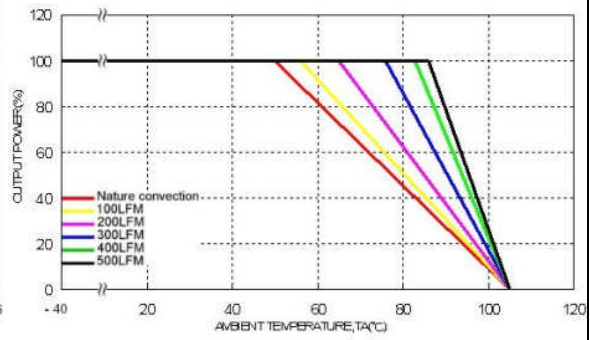

Derating Output Current Versus Ambient Temperature and Airflow
Vin=Vin(nom)

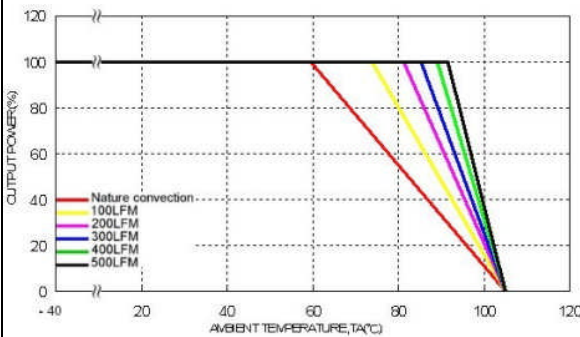

Derating Output Current Versus Ambient Temperature with Heat-Sink
and Airflow, Vin = Vin(nom)

Characteristic Curves (Continued)

All test conditions are at 25°C. The figures are for PXF40-24WS12.

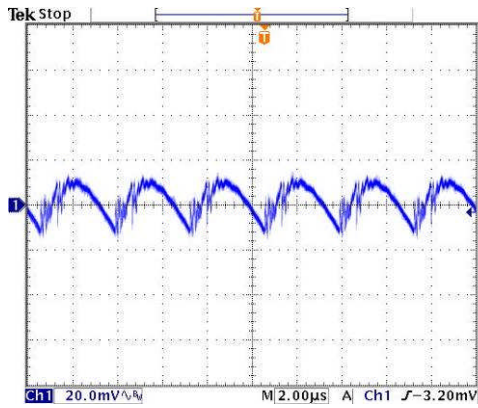

Typical Output Ripple and Noise.
Vin=Vin(nom), Full Load

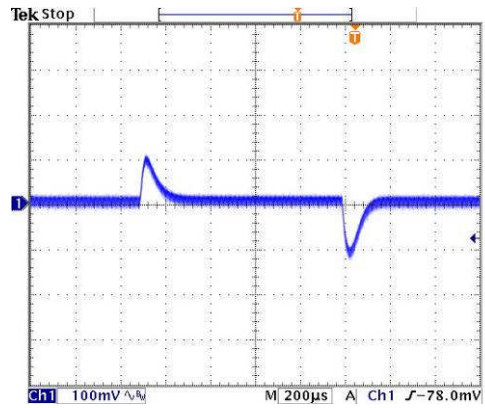

Transient Response to Dynamic Load Change from 100% to 75% to 100% of Full Load ; Vin=Vin(nom)

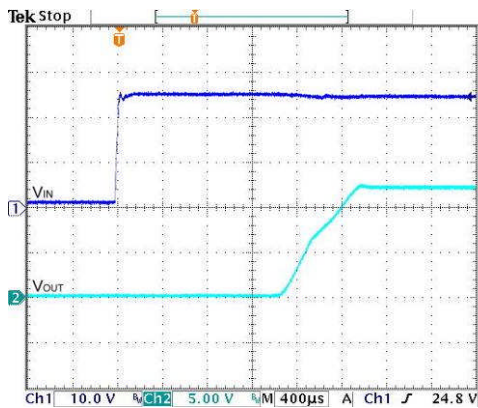

Typical Input Start-Up and Output Rise Characteristic
Vin=Vin(nom), Full Load

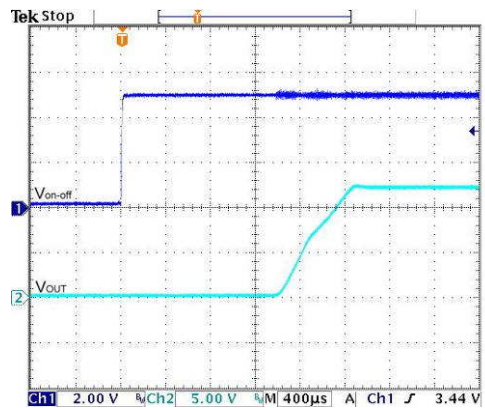

Using ON/OFF Voltage Start-Up and Vo Rise Characteristic
Vin=Vin(nom), Full Load

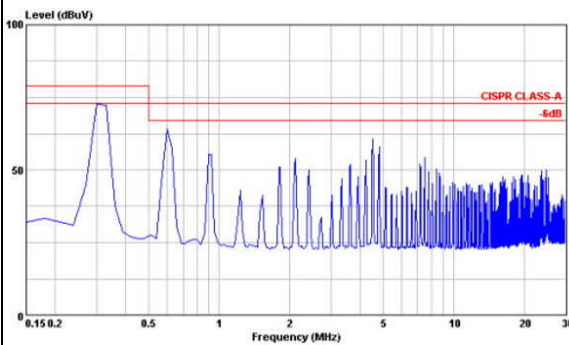

Conduction Emission of EN55022 Class A
Vin=Vin(nom), Full Load

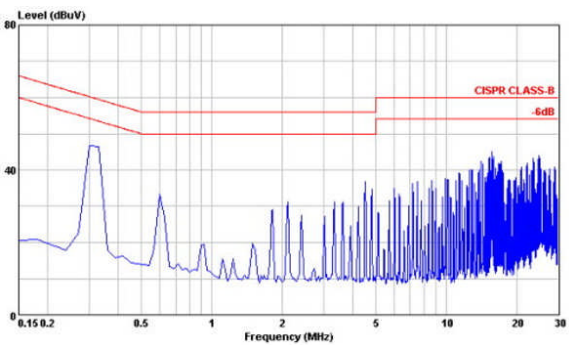

Conduction Emission of EN55022 Class B
Vin=Vin(nom), Full Load

Characteristic Curves (Continued)

All test conditions are at 25°C. The figures are for PXF40-24WS15.

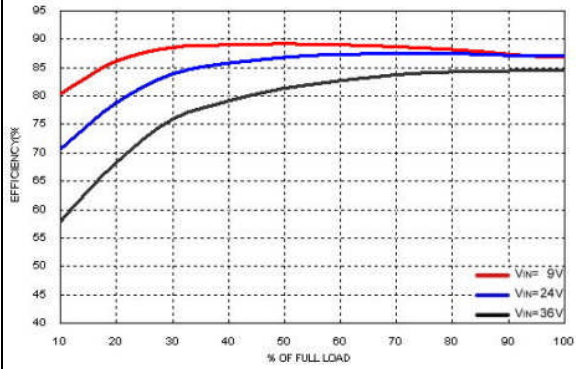

Efficiency Versus Output Current

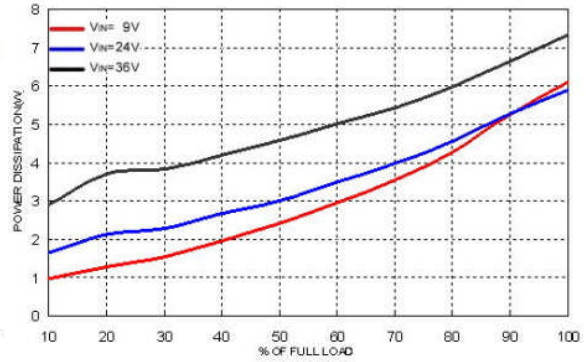

Power Dissipation Versus Output Current

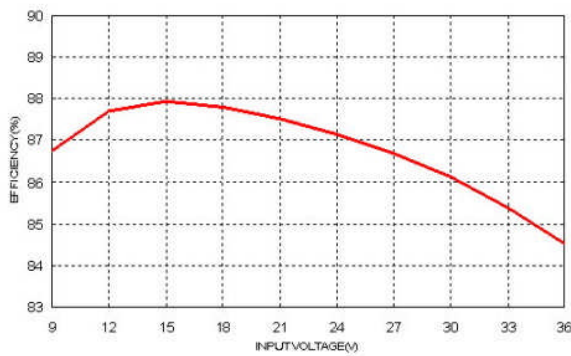

Efficiency Versus Input Voltage. Full Load

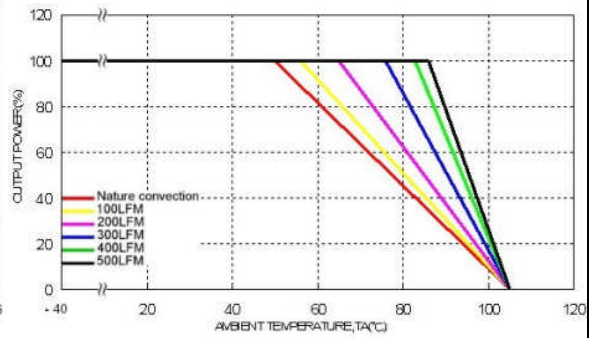

Derating Output Current Versus Ambient Temperature and Airflow
Vin=Vin(nom)

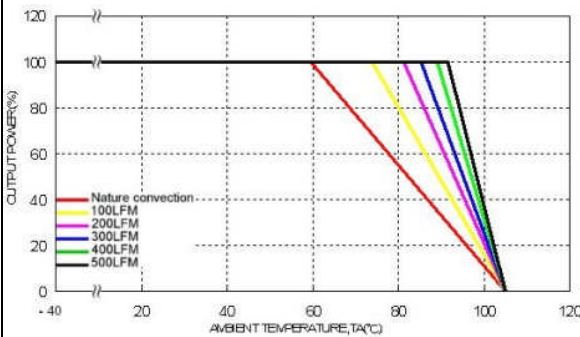

Derating Output Current Versus Ambient Temperature with Heat-Sink
and Airflow, Vin = Vin(nom)

Characteristic Curves (Continued)

All test conditions are at 25°C. The figures are for PXF40-24WS15.

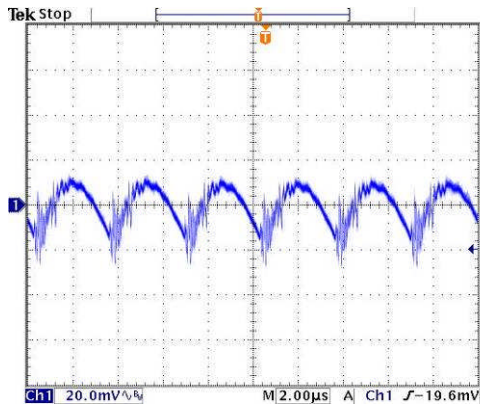

Typical Output Ripple and Noise.
Vin=Vin(nom), Full Load

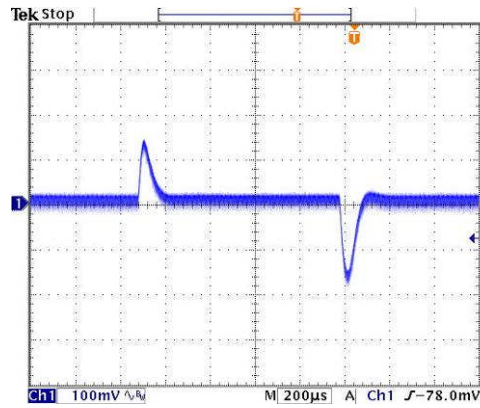

Transient Response to Dynamic Load Change from 100% to 75% to 100% of Full Load ; Vin=Vin(nom)

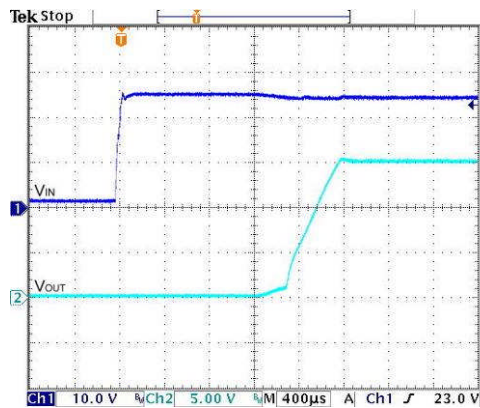

Typical Input Start-Up and Output Rise Characteristic
Vin=Vin(nom), Full Load

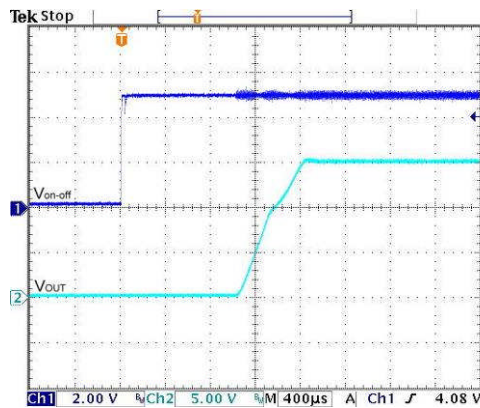

Using ON/OFF Voltage Start-Up and Vo Rise Characteristic
Vin=Vin(nom), Full Load

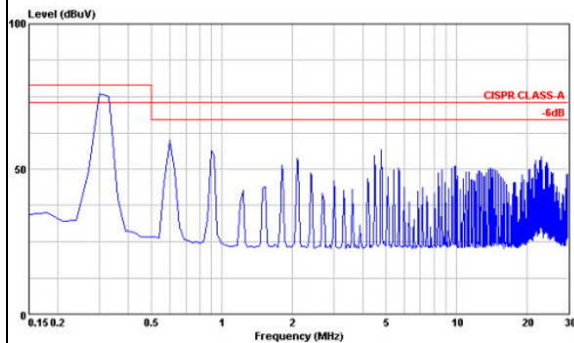

Conduction Emission of EN55022 Class A
Vin=Vin(nom), Full Load

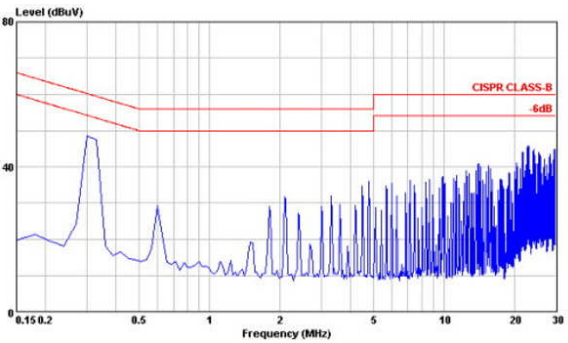

Conduction Emission of EN55022 Class B
Vin=Vin(nom), Full Load

Characteristic Curves (Continued)

All test conditions are at 25C. The figures are for PXF40-48WS3P3

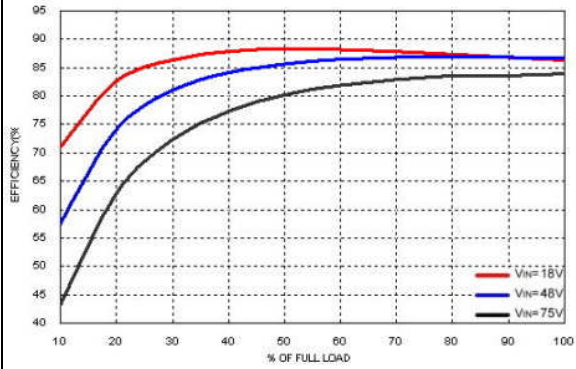

Efficiency Versus Output Current

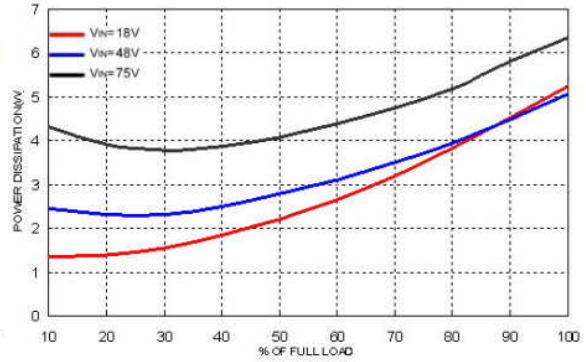

Power Dissipation Versus Output Current

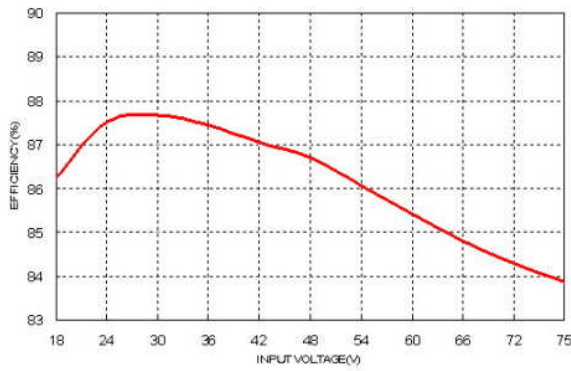

Efficiency Versus Input Voltage. Full Load

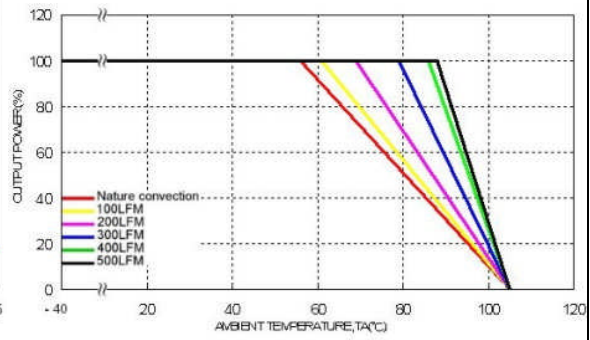

Derating Output Current Versus Ambient Temperature and Airflow
Vin=Vin(nom)

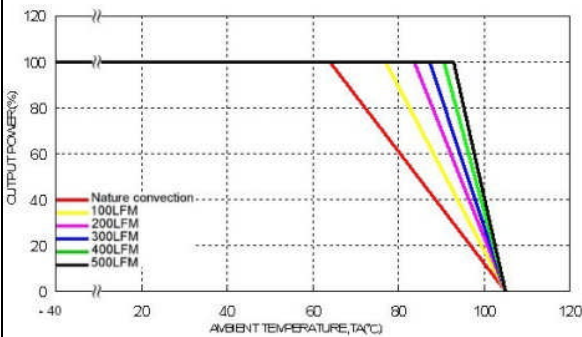

Derating Output Current Versus Ambient Temperature with Heat-Sink
and Airflow, Vin = Vin(nom)

Characteristic Curves (Continued)

All test conditions are at 25°C. The figures are for PXF40-48WS3P3.

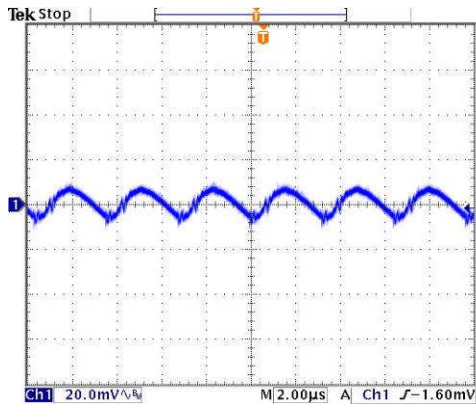

Typical Output Ripple and Noise.
Vin=Vin(nom), Full Load

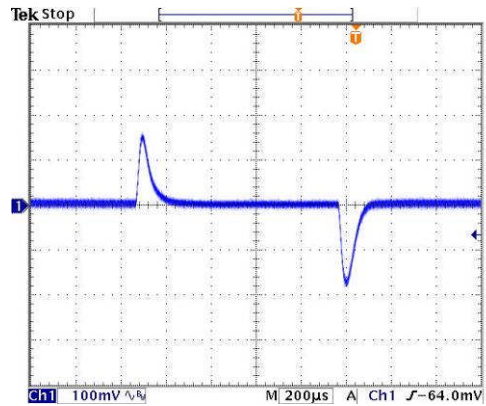

Transient Response to Dynamic Load Change from 100% to 75% to 100% of Full Load ; Vin=Vin(nom)

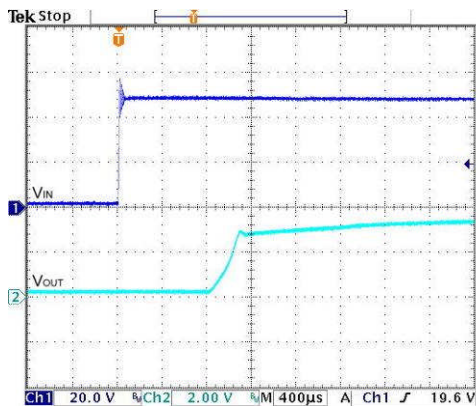

Typical Input Start-Up and Output Rise Characteristic
Vin=Vin(nom), Full Load

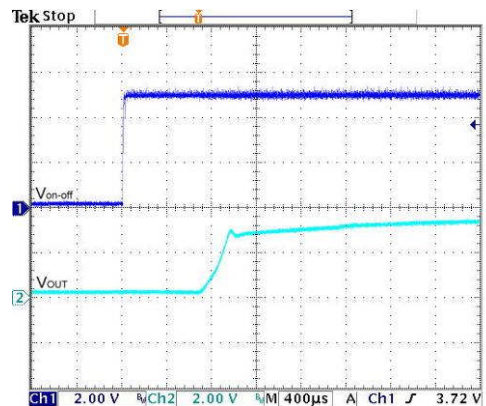

Using ON/OFF Voltage Start-Up and Vo Rise Characteristic
Vin=Vin(nom), Full Load

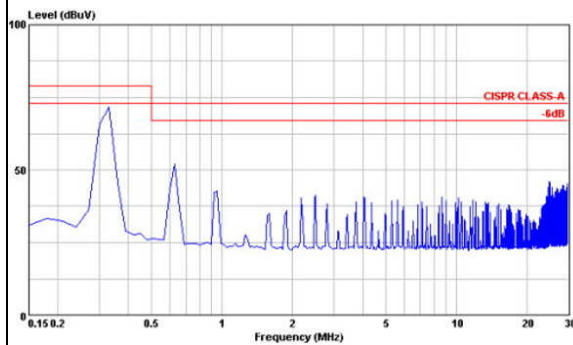

Conduction Emission of EN55022 Class A
Vin=Vin(nom), Full Load

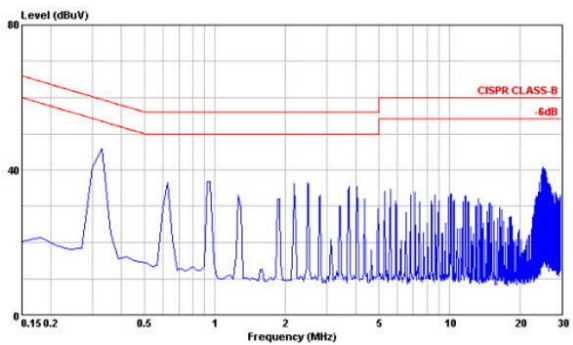

Conduction Emission of EN55022 Class B
Vin=Vin(nom), Full Load

Characteristic Curves (Continued)

All test conditions are at 25°C. The figures are for PXF40-48WS05.

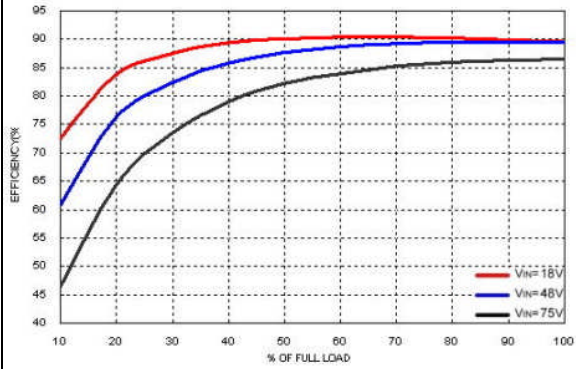

Efficiency Versus Output Current

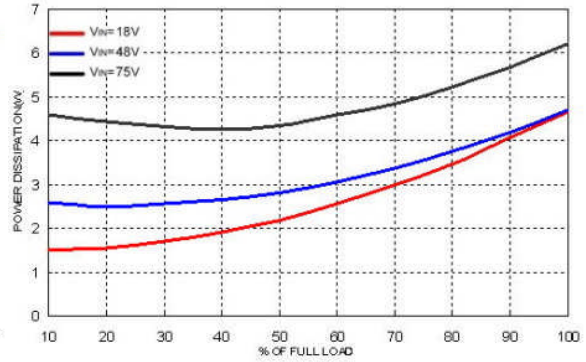

Power Dissipation Versus Output Current

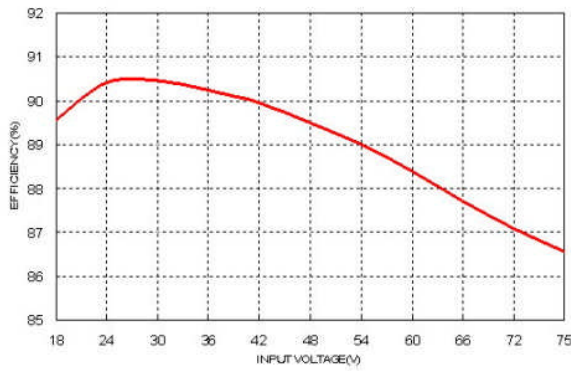

Efficiency Versus Input Voltage. Full Load

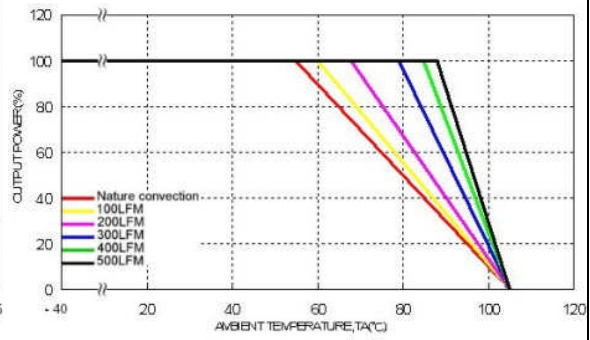

Derating Output Current Versus Ambient Temperature and Airflow
Vin=Vin(nom)

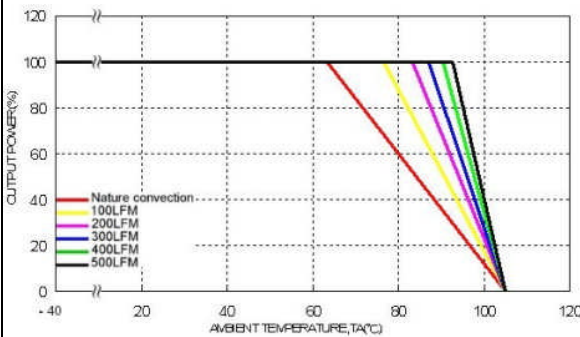

Derating Output Current Versus Ambient Temperature with Heat-Sink
and Airflow, Vin = Vin(nom)

Characteristic Curves (Continued)

All test conditions are at 25°C. The figures are for PXF40-48WS05.

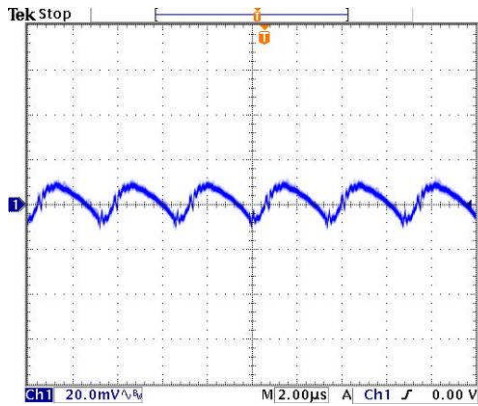

Typical Output Ripple and Noise.
Vin=Vin(nom), Full Load

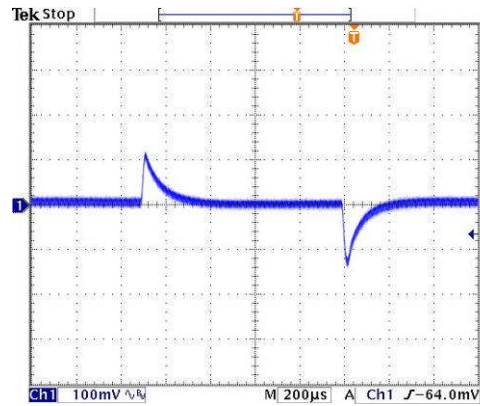

Transient Response to Dynamic Load Change from 100% to 75% to 100% of Full Load ; Vin=Vin(nom)

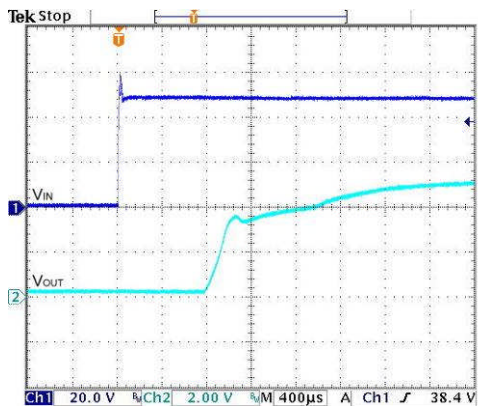

Typical Input Start-Up and Output Rise Characteristic
Vin=Vin(nom), Full Load

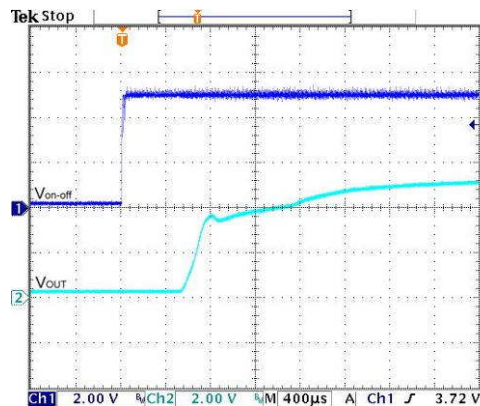

Using ON/OFF Voltage Start-Up and Vo Rise Characteristic
Vin=Vin(nom), Full Load

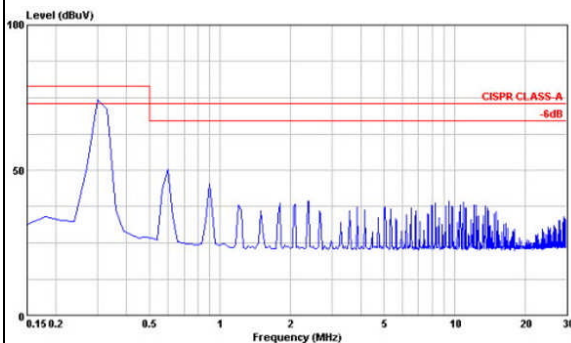

Conduction Emission of EN55022 Class A
Vin=Vin(nom), Full Load

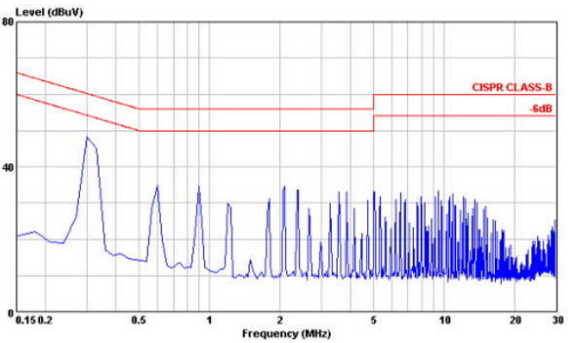

Conduction Emission of EN55022 Class B
Vin=Vin(nom), Full Load

Characteristic Curves (Continued)

All test conditions are at 25°C. The figures are for PXF40-48WS12.

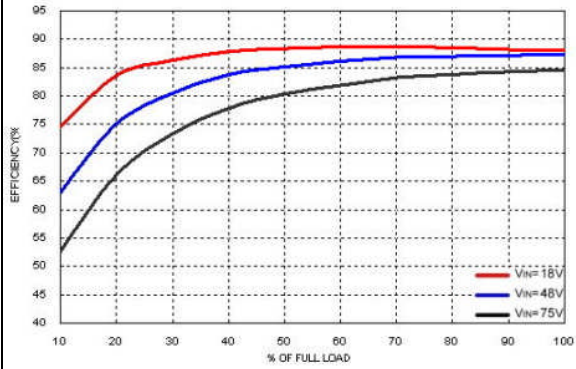

Efficiency Versus Output Current

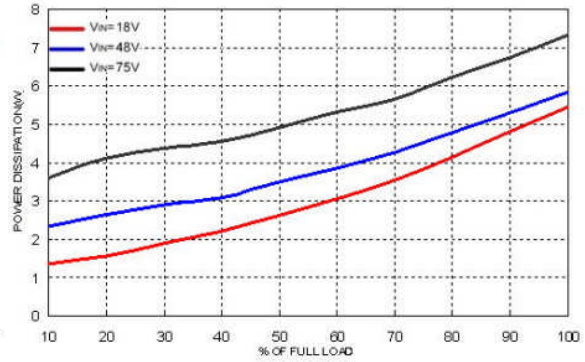

Power Dissipation Versus Output Current

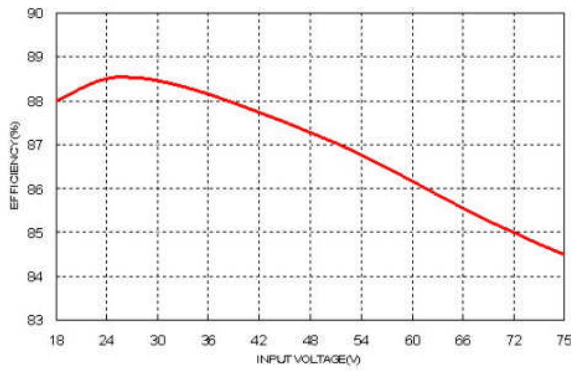

Efficiency Versus Input Voltage. Full Load

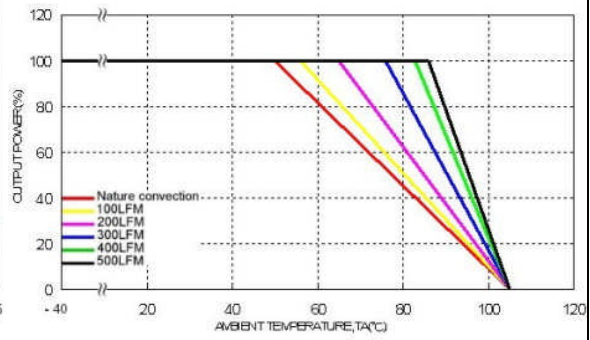

Derating Output Current Versus Ambient Temperature and Airflow
Vin=Vin(nom)

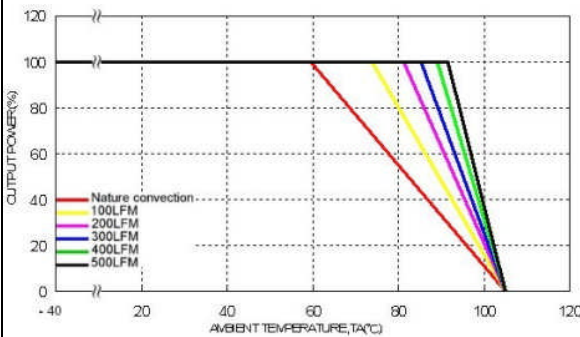

Derating Output Current Versus Ambient Temperature with Heat-Sink and Airflow, Vin = Vin(nom)

Characteristic Curves (Continued)

All test conditions are at 25°C. The figures are for PXF40-48WS12.

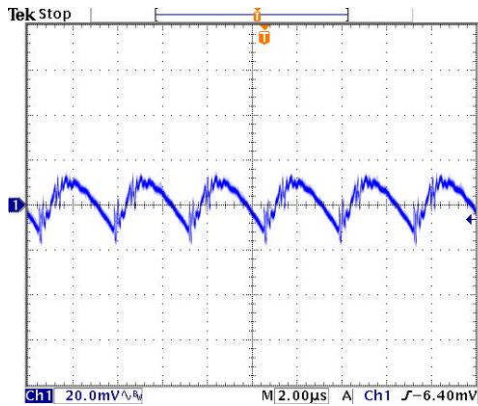

Typical Output Ripple and Noise.
Vin=Vin(nom), Full Load

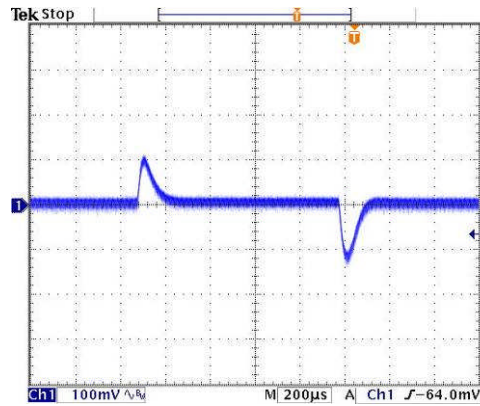

Transient Response to Dynamic Load Change from 100% to 75% to 100% of Full Load ; Vin=Vin(nom)

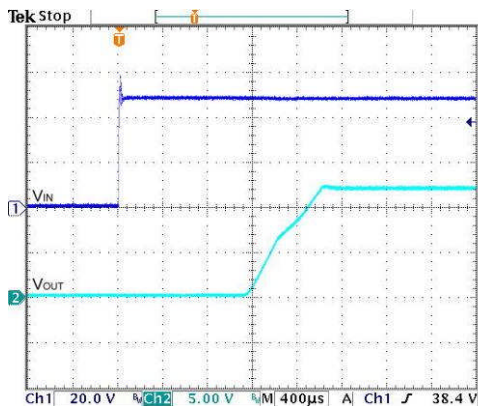

Typical Input Start-Up and Output Rise Characteristic
Vin=Vin(nom), Full Load

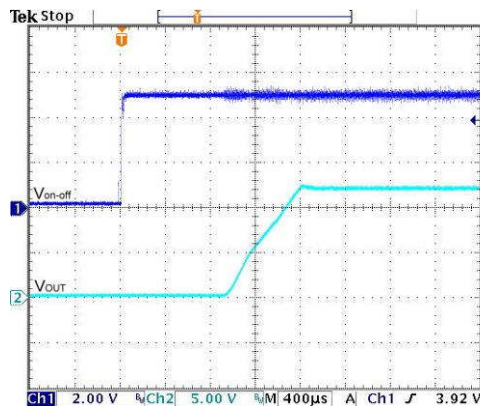

Using ON/OFF Voltage Start-Up and Vo Rise Characteristic
Vin=Vin(nom), Full Load

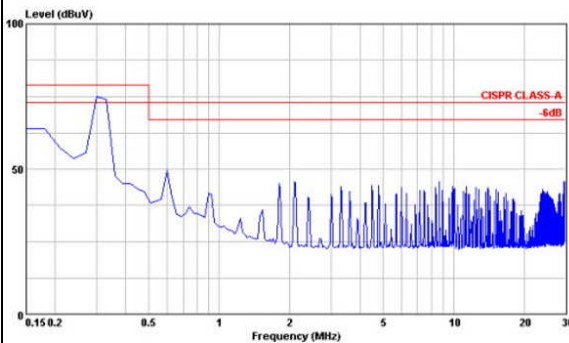

Conduction Emission of EN55022 Class A
Vin=Vin(nom), Full Load

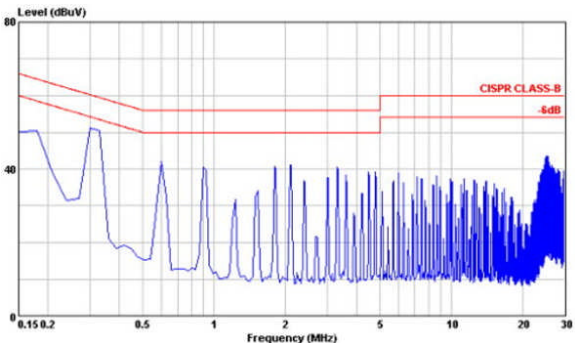

Conduction Emission of EN55022 Class B
Vin=Vin(nom), Full Load

Characteristic Curves (Continued)

All test conditions are at 25°C. The figures are identical for PXF40-48WS15.

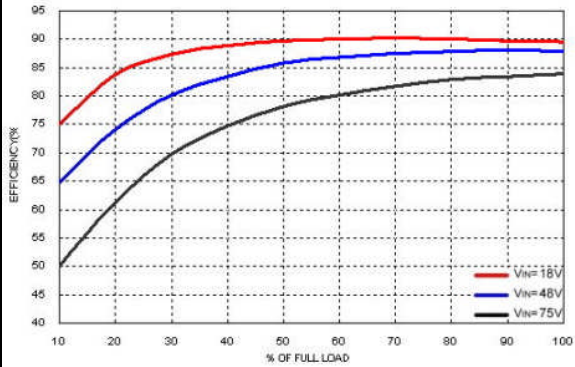

Efficiency Versus Output Current

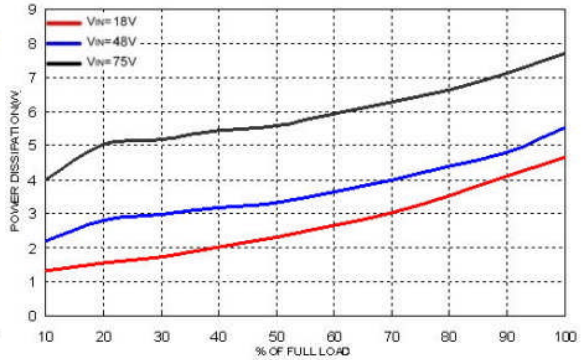

Power Dissipation Versus Output Current

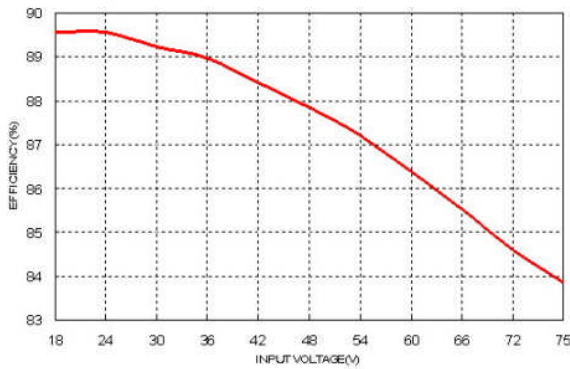

Efficiency Versus Input Voltage. Full Load

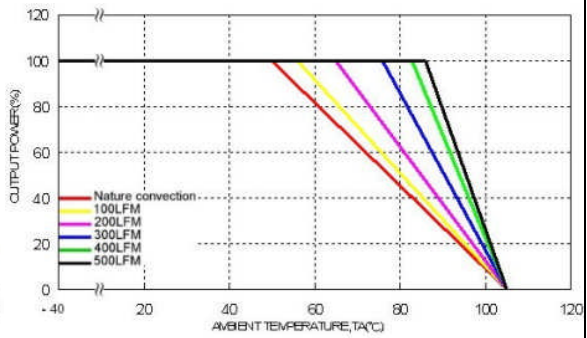

Derating Output Current Versus Ambient Temperature and Airflow
 $V_{in}=V_{in}(nom)$

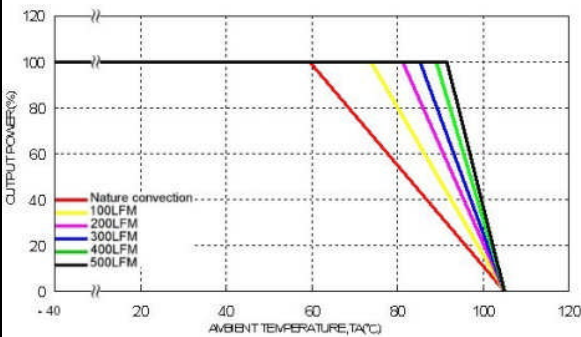

Derating Output Current Versus Ambient Temperature with Heat-Sink
and Airflow, $V_{in} = V_{in}(nom)$

Characteristic Curves (Continued)

All test conditions are at 25°C. The figures are for PXF40-48WS15.

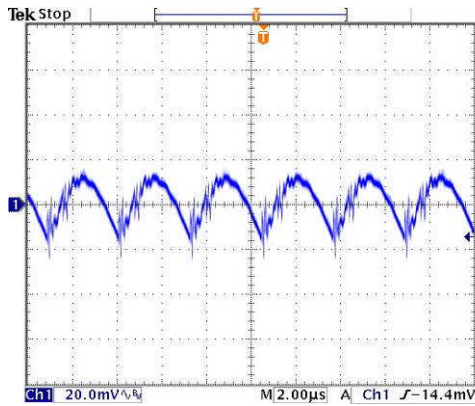

Typical Output Ripple and Noise.
Vin=Vin(nom), Full Load

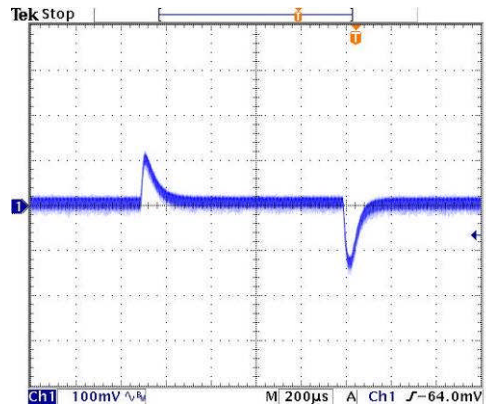

Transient Response to Dynamic Load Change from 100% to 75% to 100% of Full Load ; Vin=Vin(nom)

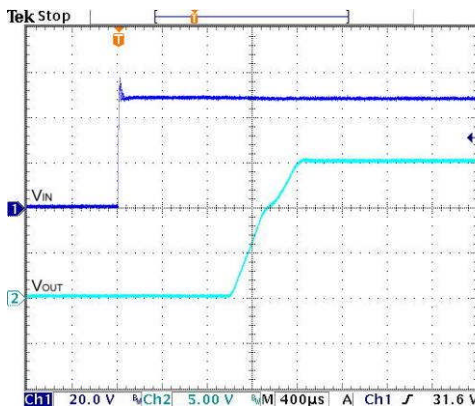

Typical Input Start-Up and Output Rise Characteristic
Vin=Vin(nom), Full Load

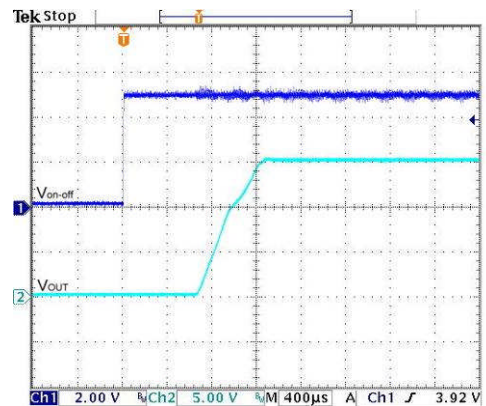

Using ON/OFF Voltage Start-Up and V_O Rise Characteristic
Vin=Vin(nom), Full Load

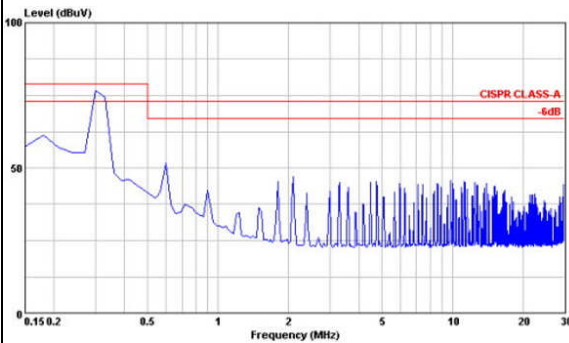

Conduction Emission of EN55022 Class A
Vin=Vin(nom), Full Load

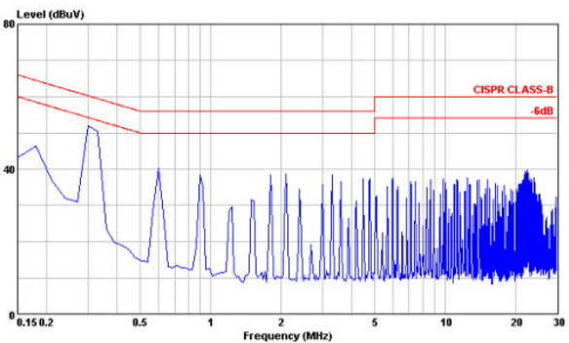

Conduction Emission of EN55022 Class B
Vin=Vin(nom), Full Load

Test Configurations

Input reflected-ripple current measurement test:

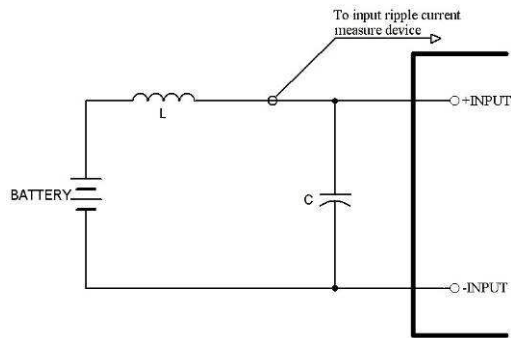

Component	Value	Voltage	Reference
L	12μH	---	---
C	47μF	100V	Aluminum Electrolytic Capacitor

Peak-to-peak output ripple & noise measurement test:

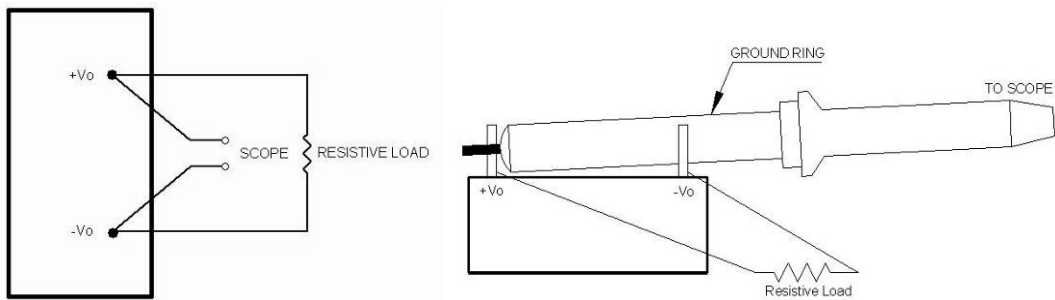

Output voltage and efficiency measurement test:

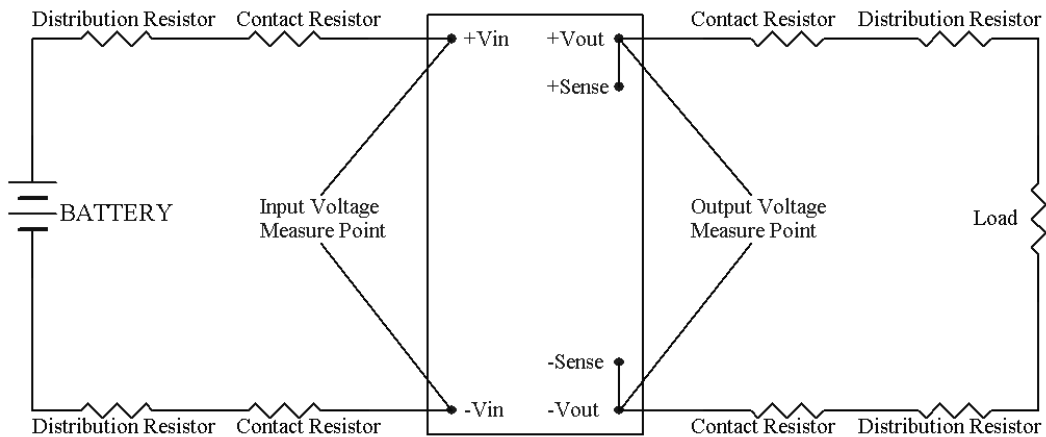

Note: All measurements are taken at the module terminals.

$$Efficiency = \left(\frac{V_o \times I_o}{V_{in} \times I_{in}} \right) \times 100\%$$

EMC Considerations

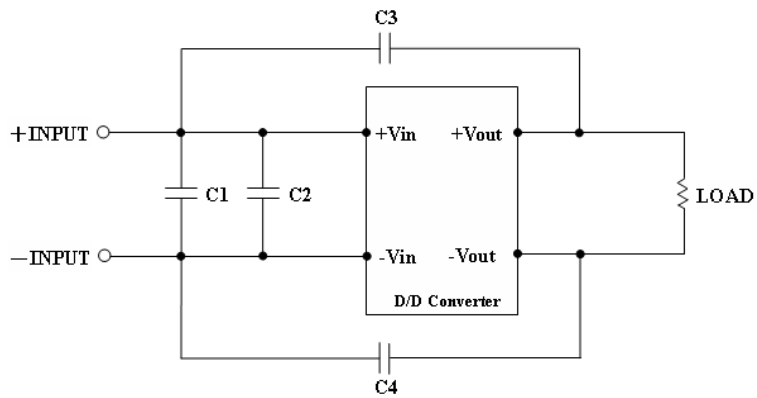

Suggested Schematic for EN55022 Conducted Emission Class A Limits

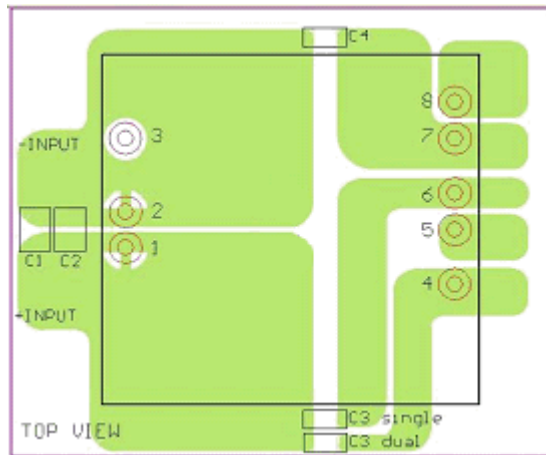

Recommended Layout with Input Filter

To meet conducted emissions EN55022 CLASS A the following components are needed:

PXF40-24WSxx

Component	Value	Voltage	Reference
C1,C2	---	---	---
C3,C4	1000pF	2KV	1206 MLCC

PXF40-48WSxx

Component	Value	Voltage	Reference
C1,C2	2.2uF	100V	1812 MLCC
C3,C4	1000pF	2KV	1206 MLCC

EMC Considerations (Continued)

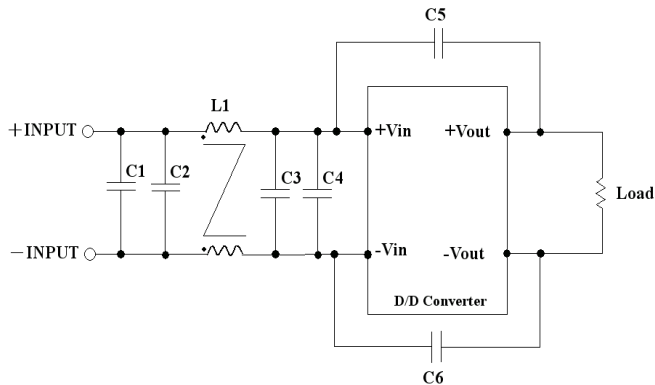

Suggested Schematic for EN55022 Conducted Emission Class B Limits

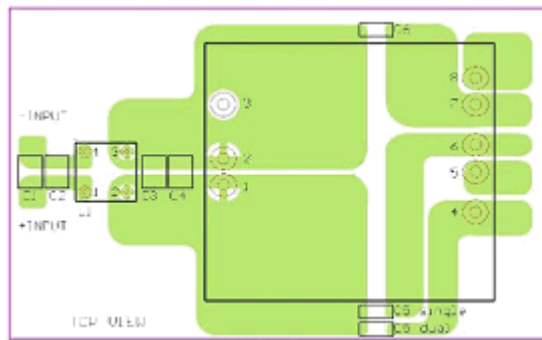

Recommended Layout with Input Filter

To meet conducted emissions EN55022 CLASS B the following components are needed:

PXF40-24WSxx

Component	Value	Voltage	Reference
C1,C3	4.7uF	50V	1812 MLCC
C5,C6	1000pF	2KV	1206 MLCC
L1	450uH	----	Common Choke

PXF40-48WSxx

Component	Value	Voltage	Reference
C1,C2	2.2uF	100V	1812 MLCC
C3,C4	2.2uF	100V	1812 MLCC
C5,C6	1000pF	2KV	1206 MLCC
L1	830uH	----	Common Choke

This Common Choke L1 is defined as follows:

- L: 450 μ H \pm 35% / DCR:25m Ω , max
A height:9.8 mm, Max
- L: 830 μ H \pm 35% / DCR:31m Ω , max
A height:8.8 mm, Max
- Test condition:100KHz / 100mV
- Recommended through hole: Φ 0.8mm
- All dimensions in millimeters

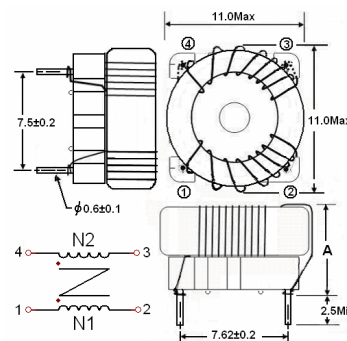

Input Source Impedance

The power module should be connected to a low impedance input source. Highly inductive source impedance can affect the stability of the DC-DC converter. Input external L-C filter is recommended to minimize input reflected ripple current. The inductor has a simulated source impedance of 12 μ H and the capacitor is Nippon chemi-con KZE series 47 μ F/100V. The capacitor must be located as close as possible to the input terminals of the converter for lower impedance.

Output Over Current Protection

When excessive output currents occur in the system, circuit protection is required on all converters. Normally, overload current is maintained at approximately 150 percent of rated current for PXF40-xxWsxx series.

Hiccup-mode is a method of operation in the converter whose purpose is to protect the converter from being damaged during an over-current fault condition. It also enables the converter to restart when the fault is removed.

One of the problems resulting from over current is that excessive heat may be generated in power devices; especially MOSFET and Schottky diodes and the temperature of those devices may exceed their specified limits. A protection mechanism has to be used to prevent those power devices from being damaged.

Output Over Voltage Protection

The output over-voltage protection consists of an output Zener diode that monitors the voltage on the output terminals. If the voltage on the output terminals exceeds the over-voltage protection threshold, then the Zener diode clamps the output voltage.

Thermal Consideration

The converter operates in a variety of thermal environments. Sufficient cooling should be provided to help ensure reliable operation of the unit. Heat is removed by conduction, convection, and radiation to the surrounding environment. Proper cooling can be verified by measuring the point as shown in the figure below. The temperature at this location should not exceed 105°C. When operating, adequate cooling must be provided to maintain the test point temperature at or below 105°C. Although the maximum point temperature of the converter is 105°C, limiting this temperature to a lower value will increase the reliability of the unit.

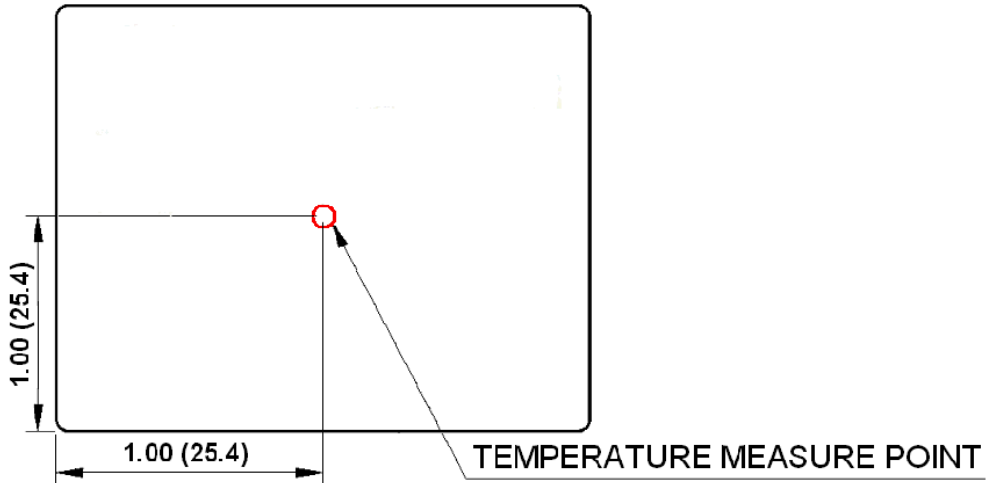

Heat Sink Consideration

Use heat-sink (7G-0026A) for lowering temperature; thus increasing the reliability of the converter.

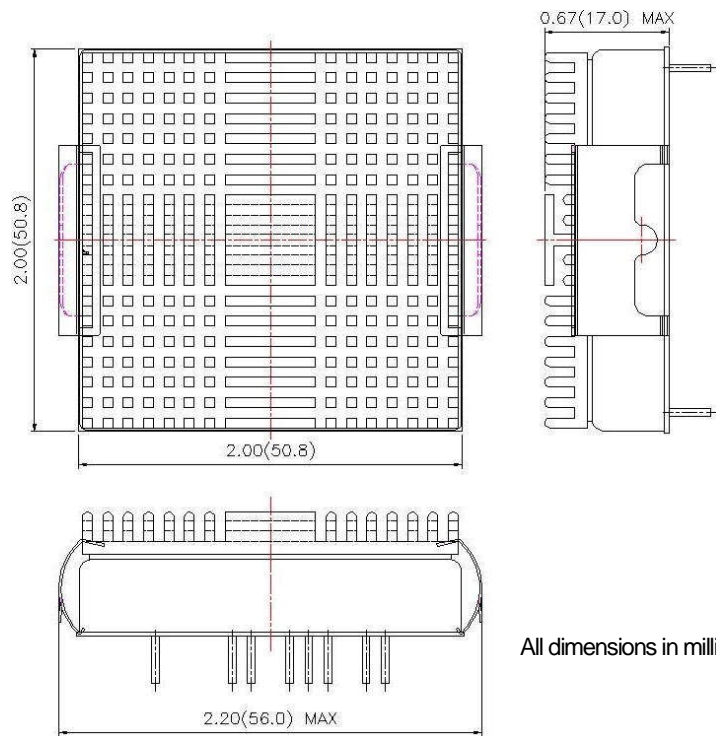

Remote ON/OFF Control

The Remote ON/OFF Pin is used to turn the converter on and off. The user must use a switch to control the logic voltage (high or low level) of the pin referenced to $V_i (-)$. The switch can be an open collector transistor, FET or Opto-Coupler. The switch must be capable of sinking up to 0.5 mA at low-level logic voltage. Using High-level logic, the maximum allowable leakage current of the switch at 12V is 0.5 mA.

Remote ON/OFF Implementation Circuits

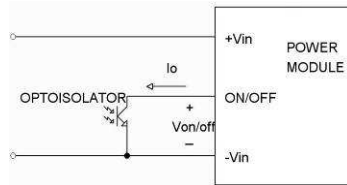

Isolated-Control Remote ON/OFF

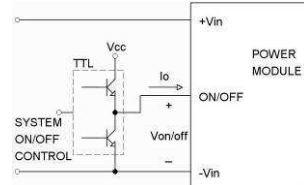

Level Control Using TTL Output

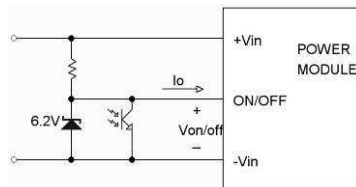

Level Control Using Line Voltage

There are two remote control options available, positive logic and negative logic.

a. Positive logic:

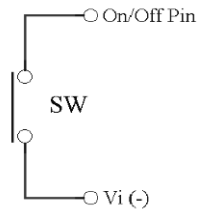

Turned off at Low-level logic

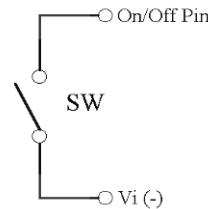

Turned on at High-level logic

b. Negative logic:

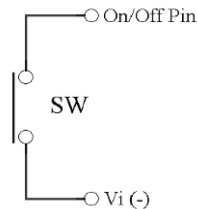

Turned on at Low-level logic

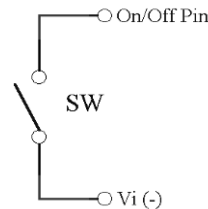

Turned off at High-level logic

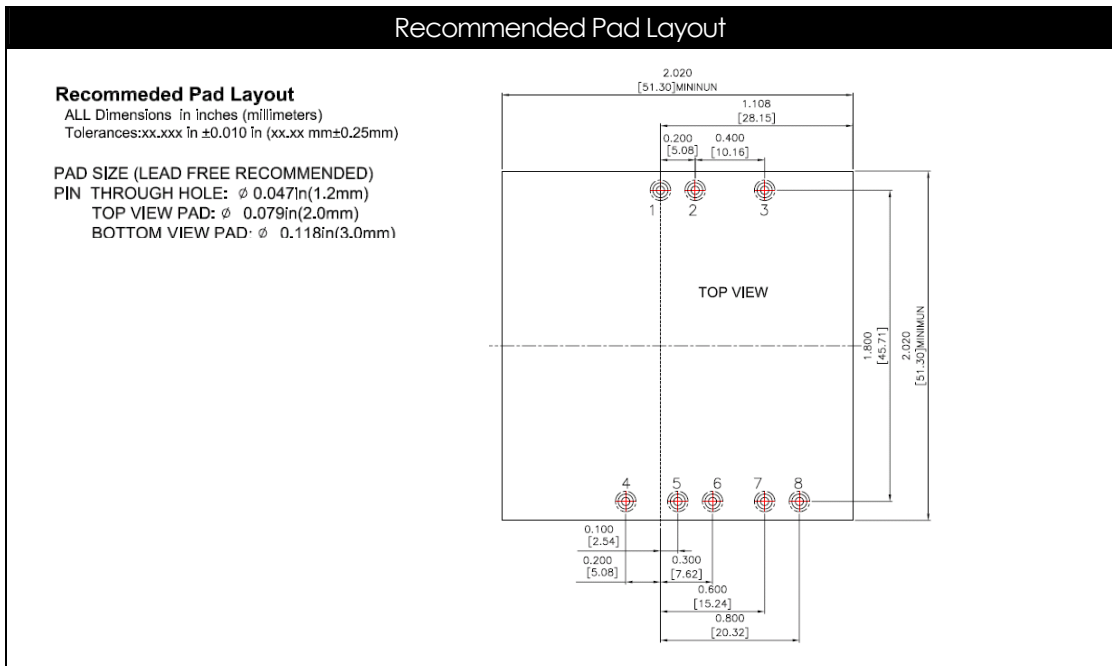
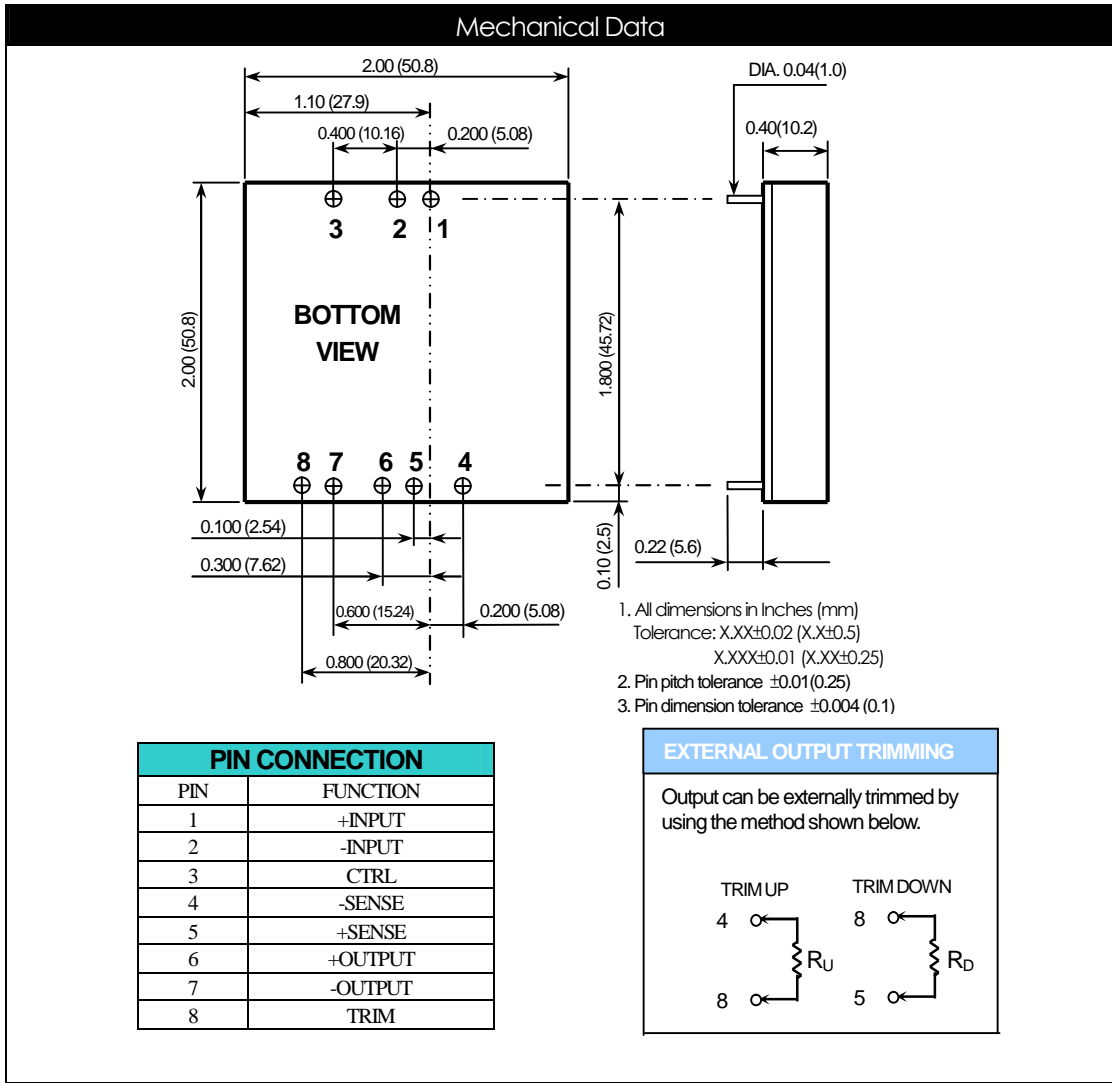

Output Voltage Adjustment

Output voltage set point adjustment allows the user to increase or decrease the output voltage set point of a module. This is accomplished by connecting an external resistor between the TRIM pin and either the SENSE(+) or SENSE(-) pins. With an external resistor between the TRIM and SENSE(-) pin, the output voltage set point increases. With an external resistor between the TRIM and SENSE(+) pin, the output voltage set point decreases.

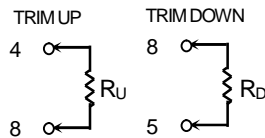

TRIM TABLE

PXF40-xxWS3P3

Trim up (%)	1	2	3	4	5	6	7	8	9	10
V _{OUT} (Volts)=	3.333	3.366	3.399	3.432	3.465	3.498	3.531	3.564	3.597	3.630
R _U (K Ohms)=	57.930	26.165	15.577	10.283	7.106	4.988	3.476	2.341	1.459	0.753
Trim down (%)	1	2	3	4	5	6	7	8	9	10
V _{OUT} (Volts)=	3.267	3.234	3.201	3.168	3.135	3.102	3.069	3.036	3.003	2.970
R _D (K Ohms)=	69.470	31.235	18.490	12.117	8.294	5.745	3.924	2.559	1.497	0.647

PXF40-xxWS05

Trim up (%)	1	2	3	4	5	6	7	8	9	10
V _{OUT} (Volts)=	5.050	5.100	5.150	5.200	5.250	5.300	5.350	5.400	5.450	5.500
R _U (K Ohms)=	36.570	16.580	9.917	6.585	4.586	3.253	2.302	1.588	1.032	0.588
Trim down (%)	1	2	3	4	5	6	7	8	9	10
V _{OUT} (Volts)=	4.950	4.900	4.850	4.800	4.750	4.700	4.650	4.600	4.550	4.500
R _D (K Ohms)=	45.533	20.612	12.306	8.152	5.660	3.999	2.812	1.922	1.230	0.676

PXF40-xxWS12

Trim up (%)	1	2	3	4	5	6	7	8	9	10
V _{OUT} (Volts)=	12.120	12.240	12.360	12.480	12.600	12.720	12.840	12.960	13.080	13.200
R _U (K Ohms)=	367.910	165.950	98.636	64.977	44.782	31.318	21.701	14.488	8.879	4.391
Trim down (%)	1	2	3	4	5	6	7	8	9	10
V _{OUT} (Volts)=	11.880	11.760	11.640	11.520	11.400	11.280	11.160	11.040	10.920	10.800
R _D (K Ohms)=	460.990	207.950	123.600	81.423	56.118	39.249	27.199	18.162	11.132	5.509

PXF40-xxWS15

Trim up (%)	1	2	3	4	5	6	7	8	9	10
V _{OUT} (Volts)=	15.150	15.300	15.450	15.600	15.750	15.900	16.050	16.200	16.350	16.500
R _U (K Ohms)=	404.180	180.590	106.060	68.796	46.437	31.531	20.883	12.898	6.687	1.718
Trim down (%)	1	2	3	4	5	6	7	8	9	10
V _{OUT} (Volts)=	14.850	14.700	14.550	14.400	14.250	14.100	13.950	13.800	13.650	13.500
R _D (K Ohms)=	499.820	223.410	131.270	85.204	57.563	39.136	25.974	16.102	8.424	2.282

Remote Sense Application Circuit

The Remote Sense function, when used, regulates the voltage at the load terminals; this compensates for any voltage drop that may exist between the output of the converter and the load. The voltage compensation is limited to less than 10 % of the nominal output voltage rating of the converter. i.e.:

$$[V_o (+) \text{ to } V_o (-)] - [\text{Sense } (+) \text{ to } \text{Sense } (-)] < 10\% V_o$$

If the Remote Sense function is not used the SENSE (+) should be connected to OUTPUT (+) and the SENSE (-) should be connected to OUTPUT(-) of the converter.

RL1 and RL2 are conduction losses

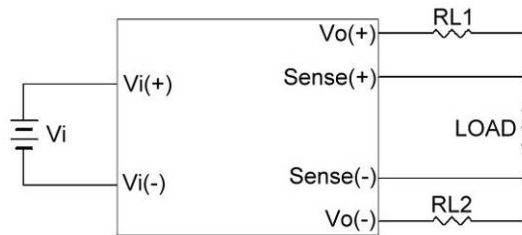

Remote Sense shown connected to the load.

Soldering Consideration

Lead free wave solder profile for PXF40WS-SERIES

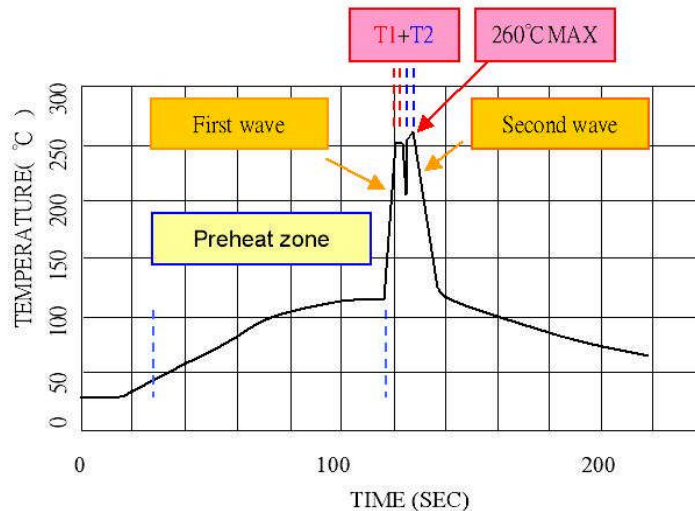

Zone	Reference Parameter
Preheat zone	Rise temp. speed : 3°C/ sec max. Preheat temp. : 100~130°C
Actual heating	Peak temp. : 250~260°C Peak time (T1+T2 time) : 4~6 sec

Reference Solder:Sn-Ag-Cu / Sn-Cu

Hand Welding:Soldering iron - Power 90W

Welding Time: 2-4 sec

Temp.:380-400 °C

Packaging Information

10 PCS per TUBE

Part Number Structure

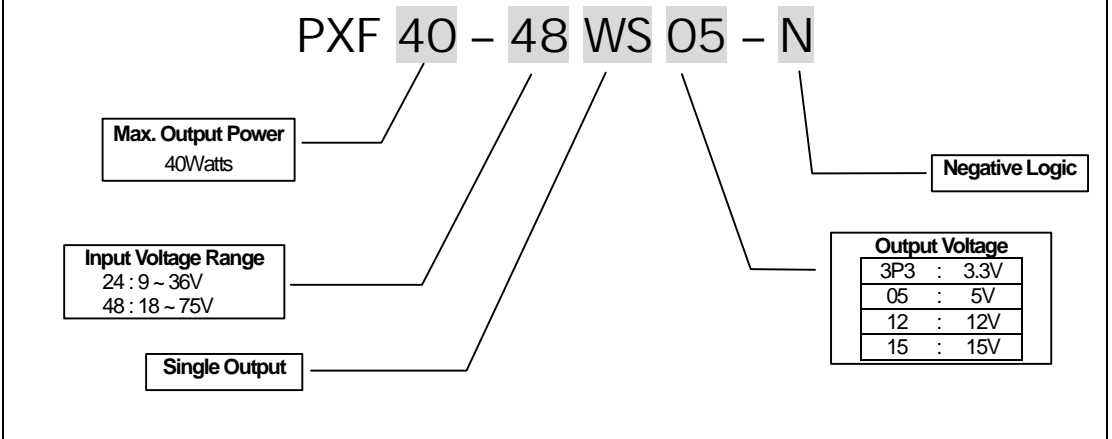

Model Number	Input Range	Output Voltage	Output Current	Input Current	Eff ⁽²⁾ (%)
			Full Load	Full Load ⁽¹⁾	
PXF40-24WS3P3	9 - 36 VDC	3.3 VDC	10000mA	1677mA	86
PXF40-24WS05	9 - 36 VDC	5 VDC	8000mA	2008mA	87
PXF40-24WS12	9 - 36 VDC	12 VDC	3333mA	2008mA	87
PXF40-24WS15	9 - 36 VDC	15 VDC	2666mA	2008mA	87
PXF40-48WS3P3	18 - 75 VDC	3.3 VDC	10000mA	838mA	86
PXF40-48WS05	18 - 75 VDC	5 VDC	8000mA	992mA	88
PXF40-48WS12	18 - 75 VDC	12 VDC	3333mA	1004mA	87
PXF40-48WS15	18 - 75 VDC	15 VDC	2666mA	1004mA	87

Note 1. Maximum value at nominal input voltage and full load.
 Note 2. Typical value at nominal input voltage and full load.

Safety and Installation Instruction**Fusing Consideration**

Caution: This converter is not internally fused. An input line fuse must always be used.

This encapsulated converter can be used in a wide variety of applications, ranging from simple stand-alone operation to an integrated part of a sophisticated power architecture. For maximum flexibility, internal fusing is not included; however, to achieve maximum safety and system protection, always use an input line fuse. The safety agencies require a slow-blow fuse with a maximum rating of 8A for PXF40-24WSxx converters and 5A for PXF40-48WSxx converters. Based on the information provided in this data sheet on Inrush energy and maximum DC input current; the same type of fuse with a lower rating can be used. Refer to the fuse manufacturer's data for further information.

MTBF and Reliability**The MTBF of PXF40-xxWSxx series of DC/DC converters has been calculated using:**

Bellcore TR-NWT-000332 Case I: 50% stress, Operating Temperature at 40°C (Ground fixed and controlled environment). The resulting figure for MTBF is 1.105×10^6 hours.

MIL-HDBK 217F NOTICE2 FULL LOAD, Operating Temperature at 25°C °C. The resulting figure for MTBF is 1.511×10^5 hours.