

Contactors

MC-Series

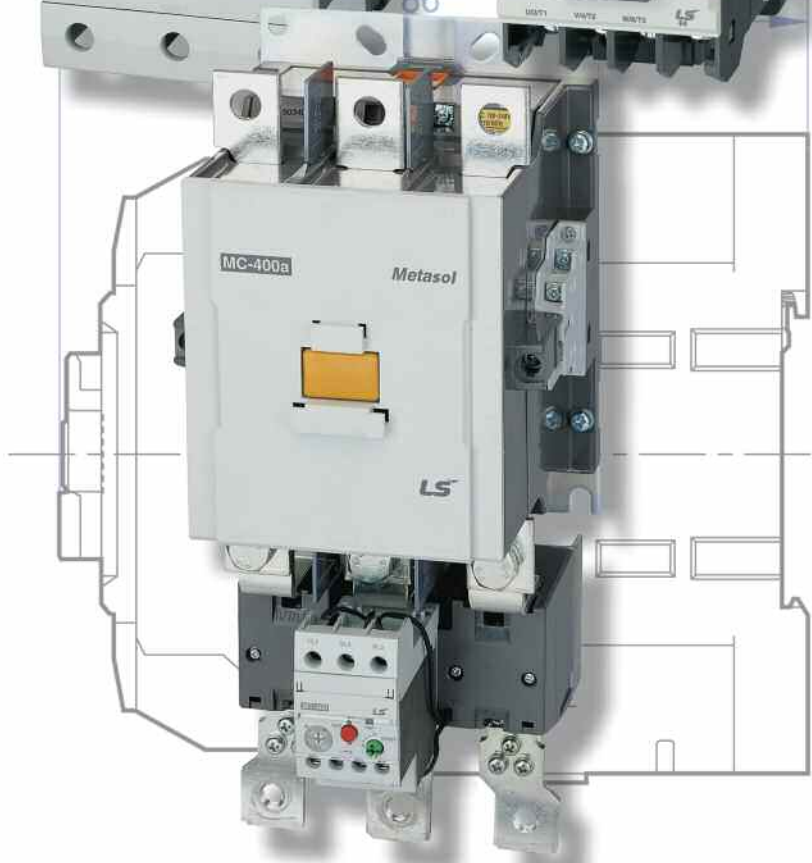

UL508
E108780



Standards and Certifications

- UL508
- IEC 60947-2 & IEC 60947-4-2
- CSA C22.2 No.14

Features

- 8 Frame Sizes
- 1/2HP up to 600HP @ 480V AC
- Screw Terminals (Lug Terminals Available)
- Direct Mounting Overload Relays
- Optional accessories
 - Additional Auxiliary contacts
 - Replacement Coils
 - Reversing Wiring Sets and Interlocks
 - Direct Wiring Adapters fro MMS
 - Coil surge Suppressors

General Specifications

Maximum Voltage	600V AC
Rated Frequency	50/60Hz
Operating Temperature	-5°C (23°F) to +40°C (104°F)
Degree of protection	IP20
Resistance to Vibration (5-300Hz)	> 15g
Flame Resistance	According to UL94

Terminal Size Acceptability and Torque

Wire Type	22AF	40AF	65-100AF	150AF	225AF	400AF	800AF
Solid	18-8 AWG	14-8AWG	12-4AWG	10AWG-1/0	8AWG - 300kcmil	8AWG - 400kcmil	2/0 - 700kcmil
Stranded	18-10AWG	14-8AWG	12-4AWG	10AWG-1/0	8AWG - 300kcmil	8AWG - 400kcmil	2/0 - 700kcmil
Ferrule	18-10AWG	18-10AWG	12-4AWG	10AWG-1/0	8AWG - 300kcmil	8AWG - 400kcmil	2/0 - 700kcmil
Torque	20 lb-in.	35 lb-in.	35 lb-in.	87 lb-in.	130 lb-in.	200 lb-in.	235 lb-in.

Contactors

3 Pole / Frame Size 22AF

Altech Corp.[®]



includes UA-1-11
Auxiliary switch,
(1NO/1NC)

Additional Auxiliaries
and other accessories
see page 11-13



Type	MC-9B	MC-12B	MC-18B	MC-22B
Number of Poles	3	3	3	3
NEMA Size	00	00	0	1
Standard Auxiliaries	1NO/1NC	1NO/1NC	1NO/1NC	1NO/1NC

	Coil Voltage	Frequency	Part. No.	Part. No.	Part. No.	Part. No.
AC Coil	24V	50/60 Hz	MC-9B-AC24V	MC-12B-AC24V	MC-18B-AC24V	MC-22B-AC24V
	120V	50/60 Hz	MC-9B-AC120V	MC-12B-AC120V	MC-18B-AC120V	MC-22B-AC120V
	208V	60 Hz	MC-9B-AC208V	MC-12B-AC208V	MC-18B-AC208V	MC-22B-AC208V
	230V	50/60 Hz	MC-9B-AC230V	MC-12B-AC230V	MC-18B-AC230V	MC-22B-AC230V
	480V	60 Hz	MC-9B-AC480V	MC-12B-AC480V	MC-18B-AC480V	MC-22B-AC480V

Other AC Coil Voltages Available:

60 Hz: 277V, 600V

50/ 60Hz: 48V, 100V, 110V, 200V, 220V, 240V, 380V, 415V, 440V, 500V, 550V

DC Coil	12V	—	MC-9B-DC12V	MC-12B-DC12V	MC-18B-DC12V	MC-22B-DC12V
	24V	—	MC-9B-DC24V	MC-12B-DC24V	MC-18B-DC24V	MC-22B-DC24V

Other DC Coil Voltages Available:

20V, 48V, 60V, 80V, 100V, 110V, 125V, 200V, 220V, 250V

HP Rating / UL508

		HP	HP	HP	HP
	Continuous current	25A	25A	40A	40A
Single phase	110~120V	0.5	0.75	1	2
	220~240V	1.5	2	3	3
Three phase	200~208V	2	3	5	7.5
	220~240V	3	5	7.5	10
	440~480V	5	7.5	10	15
	550~600V	7.5	10	15	20

Overload Relays
(Class 10A,
Differential Typical)



MT-32

Setting Ranges (A)

Frame Size 22AF

0.1-0.16A	MT-32/3K-0.16
0.16-0.25A	MT-32/3K-0.25
0.25-0.4A	MT-32/3K-0.4
0.4-0.63A	MT-32/3K-0.63
0.63-1A	MT-32/3K-1
1-1.6A	MT-32/3K-1.6
1.6-2.5A	MT-32/3K-2.5
2.4-4A	MT-32/3K-4
4-6A	MT-32/3K-6
5-8A	MT-32/3K-8
6-9A	MT-32/3K-9
7-10A	MT-32/3K-10
9-13A	MT-32/3K-13
12-18A	MT-32/3K-18
16-22A	MT-32/3K-22
18-25A	MT-32/3K-25
22-32A	MT-32/3K-32
28-40A	MT-32/3K-40

Drawings and other technical information can be found on page 14-20.

Contactors

3 Pole / Frame Size 40AF / 65F



includes 2 x UA-1-11
Auxiliary switch,
(2NO/2NC)

Additional Auxiliaries
and other accessories
see page 11-13



includes 2 x UA-1-11
Auxiliary switch,
(2NO/2NC)

Additional Auxiliaries
and other accessories
see page 11-13

Type	40AF		65AF	
	MC-32A	MC-40A	MC-50A*	MC-65A*
Number of Poles	3	3	3	3
NEMA Size	1	1	2	2
Standard Auxiliaries	2NO/2NC	2NO/2NC	2NO/2NC	2NO/2NC

	Coil Voltage	Frequency	Part. No.	Part. No.	Part. No.	Part. No.
AC Coil	24V	50/60 Hz	MC-32A-AC24V	MC-40A-AC24V	MC-50A-AC24V	MC-65A-AC24V
	120V	50/60 Hz	MC-32A-AC120V	MC-40A-AC120V	MC-50A-AC120V	MC-65A-AC120V
	208V	60 Hz	MC-32A-AC208V	MC-40A-AC208V	MC-50A-AC208V	MC-65A-AC208V
	230V	50/60 Hz	MC-32A-AC230V	MC-40A-AC2300V	MC-50A-AC230V	MC-65A-AC230V
	480V	60 Hz	MC-32A-AC480V	MC-40A-AC480V	MC-50A-AC480V	MC-65A-AC480V

Other AC Coil Voltages Available:

60 Hz: 277V, 600V
50/ 60Hz: 48V, 100V, 110V, 200V, 220V, 240V, 380V, 415V, 440V, 500V, 550V

	Coil Voltage	Frequency	Part. No.	Part. No.	Part. No.	Part. No.
DC Coil	12V	—	MC-32A-DC12V	MC-40A-DC12V	MC-50A-DC12V	MC-65A-DC12V
	24V	—	MC-32A-DC24V	MC-40A-DC24V	MC-50A-DC24V	MC-65A-DC24V

Other DC Coil Voltages Available:

20V, 48V, 60V, 80V, 100V, 110V, 125V, 200V, 220V, 250V

HP Rating / UL508	HP	HP	HP	HP
Continuous current	50A	60A	70A	100A
Single phase	110~120V	2	3	5
	220~240V	5	7.5	15
Three phase	200~208V	7.5	15	25
	220~240V	10	15	30
	440~480V	20	30	50
	550~600V	25	30	60

Overload Relays (Class 10A, Differential Typical)	Setting Ranges (A)	Frame Size 40AF	Frame Size 65AF
		0.1-0.16A	MT-32/3K-0.16
	0.16-0.25A	MT-32/3K-0.25	-
	0.25-0.4A	MT-32/3K-0.4	-
	0.4-0.63A	MT-32/3K-0.63	-
	0.63-1A	MT-32/3K-1	-
	1-1.6A	MT-32/3K-1.6	-
	1.6-2.5A	MT-32/3K-2.5	-
	2.4-4A	MT-32/3K-4	-
	4-6A	MT-32/3K-6	MT-63/3K-6
	5-8A	MT-32/3K-8	MT-63/3K-8
	6-9A	MT-32/3K-9	MT-63/3K-9
	7-10A	MT-32/3K-10	MT-63/3K-10
	9-13A	MT-32/3K-13	MT-63/3K-13
	12-18A	MT-32/3K-18	MT-63/3K-18
	16-22A	MT-32/3K-22	MT-63/3K-22
	18-25A	MT-32/3K-25	MT-63/3K-25
	22-32A	MT-32/3K-32	-
	28-40A	MT-32/3K-40	MT-63/3K-40
	34-50A	-	MT-63/3K-50
	45-65A	-	MT-63/3K-65



MT-63

* Lug terminals available; please add "L" to part number, e.g. MC-75A-AC24V-L.
Drawings and other technical information can be found on page 14-20.

Contactors

3 Pole / Frame Size 100AF



Altech Corp.[®]

includes 2 x UA-1-11
Auxiliary switch,
(2NO/2NC)

Additional Auxiliaries
and other accessories
see page 11-13

100AF

Type	MC-75A*	MC-85A*	MC-100A*
Number of Poles	3	3	3
NEMA Size	2	3	3
Standard Auxiliaries	2NO/2NC	2NO/2NC	2NO/2NC

	Coil Voltage	Frequency	Part. No.	Part. No.	Part. No.
AC Coil	24V	50/60 Hz	MC-75A-AC24V	MC-85A-AC24V	MC-100A-AC24V
	120V	50/60 Hz	MC-75A-AC120V	MC-85A-AC120V	MC-100A-AC120V
	208V	60 Hz	MC-75A-AC208V	MC-85A-AC208V	MC-100A-AC208V
	230V	50/60 Hz	MC-75A-AC230V	MC-85A-AC230V	MC-100A-AC230V
	480V	60 Hz	MC-75A-AC480V	MC-85A-AC480V	MC-100A-AC480V

Other AC Coil Voltages Available:

60 Hz: 277V, 600V

50/ 60Hz: 48V, 100V, 110V, 200V, 220V, 240V, 380V, 415V, 440V, 500V, 550V

DC Coil	12V	—	MC-75A-DC12V	MC-85A-DC12V	MC-100A-DC12V
	24V	—	MC-75A-DC24V	MC-85A-DC24V	MC-100A-DC24V

Other DC Coil Voltages Available:

20V, 48V, 60V, 80V, 100V, 110V, 125V, 200V, 220V, 250V

HP Rating / UL508

	HP	HP	HP
Continuous current	110A	135A	160A
Single phase	110~120V	5	7.5
	220~240V	15	20
Three phase	200~208V	25	30
	220~240V	30	40
	440~480V	50	75
	550~600V	60	75

Overload Relays

(Class 10A,
Differential Typical)



MT-95

Setting Ranges (A)

Frame Size 100AF

7-10A	MT-95/3K-10
9-13A	MT-95/3K-13
12-18A	MT-95/3K-18
16-22A	MT-95/3K-22
18-25A	MT-95/3K-25
22-32A	MT-95/3K-32
24-36A	MT-95/3K-36
28-40A	MT-95/3K-40
34-50A	MT-95/3K-50
45-65A	MT-95/3K-65
54-75A	MT-95/3K-75
63-85A	MT-95/3K-85
70-95A	MT-95/3K-95
80-100A	MT-95/3K-100

* Lug terminals available; please add "L" to part number, e.g. MC-75A-AC24V-L.

Drawings and other technical information can be found on page 14-20.

Contactors

3 Pole /Frame Size 150AF/225AF



includes 2 x UA-1-11
Auxiliary switch,
(2NO/2NC)

Additional Auxiliaries
and other accessories
see page 11-13



includes 2 x AU-100-11
Auxiliary switch,
(2NO/2NC)

Additional Auxiliaries
and other accessories
see page 11-13

150AF with Lug Terminals

225AF

Type	MC-130A*	MC-150A*	MC-185A	MC-225A
Number of Poles	3	3	3	3
NEMA Size	3	4	4	4
Standard Auxiliaries	2NO/2NC	2NO/2NC	2NO/2NC	2NO/2NC

	Coil Voltage	Frequency	Part. No.	Part. No.	Part. No.	Part. No.
AC Coil	24V	50/60 Hz	MC-130A-AC24V-L	MC-150A-AC24V-L	-	-
	110V	50/60 Hz	MC-130A-AC110V-L	MC-150A-AC110V-L	-	-
	220V	50/60 Hz	MC-130A-AC220V-L	MC-150A-AC220V-L	-	-
	300V	50/60 Hz	MC-130A-AC300V-L	MC-150A-AC300V-L	-	-
	400V	50/60 Hz	MC-130A-AC400V-L	MC-150A-AC400V-L	-	-
	500V	50/60 Hz	MC-130A-AC500V-L	MC-150A-AC500V-L	-	-
DC Coil	12V	-	MC-130A-DC12V-L	MC-150A-DC12V-L	-	-
	24V	-	MC-130A-DC24V-L	MC-150A-DC24V-L	-	-
	110V	-	MC-130A-DC110V-L	MC-150A-DC110V-L	-	-
	220V	-	MC-130A-DC220V-L	MC-150A-DC220V-L	-	-

AC/DC

Common Coil	Coil Voltage					
	AC 50/60Hz	DC				
	24-25V	24V	-	-	MC-185A-24V	MC-225A-24V
	48-50V	48V	-	-	MC-185A-48V	MC-225A-48V
	100-240V	100-220V	-	-	MC-185A-100/200V	MC-225A-100/200V
	265-347V	-	-	-	MC-185A-300V	MC-225A-300V
	380-450V	-	-	-	MC-185A-400V	MC-225A-400V
	440-575V	-	-	-	MC-185A-500V	MC-225A-500V

HP Rating / UL508

		HP	HP	HP	HP
	Continuous current	160A	210A	230A	275A
Single phase	110~120V	10	15	15	15
	220~240V	20	25	30	40
Three phase	200~208V	40	40	60	60
	220~240V	40	50	60	75
	440~480V	75	100	125	150
	550~600V	75	75	125	150

Overload Relays

(Class 10A,
Differential Typical)



MT-150

Setting Ranges (A)	Frame Size 150AF	Frame Size 225AF
34-50A	MT-150/3K-50	-
45-65A	MT-150/3K-65	-
54-75A	MT-150/3K-75	-
63-85A	MT-150/3K-85	-
65-100A	-	MT-225/3K-100
80-105A	MT-150/3K-105	-
85-125A	-	MT-225/3K-125
95-130A	MT-150/3K-130	-
110-150A	MT-150/3K-150	-
100-160A	-	MT-225/3K-160
120-185A	-	MT-225/3K-185
160-240A	-	MT-225/3K-240

* Screw terminals available; please remove "-L" from part number, e.g. MC-75A-AC24V.
Drawings and other technical information can be found on page 14-20.

Contactors

3 Pole / Frame Size 400AF



Altech Corp.[®]

includes 2 x AU-100-11
Auxiliary switch,
(2NO/2NC)

Additional Auxiliaries
and other accessories
see page 11-13

Type	MC-265A	MC-330A	MC-400A
Number of Poles	3	3	3
NEMA Size	5	5	5
Standard Auxiliaries	2NO/2NC	2NO/2NC	2NO/2NC

	Coil Voltage		Part. No.	Part. No.	Part. No.
AC/DC	AC 50/60Hz	DC			
Common Coil	100-240V	100-220V	MC-265A-100/200V	MC-330A-100/200V	MC-400A-100/200V
	265-347V	-	MC-265A-300V	MC-330A-300V	MC-400A-300V
	380-450V	-	MC-265A-400V	MC-330A-400V	MC-400A-400V
	440-575V	-	MC-265A-500V	MC-330A-500V	MC-400A-500V

HP Rating / UL508		HP	HP	HP
	Continuous current	300A	350A	450A
Single phase	110~120V	-	-	-
	220~240V	-	-	-
Three phase	200~208V	75	100	125
	220~240V	100	125	150
	440~480V	200	250	300
	550~600V	200	250	300

Overload Relays

(Class 10A,
Differential Typical)



MT-400

Setting Ranges (A)	Frame Size 400AF
85-125A	MT-400/3K-125
100-160A	MT-400/3K-160
120-185A	MT-400/3K-185
160-240A	MT-400/3K-240
200-330A	MT-400/3K-330
260-400A	MT-400/3K-400

Lug Terminals



Part. No.	Frame Size
AJ-220	225AF
AJ-400	400AF
AJ-800	800AF

Drawings and other technical information can be found on page 14-20.

Contactors

3 Pole / Frame Size 800AF



includes 2 x AU-100-11
Auxiliary switch,
(2NO/2NC)

Additional Auxiliaries
and other accessories
see page 11-13

800AF

Type	MC-500A	MC-630A	MC-800A
Number of Poles	3	3	3
NEMA Size	6	6	7
Standard Auxiliaries	2NO/2NC	2NO/2NC	2NO/2NC

AC/DC Common Coil	Coil Voltage		Part. No.	Part. No.	Part. No.
	AC 50/60Hz	DC			
	100-127V	100-110V	MC-500A-100V	MC-630A-100V	MC-800A-100V
	200-240V	200-220V	MC-500A-200V	MC-630A-200V	MC-800A-200V
	265-347V	-	MC-500A-300V	MC-630A-300V	MC-800A-300V
	380-450V	-	MC-500A-400V	MC-630A-400V	MC-800A-400V
	440-575V	-	MC-500A-500V	MC-630A-500V	MC-800A-500V

Rating / UL508		HP	HP	HP
	Continuous current	580A	660A	900A
Single phase	110~120V	-	-	-
	220~240V	-	-	-
Three phase	200~208V	150	200	200
	220~240V	200	250	300
	440~480V	400	500	600
	550~600V	400	500	600

Overload Relays (Class 10A, Differential Typical)



MT-800

Setting Ranges (A)	Frame Size 800AF
200-330A	MT-800/3K-330
260-400A	MT-800/3K-400
400-630	MT-800/3K-630
520-800A	MT-800/3K-800

Lug Terminals



Part. No.	Frame Size
AJ-220	225AF
AJ-400	400AF
AJ-800	800AF

Drawings and other technical information can be found on page 14-20.

Reversing Contactors

Reversing contactor consists of:

- Two AC or DC contactors
- Mechanical Interlock
- Wire Set (up to frame size 100A)

Assembled Reversing Contactors

Type	Type
MC-9B/R	MC-130A/R
MC-12B/R	MC-150A/R
MC-18B/R	MC-185A/R
MC-22B/R	MC-225A/R
MC-32A/R	MC-265A/R
MC-40A/R	MC-330A/R
MC-50A/R	MC-400A/R
MC-65A/R	MC-500A/R
MC-75A/R	MC-630A/R
MC-85A/R	MC-800A/R
MC-100A/R	

To create Part No. add "R" after frame size, eg. MC-32A/R-AC120V, MC-32A/R-DC24V, etc.
For available coil voltages see contactor pages 5-10.



MC-40A/R



MC-65A/R



MC-100A/R

Individual Components

Mechanical Interlocks

Interlock Part#	Contactor Type	Auxiliary Contacts
UR-02	MC-9B to MC-100A	2 x NC
AR-180	MC-180A to MC-400A	-
AR-600	MC-500A to MC-800A	-



Interlock unit

UR-02



AR-180

Wire Kits

Interlock Part#	Contactor Frame Size
UW-22	MC-9B to MC-22B
UW-32	MC-32A to MC-40A
UW-63	MC-50A, MC-65A
UW-95	MC-75A, MC-100A



Wire kit

UW-XX

Installation of Interlock and Wire Kits

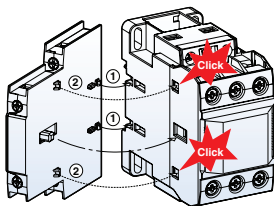

Install the interlock unit on the side of a contactor first. Fit each part as indicated in the figure above.

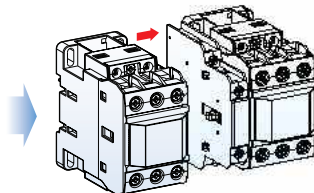

And then install the other contactor on the other side of the interlock unit as shown.

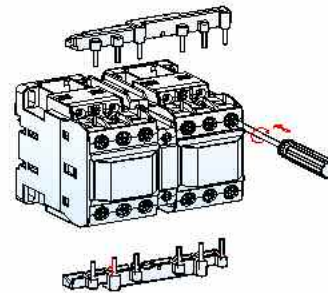

After installing interlock unit wiring kit can be assembled. Wiring kit contains two molded wires - one for line side and the other for load side.

Contactors Accessories

AUXILIARY CONTACTS

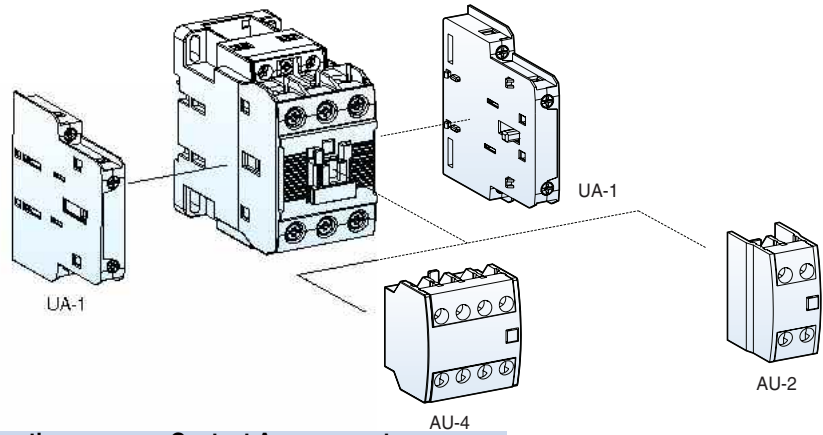

Frame Sizes 22AF - 150AF

Part No.	Poles	Configuration	Mounting	Contact Arrangement
UA-1-11	2	1NO/1NC	Side	
AU-2-20	2	2NO	Front	
AU-2-11	2	1NO/1NC	Front	
AU-2-02	2	2NC	Front	
AU-4-40	4	4NO	Front	
AU-4-31	4	3NO/1NC	Front	
AU-4-22	4	2NO/2NC	Front	
AU-4-13	4	1NO/3NC	Front	
AU-4-04	4	4NC	Front	

Frame Sizes 225AF - 800AF

Part No.	Poles	Configuration	Mounting	Contact Arrangement
AU-100-11	2	1NO/ 1NC	Side	



Installation Instructions

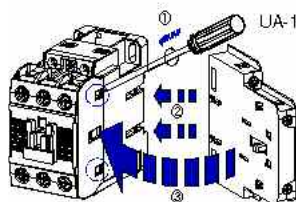

To install side mounting unit remove the indicated part in the circle in the fig. first. And then fit each part as shown. To separate push forward and pull.

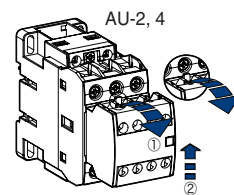

To install front mounting unit fit it on the upper part of the front of the contactor and push it down. To separate pull the lever of the unit and push the unit upward.



Surge Units (for use with frame sizes 22AF-100AF)

Part No.	Rated Voltage	Varistor	Internal Ratings Resistor	Capacitor
US-1	24-48VAC	120V	100 Ω	0.1 μF
US-2	100-125VAC	270V	100 Ω	0.1 μF
US-3	200-240VAC	470V	100 Ω	0.1 μF
US-4	24-48DC	120V	100 Ω	0.47 μF
US-5	100-125VDC	270V	100 Ω	0.47 μF
US-6	200-220VDC	470V	100 Ω	0.47 μF
US-11	24-48V AC/DC	120V	-	-
US-12	100-125V AC/DC	270V	-	-
US-13	200-240V AC/DC	470V	-	-
US-14	380-440V AC/DC	1000V	-	-
US-22	100-125VAC	-	56 Ω	0.1 μF

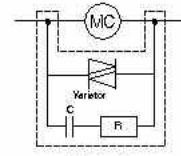

US-1~6

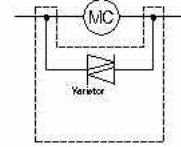

US-11~14

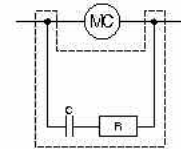

US-22

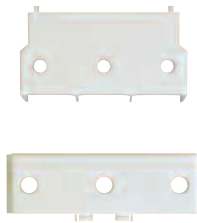

Terminal Covers

Part No.	Frame Size
AP-220	225AF
AP-400	400AF
AP-600	800AF



Insulation Barriers

Part No.	Frame Size
AI-180	225AF, 400AF
AI-600	800AF



Safety Cover*

Part No.	
AP-9	(Fits all sizes)

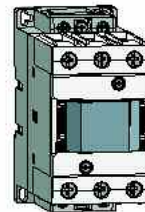

Bases for Separate Mounting Overload Relay

Part No.	Overload Relay
UZ-32	MT-32
UZ-63/S	MT-63
UZ-95/S	MT-95
UZ-150/S	MT-150A

Remote Reset Units for Overload Relay

Part No.	Cable Length (L)
UM-4R	400 mm
UM-5R	500 mm
UM-6R	600 mm



Dimensions Contactors

MC-9b~22b AC

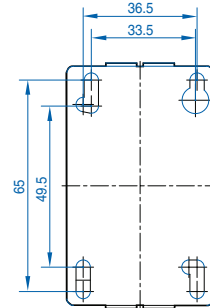
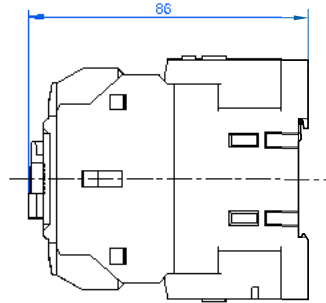
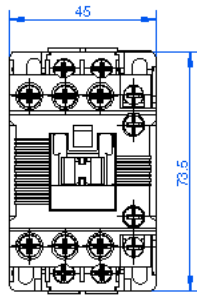

0.66 lb.

MC-9b~22b DC

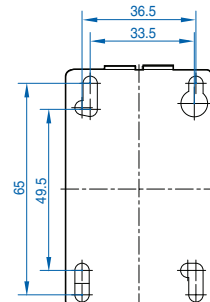
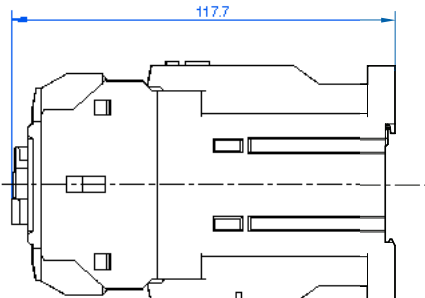
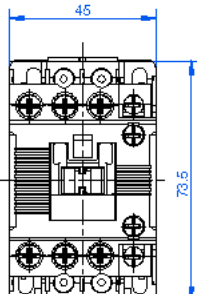

1.1 lb.

MC-32a~40a AC

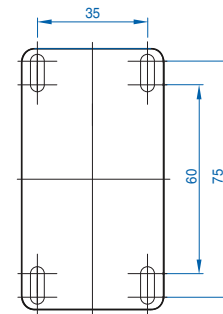
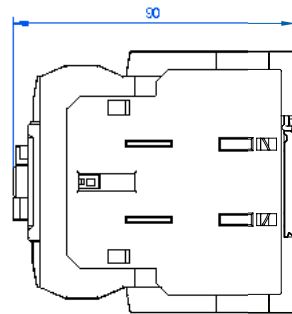
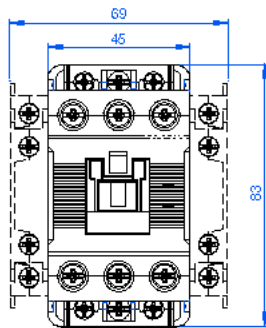

1.1 lb.

MC-32a~40a DC

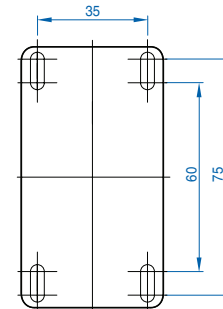
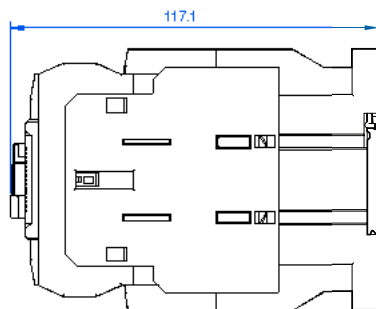
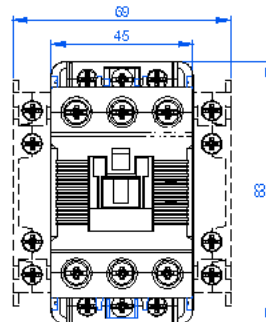

1.76 lb.

Dimensions in mm (to convert to inches multiply by 0.03937).

Dimensions Contactors

MC-50a-65a AC

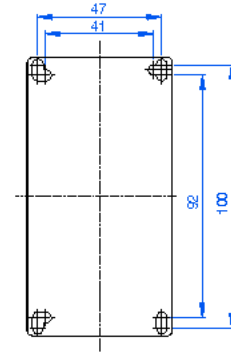
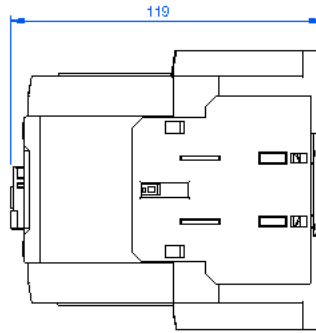
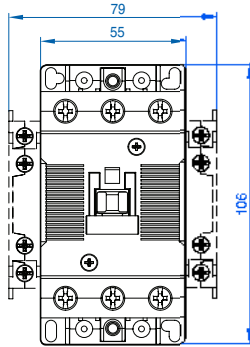

2.2 b.

MC-50a-65a DC

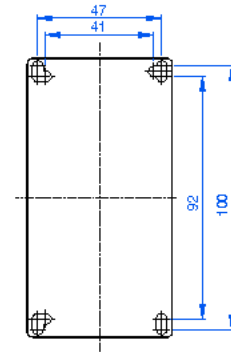
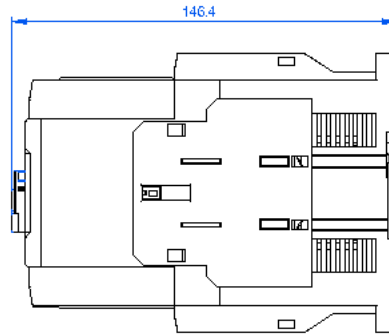
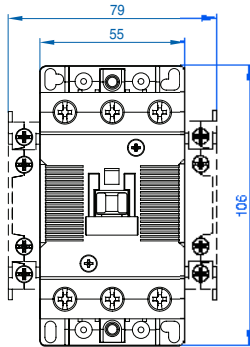

2.87 b.

MC-75a-100a AC

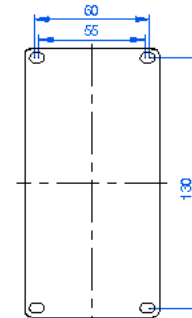
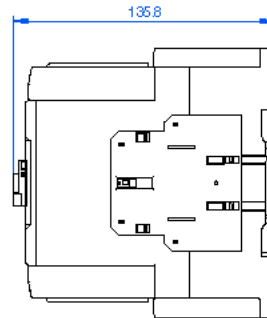
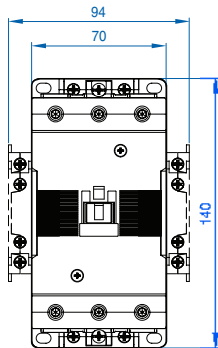

4.19 b.

MC-75a-100a DC

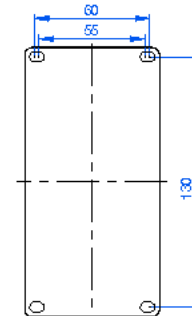
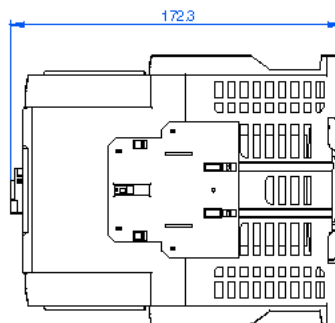
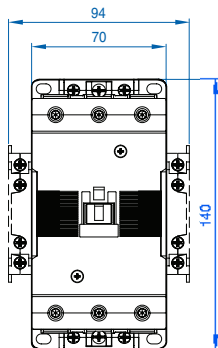

6.17 b.

Dimensions in mm (to convert to inches multiply by 0.03937).

Dimensions Contactors

MC-130a
MC-150a

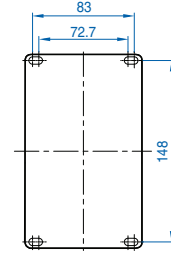
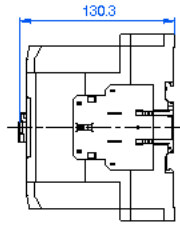
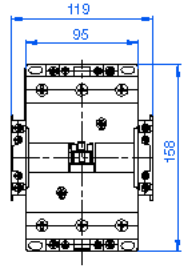

5.29 lb.

MC-185a
MC-225a

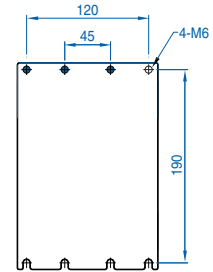
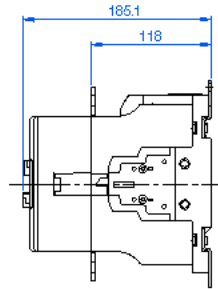
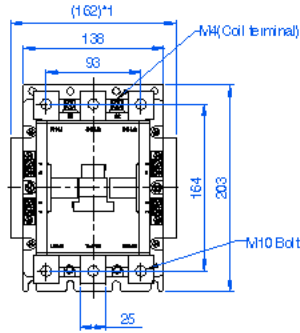

11.9 lb.

MC-265a
MC-330a
MC-400a

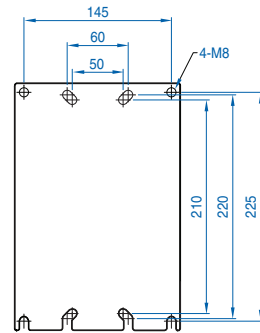
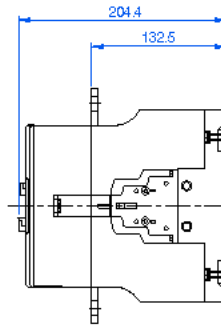
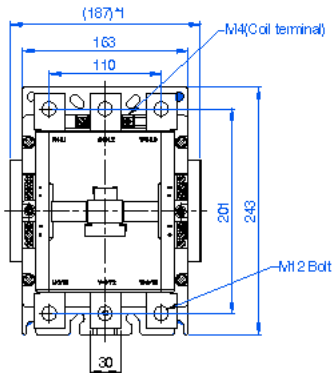

20.28 lb.

MC-500a
MC-630a
MC-800a

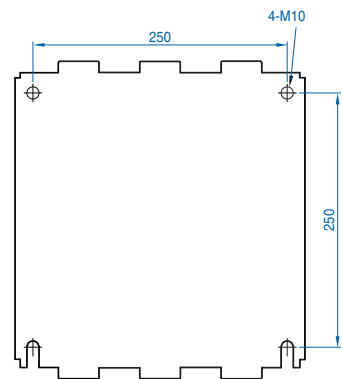
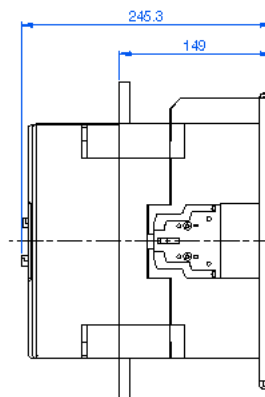
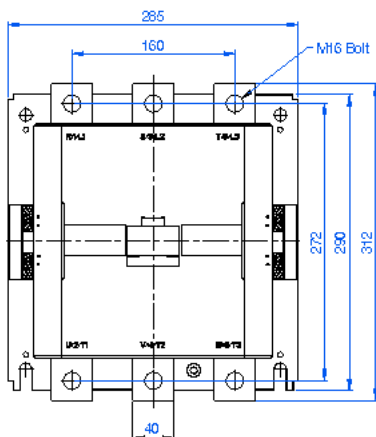

49.38 lb.

Dimensions in mm (to convert to inches multiply by 0.03937).

Dimensions Overload Relays

MT-12

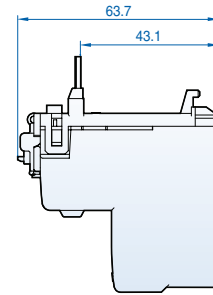
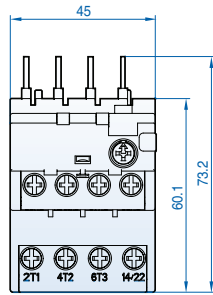

0.22 lb.

MT-32

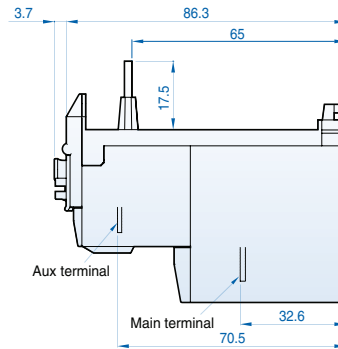
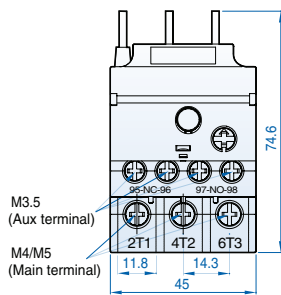

0.37 lb.

MT-63

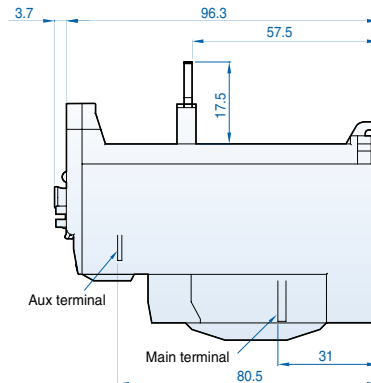
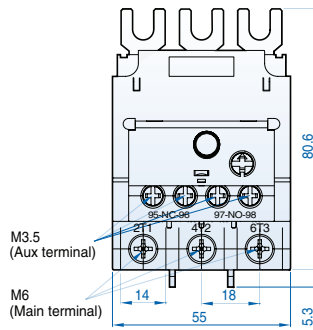

0.67 lb.

MT-95

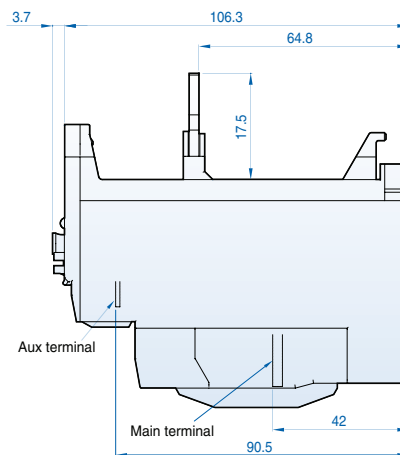
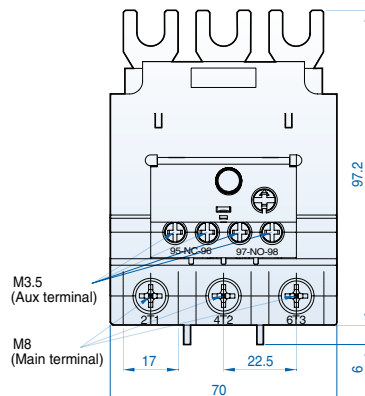

1.04 lb.

Dimensions in mm (to convert to inches multiply by 0.03937).

Dimensions Overload Relays

MT-150

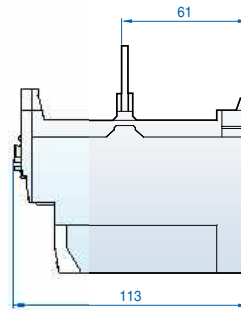
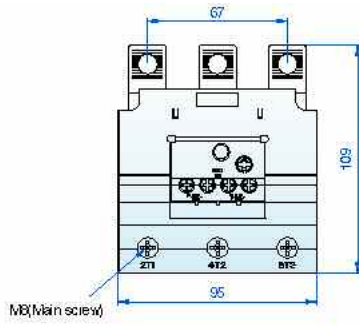

1.54 lb.

MT-225

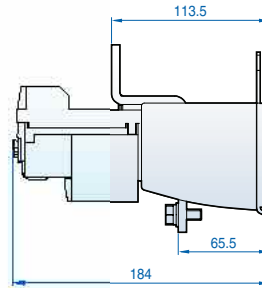
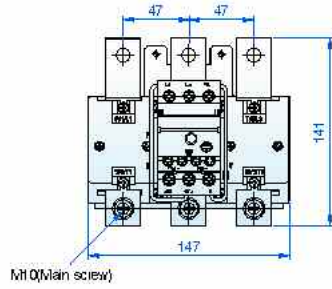

5.51 lb.

MT-400

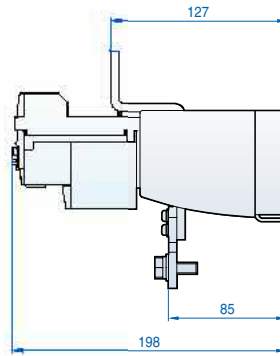
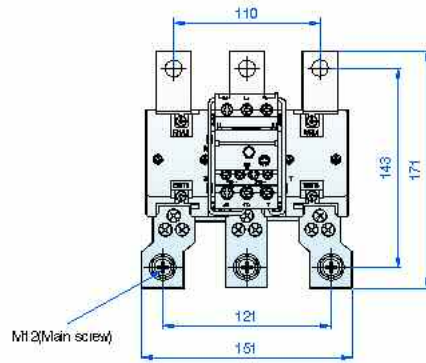

5.73 lb.

MT-800

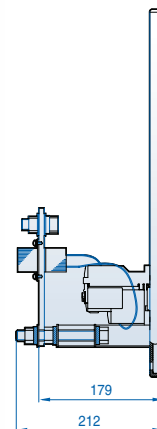
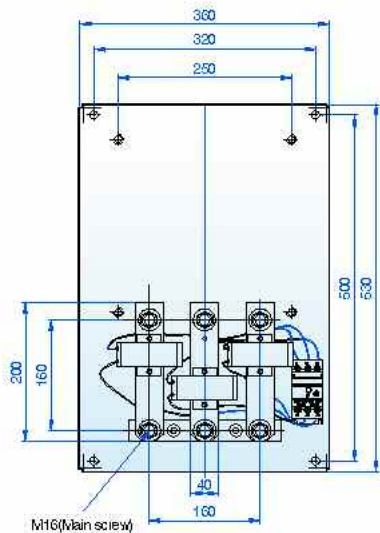

25.35 lb.

Dimensions in mm (to convert to inches multiply by 0.03937).

COIL CHARACTERISTIC AND DATA - MC SERIES

Type MC-9B~150A AC Coils

Frame Type	Rated Voltage	Inrush Current (A)		Holding Current (A)		Closing Time (ms)	Opening Time (ms)	Inrush (VA)	Holding (VA)	Consumption(W)		Pick-up Voltage		Drop-out Voltage	
		AC50HZ	AC60HZ	AC50HZ	AC60HZ					AC50HZ	AC60HZ	AC50HZ	AC60HZ	AC50HZ	AC60HZ
MC-9B~22B (50/60Hz)	24	2.975	2.915	0.430	0.330	12~22ms	4~19ms	90	11	2.1	1.5	16.0	18.5	11.00	11.0
	110	0.657	0.636	0.095	0.074	12~22ms	4~19ms	90	11	2.1	1.5	72.0	75.0	49.00	58.0
	220	0.340	0.320	0.040	0.028	12~22ms	4~19ms	90	11	2.1	1.5	140.0	142.0	100.00	105.0
	240	0.286	0.264	0.038	0.027	12~22ms	4~19ms	90	11	2.1	1.5	145.0	155.0	110.00	125.0
MC-9B~22B (60Hz)	208	-	0.340	-	0.042	12~22ms	4~19ms	90	11	-	1.5	-	133.0	-	100.0
	480	-	0.106	-	0.018	12~22ms	4~19ms	90	11	-	1.5	-	350.0	-	255.0
MC-32A, 40A (50/60Hz)	24	2.935	2.842	0.460	0.360	12~22ms	4~19ms	115	11	2.7	2.2	16.0	18.5	11.00	11.0
	110	0.652	0.631	0.100	0.077	12~22ms	4~19ms	115	11	2.7	2.2	75.0	75.0	48.00	57.0
	220	0.335	0.316	0.050	0.040	12~22ms	4~19ms	115	11	2.7	2.2	150.0	142.0	100.00	105.0
	240	0.289	0.264	0.046	0.035	12~22ms	4~19ms	115	11	2.7	2.2	145.0	155.0	110.00	125.0
MC-32A, 40A (60Hz)	208	-	0.340	-	0.044	12~22ms	4~19ms	115	11	-	2.2	-	133.0	-	100.0
	480	-	0.108	-	0.020	12~22ms	4~19ms	115	11	-	2.2	-	350.0	-	255.0
MC-50A, 60A (50/60Hz)	24	4.597	4.411	0.524	0.401	12~22ms	4~19ms	160	11	2.8	2.4	16.0	18.5	9.00	12.0
	110	1.025	0.994	0.114	0.085	12~22ms	4~19ms	160	11	2.8	2.4	69.0	77.0	53.00	59.0
	220	0.608	0.592	0.058	0.046	12~22ms	4~19ms	160	11	2.8	2.4	150.0	155.0	100.00	105.0
	240	0.474	0.425	0.053	0.039	12~22ms	4~19ms	160	11	2.8	2.4	145.0	165.0	115.00	125.0
MC-50A, 60A (60Hz)	208	-	0.600	-	0.048	12~22ms	4~19ms	160	11	-	2.4	-	85.0	-	100.0
	480	-	0.198	-	0.020	12~22ms	4~19ms	160	11	-	2.4	-	315.0	-	230.0
MC-75A~100A (50/60Hz)	24	7.956	7.765	0.768	0.645	15~30ms	10~30ms	190	16	5.4	4.7	16.0	17.5	11.50	14.0
	110	1.782	1.710	0.176	0.145	15~30ms	10~30ms	190	16	5.4	4.7	66.0	75.0	51.00	60.0
	220	1.018	0.980	0.078	0.062	15~30ms	10~30ms	190	16	5.4	4.7	150.0	160.0	100.00	105.0
	240	0.870	0.820	0.082	0.066	15~30ms	10~30ms	190	16	5.4	4.7	133.0	170.0	105.00	115.0
MC-75A~100A (60Hz)	208	-	1.013	-	0.065	15~30ms	10~30ms	190	16	-	4.7	-	135.0	-	100.0
	480	-	0.460	-	0.035	15~30ms	10~30ms	190	16	-	4.7	-	330.0	-	265.0
MC-130A, 150A (50/60Hz)	24	8.800	9.190	0.350	0.410	20~40ms	60~70ms	220	25	2.7	3.6	18.0	17.5	14.00	13.0
	48	3.950	4.240	0.168	0.198	20~40ms	60~70ms	220	25	2.7	3.6	34.0	37.1	25.00	23.0
	110	1.500	1.580	0.205	0.231	20~40ms	60~70ms	220	25	2.7	3.6	84.0	80.0	60.00	55.0
	220	0.720	0.760	0.085	0.099	20~40ms	60~70ms	220	25	2.7	3.6	165.0	160.0	105.00	100.0
	300	0.690	0.710	0.050	0.059	20~40ms	60~70ms	220	25	2.7	3.6	210.0	200.0	165.00	160.0
	400	0.490	0.500	0.040	0.046	20~40ms	60~70ms	220	25	2.7	3.6	280.0	270.0	240.00	200.0
	500	0.310	0.320	0.027	0.032	20~40ms	60~70ms	220	25	2.7	3.6	360.0	340.0	290.00	270.0

Type MC-9B~150A DC Coils

Frame Type	Rated Voltage	Inrush Current(A)	Holding Current (A)	Pick-up Voltage	Drop-out Voltage	Closing time (ms)	Opening time (ms)
MC-6A~22B	12	0.790	0.790	7.5	3.0	35~50ms	4~19ms
	24	0.380	0.380	16.0	5.5		
MC-32A, 40A	12	0.702	0.702	8.5	3.4	50~65ms	4~19ms
	24	0.350	0.350	16.3	6.3		
MC-50A, 65A	12	0.790	0.790	8.7	2.6	50~65ms	4~19ms
	24	0.380	0.380	17.5	5.0		
MC-75A~100A	12	0.790	1.450	8.1	2.5	100~120ms	10~25ms
	24	0.380	0.740	17.5	4.4		
MC-130A, 150A	24	6.700	0.240	17.5	4.5	70~80ms	60~70ms
	48	3.300	0.155	33.0	11.0		
	110	2.000	0.068	75.0	25.0		
	220	0.950	0.040	150.0	50.0		

Type MC-185A~800A AC/DC Common Coils

Frame Type	Rated Voltage	Voltage	Inrush Current (A)			Holding Current (mA)			Closing Time (ms)			Opening Time (ms)			Coli Consumption(W)		
			AC50HZ	AC60HZ	DC	AC50HZ	AC60HZ	DC	AC50HZ	AC60HZ	DC	AC50HZ	AC60HZ	DC	AC50HZ	AC60HZ	DC
MC-185A,225A	24V	24	9.53	9.6	7	307	319	143	41	40	38.1	65.3	35	39.9	3.6	3.6	3.5
	48V	48	3.836	3.774	2.71	70	72	39	51.7	45.7	43.8	38.6	40.7	46.8	2.2	2.3	1.9
	100~240V	110	2.108	2.092	1.532	57	57	36	53.38	52.2	53.3	66.1	64.4	67.8	4.1	4.1	4.3
MC-265A~400A	100~240V	220	1.256	1.22	1.34	42	43	22	43.5	41.7	41	67.2	67.6	68.8	6.3	6.2	5.8
	100~240V	110	4.3	4.33	4.2	443	434	439	47.8	50.3	48.7	57	56	55.8	5.8	5.7	6.3
MC-500A~800A	100V	110	11.2	10.7	18.2	91	91	46	55.2	56	50.5	41	40	41	5.3	5.3	6
	200V	220	5.2	4.9	6.1	68	67	34	56.3	55.7	55.3	38	35.5	37.2	8.3	8.5	8.6

IEC Ratings

MC Series

IEC Ratings (AC-1, AC-3) MC - Series

Type IEC60947-4 Ratings	MC-9B		MC-12B		MC-18B		MC-22B		MC-32A		MC-40A		MC-50A	
	kW	A	kW	A	kW	A	kW	A	kW	A	kW	A	kW	A
AC-1	-	25	-	25	-	32	-	40	-	50	-	60	-	70
AC-3 200/240V	2.5	11	3.5	13	4.5	18	5.5	22	7.5	32	11	40	15	55
380/440V	4	9	5.5	12	7.5	18	11	22	15	32	18.5	40	22	50
500/550V	4	7	7.5	12	7.5	13	15	20	18.5	28	22	32	30	43
690V	4	6	7.5	9	7.5	9	15	18	18.5	20	22	23	30	28

Type IEC60947-4 Ratings	MC-65A		MC-75A		MC-85A		MC-100A		MC-130A		MC-150A		MC-185A	
	kW	A	kW	A	kW	A	kW	A	kW	A	kW	A	kW	A
AC-1	-	100	-	110	-	135	-	160	-	160	-	210	-	230
AC-3 200/240V	18.5	65	22	75	25	85	30	105	37	130	45	150	55	185
380/440V	30	65	37	75	45	85	55	105	60	130	75	150	90	185
500/550V	33	60	37	64	45	75	55	85	60	90	70	100	110	180
690V	33	35	37	42	45	45	45	65	55	60	55	60	110	120

Type IEC60947-4 Ratings	MC-225A		MC-265A		MC-330A		MC-400A		MC-500A		MC-630A		MC-800A	
	kW	A	kW	A	kW	A	kW	A	kW	A	kW	A	kW	A
AC-1	-	275	-	300	-	350	-	450	-	580	-	660	-	900
AC-3 200/240V	75	225	80	265	90	330	125	400	147	500	190	630	220	800
380/440V	132	225	147	265	160	330	200	400	265	500	330	630	440	800
500/550V	132	200	147	225	160	280	225	350	265	400	330	500	500	720
690V	140	150	160	185	200	225	250	300	300	380	400	420	500	630

We have a large line of Motor Protection Solutions

Circuit Protection Devices & Motor Disconnect Switches

Contact Altech Today!



Katko Motor Disconnect Switches



ABL UL508 Manual Motor Controllers,
UL489 Miniature Molded Case Circuit Breakers,
and UL1077 Supplementary Protectors



Altech's UL508 Manual Motor Controllers
UL489 Miniature Molded Case Circuit Breakers
and UL1077 Supplementary Protectors

PLUS

Molded Case Circuit Breakers, Three Phase
Adjustable Trip Miniature Circuit Breakers/
Manual Motor Controllers, Three Phase Adjustable Trip
Economy Manual Motor Controllers and Earth
Leakage Circuit Breakers

Mini Contactors



UL508
E108780



Mini Contactors

Type	6A	9A	12A
Number of Poles	3 NO main Contacts, 1 Auxiliary Contact		
Terminal Type	Screw Clamp	Screw Clamp	Screw Clamp
NEMA Size	00	00	00
Standard Auxiliary*	1NO	1NO	1NO

Coil Voltage	Frequency	Part. No.	Part. No.	Part. No.	
AC Coil	24V	50/60 Hz	GMC-6M-10-AC24V	GMC-9M-10-AC24V	GMC-12M-10-AC24V
	120V	50/60 Hz	GMC-6M-10-AC120V	GMC-9M-10-AC120V	GMC-12M-10-AC120V
	208V	60 Hz	GMC-6M-10-AC208V	GMC-9M-10-AC208V	GMC-12M-10-AC208V
	230V	50/60 Hz	GMC-6M-10-AC230V	GMC-9M-10-AC230V	GMC-12M-10-AC230V

Other AC Coil Voltages Available
50/ 60Hz:
42V, 48V,
110V, 220V,
277V, 400V,
480V, 600V

Coil Characteristics and Data

Pick-up Voltage Limit	80-110%
Drop-out Voltage Limit	30-40%
Coil Consumption (W)	2
Inrush [VA]	32
Holding [VA]	6
Closing Time [ms]	10...20
Opening Time [ms]	35...45

DC Coil	12V	-	GMD-6M-10-DC12V	GMD-9M-10-DC12V	GMD-12M-10-DC12V
	24V	-	GMD-6M-10-DC24V	GMD-9M-10-DC24V	GMD-12M-10-DC24V

Coil Characteristics and Data

Pick-up Voltage Limit	80-110%
Drop-out Voltage Limit	10-30%
Coil Consumption (W)	3
Inrush [W]	3
Holding [W]	3
Closing Time [ms]	40-50
Opening Time [ms]	35-45

HP Rating / UL508	HP	HP	HP
Continuous current	20A	20A	20A
Single phase			
110~120V	0.5	0.5	1
220~240V	1	1.5	2
Three phase			
240V	1.5	3	3
480V	3	5	7.5
600	3	5	10

Overload Relays

(Class 10A,
Differential Typical)



Setting Ranges (A)	Frame Size 22AF
0.1-0.16A	GTK-12M-0.16
0.16-0.25A	GTK-12M-0.25
0.25-0.4A	GTK-12M-0.4
0.4-0.63A	GTK-12M-0.63
0.63-1A	GTK-12M-1
1-1.6A	GTK-12M-1.6
1.6-2.5A	GTK-12M-2.5
2.4-4A	GTK-12M-4
4-6A	GTK-12M-6
5-8A	GTK-12M-8
6-9A	GTK-12M-9
7-10A	GTK-12M-10
9-13A	GTK-12M-13
12-16A	GTK-12M-16

* For built-in NC Auxiliary Switch change part number to -01; e.g. GMC-6M-01-AC24V.

Mini Contactors

Accessories

Altech Corp.[®]

Reversing Mini Contactor

Separate parts for assembling Reversing Contactors

For Pre-assembled Reversing Mini Contactors please consult Altech.

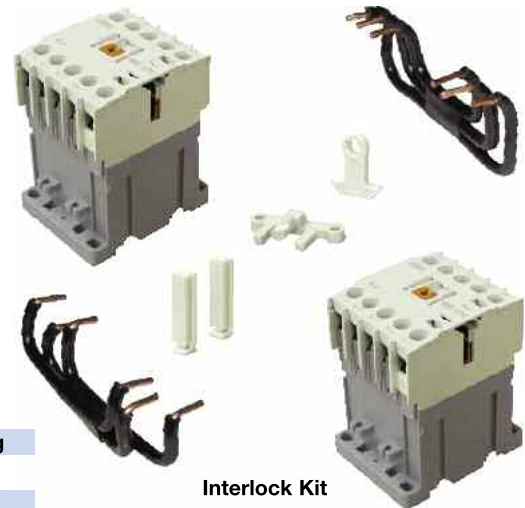

Interlock Kit

Interlock Kit

Part No.	Mini Contactor Type
AR-12M	6A - 12A

Auxiliary Contacts

Part No.	Poles	Configuration	Mounting
AU-1M-10	1	1NO	Side
AU-1M-01	1	1NC	Side
AU-2M-20	2	2NO	Front
AU-2M-02	2	2NC	Front
AU-2M-11	2	1NO/1NC	Front
AU-4M-40	4	4NO	Front
AU-4M-31	4	3NO/1NC	Front
AU-4M-22	4	2NO/2NC	Front
AU-4M-13	4	1NO/3NC	Front
AU-4M-04	4	4NC	Front

Surge Units

Part No.	Rated Voltage	Internal Element	Contactor Type
AS-12M/1	24-48VAC	Varistor	GMC-6M-12M
AS-12M/2	60-127VAC	Varistor	GMC-6M-12M
AS-12M/3	200-240VAC	Varistor	GMC-6M-12M
AS-12M/4	12-24VDC	Varistor	GMD-6M-12M
AS-12M/5	30-72VDC	Varistor	GMD-6M-12M
AS-12M/6	100-127VDC	Varistor	GMD-6M-12M
AS-12M/7	200-250VDC	Varistor	GMD-6M-12M

Base for Separate Mounting Overload Relay

Part No.
AZ-12MH

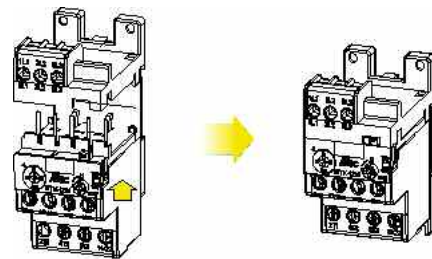

Specifications

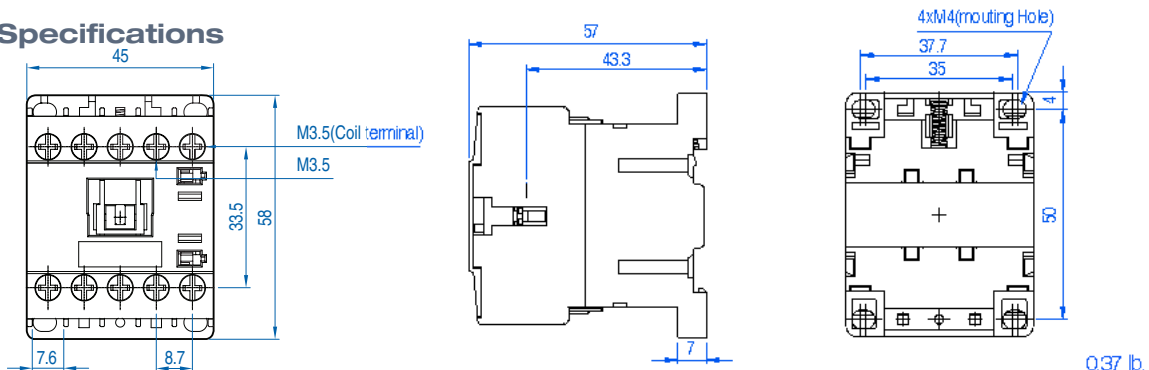

Dimensions in mm (to convert to inches multiply by 0.03937).