

Features

- High Performance, Low Power AVR® 8-bit Microcontroller
- Advanced RISC Architecture
 - 120 Powerful Instructions – Most Single Clock Cycle Execution
 - 32 x 8 General Purpose Working Registers
 - Fully Static Operation
- High Endurance, Non-volatile Memory Segments
 - 2K/4K/8K Bytes of In-System, Self-programmable Flash Program Memory
 - Endurance: 10,000 Write/Erase Cycles
 - 128/256/512 Bytes of In-System Programmable EEPROM
 - Endurance: 100,000 Write/Erase Cycles
 - 128/256/512 Bytes of Internal SRAM
 - Data Retention: 20 years at 85°C / 100 years at 25°C
 - Programming Lock for Self-programming Flash & EEPROM Data Security
- Peripheral Features
 - One 8-bit and One 16-bit Timer/Counter with Two PWM Channels, Each
 - 10-bit ADC
 - 8 Single-ended Channels
 - 12 Differential ADC Channel Pairs with Programmable Gain (1x / 20x)
 - Programmable Watchdog Timer with Separate On-chip Oscillator
 - On-chip Analog Comparator
 - Universal Serial Interface
- Special Microcontroller Features
 - debugWIRE On-chip Debug System
 - In-System Programmable via SPI Port
 - Internal and External Interrupt Sources
 - Pin Change Interrupt on 12 Pins
 - Low Power Idle, ADC Noise Reduction, Standby and Power-down Modes
 - Enhanced Power-on Reset Circuit
 - Programmable Brown-out Detection Circuit with Software Disable Function
 - Internal Calibrated Oscillator
 - On-chip Temperature Sensor
- I/O and Packages
 - Available in 20-pin QFN/MLF/VQFN, 14-pin SOIC, 14-pin PDIP and 15-ball UFBGA
 - Twelve Programmable I/O Lines
- Operating Voltage:
 - 1.8 – 5.5V
- Speed Grade:
 - 0 – 4 MHz @ 1.8 – 5.5V
 - 0 – 10 MHz @ 2.7 – 5.5V
 - 0 – 20 MHz @ 4.5 – 5.5V
- Industrial Temperature Range: -40°C to +85°C
- Low Power Consumption
 - Active Mode:
 - 210 µA at 1.8V and 1 MHz
 - Idle Mode:
 - 33 µA at 1.8V and 1 MHz
 - Power-down Mode:
 - 0.1 µA at 1.8V and 25°C



**8-bit AVR®
Microcontroller
with 2K/4K/8K
Bytes In-System
Programmable
Flash**

**ATtiny24A
ATtiny44A
ATtiny84A**

Summary

Rev. 8183FS-AVR-06/12



1. Pin Configurations

Figure 1-1. Pinout of ATtiny24A/44A/84A

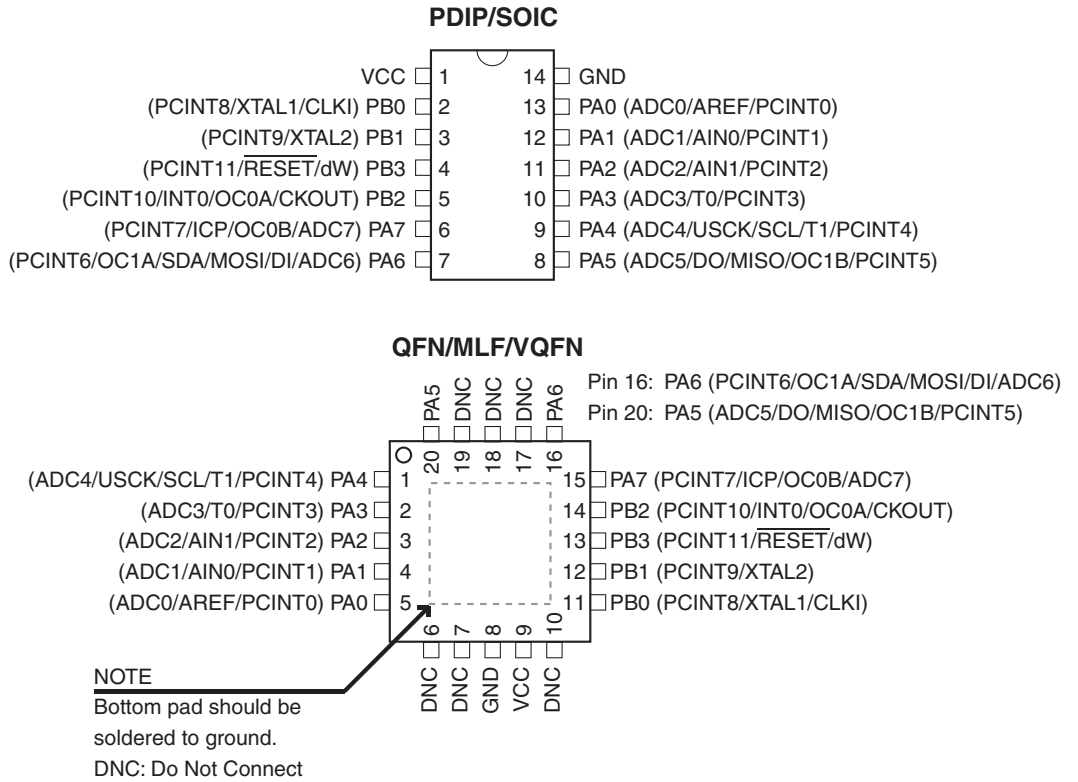

Table 1-1. UFBGA - Pinout ATtiny24A/44A/84A (top view)

| | 1 | 2 | 3 | 4 |
|---|-----|-----|-----|-----|
| A | | PA5 | PA6 | PB2 |
| B | PA4 | PA7 | PB1 | PB3 |
| C | PA3 | PA2 | PA1 | PB0 |
| D | PA0 | GND | GND | VCC |

1.1 Pin Descriptions

1.1.1 VCC

Supply voltage.

1.1.2 GND

Ground.

1.1.3 Port B (PB3:PB0)

Port B is a 4-bit bi-directional I/O port with internal pull-up resistors (selected for each bit). The Port B output buffers have symmetrical drive characteristics with both high sink and source capability except PB3 which has the $\overline{\text{RESET}}$ capability. To use pin PB3 as an I/O pin, instead of RESET pin, program ('0') RSTDISBL fuse. As inputs, Port B pins that are externally pulled low will source current if the pull-up resistors are activated. The Port B pins are tri-stated when a reset condition becomes active, even if the clock is not running.

Port B also serves the functions of various special features of the ATtiny24A/44A/84A as listed in [Section 10.2 "Alternate Port Functions" on page 58](#).

1.1.4 $\overline{\text{RESET}}$

Reset input. A low level on this pin for longer than the minimum pulse length will generate a reset, even if the clock is not running and provided the reset pin has not been disabled. The minimum pulse length is given in [Table 20-4 on page 176](#). Shorter pulses are not guaranteed to generate a reset.

The reset pin can also be used as a (weak) I/O pin.

1.1.5 Port A (PA7:PA0)

Port A is a 8-bit bi-directional I/O port with internal pull-up resistors (selected for each bit). The Port A output buffers have symmetrical drive characteristics with both high sink and source capability. As inputs, Port A pins that are externally pulled low will source current if the pull-up resistors are activated. The Port A pins are tri-stated when a reset condition becomes active, even if the clock is not running.

Port A has alternate functions as analog inputs for the ADC, analog comparator, timer/counter, SPI and pin change interrupt as described in ["Alternate Port Functions" on page 58](#).

2. Overview

ATtiny24A/44A/84A are low-power CMOS 8-bit microcontrollers based on the AVR enhanced RISC architecture. By executing powerful instructions in a single clock cycle, the ATtiny24A/44A/84A achieves throughputs approaching 1 MIPS per MHz allowing the system designer to optimize power consumption versus processing speed.

Figure 2-1. Block Diagram

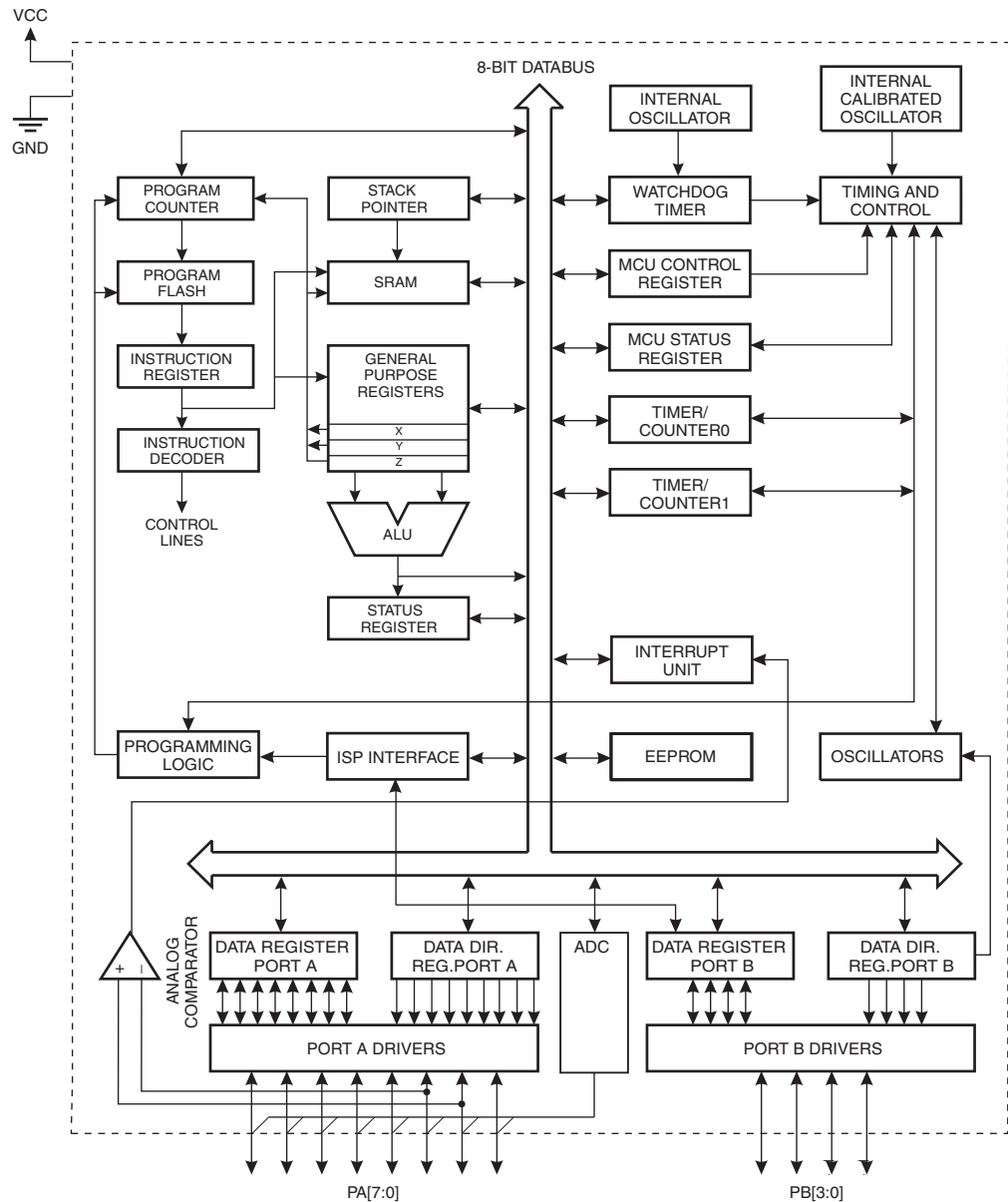

The AVR core combines a rich instruction set with 32 general purpose working registers. All 32 registers are directly connected to the Arithmetic Logic Unit (ALU), allowing two independent registers to be accessed in one single instruction executed in one clock cycle. The resulting architecture is more code efficient while achieving throughputs up to ten times faster than conventional CISC microcontrollers.

The ATtiny24A/44A/84A provides the following features: 2K/4K/8K byte of In-System Programmable Flash, 128/256/512 bytes EEPROM, 128/256/512 bytes SRAM, 12 general purpose I/O lines, 32 general purpose working registers, an 8-bit Timer/Counter with two PWM channels, a 16-bit timer/counter with two PWM channels, Internal and External Interrupts, a 8-channel 10-bit ADC, programmable gain stage (1x, 20x) for 12 differential ADC channel pairs, a programmable Watchdog Timer with internal oscillator, internal calibrated oscillator, and four software selectable power saving modes. Idle mode stops the CPU while allowing the SRAM, Timer/Counter, ADC, Analog Comparator, and Interrupt system to continue functioning. ADC Noise Reduction mode minimizes switching noise during ADC conversions by stopping the CPU and all I/O modules except the ADC. In Power-down mode registers keep their contents and all chip functions are disabled until the next interrupt or hardware reset. In Standby mode, the crystal/resonator oscillator is running while the rest of the device is sleeping, allowing very fast start-up combined with low power consumption.

The device is manufactured using Atmel's high density non-volatile memory technology. The on-chip ISP Flash allows the Program memory to be re-programmed in-system through an SPI serial interface, by a conventional non-volatile memory programmer or by an on-chip boot code running on the AVR core.

The ATtiny24A/44A/84A AVR is supported with a full suite of program and system development tools including: C Compilers, Macro Assemblers, Program Debugger/Simulators and Evaluation kits.

3. General Information

3.1 Resources

A comprehensive set of drivers, application notes, data sheets and descriptions on development tools are available for download at <http://www.atmel.com/avr>.

3.2 Code Examples

This documentation contains simple code examples that briefly show how to use various parts of the device. These code examples assume that the part specific header file is included before compilation. Be aware that not all C compiler vendors include bit definitions in the header files and interrupt handling in C is compiler dependent. Please confirm with the C compiler documentation for more details.

For I/O Registers located in the extended I/O map, “IN”, “OUT”, “SBIS”, “SBIC”, “CBI”, and “SBI” instructions must be replaced with instructions that allow access to extended I/O. Typically, this means “LDS” and “STS” combined with “SBRS”, “SBRC”, “SBR”, and “CBR”. Note that not all AVR devices include an extended I/O map.

3.3 Capacitive Touch Sensing

Atmel QTouch Library provides a simple to use solution for touch sensitive interfaces on Atmel AVR microcontrollers. The QTouch Library includes support for QTouch[®] and QMatrix[®] acquisition methods.

Touch sensing is easily added to any application by linking the QTouch Library and using the Application Programming Interface (API) of the library to define the touch channels and sensors. The application then calls the API to retrieve channel information and determine the state of the touch sensor.

The QTouch Library is free and can be downloaded from the Atmel website. For more information and details of implementation, refer to the QTouch Library User Guide – also available from the Atmel website.

3.4 Data Retention

Reliability Qualification results show that the projected data retention failure rate is much less than 1 PPM over 20 years at 85°C or 100 years at 25°C.

3.5 Disclaimer

Typical values contained in this datasheet are based on simulations and characterization of other AVR microcontrollers manufactured on the same process technology. Min and Max values will be available after the device has been characterized.

4. Register Summary

| Address | Name | Bit 7 | Bit 6 | Bit 5 | Bit 4 | Bit 3 | Bit 2 | Bit 1 | Bit 0 | Page |
|-------------|----------|---|--------|--------|--------|---------|---------|---------|---------|------------------|
| 0x3F (0x5F) | SREG | I | T | H | S | V | N | Z | C | Page 14 |
| 0x3E (0x5E) | SPH | – | – | – | – | – | – | SP9 | SP8 | Page 13 |
| 0x3D (0x5D) | SPL | SP7 | SP6 | SP5 | SP4 | SP3 | SP2 | SP1 | SP0 | Page 13 |
| 0x3C (0x5C) | OCR0B | Timer/Counter0 – Output Compare Register B | | | | | | | | Page 83 |
| 0x3B (0x5B) | GIMSK | – | INT0 | PCIE1 | PCIE0 | – | – | – | – | Page 50 |
| 0x3A (0x5A) | GIFR | – | INTF0 | PCIF1 | PCIF0 | – | – | – | – | Page 51 |
| 0x39 (0x59) | TIMSK0 | – | – | – | – | – | OCIE0B | OCIE0A | TOIE0 | Page 83 |
| 0x38 (0x58) | TIFR0 | – | – | – | – | – | OCF0B | OCF0A | TOV0 | Page 84 |
| 0x37 (0x57) | SPMCSR | – | – | RSIG | CTPB | RFLB | PGWRT | PGERS | SPMEN | Page 156 |
| 0x36 (0x56) | OCR0A | Timer/Counter0 – Output Compare Register A | | | | | | | | Page 83 |
| 0x35 (0x55) | MCUCR | BODS | PUD | SE | SM1 | SM0 | BODSE | ISC01 | ISC00 | Pages 36, 50, 66 |
| 0x34 (0x54) | MCUSR | – | – | – | – | WDRF | BORF | EXTRF | PORF | Page 44 |
| 0x33 (0x53) | TCCR0B | FOC0A | FOC0B | – | – | WGM02 | CS02 | CS01 | CS00 | Page 82 |
| 0x32 (0x52) | TCNT0 | Timer/Counter0 | | | | | | | | Page 83 |
| 0x31 (0x51) | OSCCAL | CAL7 | CAL6 | CAL5 | CAL4 | CAL3 | CAL2 | CAL1 | CAL0 | Page 31 |
| 0x30 (0x50) | TCCR0A | COM0A1 | COM0A0 | COM0B1 | COM0B0 | – | – | WGM01 | WGM00 | Page 79 |
| 0x2F (0x4F) | TCCR1A | COM1A1 | COM1A0 | COM1B1 | COM1B0 | – | – | WGM11 | WGM10 | Page 106 |
| 0x2E (0x4E) | TCCR1B | ICNC1 | ICES1 | – | WGM13 | WGM12 | CS12 | CS11 | CS10 | Page 108 |
| 0x2D (0x4D) | TCNT1H | Timer/Counter1 – Counter Register High Byte | | | | | | | | Page 110 |
| 0x2C (0x4C) | TCNT1L | Timer/Counter1 – Counter Register Low Byte | | | | | | | | Page 110 |
| 0x2B (0x4B) | OCR1AH | Timer/Counter1 – Compare Register A High Byte | | | | | | | | Page 110 |
| 0x2A (0x4A) | OCR1AL | Timer/Counter1 – Compare Register A Low Byte | | | | | | | | Page 110 |
| 0x29 (0x49) | OCR1BH | Timer/Counter1 – Compare Register B High Byte | | | | | | | | Page 110 |
| 0x28 (0x48) | OCR1BL | Timer/Counter1 – Compare Register B Low Byte | | | | | | | | Page 110 |
| 0x27 (0x47) | DWDR | DWDR[7:0] | | | | | | | | Page 151 |
| 0x26 (0x46) | CLKPR | CLKPCE | – | – | – | CLKPS3 | CLKPS2 | CLKPS1 | CLKPS0 | Page 31 |
| 0x25 (0x45) | ICR1H | Timer/Counter1 – Input Capture Register High Byte | | | | | | | | Page 111 |
| 0x24 (0x44) | ICR1L | Timer/Counter1 – Input Capture Register Low Byte | | | | | | | | Page 111 |
| 0x23 (0x43) | GTCCR | TSM | – | – | – | – | – | – | PSR10 | Page 114 |
| 0x22 (0x42) | TCCR1C | FOC1A | FOC1B | – | – | – | – | – | – | Page 109 |
| 0x21 (0x41) | WDTCR | WDIF | WDIE | WDP3 | WDCE | WDE | WDP2 | WDP1 | WDP0 | Page 44 |
| 0x20 (0x40) | PCMSK1 | – | – | – | – | PCINT11 | PCINT10 | PCINT9 | PCINT8 | Page 51 |
| 0x1F (0x3F) | EEARH | – | – | – | – | – | – | – | EEAR8 | Page 20 |
| 0x1E (0x3E) | EEARL | EEAR7 | EEAR6 | EEAR5 | EEAR4 | EEAR3 | EEAR2 | EEAR1 | EEAR0 | Page 21 |
| 0x1D (0x3D) | EEDR | EEPROM Data Register | | | | | | | | Page 21 |
| 0x1C (0x3C) | EEDR | – | – | EEM1 | EEM0 | EERIE | EEMPE | EEPE | EERE | Page 23 |
| 0x1B (0x3B) | PORTA | PORTA7 | PORTA6 | PORTA5 | PORTA4 | PORTA3 | PORTA2 | PORTA1 | PORTA0 | Page 66 |
| 0x1A (0x3A) | DDRA | DDA7 | DDA6 | DDA5 | DDA4 | DDA3 | DDA2 | DDA1 | DDA0 | Page 66 |
| 0x19 (0x39) | PINA | PINA7 | PINA6 | PINA5 | PINA4 | PINA3 | PINA2 | PINA1 | PINA0 | Page 67 |
| 0x18 (0x38) | PORTB | – | – | – | – | PORTB3 | PORTB2 | PORTB1 | PORTB0 | Page 67 |
| 0x17 (0x37) | DDRB | – | – | – | – | DDB3 | DDB2 | DDB1 | DDB0 | Page 67 |
| 0x16 (0x36) | PINB | – | – | – | – | PINB3 | PINB2 | PINB1 | PINB0 | Page 67 |
| 0x15 (0x35) | GPIOR2 | General Purpose I/O Register 2 | | | | | | | | Page 22 |
| 0x14 (0x34) | GPIOR1 | General Purpose I/O Register 1 | | | | | | | | Page 23 |
| 0x13 (0x33) | GPIOR0 | General Purpose I/O Register 0 | | | | | | | | Page 23 |
| 0x12 (0x32) | PCMSK0 | PCINT7 | PCINT6 | PCINT5 | PCINT4 | PCINT3 | PCINT2 | PCINT1 | PCINT0 | Page 52 |
| 0x11 (0x31) | Reserved | – | | | | | | | | |
| 0x10 (0x30) | USIBR | USI Buffer Register | | | | | | | | Page 127 |
| 0x0F (0x2F) | USIDR | USI Data Register | | | | | | | | Page 126 |
| 0x0E (0x2E) | USISR | USISIF | USIOIF | USIPF | USIDC | USICNT3 | USICNT2 | USICNT1 | USICNT0 | Page 125 |
| 0x0D (0x2D) | USICR | USISIE | USIOIE | USIWM1 | USIWM0 | USICS1 | USICS0 | USICLK | USITC | Page 123 |
| 0x0C (0x2C) | TIMSK1 | – | – | ICIE1 | – | – | OCIE1B | OCIE1A | TOIE1 | Page 111 |
| 0x0B (0x2B) | TIFR1 | – | – | ICF1 | – | – | OCF1B | OCF1A | TOV1 | Page 112 |
| 0x0A (0x2A) | Reserved | – | | | | | | | | |
| 0x09 (0x29) | Reserved | – | | | | | | | | |
| 0x08 (0x28) | ACSR | ACD | ACBG | ACO | ACI | ACIE | ACIC | ACIS1 | ACIS0 | Page 129 |
| 0x07 (0x27) | ADMUX | REFS1 | REFS0 | MUX5 | MUX4 | MUX3 | MUX2 | MUX1 | MUX0 | Page 144 |
| 0x06 (0x26) | ADCSRA | ADEN | ADSC | ADATE | ADIF | ADIE | ADPS2 | ADPS1 | ADPS0 | Page 146 |
| 0x05 (0x25) | ADCH | ADC Data Register High Byte | | | | | | | | Page 148 |
| 0x04 (0x24) | ADCL | ADC Data Register Low Byte | | | | | | | | Page 148 |
| 0x03 (0x23) | ADCSRB | BIN | ACME | – | ADLAR | – | ADTS2 | ADTS1 | ADTS0 | Pages 130, 148 |
| 0x02 (0x22) | Reserved | – | | | | | | | | |
| 0x01 (0x21) | DIDR0 | ADC7D | ADC6D | ADC5D | ADC4D | ADC3D | ADC2D | ADC1D | ADC0D | Pages 131, 149 |
| 0x00 (0x20) | PRR | – | – | – | – | PRTIM1 | PRTIM0 | PRUSI | PRADC | Page 37 |

- Note:
1. For compatibility with future devices, reserved bits should be written to zero if accessed. Reserved I/O memory addresses should never be written.
 2. I/O Registers within the address range 0x00 - 0x1F are directly bit-accessible using the SBI and CBI instructions. In these registers, the value of single bits can be checked by using the SBIS and SBIC instructions.
 3. Some of the Status Flags are cleared by writing a logical one to them. Note that, unlike most other AVRs, the CBI and SBI instructions will only operation the specified bit, and can therefore be used on registers containing such Status Flags. The CBI and SBI instructions work with registers 0x00 to 0x1F only.

5. Instruction Set Summary

| Mnemonics | Operands | Description | Operation | Flags | #Clocks |
|--|----------|--|--|---------------|---------|
| ARITHMETIC AND LOGIC INSTRUCTIONS | | | | | |
| ADD | Rd, Rr | Add two Registers | $Rd \leftarrow Rd + Rr$ | Z,C,N,V,H | 1 |
| ADC | Rd, Rr | Add with Carry two Registers | $Rd \leftarrow Rd + Rr + C$ | Z,C,N,V,H | 1 |
| ADIW | Rd,K | Add Immediate to Word | $Rdh:Rdl \leftarrow Rdh:Rdl + K$ | Z,C,N,V,S | 2 |
| SUB | Rd, Rr | Subtract two Registers | $Rd \leftarrow Rd - Rr$ | Z,C,N,V,H | 1 |
| SUBI | Rd, K | Subtract Constant from Register | $Rd \leftarrow Rd - K$ | Z,C,N,V,H | 1 |
| SBC | Rd, Rr | Subtract with Carry two Registers | $Rd \leftarrow Rd - Rr - C$ | Z,C,N,V,H | 1 |
| SBCI | Rd, K | Subtract with Carry Constant from Reg. | $Rd \leftarrow Rd - K - C$ | Z,C,N,V,H | 1 |
| SBIW | Rd,K | Subtract Immediate from Word | $Rdh:Rdl \leftarrow Rdh:Rdl - K$ | Z,C,N,V,S | 2 |
| AND | Rd, Rr | Logical AND Registers | $Rd \leftarrow Rd \bullet Rr$ | Z,N,V | 1 |
| ANDI | Rd, K | Logical AND Register and Constant | $Rd \leftarrow Rd \bullet K$ | Z,N,V | 1 |
| OR | Rd, Rr | Logical OR Registers | $Rd \leftarrow Rd \vee Rr$ | Z,N,V | 1 |
| ORI | Rd, K | Logical OR Register and Constant | $Rd \leftarrow Rd \vee K$ | Z,N,V | 1 |
| EOR | Rd, Rr | Exclusive OR Registers | $Rd \leftarrow Rd \oplus Rr$ | Z,N,V | 1 |
| COM | Rd | One's Complement | $Rd \leftarrow 0xFF - Rd$ | Z,C,N,V | 1 |
| NEG | Rd | Two's Complement | $Rd \leftarrow 0x00 - Rd$ | Z,C,N,V,H | 1 |
| SBR | Rd,K | Set Bit(s) in Register | $Rd \leftarrow Rd \vee K$ | Z,N,V | 1 |
| CBR | Rd,K | Clear Bit(s) in Register | $Rd \leftarrow Rd \bullet (0xFF - K)$ | Z,N,V | 1 |
| INC | Rd | Increment | $Rd \leftarrow Rd + 1$ | Z,N,V | 1 |
| DEC | Rd | Decrement | $Rd \leftarrow Rd - 1$ | Z,N,V | 1 |
| TST | Rd | Test for Zero or Minus | $Rd \leftarrow Rd \bullet Rd$ | Z,N,V | 1 |
| CLR | Rd | Clear Register | $Rd \leftarrow Rd \oplus Rd$ | Z,N,V | 1 |
| SER | Rd | Set Register | $Rd \leftarrow 0xFF$ | None | 1 |
| BRANCH INSTRUCTIONS | | | | | |
| RJMP | k | Relative Jump | $PC \leftarrow PC + k + 1$ | None | 2 |
| IJMP | | Indirect Jump to (Z) | $PC \leftarrow Z$ | None | 2 |
| RCALL | k | Relative Subroutine Call | $PC \leftarrow PC + k + 1$ | None | 3 |
| ICALL | | Indirect Call to (Z) | $PC \leftarrow Z$ | None | 3 |
| RET | | Subroutine Return | $PC \leftarrow STACK$ | None | 4 |
| RETI | | Interrupt Return | $PC \leftarrow STACK$ | I | 4 |
| CPSE | Rd,Rr | Compare, Skip if Equal | if (Rd = Rr) $PC \leftarrow PC + 2$ or 3 | None | 1/2/3 |
| CP | Rd,Rr | Compare | $Rd - Rr$ | Z, N, V, C, H | 1 |
| CPC | Rd,Rr | Compare with Carry | $Rd - Rr - C$ | Z, N, V, C, H | 1 |
| CPI | Rd,K | Compare Register with Immediate | $Rd - K$ | Z, N, V, C, H | 1 |
| SBRC | Rr, b | Skip if Bit in Register Cleared | if (Rr(b)=0) $PC \leftarrow PC + 2$ or 3 | None | 1/2/3 |
| SBRS | Rr, b | Skip if Bit in Register is Set | if (Rr(b)=1) $PC \leftarrow PC + 2$ or 3 | None | 1/2/3 |
| SBIC | P, b | Skip if Bit in I/O Register Cleared | if (P(b)=0) $PC \leftarrow PC + 2$ or 3 | None | 1/2/3 |
| SBIS | P, b | Skip if Bit in I/O Register is Set | if (P(b)=1) $PC \leftarrow PC + 2$ or 3 | None | 1/2/3 |
| BRBS | s, k | Branch if Status Flag Set | if (SREG(s) = 1) then $PC \leftarrow PC + k + 1$ | None | 1/2 |
| BRBC | s, k | Branch if Status Flag Cleared | if (SREG(s) = 0) then $PC \leftarrow PC + k + 1$ | None | 1/2 |
| BREQ | k | Branch if Equal | if (Z = 1) then $PC \leftarrow PC + k + 1$ | None | 1/2 |
| BRNE | k | Branch if Not Equal | if (Z = 0) then $PC \leftarrow PC + k + 1$ | None | 1/2 |
| BRCS | k | Branch if Carry Set | if (C = 1) then $PC \leftarrow PC + k + 1$ | None | 1/2 |
| BRCC | k | Branch if Carry Cleared | if (C = 0) then $PC \leftarrow PC + k + 1$ | None | 1/2 |
| BRSH | k | Branch if Same or Higher | if (C = 0) then $PC \leftarrow PC + k + 1$ | None | 1/2 |
| BRLO | k | Branch if Lower | if (C = 1) then $PC \leftarrow PC + k + 1$ | None | 1/2 |
| BRMI | k | Branch if Minus | if (N = 1) then $PC \leftarrow PC + k + 1$ | None | 1/2 |
| BRPL | k | Branch if Plus | if (N = 0) then $PC \leftarrow PC + k + 1$ | None | 1/2 |
| BRGE | k | Branch if Greater or Equal, Signed | if (N \oplus V = 0) then $PC \leftarrow PC + k + 1$ | None | 1/2 |
| BRLT | k | Branch if Less Than Zero, Signed | if (N \oplus V = 1) then $PC \leftarrow PC + k + 1$ | None | 1/2 |
| BRHS | k | Branch if Half Carry Flag Set | if (H = 1) then $PC \leftarrow PC + k + 1$ | None | 1/2 |
| BRHC | k | Branch if Half Carry Flag Cleared | if (H = 0) then $PC \leftarrow PC + k + 1$ | None | 1/2 |
| BRTS | k | Branch if T Flag Set | if (T = 1) then $PC \leftarrow PC + k + 1$ | None | 1/2 |
| BRTC | k | Branch if T Flag Cleared | if (T = 0) then $PC \leftarrow PC + k + 1$ | None | 1/2 |
| BRVS | k | Branch if Overflow Flag is Set | if (V = 1) then $PC \leftarrow PC + k + 1$ | None | 1/2 |
| BRVC | k | Branch if Overflow Flag is Cleared | if (V = 0) then $PC \leftarrow PC + k + 1$ | None | 1/2 |
| BRIE | k | Branch if Interrupt Enabled | if (I = 1) then $PC \leftarrow PC + k + 1$ | None | 1/2 |
| BRID | k | Branch if Interrupt Disabled | if (I = 0) then $PC \leftarrow PC + k + 1$ | None | 1/2 |
| BIT AND BIT-TEST INSTRUCTIONS | | | | | |
| SBI | P,b | Set Bit in I/O Register | $I/O(P,b) \leftarrow 1$ | None | 2 |
| CBI | P,b | Clear Bit in I/O Register | $I/O(P,b) \leftarrow 0$ | None | 2 |
| LSL | Rd | Logical Shift Left | $Rd(n+1) \leftarrow Rd(n), Rd(0) \leftarrow 0$ | Z,C,N,V | 1 |
| LSR | Rd | Logical Shift Right | $Rd(n) \leftarrow Rd(n+1), Rd(7) \leftarrow 0$ | Z,C,N,V | 1 |
| ROL | Rd | Rotate Left Through Carry | $Rd(0) \leftarrow C, Rd(n+1) \leftarrow Rd(n), C \leftarrow Rd(7)$ | Z,C,N,V | 1 |

| Mnemonics | Operands | Description | Operation | Flags | #Clocks |
|-----------------------------------|----------|----------------------------------|--|---------|---------|
| ROR | Rd | Rotate Right Through Carry | $Rd(7) \leftarrow C, Rd(n) \leftarrow Rd(n+1), C \leftarrow Rd(0)$ | Z,C,N,V | 1 |
| ASR | Rd | Arithmetic Shift Right | $Rd(n) \leftarrow Rd(n+1), n=0..6$ | Z,C,N,V | 1 |
| SWAP | Rd | Swap Nibbles | $Rd(3..0) \leftarrow Rd(7..4), Rd(7..4) \leftarrow Rd(3..0)$ | None | 1 |
| BSET | s | Flag Set | $SREG(s) \leftarrow 1$ | SREG(s) | 1 |
| BCLR | s | Flag Clear | $SREG(s) \leftarrow 0$ | SREG(s) | 1 |
| BST | Rr, b | Bit Store from Register to T | $T \leftarrow Rr(b)$ | T | 1 |
| BLD | Rd, b | Bit load from T to Register | $Rd(b) \leftarrow T$ | None | 1 |
| SEC | | Set Carry | $C \leftarrow 1$ | C | 1 |
| CLC | | Clear Carry | $C \leftarrow 0$ | C | 1 |
| SEN | | Set Negative Flag | $N \leftarrow 1$ | N | 1 |
| CLN | | Clear Negative Flag | $N \leftarrow 0$ | N | 1 |
| SEZ | | Set Zero Flag | $Z \leftarrow 1$ | Z | 1 |
| CLZ | | Clear Zero Flag | $Z \leftarrow 0$ | Z | 1 |
| SEI | | Global Interrupt Enable | $I \leftarrow 1$ | I | 1 |
| CLI | | Global Interrupt Disable | $I \leftarrow 0$ | I | 1 |
| SES | | Set Signed Test Flag | $S \leftarrow 1$ | S | 1 |
| CLS | | Clear Signed Test Flag | $S \leftarrow 0$ | S | 1 |
| SEV | | Set Twos Complement Overflow | $V \leftarrow 1$ | V | 1 |
| CLV | | Clear Twos Complement Overflow | $V \leftarrow 0$ | V | 1 |
| SET | | Set T in SREG | $T \leftarrow 1$ | T | 1 |
| CLT | | Clear T in SREG | $T \leftarrow 0$ | T | 1 |
| SEH | | Set Half Carry Flag in SREG | $H \leftarrow 1$ | H | 1 |
| CLH | | Clear Half Carry Flag in SREG | $H \leftarrow 0$ | H | 1 |
| DATA TRANSFER INSTRUCTIONS | | | | | |
| MOV | Rd, Rr | Move Between Registers | $Rd \leftarrow Rr$ | None | 1 |
| MOVW | Rd, Rr | Copy Register Word | $Rd+1:Rd \leftarrow Rr+1:Rr$ | None | 1 |
| LDI | Rd, K | Load Immediate | $Rd \leftarrow K$ | None | 1 |
| LD | Rd, X | Load Indirect | $Rd \leftarrow (X)$ | None | 2 |
| LD | Rd, X+ | Load Indirect and Post-Inc. | $Rd \leftarrow (X), X \leftarrow X + 1$ | None | 2 |
| LD | Rd, -X | Load Indirect and Pre-Dec. | $X \leftarrow X - 1, Rd \leftarrow (X)$ | None | 2 |
| LD | Rd, Y | Load Indirect | $Rd \leftarrow (Y)$ | None | 2 |
| LD | Rd, Y+ | Load Indirect and Post-Inc. | $Rd \leftarrow (Y), Y \leftarrow Y + 1$ | None | 2 |
| LD | Rd, -Y | Load Indirect and Pre-Dec. | $Y \leftarrow Y - 1, Rd \leftarrow (Y)$ | None | 2 |
| LDD | Rd, Y+q | Load Indirect with Displacement | $Rd \leftarrow (Y + q)$ | None | 2 |
| LD | Rd, Z | Load Indirect | $Rd \leftarrow (Z)$ | None | 2 |
| LD | Rd, Z+ | Load Indirect and Post-Inc. | $Rd \leftarrow (Z), Z \leftarrow Z + 1$ | None | 2 |
| LD | Rd, -Z | Load Indirect and Pre-Dec. | $Z \leftarrow Z - 1, Rd \leftarrow (Z)$ | None | 2 |
| LDD | Rd, Z+q | Load Indirect with Displacement | $Rd \leftarrow (Z + q)$ | None | 2 |
| LDS | Rd, k | Load Direct from SRAM | $Rd \leftarrow (k)$ | None | 2 |
| ST | X, Rr | Store Indirect | $(X) \leftarrow Rr$ | None | 2 |
| ST | X+, Rr | Store Indirect and Post-Inc. | $(X) \leftarrow Rr, X \leftarrow X + 1$ | None | 2 |
| ST | -X, Rr | Store Indirect and Pre-Dec. | $X \leftarrow X - 1, (X) \leftarrow Rr$ | None | 2 |
| ST | Y, Rr | Store Indirect | $(Y) \leftarrow Rr$ | None | 2 |
| ST | Y+, Rr | Store Indirect and Post-Inc. | $(Y) \leftarrow Rr, Y \leftarrow Y + 1$ | None | 2 |
| ST | -Y, Rr | Store Indirect and Pre-Dec. | $Y \leftarrow Y - 1, (Y) \leftarrow Rr$ | None | 2 |
| STD | Y+q, Rr | Store Indirect with Displacement | $(Y + q) \leftarrow Rr$ | None | 2 |
| ST | Z, Rr | Store Indirect | $(Z) \leftarrow Rr$ | None | 2 |
| ST | Z+, Rr | Store Indirect and Post-Inc. | $(Z) \leftarrow Rr, Z \leftarrow Z + 1$ | None | 2 |
| ST | -Z, Rr | Store Indirect and Pre-Dec. | $Z \leftarrow Z - 1, (Z) \leftarrow Rr$ | None | 2 |
| STD | Z+q, Rr | Store Indirect with Displacement | $(Z + q) \leftarrow Rr$ | None | 2 |
| STS | k, Rr | Store Direct to SRAM | $(k) \leftarrow Rr$ | None | 2 |
| LPM | | Load Program Memory | $R0 \leftarrow (Z)$ | None | 3 |
| LPM | Rd, Z | Load Program Memory | $Rd \leftarrow (Z)$ | None | 3 |
| LPM | Rd, Z+ | Load Program Memory and Post-Inc | $Rd \leftarrow (Z), Z \leftarrow Z + 1$ | None | 3 |
| SPM | | Store Program Memory | $(z) \leftarrow R1:R0$ | None | |
| IN | Rd, P | In Port | $Rd \leftarrow P$ | None | 1 |
| OUT | P, Rr | Out Port | $P \leftarrow Rr$ | None | 1 |
| PUSH | Rr | Push Register on Stack | $STACK \leftarrow Rr$ | None | 2 |
| POP | Rd | Pop Register from Stack | $Rd \leftarrow STACK$ | None | 2 |
| MCU CONTROL INSTRUCTIONS | | | | | |
| NOP | | No Operation | | None | 1 |
| SLEEP | | Sleep | (see specific descr. for Sleep function) | None | 1 |
| WDR | | Watchdog Reset | (see specific descr. for WDR/Timer) | None | 1 |
| BREAK | | Break | For On-chip Debug Only | None | N/A |

6. Ordering Information

6.1 ATtiny24A

| Speed (MHz) ⁽¹⁾ | Supply Voltage (V) | Temperature Range | Package ⁽²⁾ | Ordering Code ⁽³⁾ |
|----------------------------|--------------------|--|-------------------------------|------------------------------|
| 20 | 1.8 – 5.5V | Industrial (-40°C to +85°C) ⁽⁵⁾ | 14S1 | ATtiny24A-SSU |
| | | | | ATtiny24A-SSUR |
| | | | 14P3 | ATtiny24A-PU |
| | | | 15CC1 | ATtiny24A-CCU |
| | | | | ATtiny24A-CCUR |
| | | | 20M1 | ATtiny24A-MU |
| | | ATtiny24A-MUR | | |
| | | 20M2 | ATtiny24A-MMH ⁽⁴⁾ | |
| | | | ATtiny24A-MMHR ⁽⁴⁾ | |
| | | Industrial (-40°C to +105°C) ⁽⁶⁾ | 14S1 | ATtiny24A-SSN |
| | | | | ATtiny24A-SSNR |
| | | Industrial (-40°C to +125°C) ⁽⁷⁾ | 14S1 | ATtiny24A-SSF |
| | | | | ATtiny24A-SSFR |
| | | | 20M1 | ATtiny24A-MF |
| ATtiny24A-MFR | | | | |
| 20M2 | ATtiny24A-MM8 | | | |
| | ATtiny24A-MM8R | | | |

- Notes:
- For speed vs. supply voltage, see section [20.3 "Speed" on page 174](#).
 - All packages are Pb-free, halide-free and fully green and they comply with the European directive for Restriction of Hazardous Substances (RoHS)
 - Code indicators:
 - H: NiPdAu lead finish
 - F, N, U: matte tin
 - R: tape & reel
 - Topside marking for ATtiny24A: T24 / Axx / manufacturing data
 - Also supplied in wafer form. Contact your local Atmel sales office for ordering information and minimum quantities.
 - For typical and electrical characteristics, see "Appendix A – ATtiny24A/44A Specification at 105°C".
 - For typical and electrical characteristics, see "Appendix B – ATtiny24A/44A/84A Specification at 125°C".

| Package Type | |
|--------------|--|
| 14S1 | 14-lead, 0.150" Wide Body, Plastic Gull Wing Small Outline Package (SOIC) |
| 14P3 | 14-lead, 0.300" Wide, Plastic Dual Inline Package (PDIP) |
| 15CC1 | 15-ball (4 x 4 Array), 0.65 mm Pitch, 3.0 x 3.0 x 0.6 mm, Ultra Thin, Fine-Pitch Ball Grid Array Package (UFBGA) |
| 20M1 | 20-pad, 4 x 4 x 0.8 mm Body, Quad Flat No Lead / Micro Lead Frame Package (QFN/MLF) |
| 20M2 | 20-pad, 3 x 3 x 0.85 mm Body, Very Thin Quad Flat No Lead Package (VQFN) |

6.2 ATtiny44A

| Speed (MHz) ⁽¹⁾ | Supply Voltage (V) | Temperature Range | Package ⁽²⁾ | Ordering Code ⁽³⁾ |
|----------------------------|--------------------|--|-------------------------------|------------------------------|
| 20 | 1.8 – 5.5V | Industrial (-40°C to +85°C) ⁽⁵⁾ | 14S1 | ATtiny44A-SSU |
| | | | | ATtiny44A-SSUR |
| | | | 14P3 | ATtiny44A-PU |
| | | | 15CC1 | ATtiny44A-CCU |
| | | | | ATtiny44A-CCUR |
| | | | 20M1 | ATtiny44A-MU |
| | | ATtiny44A-MUR | | |
| | | 20M2 | ATtiny44A-MMH ⁽⁴⁾ | |
| | | | ATtiny44A-MMHR ⁽⁴⁾ | |
| | | Industrial (-40°C to +105°C) ⁽⁶⁾ | 14S1 | ATtiny44A-SSN |
| | | | | ATtiny44A-SSNR |
| | | Industrial (-40°C to +125°C) ⁽⁷⁾ | 14S1 | ATtiny44A-SSF |
| ATtiny44A-SSFR | | | | |
| 20M1 | ATtiny44A-MF | | | |
| | ATtiny44A-MFR | | | |

- Notes:
- For speed vs. supply voltage, see section [20.3 “Speed” on page 174](#).
 - All packages are Pb-free, halide-free and fully green and they comply with the European directive for Restriction of Hazardous Substances (RoHS).
 - Code indicators:
 - H: NiPdAu lead finish
 - F, N, U: matte tin
 - R: tape & reel
 - Topside marking for ATtiny44A:
 - 1st Line: T44
 - 2nd Line: Axx
 - 3rd Line: manufacturing data
 - These devices can also be supplied in wafer form. Please contact your local Atmel sales office for detailed ordering information and minimum quantities.
 - For typical and electrical characteristics, see “Appendix A – ATtiny24A/44A Specification at 105°C”.
 - For typical and electrical characteristics, see “Appendix B – ATtiny24A/44A/84A Specification at 125°C”.

| Package Type | |
|--------------|--|
| 14S1 | 14-lead, 0.150" Wide Body, Plastic Gull Wing Small Outline Package (SOIC) |
| 14P3 | 14-lead, 0.300" Wide, Plastic Dual Inline Package (PDIP) |
| 15CC1 | 15-ball (4 x 4 Array), 0.65 mm Pitch, 3.0 x 3.0 x 0.6 mm, Ultra Thin, Fine-Pitch Ball Grid Array Package (UFBGA) |
| 20M1 | 20-pad, 4 x 4 x 0.8 mm Body, Quad Flat No Lead / Micro Lead Frame Package (QFN/MLF) |
| 20M2 | 20-pad, 3 x 3 x 0.85 mm Body, Very Thin Quad Flat No Lead Package (VQFN) |

6.3 ATtiny84A

| Speed (MHz) ⁽¹⁾ | Supply Voltage (V) | Temperature Range | Package ⁽²⁾ | Ordering Code ⁽³⁾ |
|----------------------------|--------------------|--|-------------------------------|------------------------------|
| 20 | 1.8 – 5.5V | Industrial (-40°C to +85°C) ⁽⁵⁾ | 14S1 | ATtiny84A-SSU |
| | | | | ATtiny84A-SSUR |
| | | | 14P3 | ATtiny84A-PU |
| | | | 15CC1 | ATtiny84A-CCU |
| | | | | ATtiny84A-CCUR |
| | | | 20M1 | ATtiny84A-MU |
| | | ATtiny84A-MUR | | |
| | | 20M2 | ATtiny84A-MMH ⁽⁴⁾ | |
| | | | ATtiny84A-MMHR ⁽⁴⁾ | |
| | | Industrial (-40°C to +125°C) ⁽⁷⁾ | 14S1 | ATtiny84A-SSF |
| ATtiny84A-SSFR | | | | |

- Notes:
- For speed vs. supply voltage, see section [20.3 "Speed" on page 174](#).
 - All packages are Pb-free, halide-free and fully green and they comply with the European directive for Restriction of Hazardous Substances (RoHS).
 - Code indicators:
 - H: NiPdAu lead finish
 - F, N, U: matte tin
 - R: tape & reel
 - Topside marking for ATtiny84A:
 - 1st Line: T84
 - 2nd Line: Axx
 - 3rd Line: manufacturing data
 - These devices can also be supplied in wafer form. Please contact your local Atmel sales office for detailed ordering information and minimum quantities.
 - For typical and electrical characteristics, see "Appendix A – ATtiny24A/44A Specification at 105°C".
 - For typical and electrical characteristics, see "Appendix B – ATtiny24A/44A/84A Specification at 125°C".

| Package Type | |
|--------------|--|
| 14S1 | 14-lead, 0.150" Wide Body, Plastic Gull Wing Small Outline Package (SOIC) |
| 14P3 | 14-lead, 0.300" Wide, Plastic Dual Inline Package (PDIP) |
| 15CC1 | 15-ball (4 x 4 Array), 0.65 mm Pitch, 3.0 x 3.0 x 0.6 mm, Ultra Thin, Fine-Pitch Ball Grid Array Package (UFBGA) |
| 20M1 | 20-pad, 4 x 4 x 0.8 mm Body, Quad Flat No Lead / Micro Lead Frame Package (QFN/MLF) |
| 20M2 | 20-pad, 3 x 3 x 0.85 mm Body, Very Thin Quad Flat No Lead Package (VQFN) |

7. Packaging Information

7.1 14S1

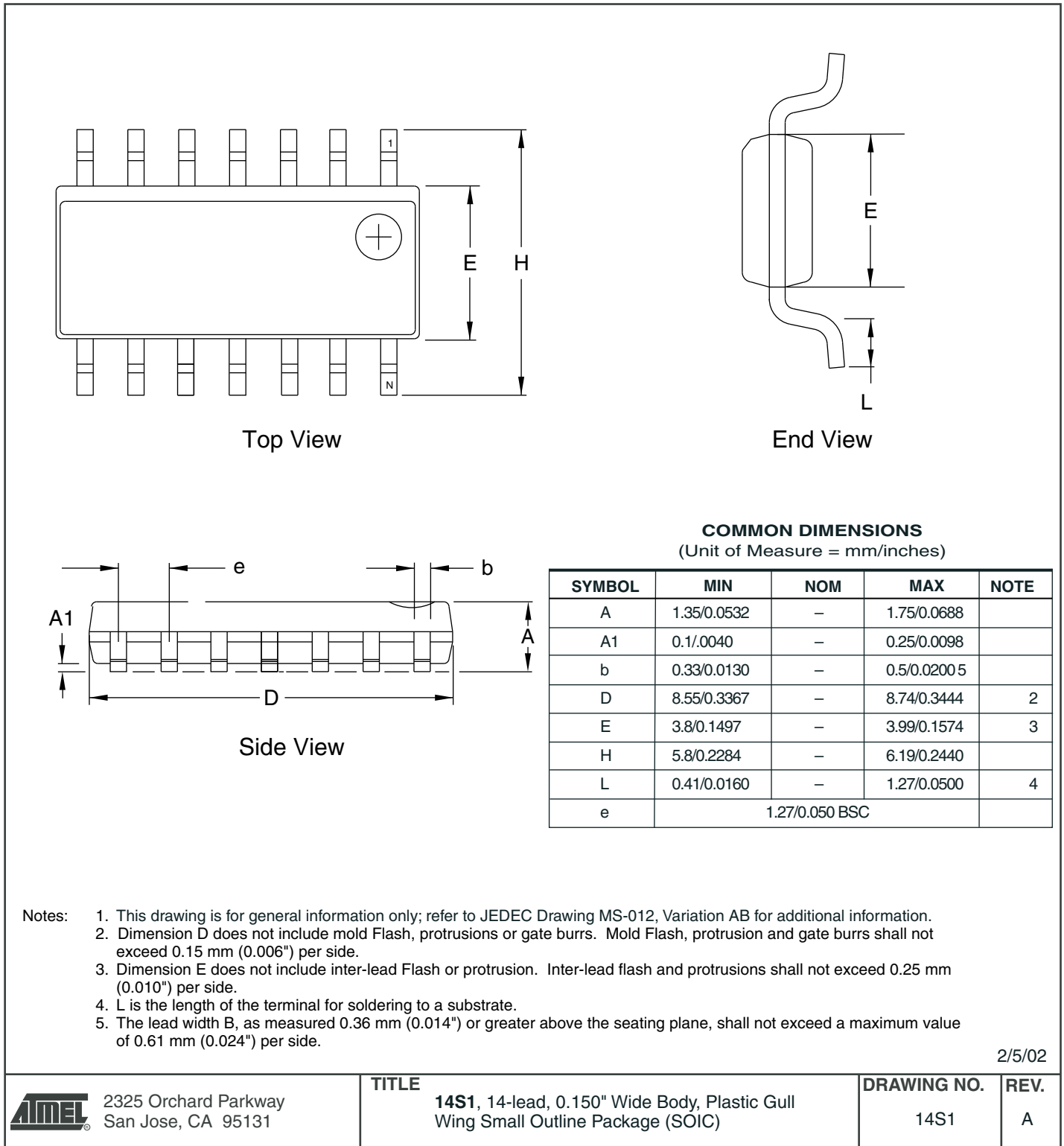

7.2 14P3

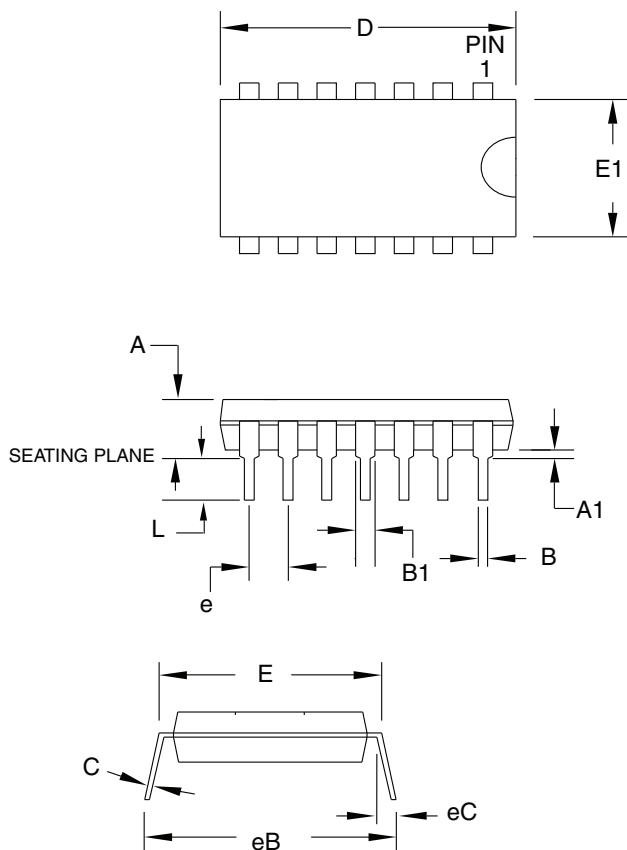

COMMON DIMENSIONS
(Unit of Measure = mm)

| SYMBOL | MIN | NOM | MAX | NOTE |
|--------|-----------|-----|--------|--------|
| A | – | – | 5.334 | |
| A1 | 0.381 | – | – | |
| D | 18.669 | – | 19.685 | Note 2 |
| E | 7.620 | – | 8.255 | |
| E1 | 6.096 | – | 7.112 | Note 2 |
| B | 0.356 | – | 0.559 | |
| B1 | 1.143 | – | 1.778 | |
| L | 2.921 | – | 3.810 | |
| C | 0.203 | – | 0.356 | |
| eB | – | – | 10.922 | |
| eC | 0.000 | – | 1.524 | |
| e | 2.540 TYP | | | |

- Notes: 1. This package conforms to JEDEC reference MS-001, Variation AA.
2. Dimensions D and E1 do not include mold Flash or Protrusion. Mold Flash or Protrusion shall not exceed 0.25 mm (0.010").

2010-10-20



2325 Orchard Parkway
San Jose, CA 95131

TITLE

14P3, 14-lead (0.300"/7.62 mm Wide) Plastic Dual In-line Package (PDIP)

DRAWING NO.

14P3

REV.

B



7.3 15CC1

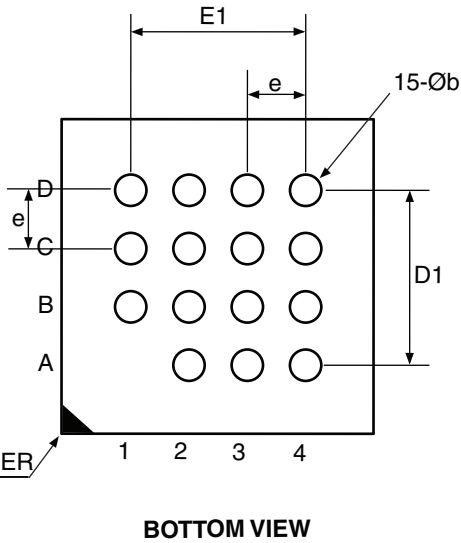
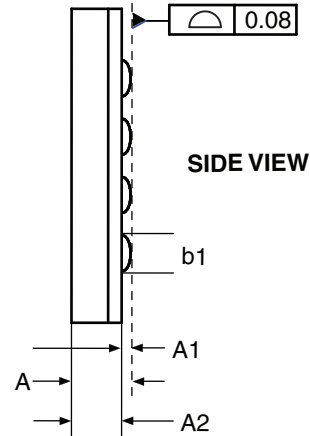
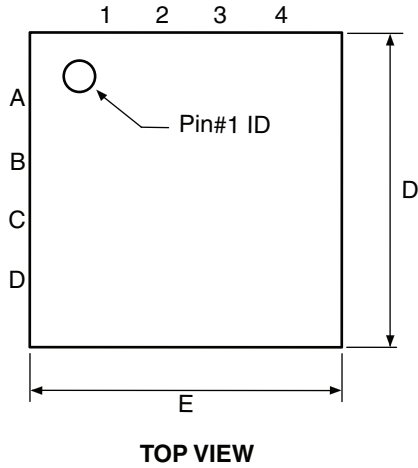

COMMON DIMENSIONS
(Unit of Measure = mm)

| SYMBOL | MIN | NOM | MAX | NOTE |
|--------|----------|------|------|------|
| A | – | – | 0.60 | |
| A1 | 0.12 | – | – | |
| A2 | 0.38 REF | | | |
| b | 0.25 | 0.30 | 0.35 | 1 |
| b1 | 0.25 | – | – | 2 |
| D | 2.90 | 3.00 | 3.10 | |
| D1 | 1.95 BSC | | | |
| E | 2.90 | 3.00 | 3.10 | |
| E1 | 1.95 BSC | | | |
| e | 0.65 BSC | | | |

Note1: Dimension “b” is measured at the maximum ball dia. in a plane parallel to the seating plane.

Note2: Dimension “b1” is the solderable surface defined by the opening of the solder resist layer.

07/06/10



Package Drawing Contact:
packagedrawings@atmel.com

TITLE

15CC1, 15-ball (4 x 4 Array), 3.0 x 3.0 x 0.6 mm package, ball pitch 0.65 mm, Ultra thin, Fine-Pitch Ball Grid Array Package (UFBGA)

GPC

CBC

DRAWING NO.

15CC1

REV.

C

7.4 20M1

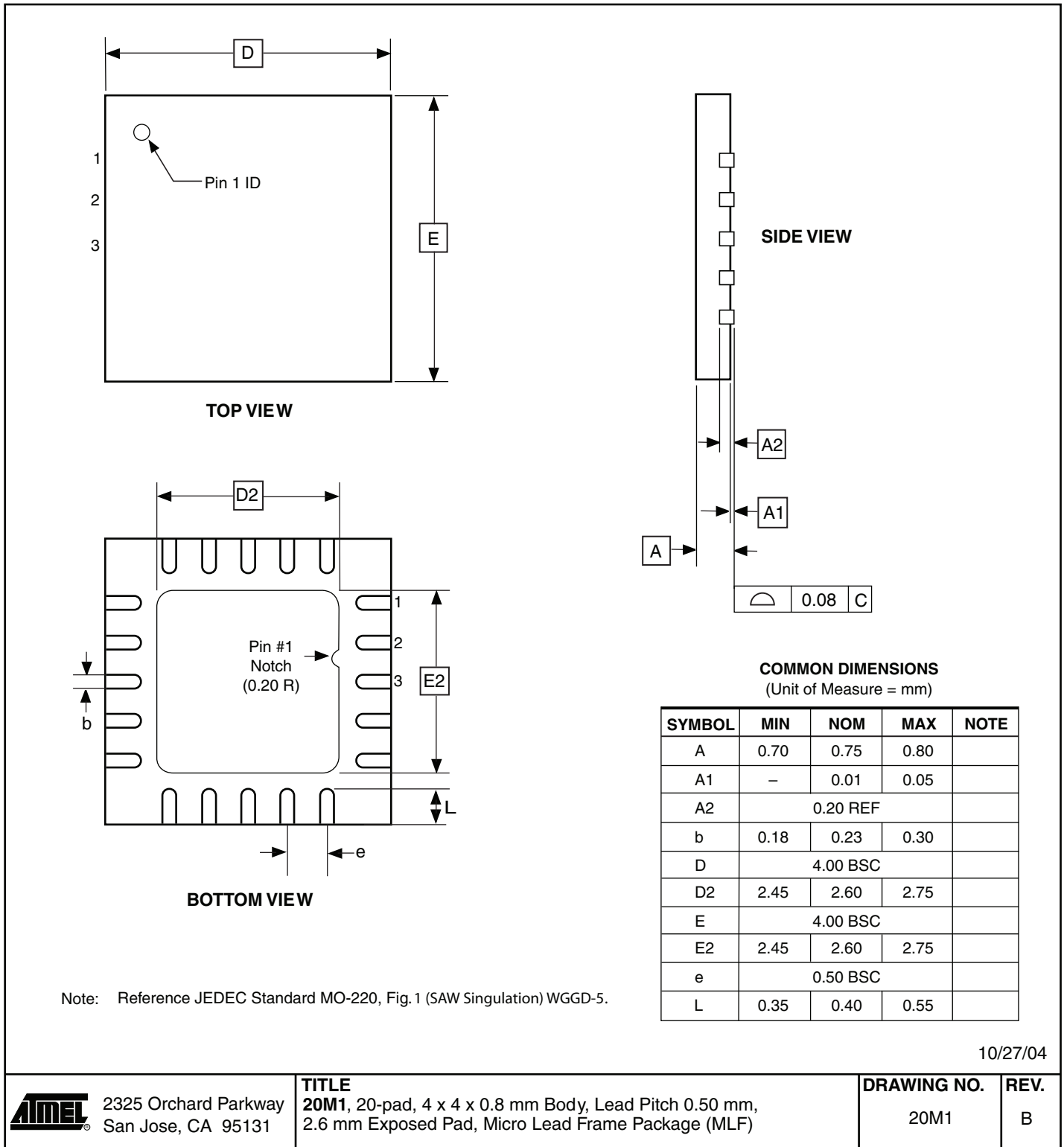

10/27/04



2325 Orchard Parkway
San Jose, CA 95131

TITLE

20M1, 20-pad, 4 x 4 x 0.8 mm Body, Lead Pitch 0.50 mm,
2.6 mm Exposed Pad, Micro Lead Frame Package (MLF)

DRAWING NO.

20M1

REV.

B



7.5 20M2

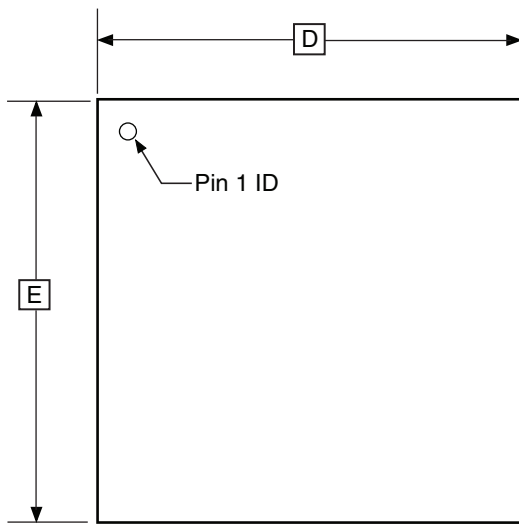

TOP VIEW

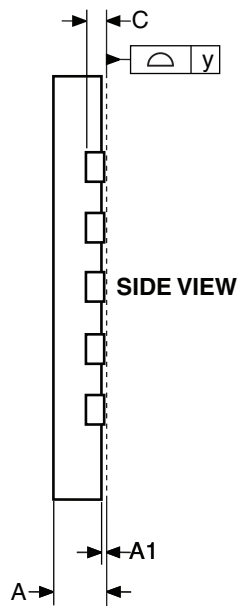

SIDE VIEW

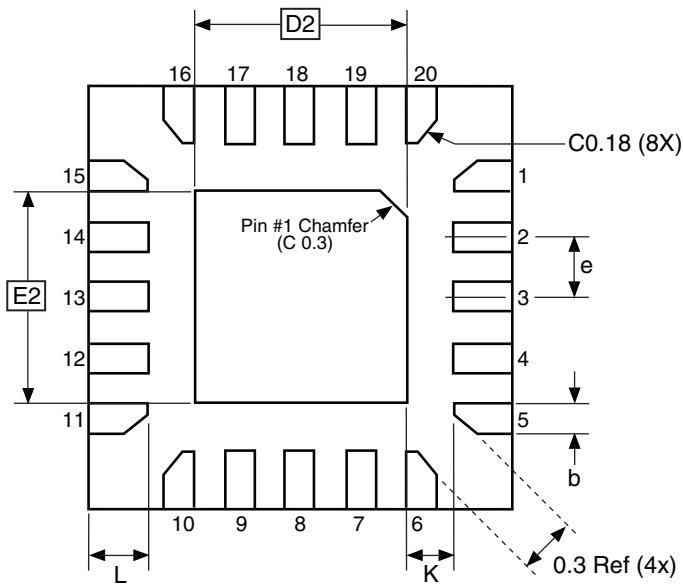

BOTTOM VIEW

COMMON DIMENSIONS
(Unit of Measure = mm)

| SYMBOL | MIN | NOM | MAX | NOTE |
|--------|-------|------|------|------|
| A | 0.75 | 0.80 | 0.85 | |
| A1 | 0.00 | 0.02 | 0.05 | |
| b | 0.17 | 0.22 | 0.27 | |
| C | 0.152 | | | |
| D | 2.90 | 3.00 | 3.10 | |
| D2 | 1.40 | 1.55 | 1.70 | |
| E | 2.90 | 3.00 | 3.10 | |
| E2 | 1.40 | 1.55 | 1.70 | |
| e | - | 0.45 | - | |
| L | 0.35 | 0.40 | 0.45 | |
| K | 0.20 | - | - | |
| y | 0.00 | - | 0.08 | |

10/24/08



Package Drawing Contact:
packagedrawings@atmel.com

TITLE
20M2, 20-pad, 3 x 3 x 0.85 mm Body, Lead Pitch 0.45 mm,
1.55 x 1.55 mm Exposed Pad, Thermally Enhanced
Plastic Very Thin Quad Flat No Lead Package (VQFN)

GPC
ZFC

DRAWING NO.
20M2

REV.
B

8. Errata

The revision letters in this section refer to the revision of the corresponding ATtiny24A/44A/84A device.

8.1 ATtiny24A

8.1.1 Rev. H

No known errata.

8.1.2 Rev. G

Not sampled.

8.1.3 Rev. F

Not sampled.

8.2 ATtiny44A

8.2.1 Rev. G

No known errata. Yield improvement.

8.2.2 Rev. F

No known errata.

8.2.3 Rev. E

Not sampled.

8.3 ATtiny84A

8.3.1 Rev. C

No known errata.

9. Datasheet Revision History

9.1 Rev. 8183F – 06/12

1. Updated:
 - [Table 16-1 on page 138](#)
 - [Figure 16-7 on page 137](#)
 - [“Ordering Information” on page 11](#)

9.2 Rev. 8183E – 01/12

1. Updated:
 - Production status for ATtiny24A and ATtiny84A
 - [“Start Condition Detector” on page 122](#)
 - [“Ordering Information” on page 11, 12, and 13](#)

9.3 Rev. 8183D – 04/11

1. Added errata for ATtiny44A rev. G in [Section 8. “Errata” on page 19](#)

9.4 Rev. 8183C – 03/11

1. Added:
 - ATtiny84A, including typical characteristics plots
 - [Section 3.3 “Capacitive Touch Sensing” on page 6](#)
 - [Table 6-8, “Capacitance of Low-Frequency Crystal Oscillator,” on page 28](#)
 - Analog Comparator Offset plots for ATtiny24A ([Figure 21.2.10 on page 208](#)) and ATtiny44A ([Figure 21.3.11 on page 236](#))
 - Extended temperature part numbers in [Section 6. “Ordering Information” on page 11](#)
2. Updated:
 - Bit syntax throughout the datasheet, e.g. from CS02:0 to CS0[2:0]
 - [Section 6.4 “Clock Output Buffer” on page 30](#), changed CLKO to CKOUT
 - [Table 16-4, “Single-Ended Input channel Selections,” on page 145](#), added note for Internal 1.1V Reference
 - [Table 19-16, “High-voltage Serial Programming Instruction Set for ATtiny24A/44A/84A,” on page 170](#), adjusted notes
 - [Table 20-1, “DC Characteristics. TA = -40°C to +85°C,” on page 173](#), adjusted notes

9.5 Rev. 8183B – 03/10

1. Updated template.
2. Added UFBGA package (15CC1) in: [“Features” on page 1](#), [“Pin Configurations” on page 2](#), [Section 6. “Ordering Information” on page 11](#), and [Section 7.3 “15CC1” on page 16](#).
3. Separated typical characteristic plots, added [Section 21.2 “ATtiny24A” on page 183](#).
4. Updated sections:
 - [Section 14.5.4 “USIBR – USI Buffer Register” on page 127](#), header updated

- Section 6. “Ordering Information” on page 11, added tape & reel and topside marking, updated notes
- 5. Updated Figures:
 - Figure 4-1 “Block Diagram of the AVR Architecture” on page 7
 - Figure 8-1 “Reset Logic” on page 38
 - Figure 14-1 “Universal Serial Interface, Block Diagram” on page 116, USIDB -> USIBR
 - Figure 19-5 “High-voltage Serial Programming Waveforms” on page 169
- 6. Updated Tables:
 - Table 19-11, “Minimum Wait Delay Before Writing the Next Flash or EEPROM Location,” on page 164, updated value for t_{WD_ERASE}

9.6 Rev. 8183A – 12/08

1. Initial revision. Created from document 8006H.
2. Updated "Ordering Information" on page 19 and page 19. Pb-plated packages are no longer offered and there are no separate ordering codes for commercial operation range, the only available option now is industrial. Also, updated some order codes to reflect changes in leadframe composition and added VQFN package option.
3. Updated data sheet template.
4. Removed all references to 8K device.
5. Updated characteristic plots of section “Typical Characteristics”, starting on page 182.
6. Added characteristic plots:
 - “Bandgap Voltage vs. Supply Voltage” on page 233
 - “Bandgap Voltage vs. Temperature” on page 233
7. Updated sections:
 - “Features” on page 1
 - “Power Reduction Register” on page 35
 - “Analog Comparator” on page 128
 - “Features” on page 132
 - “Operation” on page 133
 - “Starting a Conversion” on page 134
 - “ADC Voltage Reference” on page 139
 - “Speed” on page 174
8. Updated Figures:
 - “Program Memory Map” on page 15
 - “Data Memory Map” on page 16
9. Update Tables:
 - “Device Signature Bytes” on page 161
 - “DC Characteristics. TA = -40°C to +85°C” on page 173
 - “Additional Current Consumption for the different I/O modules (absolute values)” on page 182
 - “Additional Current Consumption (percentage) in Active and Idle mode” on page 183



Headquarters

Atmel Corporation

2325 Orchard Parkway
San Jose, CA 95131
USA
Tel: (+1)(408) 441-0311
Fax: (+1)(408) 487-2600

International

Atmel Asia Limited

Unit 01-5 & 16, 19F
BEA Tower, Millennium City 5
418 Kwun Tong Road
Kwun Tong, Kowloon
HONG KONG
Tel: (+852) 2245-6100
Fax: (+852) 2722-1369

Atmel Munich GmbH

Business Campus
Parking 4
D-85748 Garching b. Munich
GERMANY
Tel: (+49) 89-31970-0
Fax: (+49) 89-3194621

Atmel Japan

9F, Tonetsu Shinkawa Bldg.
1-24-8 Shinkawa
Chuo-ku, Tokyo 104-0033
JAPAN
Tel: (+81)(3) 3523-3551
Fax: (+81)(3) 3523-7581

Product Contact

Web Site

www.atmel.com

Technical Support

avr@atmel.com

Sales Contact

www.atmel.com/contacts

Literature Requests

www.atmel.com/literature

Disclaimer: The information in this document is provided in connection with Atmel products. No license, express or implied, by estoppel or otherwise, to any intellectual property right is granted by this document or in connection with the sale of Atmel products. **EXCEPT AS SET FORTH IN ATMEL'S TERMS AND CONDITIONS OF SALE LOCATED ON ATMEL'S WEB SITE, ATMEL ASSUMES NO LIABILITY WHATSOEVER AND DISCLAIMS ANY EXPRESS, IMPLIED OR STATUTORY WARRANTY RELATING TO ITS PRODUCTS INCLUDING, BUT NOT LIMITED TO, THE IMPLIED WARRANTY OF MERCHANTABILITY, FITNESS FOR A PARTICULAR PURPOSE, OR NON-INFRINGEMENT. IN NO EVENT SHALL ATMEL BE LIABLE FOR ANY DIRECT, INDIRECT, CONSEQUENTIAL, PUNITIVE, SPECIAL OR INCIDENTAL DAMAGES (INCLUDING, WITHOUT LIMITATION, DAMAGES FOR LOSS OF PROFITS, BUSINESS INTERRUPTION, OR LOSS OF INFORMATION) ARISING OUT OF THE USE OR INABILITY TO USE THIS DOCUMENT, EVEN IF ATMEL HAS BEEN ADVISED OF THE POSSIBILITY OF SUCH DAMAGES.** Atmel makes no representations or warranties with respect to the accuracy or completeness of the contents of this document and reserves the right to make changes to specifications and product descriptions at any time without notice. Atmel does not make any commitment to update the information contained herein. Unless specifically provided otherwise, Atmel products are not suitable for, and shall not be used in, automotive applications. Atmel's products are not intended, authorized, or warranted for use as components in applications intended to support or sustain life.

© 2012 Atmel Corporation. All rights reserved.

Atmel®, logo and combinations thereof, and others are registered trademarks or trademarks of Atmel Corporation or its subsidiaries. Other terms and product names may be trademarks of others.