

MTP IGBT Power Module Primary Dual Forward

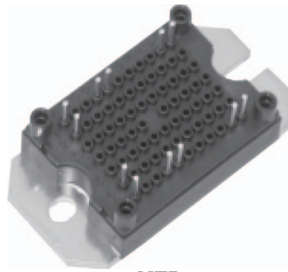

MTP
(Package example)

FEATURES

- Buck PFC stage with warp 3 IGBT and FRED Pt® hyperfast diode
- Integrated thermistor
- Isolated baseplate
- Very low stray inductance design for high speed operation
- Ultrafast switching IGBT
- Designed and qualified for industrial level
- Material categorization: for definitions of compliance please see www.vishay.com/doc?99912



RoHS
COMPLIANT

PRODUCT SUMMARY	
IGBT, T_J = 150 °C	
V _{CES}	600 V
V _{CE(ON)} at 25 °C at 80 A	2.11 V
I _C at 80 °C	96 A
FRED Pt® AP DIODE, T_J = 150 °C	
V _{RRM}	600 V
I _{F(DC)} at 80 °C	11 A
V _F at 25 °C at 5 A	1.1 V
FRED Pt® CHOPPER DIODE, T_J = 150 °C	
V _R	600 V
I _{F(DC)} at 80 °C	22 A
V _F at 25 °C at 60 A	2.07 V
Speed	30 kHz to 150 kHz
Package	MTP
Circuit	Dual forward

BENEFITS

- Lower conduction losses and switching losses
- Optimized for welding, UPS, and SMPS applications
- PCB solderable terminals
- Direct mounting to heatsink

ABSOLUTE MAXIMUM RATINGS					
	PARAMETER	SYMBOL	TEST CONDITIONS	MAX.	UNITS
IGBT	Collector to emitter voltage	V _{CES}		600	V
	Gate to emitter voltage	V _{GE}		± 20	V
	Maximum continuous collector current at V _{GE} = 15 V, T _J = 150 °C maximum	I _C	T _C = 25 °C	138	A
			T _C = 80 °C	96	
	Pulse collector current	I _{CM} ⁽¹⁾		330	
	Clamped inductive load current	I _{LM}		330	
Maximum power dissipation	P _D	T _C = 25 °C	543	W	
Antiparallel Diode	Repetitive peak reverse voltage	V _{RRM}		600	V
	Maximum continuous forward current T _J = 150 °C maximum	I _{F(DC)}	T _C = 25 °C	17	A
			T _C = 80 °C	11	
	Maximum non-repetitive peak current	I _{FSM}	10 ms sine or 6 ms rectangular pulse, T _J = 25 °C	60	
Maximum power dissipation	P _D	T _C = 25 °C	24	W	



ABSOLUTE MAXIMUM RATINGS					
	PARAMETER	SYMBOL	TEST CONDITIONS	MAX.	UNITS
Chopper Diode	Repetitive peak reverse voltage	V_{RRM}		600	V
	Maximum continuous forward current $T_J = 150\text{ }^\circ\text{C}$ maximum	I_F	$T_C = 25\text{ }^\circ\text{C}$	33	A
			$T_C = 80\text{ }^\circ\text{C}$	22	
	Maximum non-repetitive peak current	I_{FSM}	10 ms sine or 6 ms rectangular pulse, $T_J = 25\text{ }^\circ\text{C}$	135	
Maximum power dissipation	P_D	$T_C = 25\text{ }^\circ\text{C}$	57	W	
	Maximum operating junction temperature	T_J		150	$^\circ\text{C}$
	Storage temperature range	T_{Stg}		-40 to +150	
	Isolation voltage	V_{ISOL}	$T_J = 25\text{ }^\circ\text{C}$, all terminals shorted, $f = 50\text{ Hz}$, $t = 1\text{ s}$	3500	V

Notes

- Absolute maximum ratings indicate sustained limits beyond which damage to the device may occur.
- (1) $V_{CC} = 300\text{ V}$, $V_{GE} = 15\text{ V}$, $L = 500\text{ }\mu\text{H}$, $R_g = 4.7\text{ }\Omega$, $T_J = 150\text{ }^\circ\text{C}$

ELECTRICAL SPECIFICATIONS ($T_J = 25\text{ }^\circ\text{C}$ unless otherwise noted)							
	PARAMETER	SYMBOL	TEST CONDITIONS	MIN.	TYP.	MAX.	UNITS
IGBT	Collector to emitter breakdown voltage	BV_{CES}	$V_{GE} = 0\text{ V}$, $I_C = 1.5\text{ mA}$	600	-	-	V
	Temperature coefficient of breakdown voltage	$\Delta V_{BR(CES)}/\Delta T_J$	$I_C = 1.0\text{ mA}$ ($25\text{ }^\circ\text{C}$ to $125\text{ }^\circ\text{C}$)	-	0.6	-	$\text{V}/^\circ\text{C}$
	Collector to emitter voltage	$V_{CE(ON)}$	$V_{GE} = 15\text{ V}$, $I_C = 80\text{ A}$	-	2.11	2.48	V
			$V_{GE} = 15\text{ V}$, $I_C = 80\text{ A}$, $T_J = 125\text{ }^\circ\text{C}$	-	2.43	-	
	Gate threshold voltage	$V_{GE(th)}$	$V_{CE} = V_{GE}$, $I_C = 750\text{ }\mu\text{A}$	3.2	4.4	6.2	V
	Temperature coefficient of threshold voltage	$\Delta V_{GE(th)}/\Delta T_J$	$V_{CE} = V_{GE}$, $I_C = 1.0\text{ mA}$ ($25\text{ }^\circ\text{C}$ to $125\text{ }^\circ\text{C}$)	-	-12	-	$\text{mV}/^\circ\text{C}$
	Forward transconductance	g_{fe}	$V_{CE} = 20\text{ V}$, $I_C = 80\text{ A}$	-	97	-	S
	Transfer characteristics	V_{GE}	$V_{CE} = 20\text{ V}$, $I_C = 80\text{ A}$	-	6.6	-	V
	Collector to emitter leakage current	I_{CES}	$V_{GE} = 0\text{ V}$, $V_{CE} = 600\text{ V}$	-	8	100	μA
$V_{GE} = 0\text{ V}$, $V_{CE} = 600\text{ V}$, $T_J = 125\text{ }^\circ\text{C}$			-	0.1	-	mA	
Gate to emitter leakage	I_{GES}	$V_{GE} = \pm 20\text{ V}$	-	-	± 250	nA	
AP Diode	Blocking voltage	BV_{RRM}	$I_R = 100\text{ }\mu\text{A}$	600	-	-	V
	Forward voltage drop	V_{FM}	$I_F = 5\text{ A}$	-	1.1	1.27	V
$I_F = 5\text{ A}$, $T_J = 125\text{ }^\circ\text{C}$			-	0.96	-		
Chopper Diode	Forward voltage drop	V_{FM}	$I_F = 60\text{ A}$	-	2.07	2.53	V
			$I_F = 60\text{ A}$, $T_J = 125\text{ }^\circ\text{C}$	-	1.87	-	
	Blocking voltage	BV_{RM}	$I_R = 100\text{ }\mu\text{A}$	600	-	-	
	Reverse leakage current	I_{RM}	$V_{RRM} = 600\text{ V}$	-	2	70	μA
$V_{RRM} = 600\text{ V}$, $T_J = 125\text{ }^\circ\text{C}$			-	12	-		



SWITCHING CHARACTERISTICS (T _J = 25 °C unless otherwise noted)							
	PARAMETER	SYMBOL	TEST CONDITIONS	MIN.	TYP.	MAX.	UNITS
PFC IGBT	Total gate charge (turn-on)	Q _g	I _C = 60 A V _{CC} = 400 V V _{GE} = 15 V	-	540	-	nC
	Gate to emitter charge (turn-on)	Q _{ge}		-	84	-	
	Gate to collector charge (turn-on)	Q _{gc}		-	192	-	
	Turn-on switching loss	E _{on}	I _C = 150 A, V _{CC} = 300 V, V _{GE} = 15 V, R _g = 4.7 Ω, L = 500 μH, T _J = 25 °C ⁽¹⁾	-	0.51	-	mJ
	Turn-off switching loss	E _{off}		-	2.66	-	
	Total switching loss	E _{tot}		-	3.17	-	
	Turn-on delay time	t _{d(on)}		-	173	-	ns
	Rise time	t _r		-	79	-	
	Turn-off delay time	t _{d(off)}		-	374	-	
	Fall time	t _f	-	66	-		
	Turn-on switching loss	E _{on}	I _C = 150 A, V _{CC} = 300 V, V _{GE} = 15 V, R _g = 4.7 Ω, L = 500 μH, T _J = 125 °C ⁽¹⁾	-	0.66	-	mJ
	Turn-off switching loss	E _{off}		-	2.75	-	
	Total switching loss	E _{tot}		-	3.41	-	
	Turn-on delay time	t _{d(on)}		-	167	-	ns
	Rise time	t _r		-	80	-	
	Turn-off delay time	t _{d(off)}		-	389	-	
	Fall time	t _f	-	69	-		
	Input capacitance	C _{ies}	V _{GE} = 0 V V _{CC} = 30 V f = 1 MHz	-	14 020	-	pF
	Output capacitance	C _{oes}		-	1010	-	
	Reverse transfer capacitance	C _{res}		-	174	-	
Reverse bias safe operating area	RBSOA	I _C = 330 A, V _{CC} = 300 V, V _P = 600 V, R _g = 4.7 Ω, V _{GE} = 15 V, L = 500 μH, T _J = 150 °C	Full square				

Note

⁽¹⁾ Energy losses include “tail” and diode reverse recovery.

RECOVERY PARAMETER (T _J = 25 °C unless otherwise noted)							
	PARAMETER	SYMBOL	TEST CONDITIONS	MIN.	TYP.	MAX.	UNITS
AP Diode	Peak reverse recovery current	I _{rr}	I _F = 10 A di/dt = 200 A/μs V _{rr} = 200 V	-	10	-	A
	Reverse recovery time	t _{rr}		-	104	-	ns
	Reverse recovery charge	Q _{rr}		-	537	-	nC
Chopper Diode	Peak reverse recovery current	I _{rr}	I _F = 50 A di/dt = 200 A/μs V _{rr} = 200 V	-	4.7	-	A
	Reverse recovery time	t _{rr}		-	73	-	ns
	Reverse recovery charge	Q _{rr}		-	171	-	nC
	Peak reverse recovery current	I _{rr}	I _F = 50 A di/dt = 200 A/μs V _{rr} = 200 V, T _J = 125 °C	-	10.3	-	A
	Reverse recovery time	t _{rr}		-	140	-	ns
	Reverse recovery charge	Q _{rr}		-	716	-	nC

THERMISTOR ELECTRICAL CHARACTERISTICS (T _J = 25 °C unless otherwise noted)						
PARAMETER	SYMBOL	TEST CONDITIONS	MIN.	TYP.	MAX.	UNITS
Resistance	R	T _J = 25 °C	-	30 000	-	Ω
B value	B	T _J = 25 °C/T _J = 85 °C	-	4000	-	K



THERMAL AND MECHANICAL SPECIFICATIONS						
	PARAMETER	SYMBOL	MIN.	TYP.	MAX.	UNITS
IGBT	Junction to case IGBT thermal resistance		-	-	0.23	
AP FRED Pt	Junction to case diode thermal resistance	R _{thJC}	-	-	5.1	°C/W
FRED Pt	Junction to case diode thermal resistance		-	-	2.2	
	Case to sink, flat, greased surface per module	R _{thCS}	-	0.06	-	°C/W
	Mounting torque ± 10 % to heatsink ⁽¹⁾		-	-	4	Nm
	Approximate weight		-	65	-	g

Note

⁽¹⁾ A mounting compound is recommended and the torque should be rechecked after a period of 3 hours to allow for the spread of the compound.

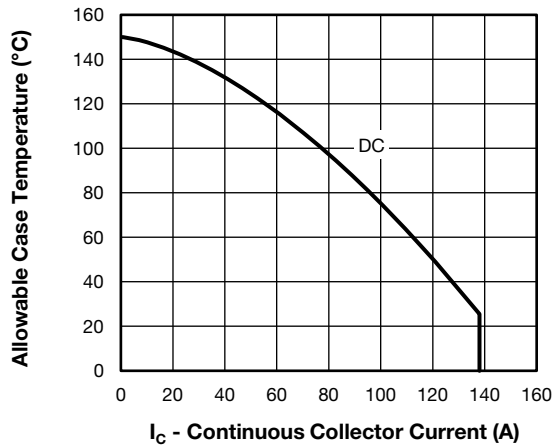

Fig. 1 - Allowable Case Temperature vs. Continuous Collector Current (Maximum IGBT Continuous Collector Current vs. Case Temperature)

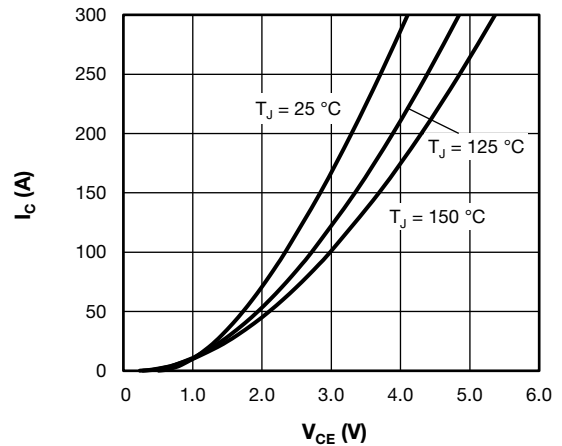

Fig. 3 - I_c vs. V_{CE} (Typical IGBT Output Characteristics, V_{GE} = 15 V)

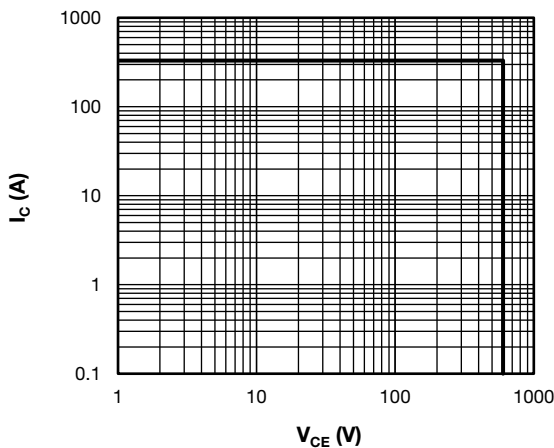

Fig. 2 - I_c vs. V_{CE} (IGBT Reverse BIAS SOA, T_J = 150 °C, V_{GE} = 15 V)

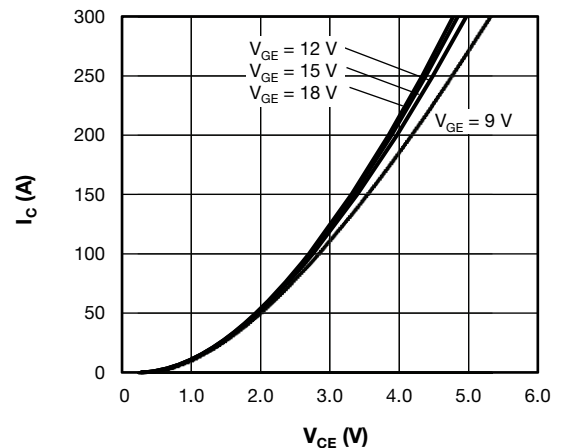

Fig. 4 - I_c vs. V_{CE} (Typical IGBT Output Characteristics, T_J = 125 °C)

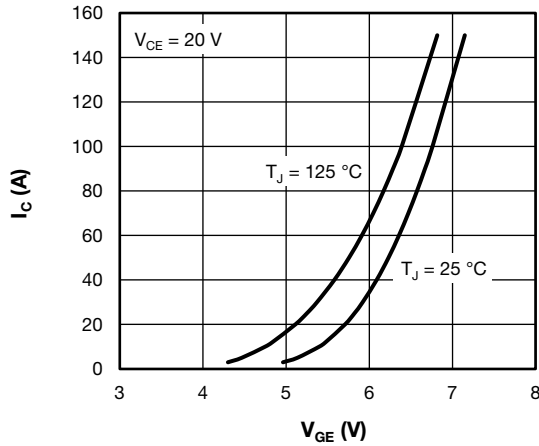

Fig. 5 - I_C vs. V_{GE}
(Typical IGBT Transfer Characteristics)

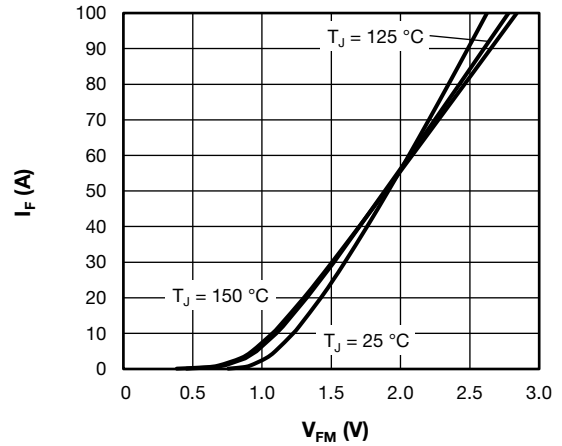

Fig. 8 - I_F vs. V_{FM}
(Typical Antiparallel Diode Forward Characteristics)

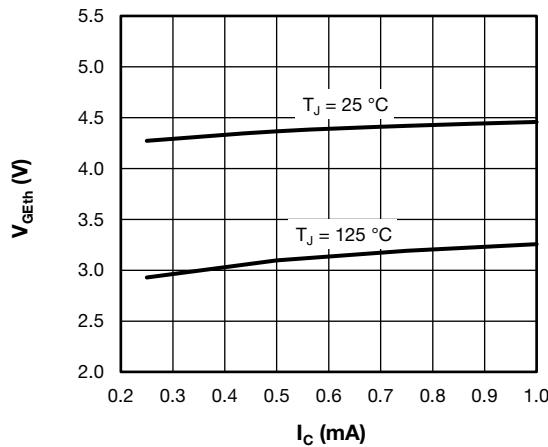

Fig. 6 - V_{GEth} vs. I_C
(Typical IGBT Gate Threshold Voltage)

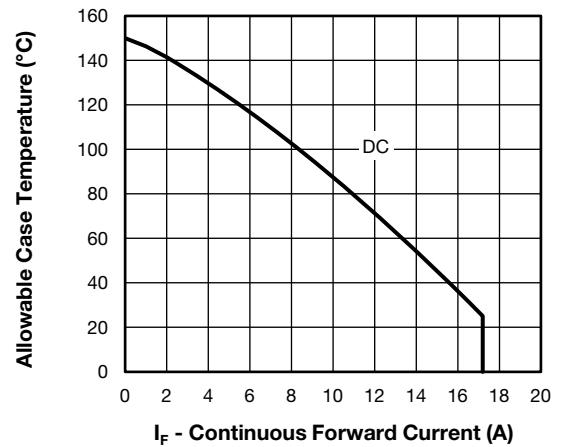

Fig. 9 - Allowable Case Temperature vs. Continuous Forward Current (Maximum Antiparallel Diode Continuous Forward Current vs. Case Temperature)

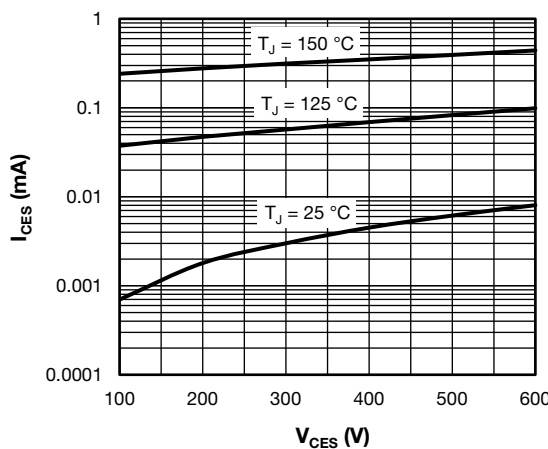

Fig. 7 - I_{CES} vs. V_{CES}
(Typical IGBT Zero Gate Voltage Collector Current)

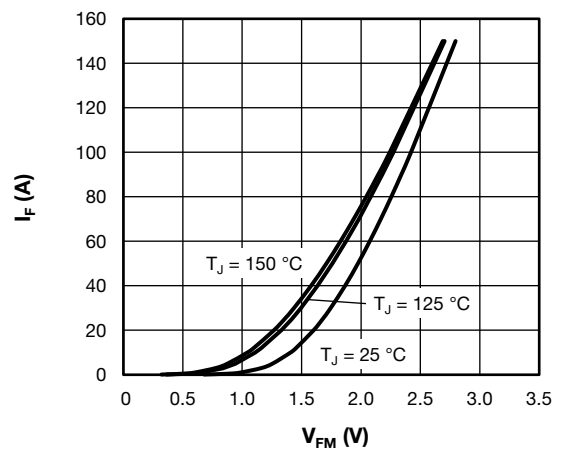

Fig. 10 - I_F vs. V_{FM}
(Typical Chopper Diode Forward Characteristics)

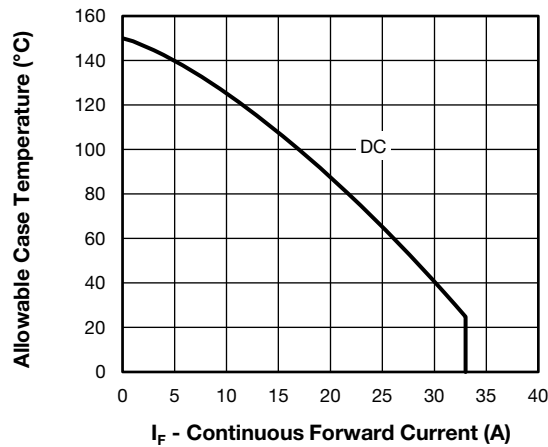

Fig. 11 - Allowable Case Temperature vs. Continuous Forward Current (Maximum Chopper Diode Continuous Forward Current vs. Case Temperature)

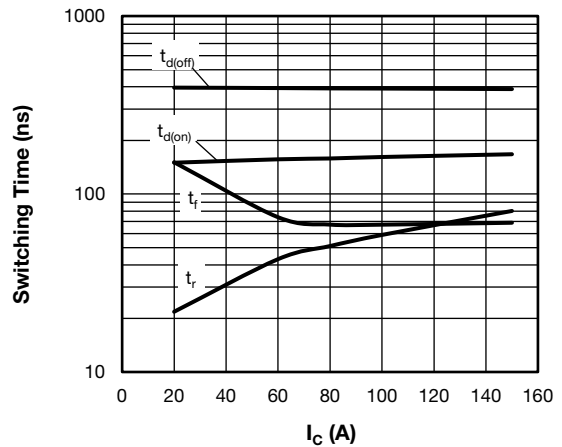

Fig. 14 - Switching Time vs. I_c
(Typical IGBT Switching Time vs. I_c)
 $T_J = 125^\circ\text{C}$, $V_{CC} = 300\text{ V}$, $R_g = 4.7\ \Omega$, $V_{GE} = 15\text{ V}$, $L = 500\ \mu\text{H}$

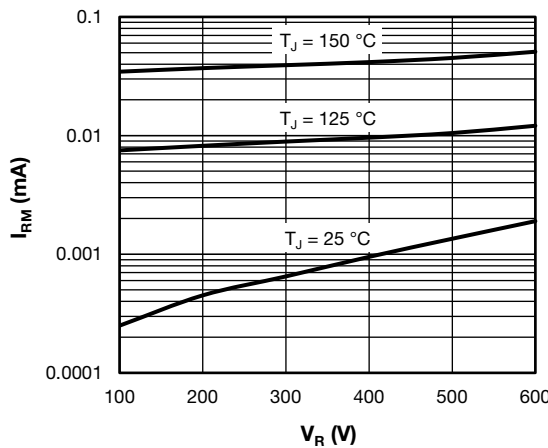

Fig. 12 - I_{RM} vs. V_R
(Typical Chopper Diode Reverse Leakage Current)

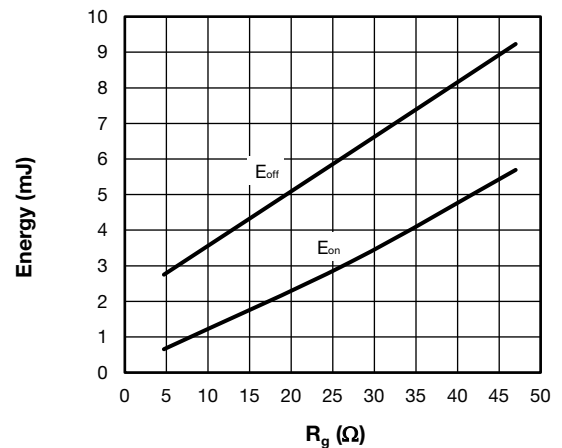

Fig. 15 - Energy Loss vs. R_g
(Typical IGBT Energy Loss vs. R_g)
 $T_J = 125^\circ\text{C}$, $V_{CC} = 300\text{ V}$, $I_c = 150\text{ A}$, $V_{GE} = 15\text{ V}$, $L = 500\ \mu\text{H}$

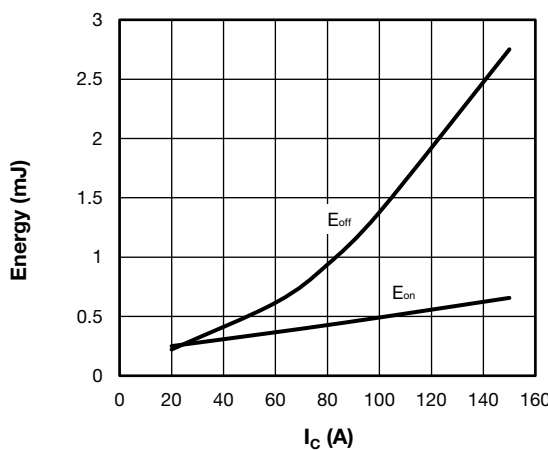

Fig. 13 - Energy Loss vs. I_c
(Typical IGBT Energy Loss vs. I_c)
 $T_J = 125^\circ\text{C}$, $V_{CC} = 300\text{ V}$, $R_g = 4.7\ \Omega$, $V_{GE} = 15\text{ V}$, $L = 500\ \mu\text{H}$

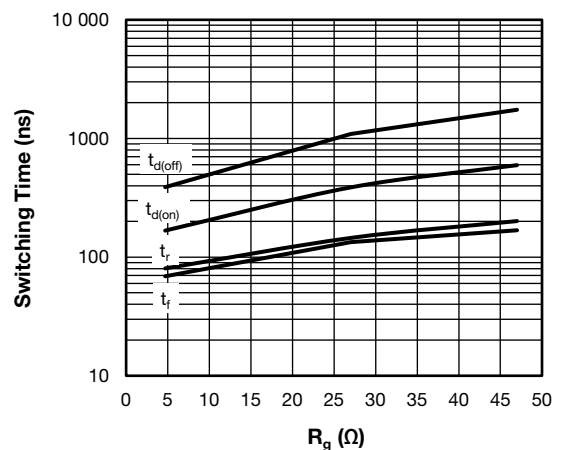

Fig. 16 - Switching Time vs. R_g
(Typical IGBT Switching Time vs. R_g)
 $T_J = 125^\circ\text{C}$, $V_{CC} = 300\text{ V}$, $I_c = 150\text{ A}$, $V_{GE} = 15\text{ V}$, $L = 500\ \mu\text{H}$

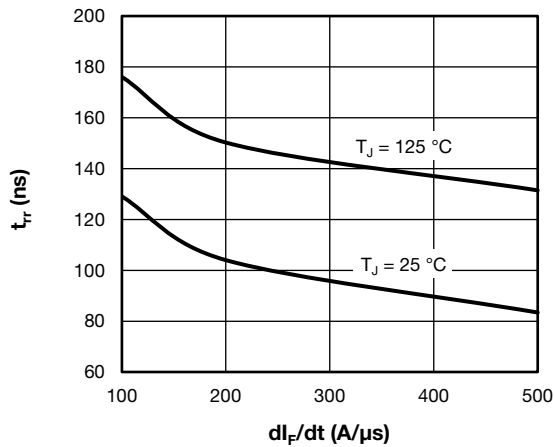

Fig. 17 - t_{rr} vs. di_F/dt
(Typical Antiparallel Diode Reverse Recovery Time vs. di_F/dt)
 $V_{rr} = 200\text{ V}$, $I_F = 10\text{ A}$

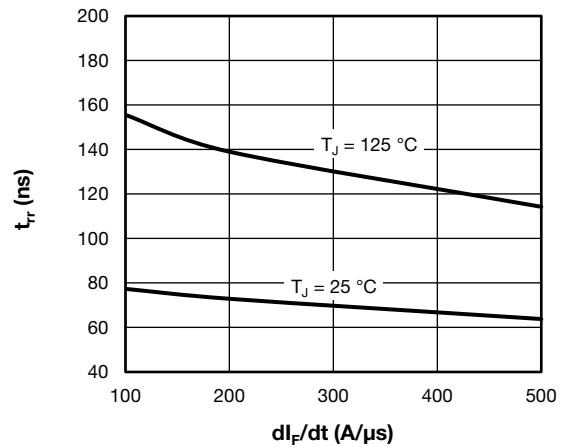

Fig. 20 - t_{rr} vs. di_F/dt
(Typical Chopper Diode Reverse Recovery Time vs. di_F/dt)
 $V_{rr} = 200\text{ V}$, $I_F = 50\text{ A}$

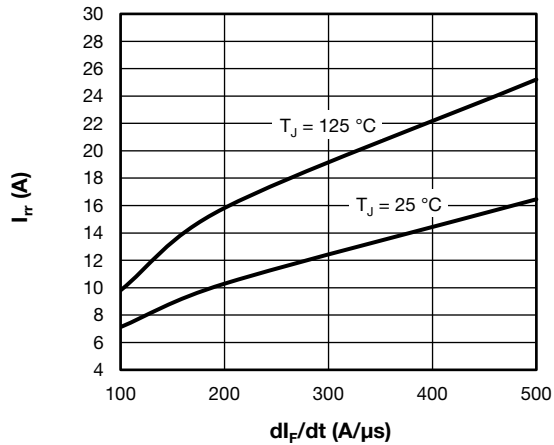

Fig. 18 - I_{rr} vs. di_F/dt
(Typical Antiparallel Diode Reverse Recovery Current vs. di_F/dt)
 $V_{rr} = 200\text{ V}$, $I_F = 10\text{ A}$

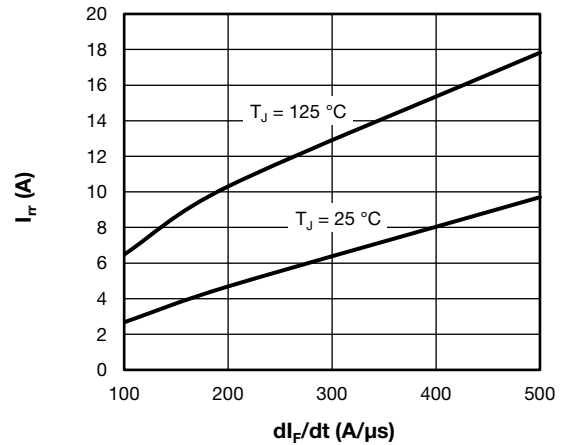

Fig. 21 - I_{rr} vs. di_F/dt
(Typical Chopper Diode Reverse Recovery Current vs. di_F/dt)
 $V_{rr} = 200\text{ V}$, $I_F = 50\text{ A}$

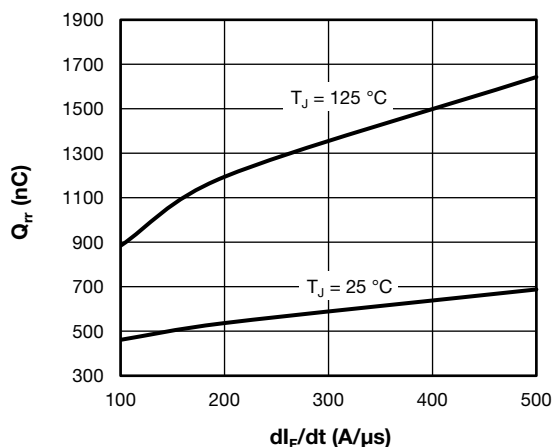

Fig. 19 - Q_{rr} vs. di_F/dt
(Typical Antiparallel Diode Reverse Recovery Charge vs. di_F/dt)
 $V_{rr} = 200\text{ V}$, $I_F = 10\text{ A}$

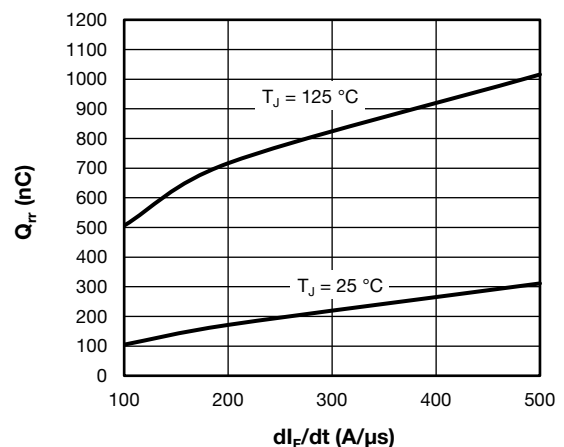

Fig. 22 - Q_{rr} vs. di_F/dt
(Typical Chopper Diode Reverse Recovery Charge vs. di_F/dt)
 $V_{rr} = 200\text{ V}$, $I_F = 50\text{ A}$

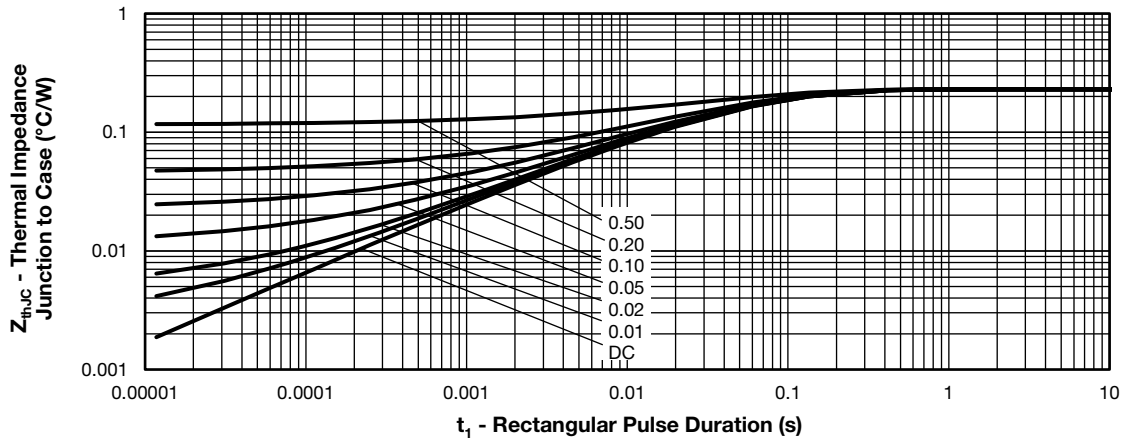

Fig. 23 - Z_{thJC} vs. t_1 Rectangular Pulse Duration
(Maximum Thermal Impedance Z_{thJC} Characteristics - (IGBT))

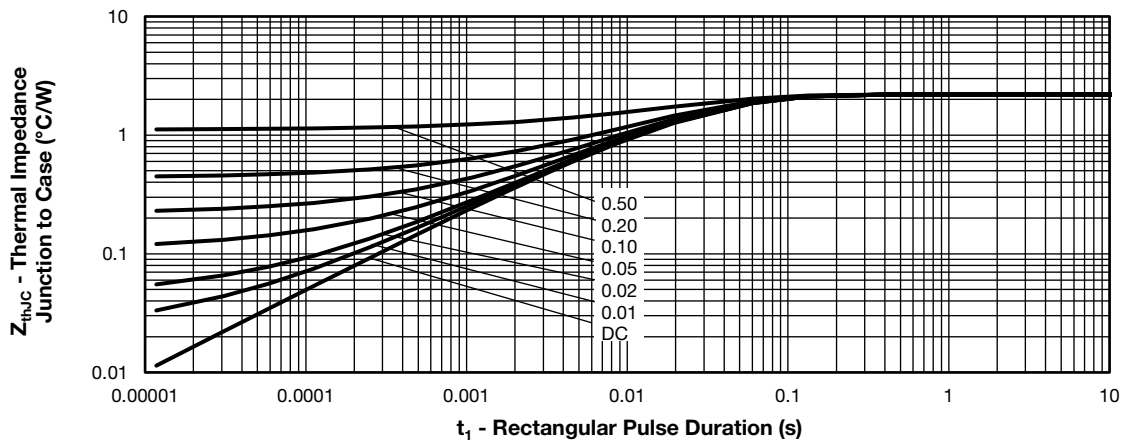
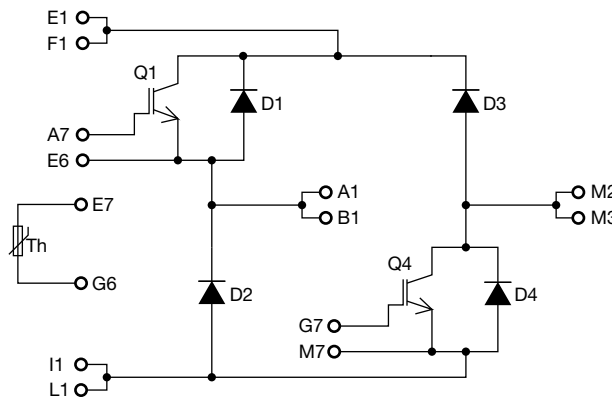

Fig. 24 - Z_{thJC} vs. t_1 Rectangular Pulse Duration
(Maximum Thermal Impedance Z_{thJC} Characteristics - (Chopper Diode))

CIRCUIT CONFIGURATION





ORDERING INFORMATION TABLE

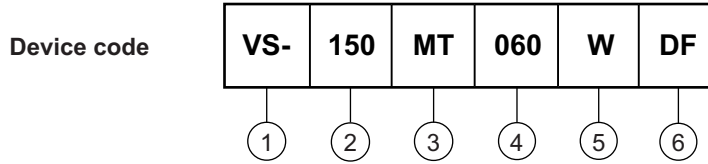

- 1** - Vishay Semiconductors product
- 2** - Current rating (150 = 150 A)
- 3** - Essential part number (MT = MTP package)
- 4** - Voltage code x 10 = Voltage rating (example: 060 = 600 V)
- 5** - Die IGBT technology (W = Warp Speed IGBT)
- 6** - Circuit configuration (DF = Dual forward)

LINKS TO RELATED DOCUMENTS	
Dimensions	www.vishay.com/doc?95383



MTP - Full Pin

DIMENSIONS in millimeters

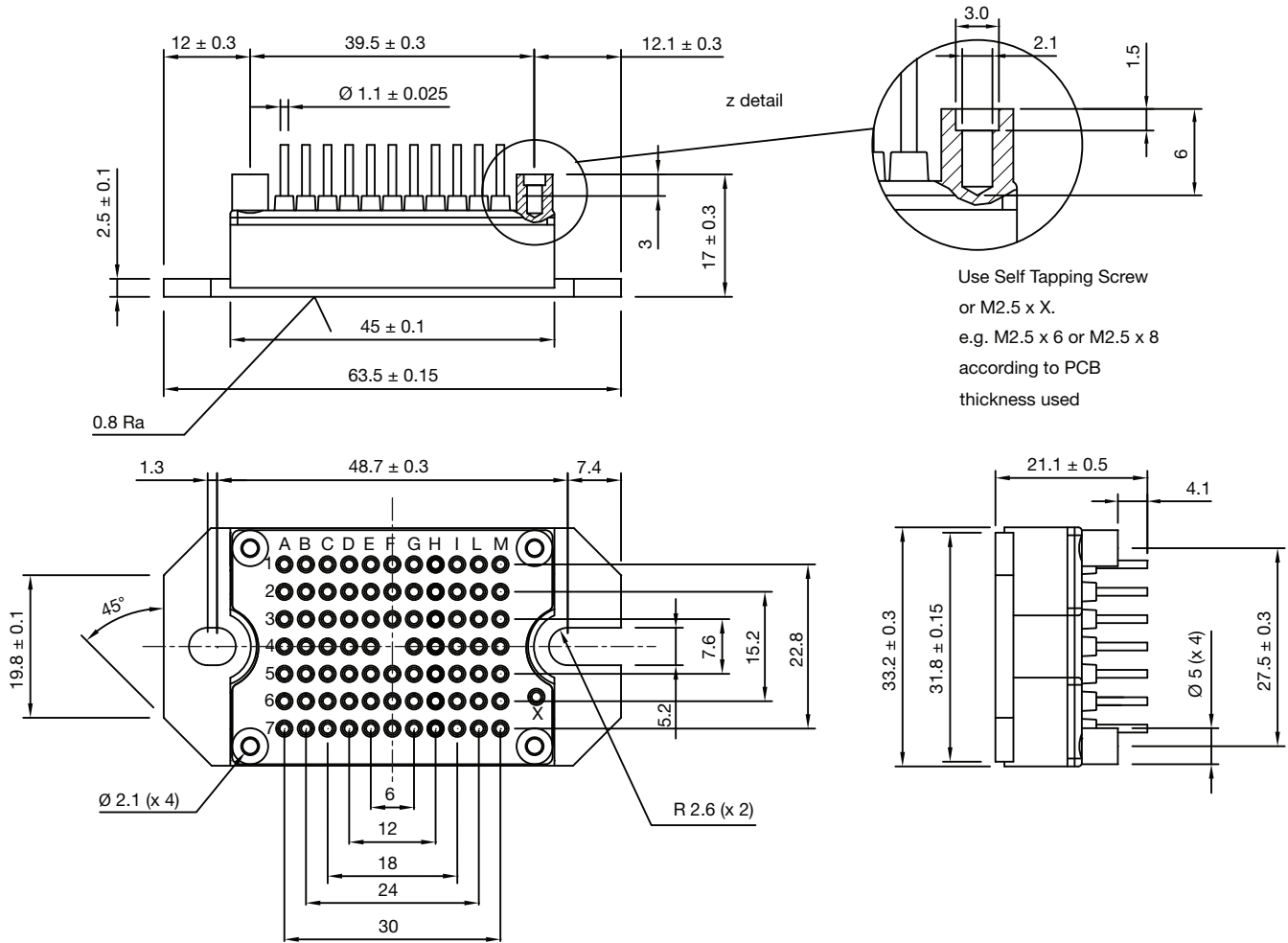

Use Self Tapping Screw
or M2.5 x X.
e.g. M2.5 x 6 or M2.5 x 8
according to PCB
thickness used

PINS POSITION
WITH TOLERANCE $\varnothing 0.6$



Disclaimer

ALL PRODUCT, PRODUCT SPECIFICATIONS AND DATA ARE SUBJECT TO CHANGE WITHOUT NOTICE TO IMPROVE RELIABILITY, FUNCTION OR DESIGN OR OTHERWISE.

Vishay Intertechnology, Inc., its affiliates, agents, and employees, and all persons acting on its or their behalf (collectively, "Vishay"), disclaim any and all liability for any errors, inaccuracies or incompleteness contained in any datasheet or in any other disclosure relating to any product.

Vishay makes no warranty, representation or guarantee regarding the suitability of the products for any particular purpose or the continuing production of any product. To the maximum extent permitted by applicable law, Vishay disclaims (i) any and all liability arising out of the application or use of any product, (ii) any and all liability, including without limitation special, consequential or incidental damages, and (iii) any and all implied warranties, including warranties of fitness for particular purpose, non-infringement and merchantability.

Statements regarding the suitability of products for certain types of applications are based on Vishay's knowledge of typical requirements that are often placed on Vishay products in generic applications. Such statements are not binding statements about the suitability of products for a particular application. It is the customer's responsibility to validate that a particular product with the properties described in the product specification is suitable for use in a particular application. Parameters provided in datasheets and / or specifications may vary in different applications and performance may vary over time. All operating parameters, including typical parameters, must be validated for each customer application by the customer's technical experts. Product specifications do not expand or otherwise modify Vishay's terms and conditions of purchase, including but not limited to the warranty expressed therein.

Except as expressly indicated in writing, Vishay products are not designed for use in medical, life-saving, or life-sustaining applications or for any other application in which the failure of the Vishay product could result in personal injury or death. Customers using or selling Vishay products not expressly indicated for use in such applications do so at their own risk. Please contact authorized Vishay personnel to obtain written terms and conditions regarding products designed for such applications.

No license, express or implied, by estoppel or otherwise, to any intellectual property rights is granted by this document or by any conduct of Vishay. Product names and markings noted herein may be trademarks of their respective owners.