

Zinc Oxide Varistors



VE/VF Types for Heavy Duty Applications (“P Series”)

FEATURES

- “P Series” are especially dedicated to heavy duty applications encountered in the AC power network. Higher surge current and energy ratings provide an improved protection and a better reliability
- Radial lead varistors
- Operating voltage range from 130 V to 625 V (V_{rms} for VE types) or 205 V to 1000 V (V_{1mA} for VF types)
- Available in tape and reel for use with automatic insertion equipment (see pages 31 to 33 for details).

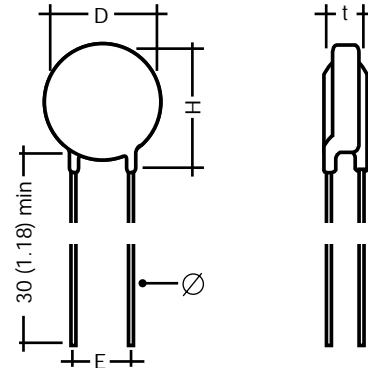

PARTICULAR CHARACTERISTICS

UL (USA and Canadian Standards)	VE Series P/N codification using (D_{max} , V_{rms})	VF Series P/N codification using ($d_{ceramic}$, V_{1mA})	Maximum operating voltage		Nominal voltage at 1 mA dc		
			V_{rms}	V_{DC}	$V_{1mA\ mini}$	$V_{1mA\ nominal}$	$V_{1mA\ maxi}$
★ ★ ★ ★ ★	VE07P00131K __ VE09P00131K __ VE13P00131K __ VE17P00131K __ VE24P00131K __	VF05P12050K __ VF07P12050K __ VF10P12050K __ VF14P12050K __ VF20P12050K __	130	170	184	205	226
★ ★ ★ ★ ★	VE07P00141K __ VE09P00141K __ VE13P00141K __ VE17P00141K __ VE24P00141K __	VF05P10221K __ VF07P10221K __ VF10P10221K __ VF14P10221K __ VF20P10221K __	140	180	198	220	242
★ ★ ★ ★ ★	VE07P00151K __ VE09P00151K __ VE13P00151K __ VE17P00151K __ VE24P00151K __	VF05P10241K __ VF07P10241K __ VF10P10241K __ VF14P10241K __ VF20P10241K __	150	200	216	240	264
★ ★ ★ ★ ★	VE07P01750K __ VE09P01750K __ VE13P01750K __ VE17P01750K __ VE24P01750K __	VF05P10271K __ VF07P10271K __ VF10P10271K __ VF14P10271K __ VF20P10271K __	175	225	243	270	297
★ ★ ★ ★ ★	VE07P00211K __ VE09P00211K __ VE13P00211K __ VE17P00211K __ VE24P00211K __	VF05P10331K __ VF07P10331K __ VF10P10331K __ VF14P10331K __ VF20P10331K __	210	275	297	330	363
★ ★ ★ ★ ★	VE07P00231K __ VE09P00231K __ VE13P00231K __ VE17P00231K __ VE24P00231K __	VF05P10361K __ VF07P10361K __ VF10P10361K __ VF14P10361K __ VF20P10361K __	230	300	324	360	396

Zinc Oxide Varistors



VE/VF Types for Heavy Duty Applications ("P Series")

DIMENSIONS millimeters (inches)

Type	Type	D		H max.	t max.	ϕ +10% -0.05 (.002)	E ± 0.8
		Ceramic diameter	Maximum coated diameter				
VE07	VF05	5 (.196)	7 (.275)	10 (.394)		0.6 (.024)	5.08 (0.20)
VE09	VF07	7 (.275)	9 (.354)	12 (.472)		0.6 (.024)	5.08 (0.20)
VE13*	VF10*	10 (.393)	13* (.512)	16 (.630)	see table	0.8* (.031)	7.62* (0.30)
VE17	VF14	14 (.551)	17 (.669)	20 (.787)		0.8 (.031)	7.62 (0.30)
VE24**	VF20**	20 (.787)	24 (.945)	27 (1.06)		0.8** (.031)	7.62 (0.30)

* VE13 / VF10: For models with $V_{RMS} \leq 320$ V
 other version/suffixes available with:
 E = 5.08 (0.20) Suffix:
 $\phi = 0.6 (.024)$ Bulk: HB
 D = 12.5 (.492) max Tape: DA, DB, DC,
 DD, DQ, ...

**VE24 / VF20: For lead diameter = 1.0 (.039),
 please consult us.

GENERAL CHARACTERISTICS

Storage temperature: -40°C to +125°C
 Max. operating temperature: +85°C
 Response time: < 25 ns
 Voltage coefficient temp.: $|K| < 0.09\%/^{\circ}\text{C}$
 Voltage proof: 2500 V
 Epoxy coating: Flame retardant
 UL94-VO

MARKING

Type
 AC nominal voltage (EIA coding) for VE types
 V_{1mA} varistor voltage (EIA coding) for VF types
 Logo
 UL logo (when approved)
 Lot number (VE13/17/24 and VF10/14/20 only)

Max. clamping voltage (8 x 20 μs)		Max. energy absorption (10 x 1000 μs) W (J) Number of surges 1 surge	Max. permissible peak current (8 x 20 μs) Ip (A)		Typical capacitance f = 1kHz pF	Mean power dissipation W	Maximum thickness t mm (inches)	V/I characteristic Page	Derating curves Page
Vp (V)	Ip (A)		1 surge	2 surges					
340	5	8.5	800	600	90	0.1	4.1 (.161)	34	24
340	10	17.5	1750	1250	250	0.2	4.1 (.161)	34	25
340	25	35	3500	2500	450	0.4	4.7 (.185)	34	26
340	50	70	6000	4500	1000	0.6	4.7 (.185)	35	27
340	100	140	10000	7000	2500	0.8	5.1 (.201)	35	28
360	5	9	800	600	85	0.1	4.2 (.165)	34	24
360	10	19	1750	1250	235	0.2	4.2 (.165)	34	25
360	25	39	3500	2500	425	0.4	4.8 (.189)	34	26
360	50	78	6000	4500	930	0.6	4.8 (.189)	35	27
360	100	155	10000	7000	2250	0.8	5.2 (.205)	35	28
400	5	10.5	800	600	80	0.1	4.3 (.169)	34	24
400	10	21	1750	1250	220	0.2	4.3 (.169)	34	25
400	25	42	3500	2500	400	0.4	4.9 (.193)	34	26
400	50	85	6000	4500	850	0.6	4.9 (.193)	35	27
400	100	170	10000	7000	2000	0.8	5.3 (.209)	35	28
445	5	11	800	600	70	0.1	4.5 (.177)	34	24
445	10	24	1750	1250	190	0.2	4.5 (.177)	34	25
445	25	50	3500	2500	340	0.4	5.1 (.201)	34	26
445	50	100	6000	4500	750	0.6	5.1 (.201)	35	27
445	100	190	10000	7000	2000	0.8	5.5 (.217)	35	28
545	5	13	800	600	60	0.1	4.9 (.193)	34	24
545	10	28	1750	1250	155	0.2	4.9 (.193)	34	25
545	25	60	3500	2500	275	0.4	5.5 (.217)	34	26
545	50	115	6000	4500	600	0.6	5.5 (.217)	35	27
545	100	230	10000	7000	1650	0.8	5.9 (.232)	35	28
595	5	16	800	600	55	0.1	5.1 (.201)	34	24
595	10	32	1750	1250	140	0.2	5.1 (.201)	34	25
595	25	65	3500	2500	250	0.4	5.7 (.224)	34	26
595	50	130	6000	4500	550	0.6	5.7 (.224)	35	27
595	100	250	10000	7000	1500	0.8	6.1 (.240)	35	28

Zinc Oxide Varistors



VE/VF Types for Heavy Duty Applications ("P Series")

UL (USA and Canadian Standards)	VE Series P/N codification using (D_{max} / V_{rms})	VF Series P/N codification using ($d_{ceramic}$ / V_{1mA})	Maximum operating voltage		Nominal voltage at 1 mA dc		
			V_{rms}	V_{DC}	$V_{1mA\ mini}$	$V_{1mA\ nominal}$	$V_{1mA\ maxi}$
★ ★ ★ ★ ★	VE07P00251K __ VE09P00251K __ VE13P00251K __ VE17P00251K __ VE24P00251K __	VF05P10391K __ VF07P10391K __ VF10P10391K __ VF14P10391K __ VF20P10391K __	250	320	351	390	429
★ ★ ★ ★ ★	VE07P02750K __ VE09P02750K __ VE13P02750K __ VE17P02750K __ VE24P02750K __	VF05P10431K __ VF07P10431K __ VF10P10431K __ VF14P10431K __ VF20P10431K __	275	350	387	430	473
★ ★ ★ ★ ★	VE07P00301K __ VE09P00301K __ VE13P00301K __ VE17P00301K __ VE24P00301K __	VF05P10471K __ VF07P10471K __ VF10P10471K __ VF14P10471K __ VF20P10471K __	300	385	423	470	517
★ ★ ★ ★	VE09P00321K __ VE13P00321K __ VE17P00321K __ VE24P00321K __	VF07P10511K __ VF10P10511K __ VF14P10511K __ VF20P10511K __	320	420	459	510	561
★ ★ ★ ★	VE09P00351K __ VE13P00351K __ VE17P00351K __ VE24P00351K __	VF07P10561K __ VF10P10561K __ VF14P10561K __ VF20P10561K __	350	460	504	560	616
★ ★ ★ ★	VE09P03850K __ VE13P03850K __ VE17P03850K __ VE24P03850K __	VF07P10621K __ VF10P10621K __ VF14P10621K __ VF20P10621K __	385	505	558	620	682
★ ★ ★ ★	VE09P00421K __ VE13P00421K __ VE17P00421K __ VE24P00421K __	VF07P10681K __ VF10P10681K __ VF14P10681K __ VF20P10681K __	420	560	612	680	748
★ ★ ★	VE13P00441K __ VE17P00441K __ VE24P00441K __	VF10P17150K __ VF14P17150K __ VF20P17150K __	440	585	643	715	787
★ ★ ★	VE13P00461K __ VE17P00461K __ VE24P00461K __	VF10P10751K __ VF14P10751K __ VF20P10751K __	460	615	675	750	825
★ ★ ★	VE13P00511K __ VE17P00511K __ VE24P00511K __	VF10P10821K __ VF14P10821K __ VF20P10821K __	510	670	738	820	902
★ ★ ★	VE13P00551K __ VE17P00551K __ VE24P00551K __	VF10P10861K __ VF14P10861K __ VF20P10861K __	550	715	774	860	946
★ ★ ★	VE13P05750K __ VE17P05750K __ VE24P05750K __	VF10P10911K __ VF14P10911K __ VF20P10911K __	575	730	819	910	1001
★ ★ ★	VE13P06250K __ VE17P06250K __ VE24P06250K __	VF10P10102K __ VF14P10102K __ VF20P10102K __	625	825	900	1000	1100

Zinc Oxide Varistors



VE/VF Types for Heavy Duty Applications ("P Series")

Max. clamping voltage (8 x 20 μ s)		Max. energy absorption (10 x 1000 μ s) W (J) Number of surges 1 surge	Max. permissible peak current (8 x 20 μ s) Ip (A)		Typical capacitance f = 1kHz pF	Mean power dissipation W	Maximum thickness t mm (inches)	V/I characteristic	Derating curves
Vp (V)	Ip (A)		1 surge	2 surges				Page	Page
645	5	17	800	600	50	0.1	5.4 (.213)	34	24
645	10	35	1750	1250	130	0.2	5.4 (.213)	34	25
645	25	70	3500	2500	230	0.4	5.9 (.232)	34	26
645	50	140	6000	4500	500	0.6	5.9 (.232)	35	27
645	100	280	10000	7000	1300	0.8	6.3 (.248)	35	28
710	5	20	800	600	45	0.1	5.7 (.224)	34	24
710	10	40	1750	1250	120	0.2	5.7 (.224)	34	25
710	25	80	3500	2500	210	0.4	6.3 (.248)	34	26
710	50	160	6000	4500	450	0.6	6.3 (.248)	35	27
710	100	310	10000	7000	1200	0.8	6.7 (.264)	35	28
775	5	21	800	600	40	0.1	6.0 (.236)	34	24
775	10	42	1750	1250	100	0.2	6.0 (.236)	34	25
775	25	85	3500	2500	180	0.4	6.6 (.260)	34	26
775	50	170	6000	4500	400	0.6	6.6 (.260)	35	27
775	100	340	10000	7000	1000	0.8	7.0 (.276)	35	28
840	10	45	1750	1250	100	0.2	6.4 (.252)	34	25
840	25	90	3500	2500	170	0.4	7.0 (.276)	34	26
840	50	180	5000	4000	380	0.6	7.0 (.276)	35	27
840	100	360	8000	6000	950	0.8	7.5 (.295)	35	28
910	10	47	1750	1250	95	0.2	6.6 (.260)	34	25
910	25	95	3500	2500	160	0.4	7.3 (.287)	34	26
910	50	190	5000	4000	365	0.6	7.3 (.287)	35	27
910	100	380	8000	6000	900	0.8	7.8 (.307)	35	28
1025	10	50	1750	1250	95	0.2	7.0 (.276)	34	25
1025	25	100	3500	2500	150	0.4	7.7 (.303)	34	26
1025	50	200	5000	4000	350	0.6	7.7 (.303)	35	27
1025	100	400	8000	6000	850	0.8	8.1 (.319)	35	28
1120	10	52	1750	1250	80	0.2	7.4 (.291)	34	25
1120	25	105	3500	2500	120	0.4	8.2 (.323)	34	26
1120	50	210	5000	4000	300	0.6	8.2 (.323)	35	27
1120	100	420	8000	6000	700	0.8	8.6 (.339)	35	28
1180	25	105	3500	2500	115	0.4	8.4 (.331)	34	26
1180	50	210	5000	4000	275	0.6	8.4 (.331)	35	27
1180	100	420	8000	6000	650	0.8	8.8 (.346)	35	28
1240	25	105	3500	2500	110	0.4	8.5 (.335)	34	26
1240	50	210	5000	4000	250	0.6	8.5 (.335)	35	27
1240	100	420	8000	6000	600	0.8	9.0 (.354)	35	28
1350	25	110	3500	2500	100	0.4	9.0 (.354)	34	26
1350	50	225	5000	4000	220	0.6	9.0 (.354)	35	27
1350	100	450	7500	6000	550	0.8	9.4 (.370)	35	28
1420	25	120	3500	2500	90	0.4	9.3 (.366)	34	26
1420	50	240	5000	4000	200	0.6	9.3 (.366)	35	27
1420	100	480	7500	6000	500	0.8	9.7 (.382)	35	28
1500	25	125	3500	2500	80	0.4	9.7 (.382)	34	26
1500	50	250	5000	4000	180	0.6	9.7 (.382)	35	27
1500	100	500	7500	6000	450	0.8	10.1 (.398)	35	28
1650	25	140	3500	2500	74	0.4	10.5 (.413)	34	26
1650	50	230	5000	4000	165	0.6	10.5 (.413)	35	27
1650	100	560	7500	6000	410	0.8	11.0 (.433)	35	28

Zinc Oxide Varistors



Electrical Characteristics VE / VF Types

VOLTAGE-CURRENT CHARACTERISTICS

V/I characteristics give:

- for I below 1 mA the maximum leakage current under V_{dc}
- for I above 1 mA the maximum clamping voltage

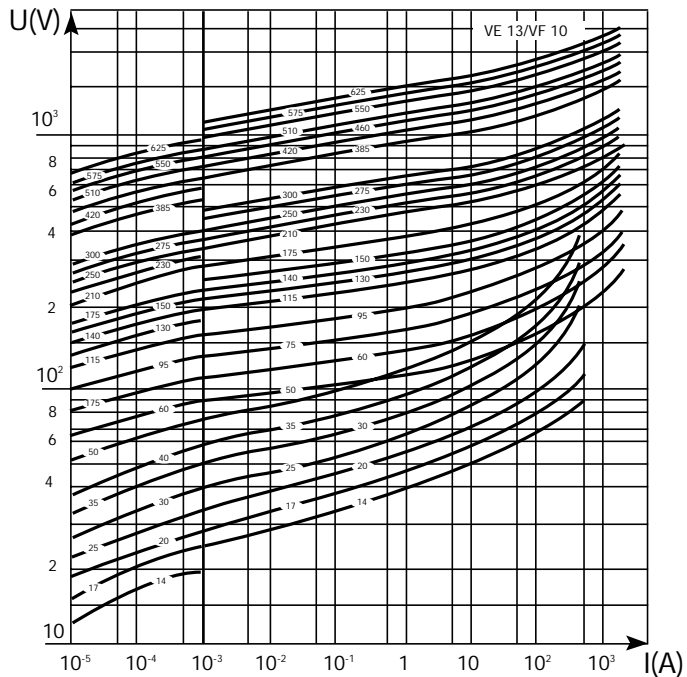
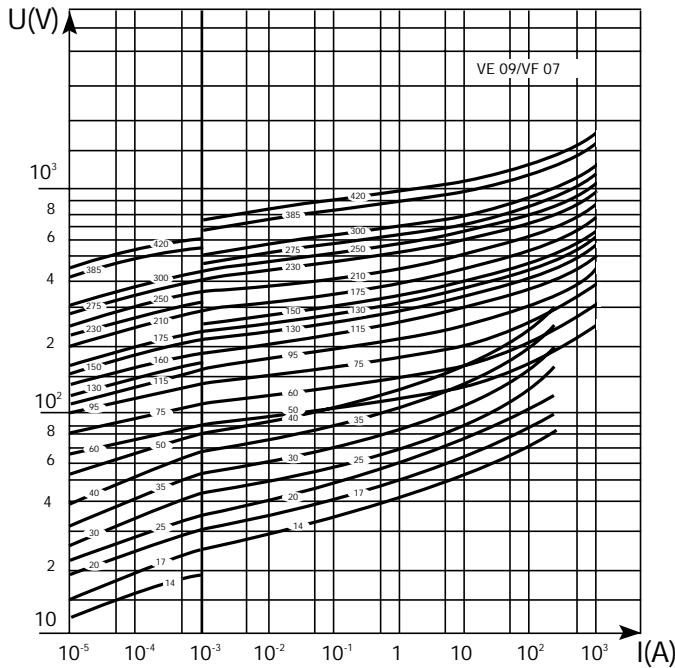
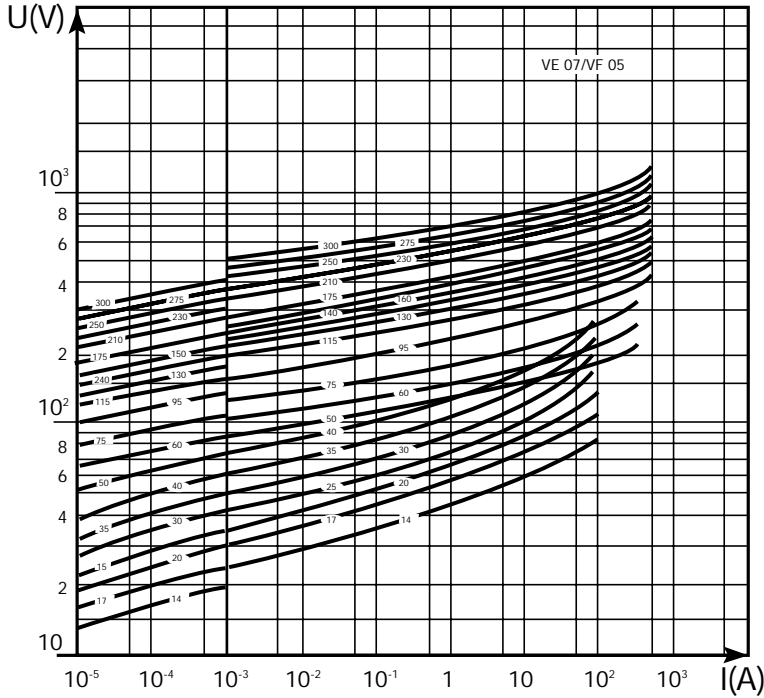

Zinc Oxide Varistors



Electrical Characteristics VE / VF Types

VOLTAGE-CURRENT CHARACTERISTICS

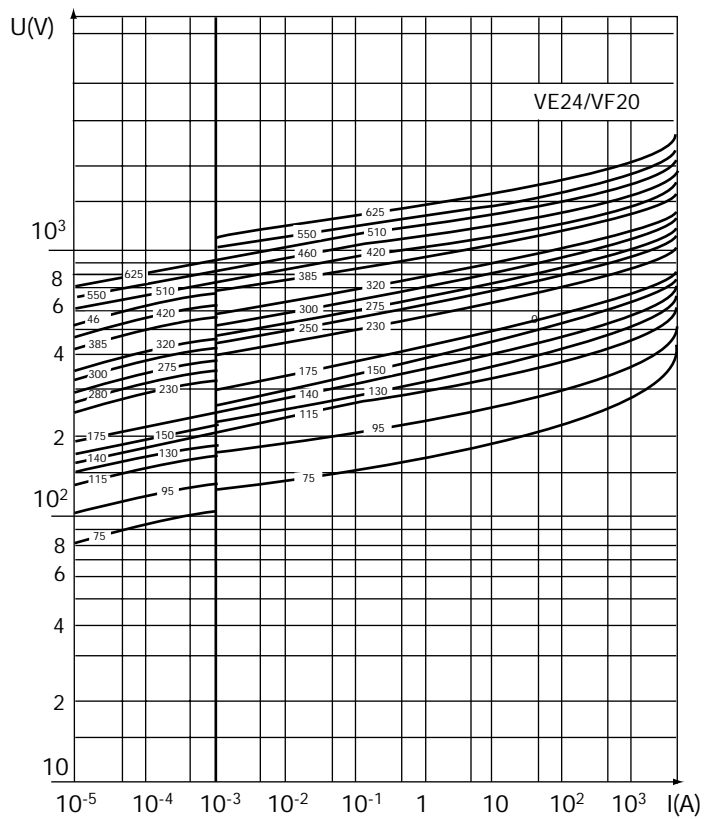
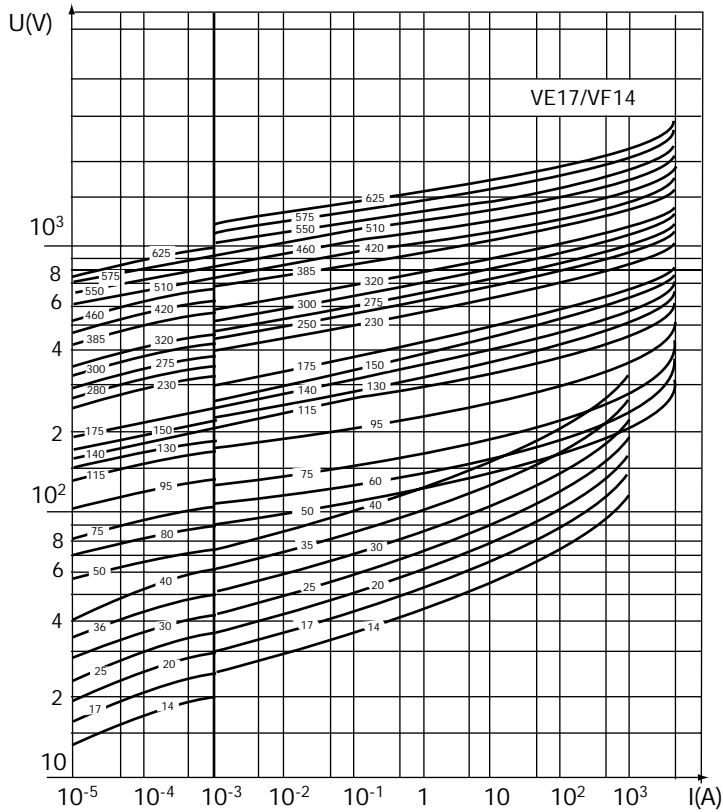

TPC

Zinc Oxide Varistors



Electrical Characteristics VE / VF Types

MAXIMUM SURGE CURRENT (I_p) DERATING CURVES WITH PULSE WIDTH (τ) AND FREQUENCY

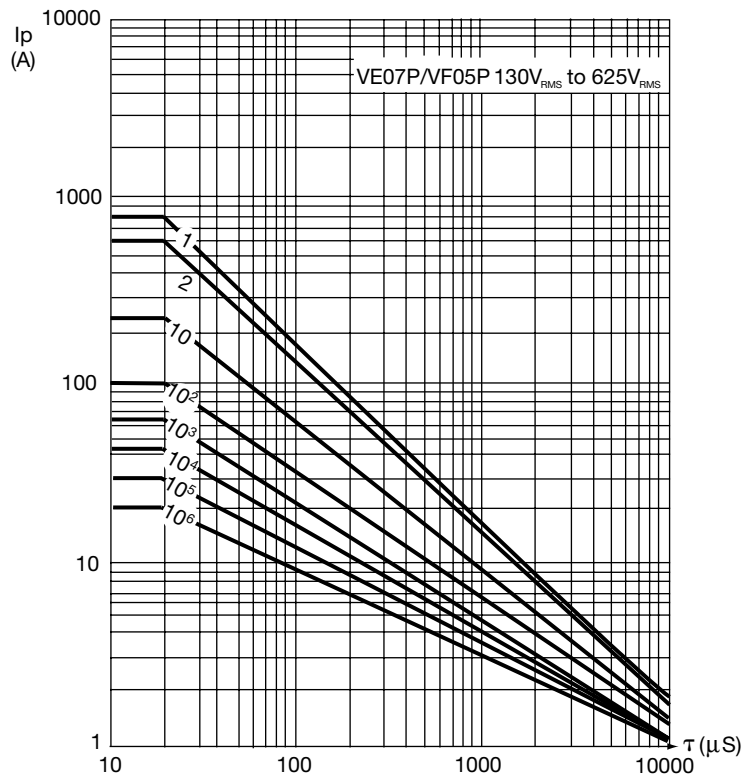
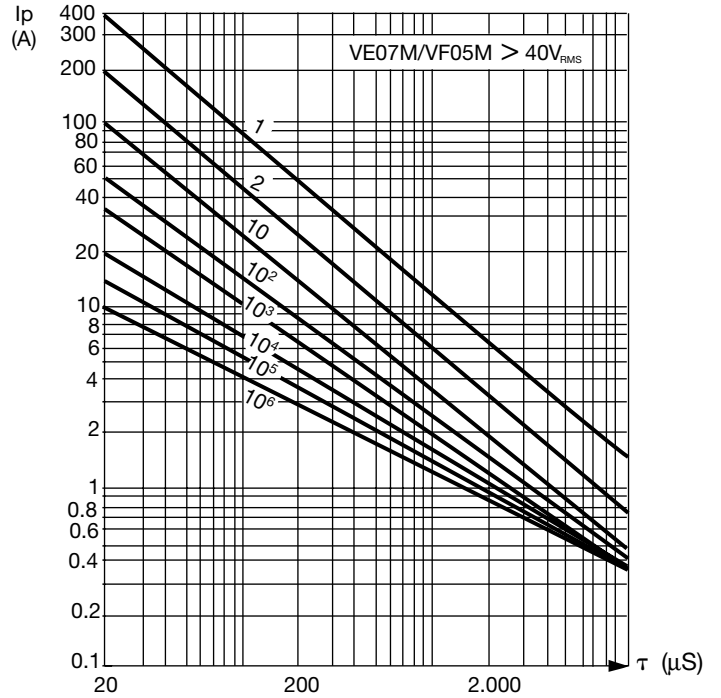
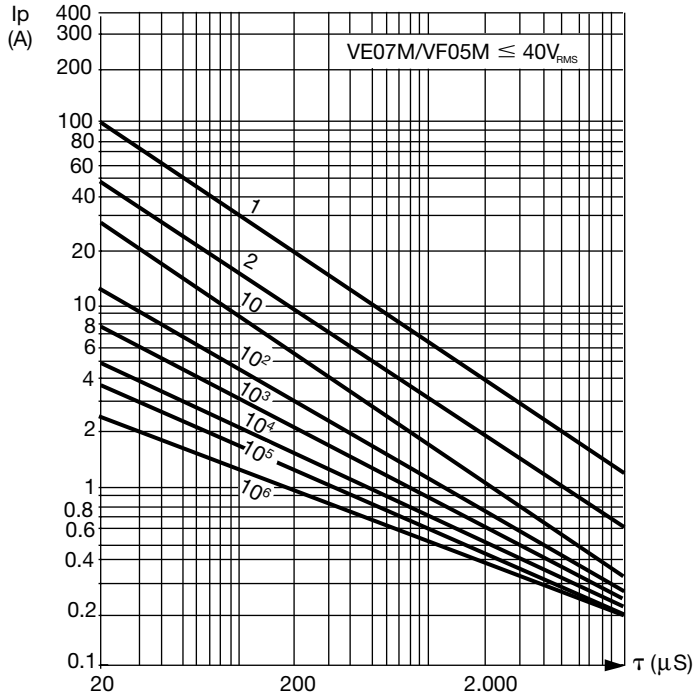

Zinc Oxide Varistors



Electrical Characteristics VE / VF Types

MAXIMUM SURGE CURRENT (I_p) DERATING CURVES WITH PULSE WIDTH (τ) AND FREQUENCY

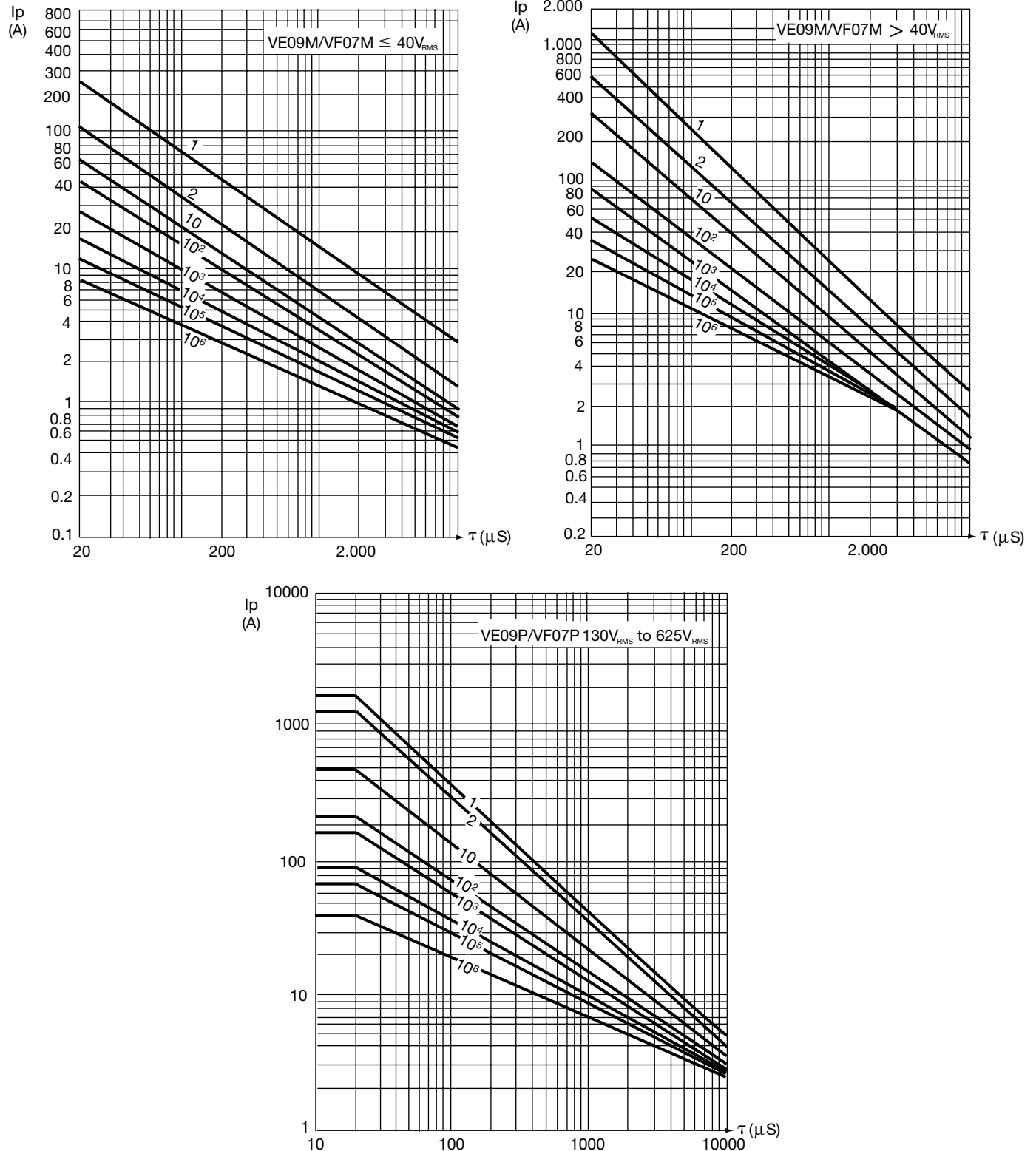

Zinc Oxide Varistors



Electrical Characteristics VE / VF Types

MAXIMUM SURGE CURRENT (I_p) DERATING CURVES WITH PULSE WIDTH (τ) AND FREQUENCY

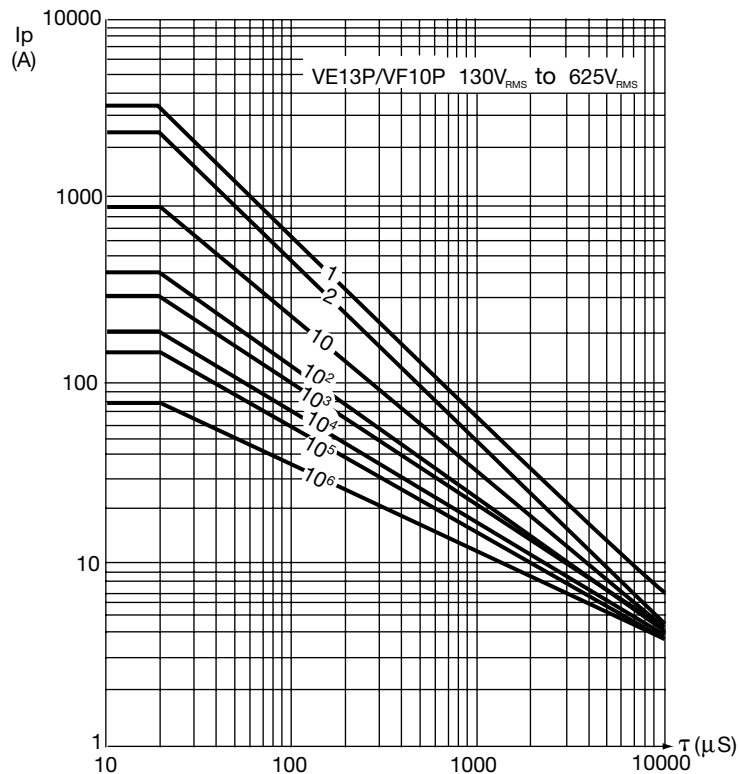
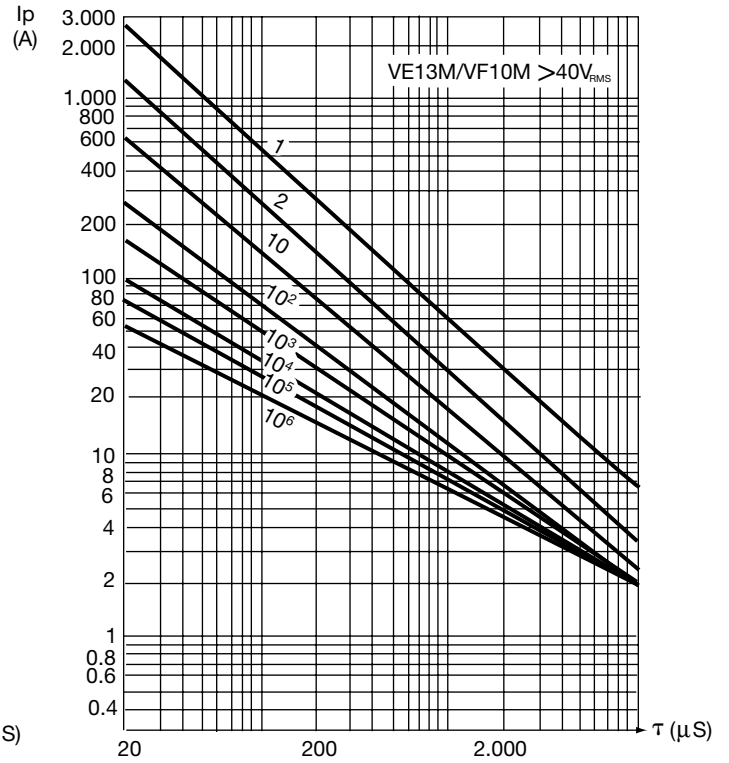
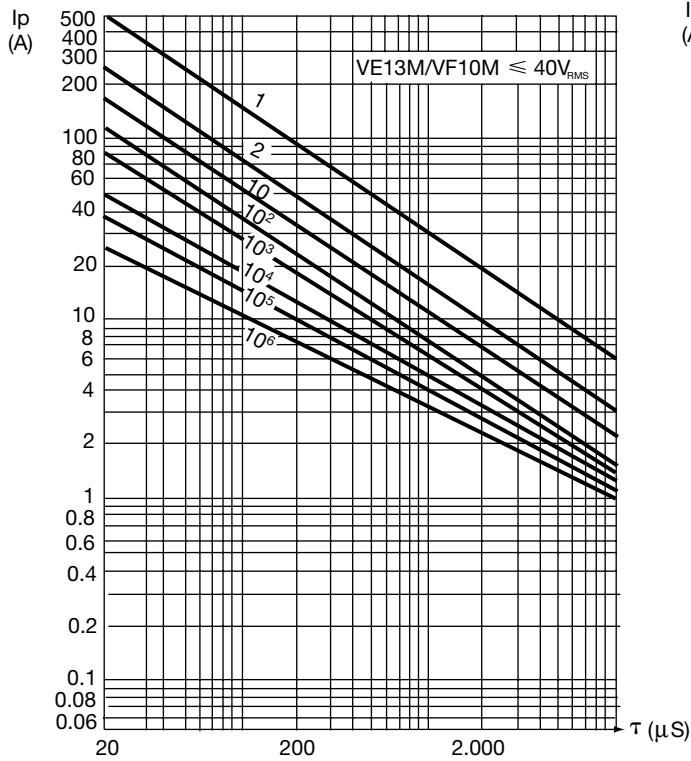

Zinc Oxide Varistors



Electrical Characteristics VE / VF Types

MAXIMUM SURGE CURRENT (I_p) DERATING CURVES WITH PULSE WIDTH (τ) AND FREQUENCY

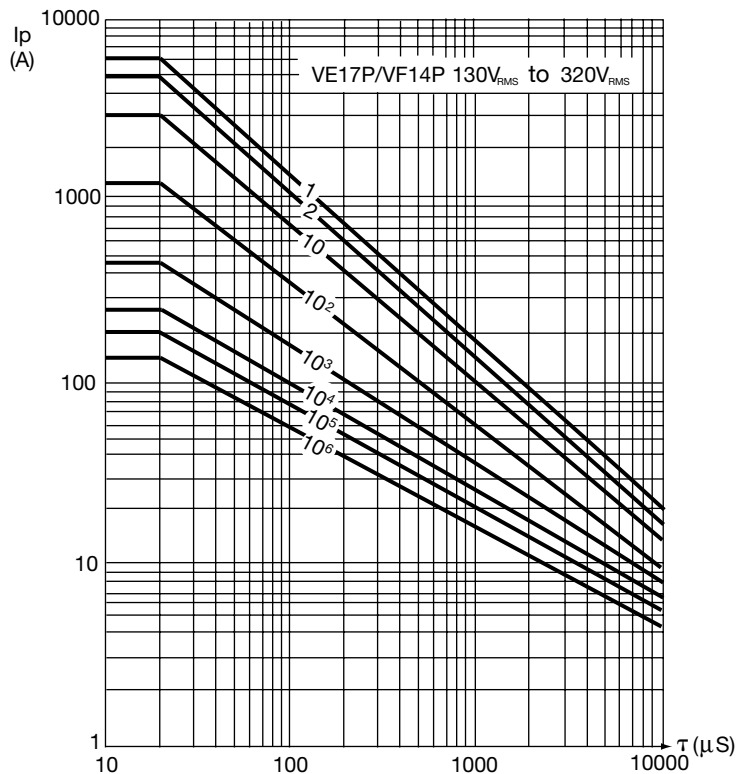
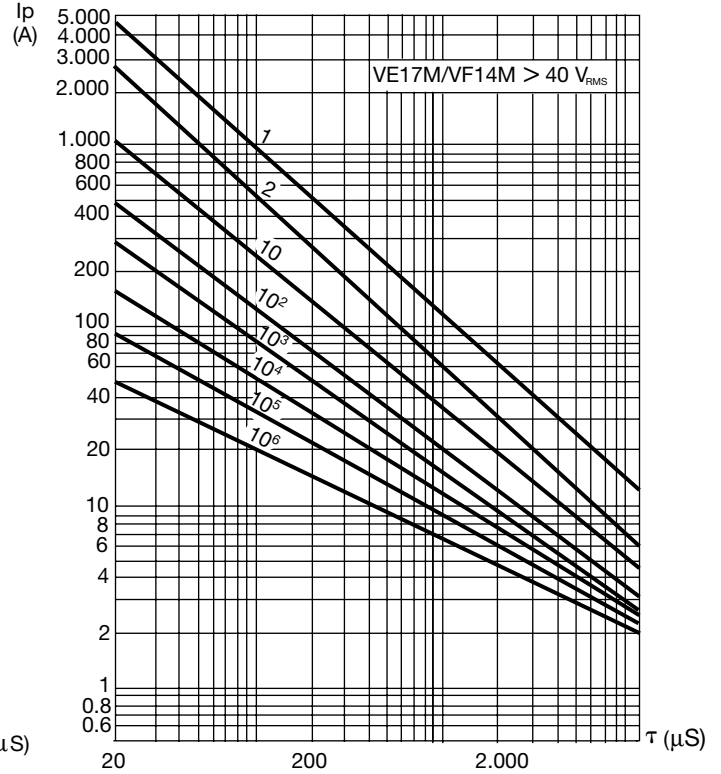
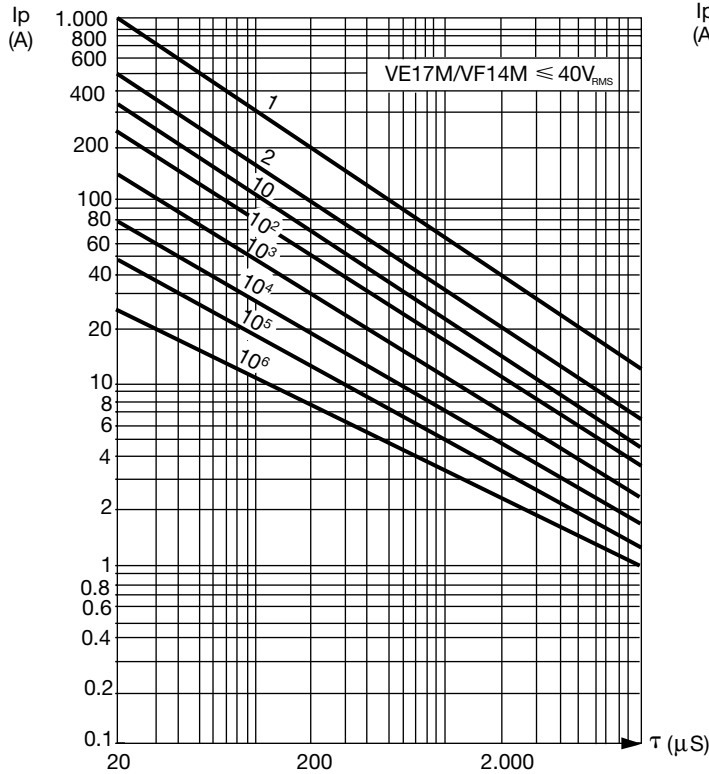

Zinc Oxide Varistors



Electrical Characteristics VE / VF Types

MAXIMUM SURGE CURRENT (I_p) DERATING CURVES WITH PULSE WIDTH (τ) AND FREQUENCY

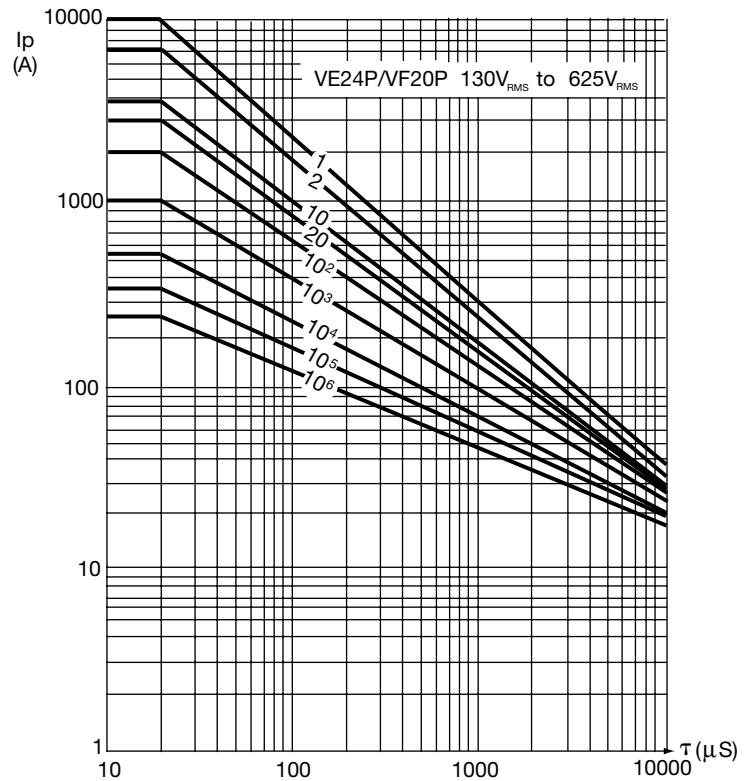
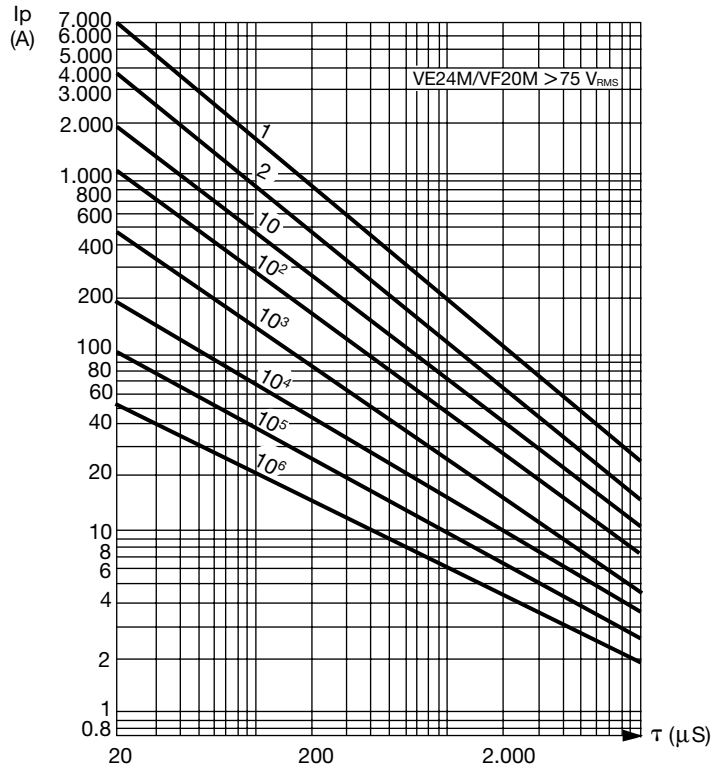

Zinc Oxide Varistors



Ordering Code

HOW TO ORDER

VE09

Type

VE 07
VE 09
VE 13
VE 17
VE 24
VF 05
VF 07
VF 10
VF 14
VF 20
VN 32
VB 32

M

Series

M: Varistors for general applications
P: Varistors for heavy duty applications

0

Marking

AC nominal voltage
VE:0

Nominal voltage at 1 mA dc
VF:1

0251

AC Operating Voltage
(EIA coding)
VE

Nominal Voltage
at 1 mA dc
(EIA coding)
VF

K

Tolerance
at 1 mA
K: ±10%
(J: ±5% upon request)

--

Suffixes
See on page 32

-
1. Operating voltage expressed by 2 significant figures:
1st digit: 0 (zero).
2nd and 3rd digit: the two significant figures of the operating voltage.
4th digit: the number of ZEROS to be added to the operating voltage value.
Examples: 75 V: 0750
250 V: 0251
300 V: 0301
2. Operating voltage expressed by 3 significant figures:
1st, 2nd and 3rd digit: the 3 significant figures of the operating voltage.
4th digit: the number of ZEROS to be added to the operating voltage value.
Examples: 205 V: 2050
275 V: 2750

Zinc Oxide Varistors



Taping Characteristics

TAPING OF OUR VARISTORS IS MADE ACCORDING TO IEC 286-2

Types: VE07/09 - VF05/07

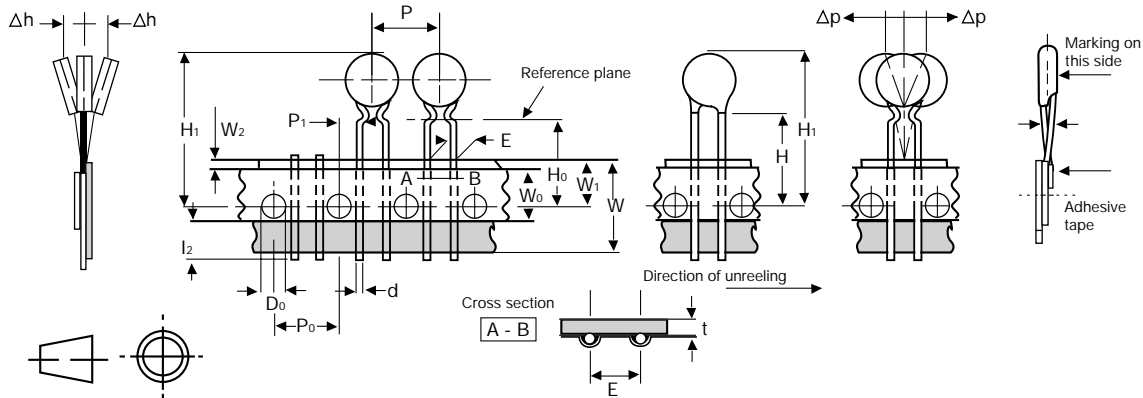

Types: VE13/17 - VF10/14

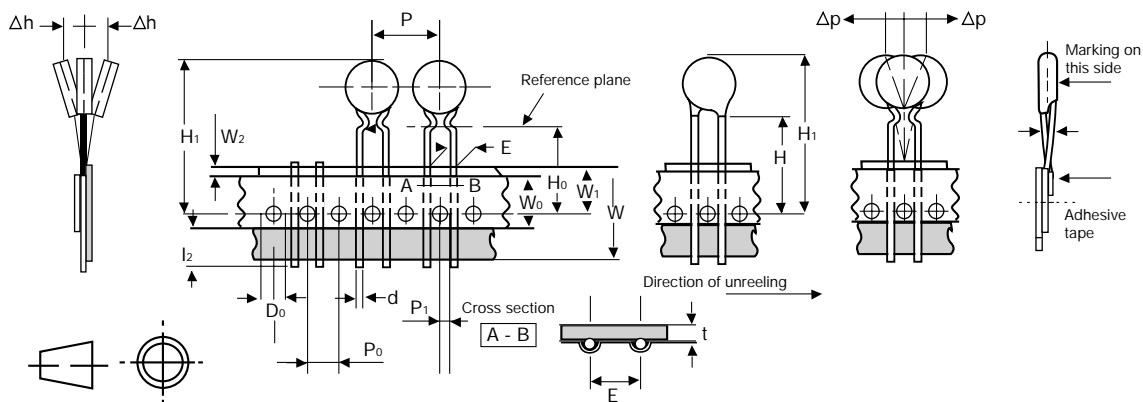

DIMENSIONS: millimeters (inches)

Dimension Characteristics	Value	Tolerance	
Leading tape width	18 (.709)	+1/-0.5	W
Adhesive tape width	The hold down tape shall not protrude beyond the carrier tape		W ₀
Sprocket hole position	9 (.354)	+0.75/-0.5	W ₁
Distance between the tops of the tape and the adhesive	3 (.118) max		W ₂
Diameter of sprocket hole	4 (.157)	±0.2	D ₀
Distance between the tape axis and the bottom plane of component body	16/ (.630)/ or 18 (.709)	±0.5/ -0/+2	H
Distance between the tape axis and the kink	16/ (.630)/ or 18 (.709)	±0.5/ -0/+2	H ₀
Distance between the tape axis and the top of component body VE 07/09 - VF 05/07 VE 13/17 - VF 10/14	33.0 (1.30) max 45.0 (1.77) max		H ₁
Lead diameter	0.6 (.024) 0.8 (.031)	+10% -0.05	d
Protrusions beyond the lower side of the hold down tape	5 (.197) max		l ₂
Lead spacing	5.08 (0.20) 7.62 (0.30)	±0.8	E
Components pitch	12.7 (0.50) 25.4 (0.10)	±0.3	p

DIMENSIONS: millimeters (inches)

Dimension Characteristics	Value	Tolerance	
Sprocket holes pitch	12.7 (0.50)	±0.3	P ₀
Distance between the sprocket hole axis and the lead axis	3.8 (.150)	±0.7	P ₁
Total thickness of tape	0.9 (.035) max		t
Verticality of components	0	±2	Δρ
Alignment of components	0	±2	Δh

Zinc Oxide Varistors



Taping Characteristics

PACKAGING

For automatic insertion, the following types can be ordered on tape either in AMMOPACK (fan folder) or on REEL in accordance to IEC 286-2.

AMMOPACK

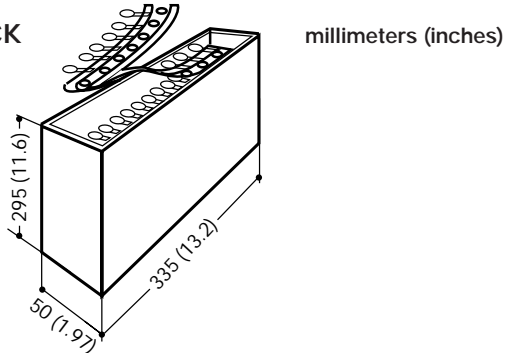

MISSING COMPONENTS

A maximum of 3 consecutive components may be missing from the bandolier, surrounded by at least 6 filled positions. The number of missing components may not exceed 0.5% of the total per packing module.

REEL

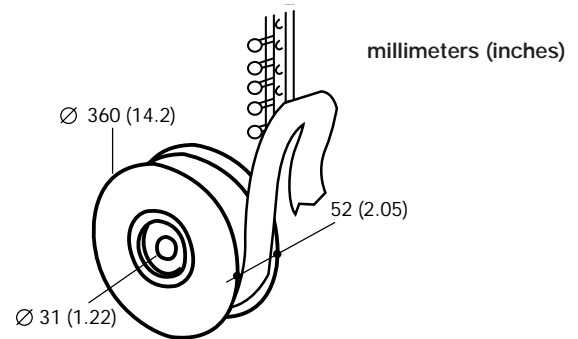

LEADS CONFIGURATION AND PACKAGING SUFFIXES

The tables below indicate the suffixes to be specified when ordering kink and packaging types. For devices on tape, it is necessary to specify the height (H or Ho) which is the distance between the tape axis (sprocket holes) and the sitting plane on the printed circuit board.

– Straight leads

H represents the distance between the sprocket holes axis and the bottom plane of component body (base of resin or base of stand off).

– Kinked leads

Ho represents the distance between the sprocket holes axis and the base of the knee.

Types	VE 07/09 - VF 05/07 (VE13 - VF10 ≤ 320 V _{rms} upon request)					
Leads	Straight		Kinked (type 1)		Kinked (type 2)	
Dimensions						
Packaging	AMMOPACK	REEL	AMMOPACK	REEL	AMMOPACK	REEL
H/Ho = 16 ± 0.5	DA(*)	DB(*)	DQ(**)	DR(**)	D7(**)	D5(**)
H/Ho = 18 -0/+2	DC(**)	DD(**)	DS	DT	D8	D6

Types	VE 13/17 - VF 10/14					
Leads	Straight		Kinked (type 1)		Kinked (type 2)	
Dimensions						
Packaging	AMMOPACK	REEL	AMMOPACK	REEL	AMMOPACK	REEL
H/Ho = 16 ± 0.5	EA(*)	EN(*)	EC(**)	EF(**)	EQ(**)	ER(**)
H/Ho = 18 -0/+2	EB(**)	ED(**)	EG	EH	ES	ET

(*) DA, DB, EA, EN suffixes are not available for varistors with V_{RMS} 300V are available only upon request for other types.

(**) Preferred versions according to IEC 286-2

Zinc Oxide Varistors

Packaging

PACKAGING QUANTITIES

Type	Bulk	AMMOPACK	REEL
VE07 - VF05 all	1500	1500	1500
VE09 - VF07 < 230 V _{RMS}	1000	1500	1500
VE09 - VF07 ≥ 230 V _{RMS} ≤ 300 V _{RMS}	1000	1000	1000
VE09 - VF07 > 300 V _{RMS}	750	1000	1000
VE13 - VF10 ≤ 230 V _{RMS}	500	750	750
VE13 - VF10 > 230 V _{RMS} ≤ 300 V _{RMS}	500	500	500
VE13 - VF10 > 300 V _{RMS}	500	—	—
VE17 - VF14 ≤ 230 V _{RMS}	500	750	750
VE17 - VF14 > 230 V _{RMS} ≤ 300 V _{RMS}	500	500	500
VE17 - VF14 > 300 V _{RMS}	500	—	—
VE24 - VF20	250	—	—

IDENTIFICATION - TRACEABILITY

On the packaging of all shipped varistors, you will find a bar code label.

This label gives systematic information on the type of product, part number, lot number, manufacturing date and quantity.

An example is given below:

(H)Lot: 6B2960304407 /040 960108 ← Lot number
 ← Manufacturing date (YYMMDD)
(Q)Qty: 250 ← Quantity per packaging
(2W)TPC-PN: VE13M03850K -- ← Part number

This information allows complete traceability of the entire manufacturing process, from raw materials to final inspection.

This is extremely useful for any information request.