

Evaluation Board for the **AD7284** 8-Channel, Li-Ion Battery Monitoring System

FEATURES

- Full featured evaluation board for the **AD7284**
- Separate master and slave evaluation kits
- Direct current daisy chain or isolated daisy-chain options
- Master configuration kit
 - EVAL-SDP-CB1Z** compatible
 - Standalone capability
 - Isolated power and interface
- Slave configuration kit
 - To be used in conjunction with an **AD7284** master evaluation kit
 - Direct interface to the **AD7284** master board
 - Daisy-chain capability for chains of up to 20 devices
- PC software for control and data analysis when used with the Analog Devices, Inc.,SDP, **EVAL-SDP-CB1Z**

EVALUATION KIT CONTENTS

- Four evaluation kits are available for the **AD7284**
- Isolated daisy chain kits
 - EV-AD7284TMSDZ** kit
 - EV-AD7284TMSDZ** master evaluation board
 - USB cable
 - 9 V (2 A) power supply
- Direct current daisy chain kits
 - EV-AD7284MSDZ** kit
 - EV-AD7284xSDZ** master evaluation board
 - USB cable
 - 9 V (2 A) power supply
 - EV-AD7284SSDZ** kit
 - EV-AD7284xSDZ** slave evaluation board
 - EV-AD7284SSSDZ** kit, containing an **AD7284** mini transformer isolated slave board.

EQUIPMENT NEEDED

EVAL-SDP-CB1Z SDP

SOFTWARE NEEDED

- Evaluation software for the **AD7284** (download this software from the **EVAL-AD7284** page)
- AD7284 Application Installer**
- AD7284 Full Installer**

GENERAL DESCRIPTION

The **AD7284** is a complete, 14-bit resolution, lithium ion (Li-Ion) battery monitoring system, integrating multiple voltage and auxiliary analog-to-digital converter (ADC) input channels. Full details about the device are available in the **AD7284** data sheet from Analog Devices, which should be consulted in conjunction with this user guide when using the evaluation kit.

This user guide describes the four evaluation kits for the **AD7284**: the **EV-AD7284MSDZ**, **EV-AD7284TMSDZ** (containing the **AD7284** master board), **EV-AD7284SSDZ**, and **EV-AD7284SSSDZ** (containing the **AD7284** mini transformer isolated slave board).

Figure 1 and Figure 2 show an overview of the evaluation boards.

On-board components on the master board include isolated power and interface using the **ADuM1201** and the **ADuM5401** digital isolators, and power using the **ADP3303** and the **ADP7104** regulators.

The **AD7284** master board is used in conjunction with the **EVAL-SDP-CB1Z** system demonstration platform (SDP) board available from Analog Devices, which must be purchased separately from the evaluation board.

TABLE OF CONTENTS

| | | | |
|--|---|---|----|
| Features | 1 | Master Board Supply and Communication Options..... | 7 |
| Evaluation Kit Contents..... | 1 | Connectors Summary..... | 8 |
| Equipment Needed..... | 1 | Master vs. Slave Configuration..... | 8 |
| Software Needed..... | 1 | Evaluation Board Software..... | 9 |
| General Description | 1 | Software Installation | 9 |
| Revision History | 2 | Software Installation Procedures..... | 9 |
| Functional Block Diagrams..... | 3 | Evaluation Board Setup Procedures | 11 |
| Evaluation Kits Description | 4 | Launching the Evaluation Board Software..... | 11 |
| Evaluation Board Features..... | 6 | Possible Errors when Launching the Evaluation Board Software | 12 |
| Caution In a High Voltage Condition..... | 6 | Software Operation | 13 |
| Cell Monitor and Balancing Circuits..... | 6 | AD7284 Evaluation GUI | 14 |
| Temperature Measurement Capability | 6 | | |
| Board to Board Communication..... | 6 | | |

REVISION HISTORY

5/2017—Revision A: Initial Version

FUNCTIONAL BLOCK DIAGRAMS

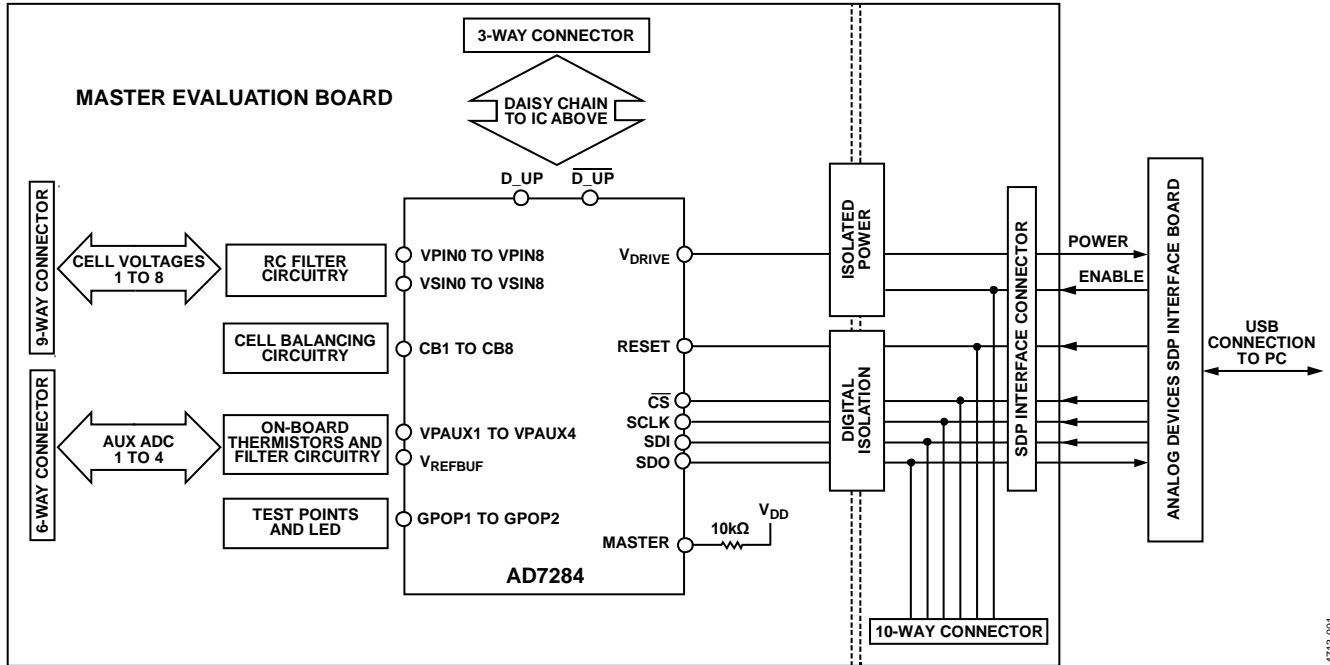

Figure 1. Overview of Master Evaluation Board (Analog Devices SDP Interface Board Sold Separately)

147713-001

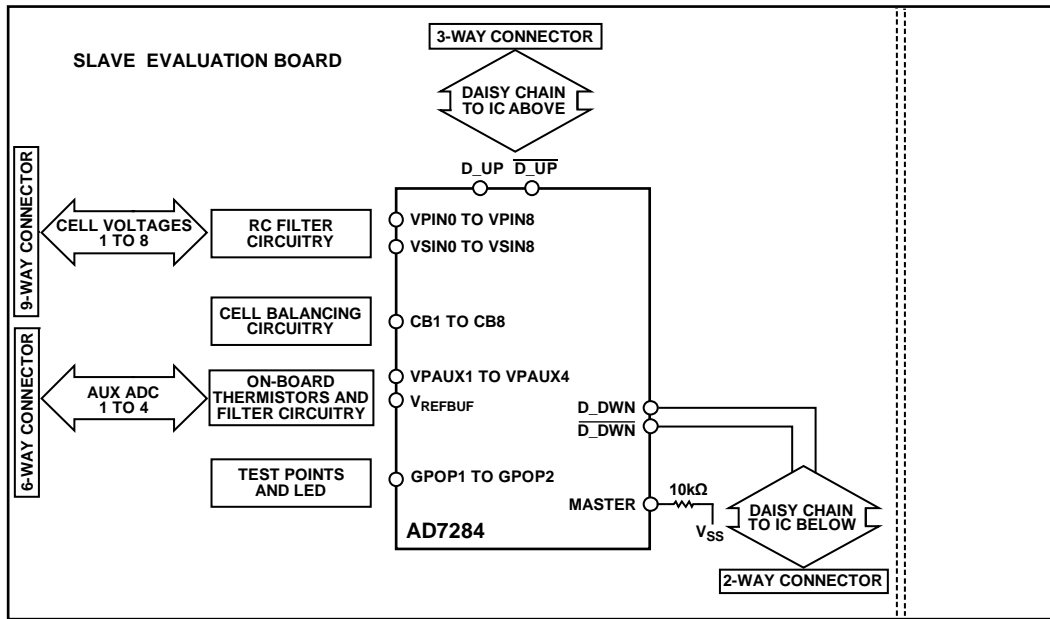

Figure 2. Overview of Slave Evaluation Board

147713-002

EVALUATION KITS DESCRIPTION

Five evaluation kits are available, as described in Table 1.

Table 1. Evaluation Kits Models

| Model | Description |
|--------------------------------|---|
| EV-AD7284MSDZ | AD7284 master evaluation kit (direct current daisy-chain configuration) |
| EV-AD7284TMSDZ | AD7284 master evaluation kit (isolated daisy-chain configuration) |
| EV-AD7284SSDZ | AD7284 slave evaluation kit (direct current daisy-chain configuration) |
| EV-AD7284SSSDZ | AD7284 mini transformer isolated slave board |

The master evaluation kits contain an [AD7284](#) evaluation board, where the [AD7284](#) device is configured in master mode with a 9 V power supply and a USB cable.

The slave evaluation kits contain an [AD7284](#) evaluation board, where the [AD7284](#) device is configured in the slave mode.

A slave evaluation kit in a direct current daisy-chain configuration must be used in conjunction with a master evaluation kit in the same configuration.

A slave evaluation kit with an isolated daisy-chain configuration must be used in conjunction with a master evaluation kit in the same configuration.

The two evaluation boards (master and slave) are based on the same printed circuit board (PCB), populated with a different bill of materials.

Figure 3 shows a master board and slave board connected via the daisy chain in direct current daisy-chain configuration. The master board is responsible for communication with the [EVAL-SDP-CB1Z](#) board or with an external digital signal processor (DSP) or microprocessor. The slave board is supplied from the battery cells only and communicates with other boards connected in series in the daisy chain.

The evaluation software communicates with the master via the [EVAL-SDP-CB1Z](#) controller board. [EVAL-SDP-CB1Z](#) is not available as part of the evaluation kits and is sold separately.

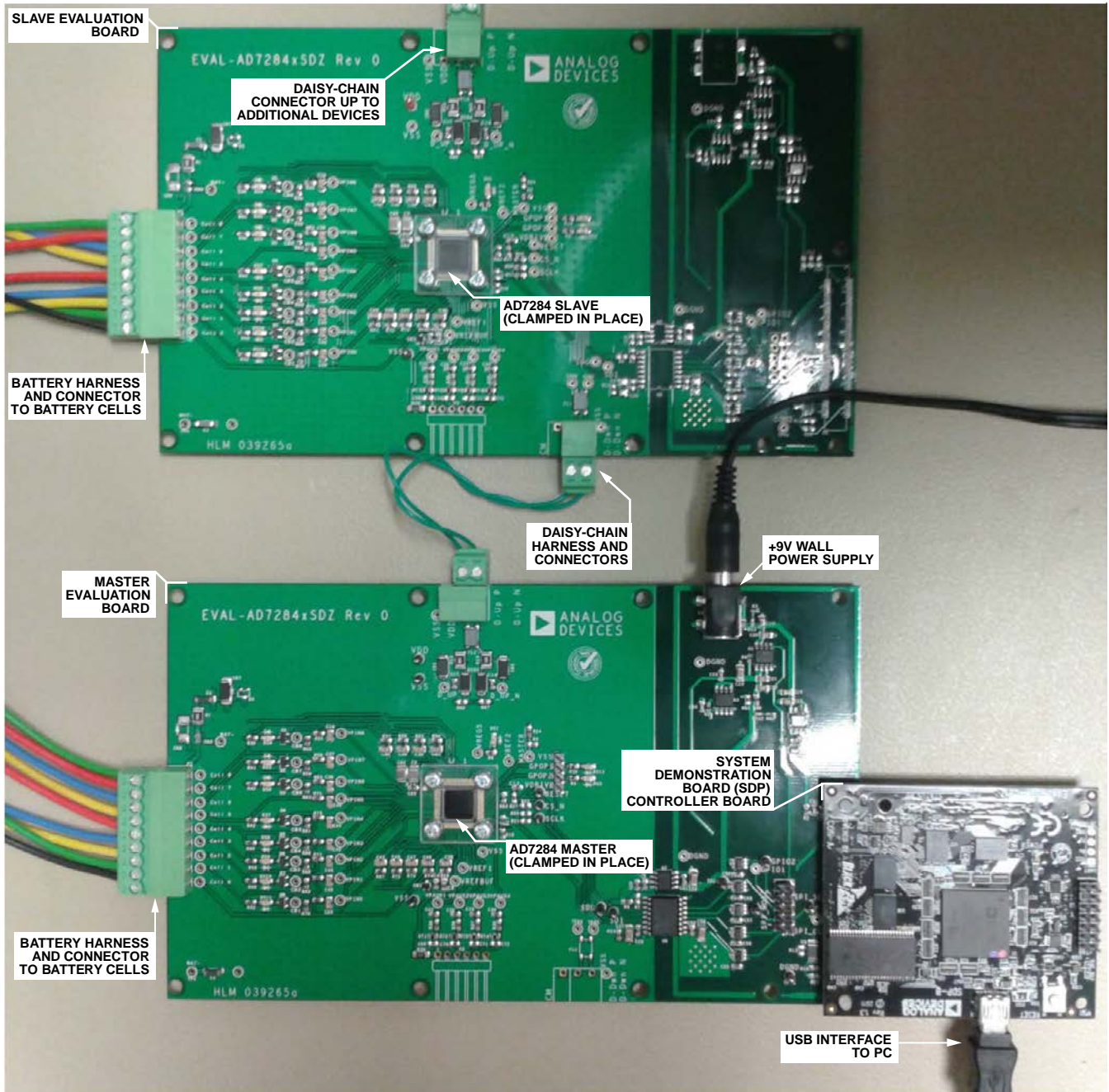

Figure 3. Configuration Showing a Two Device Daisy-Chain Setup

14713-003

EVALUATION BOARD FEATURES

CAUTION IN A HIGH VOLTAGE CONDITION

When multiple boards are daisy-chained together and connected to battery packs, the voltage quickly increases above safe voltage levels. Extreme caution must be taken to ensure safety for the user. It is strongly advised to power down and disconnect the boards from the battery packs when not in use.

CELL MONITOR AND BALANCING CIRCUITS

The evaluation boards connect to the battery cells via the P1 connector. The AD7284 evaluation board is designed to operate over a stack voltage range of 10 V to 40 V.

The slave board is entirely supplied from the battery cells. The master board supply options are discussed in the Master Board Supply and Communication Options section.

Low-pass filters are on the evaluation board for the primary and secondary path.

For demonstration purposes, the cell balancing metal-oxide semiconductor field effect transistor (MOSFET) are connected to LEDs, so activity on the cell balancing circuit is visible. A footprint for resistors is available on the bottom layer of the board.

TEMPERATURE MEASUREMENT CAPABILITY

On-Board Resistance Temperature Detectors (RTDs)

The VPAUXx inputs are connected by default to on-board 33 kΩ RTDs.

Off-Board RTDs

The P2 connector offers the option to connect off-board RTDs, as shown in Table 2.

Table 2. Pin Designations for the P2 Six Way Connector

| Pin No. | Connection |
|---------|---------------------|
| 1 | V _{REFBUF} |
| 2 | VPAUX1 |
| 3 | VPAUX2 |
| 4 | VPAUX3 |
| 5 | VPAUX4 |
| 6 | V _{SS} |

Capacitor footprints close to the P2 connector can be populated when using an off-board RTD configuration.

BOARD TO BOARD COMMUNICATION

Two configuration options are available: direct current or isolated daisy-chain configuration. The AD7284 evaluation kit is configured for direct current daisy-chain communication. In a chain, the D_UP and D_UP pins of an AD7284 device must connect to the D_DWN and D_DWN pins, respectively, of the preceding AD7284 device within that chain, shown in Figure 4.

The pin designations for the P3 and P4 connectors are shown in Table 3 and Table 4.

Table 3. Pin Designations for the Two Way Connector, P3 (Up)

| Pin No. | Connection |
|---------|------------|
| 1 | D_UP |
| 2 | D_UP |
| 3 | VDD |

Table 4. Pin Designations for the Two Way Connector, P4 (Down)

| Pin No. | Connection |
|---------|------------|
| 1 | CCM |
| 2 | D_DWN |
| 3 | D_DWN |

P4 is not populated on the master board.

Direct Current Daisy-Chain

Figure 4 shows a direct current daisy-chain configuration.

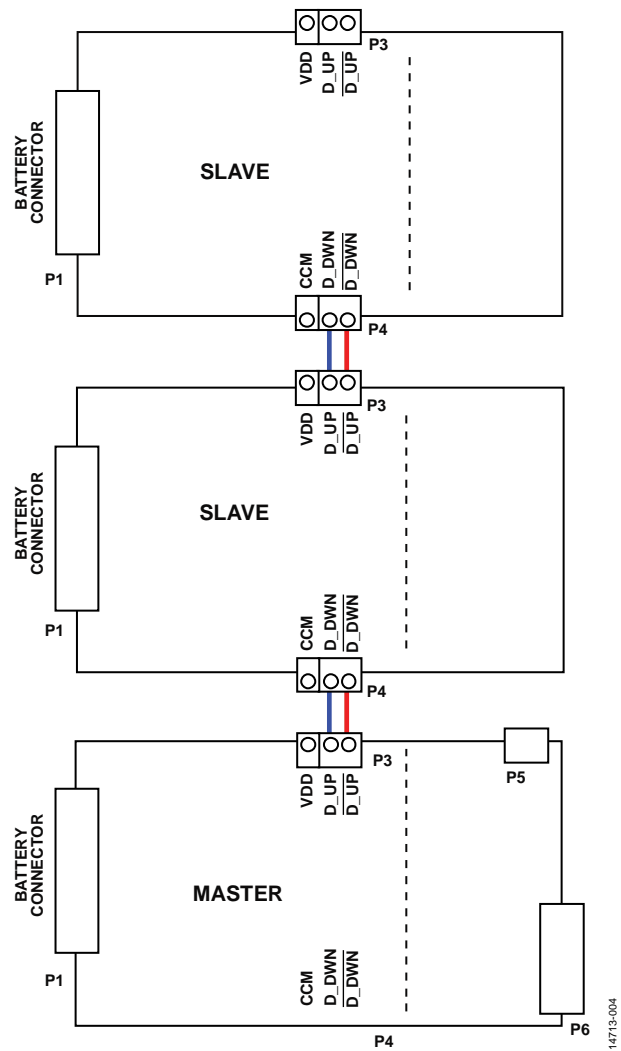

Figure 4. Direct Current Daisy-Chain Configuration of Master with Two Slaves for Direct Current Daisy-Chain Configuration

Isolated Daisy Chain

Figure 5 shows an isolated daisy-chain configuration.

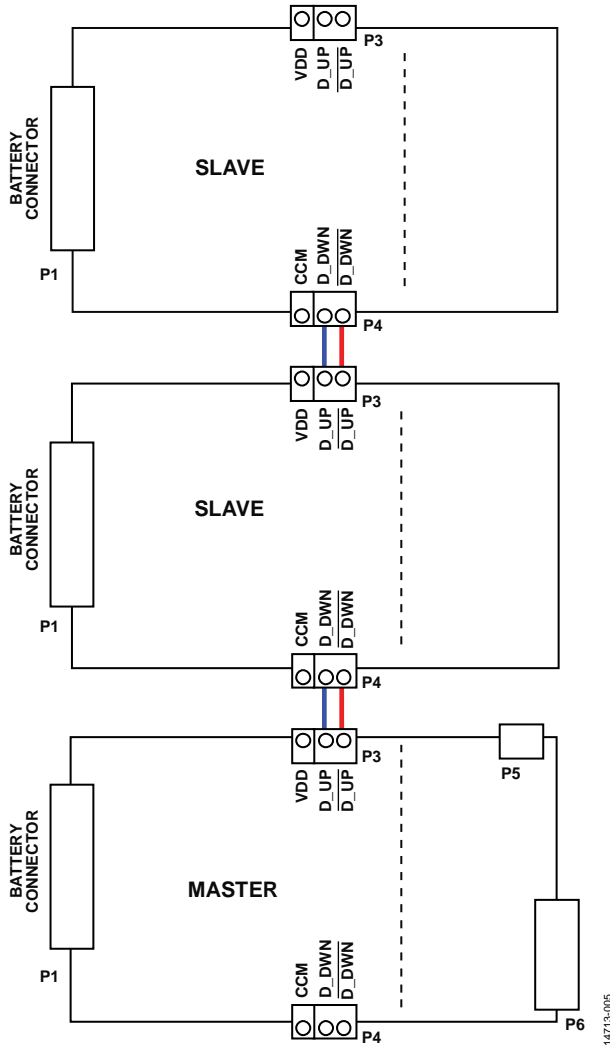

Figure 5. Configuration for Isolated Daisy Chain

MASTER BOARD SUPPLY AND COMMUNICATION OPTIONS

The master board is responsible for the communication between the chain of AD7284 devices and the host controller. Isolation is provided between the AD7284 master and the host controller through the ADuM5401 and ADuM1201.

A 9 V wall power supply connected to P5 (barrel type) is required to provide power to the low voltage digital circuitry. The serial peripheral interface (SPI) can operate at 3.3 V or 5 V. The default option selected is 5 V, but can be changed via a resistor link (see Table 7).

The isolated high voltage side can be powered directly from battery cells or a power supply configured with a resistor stack to emulate battery cells.

The following two options are provided on the master evaluation board to communicate with the chain of AD7284 devices via the SPI:

- Using an Analog Devices controller board (EVAL-SDP-CB1Z).
- In a standalone mode, with connections to an external host.

The master board is configured with the assumption that the Analog Devices controller board is used with the master board.

Operating with the EVAL-SDP-CB1Z Board

This EVAL-SDP-CB1Z controller board is available from Analog Devices. A standard USB cable is included in the EVAL-SDP-CB1Z package for communication between EVAL-SDP-CB1Z and the PC.

The 120 way connector on the EVAL-AD7284MSDZ plugs directly into the 120 way connector (CON A) on the EVAL-SDP-CB1Z board. The EVAL-AD7284MSDZ evaluation board provides the power supply for the EVAL-SDP-CB1Z board. Table 5 gives a description of the pins on the 120 way connector that interfaces between the EVAL-SDP-CB1Z board and the EVAL-AD7284MSDZ.

Table 5. Pin Designations for SDP Connector P6

| Signal | Description |
|----------|--|
| SPI_SS | SPI chip select. This output is connected to the CS pin of the AD7284, via isolation, to frame the serial data transfer. |
| SPI_CLK | SPI clock. This output is connected to the SCLK pin of the AD7284, via isolation, to clock the serial data transfer. |
| SPI_MISO | SPI master in, slave out data. This input is connected to the SDO pin of the AD7284 via isolation. |
| SPI_MOSI | SPI master out, slave in data. This output is connected to the SDI pin of the AD7284 via isolation. |
| GPIO2 | General-purpose input/output. This output is connected to the RESET pin of the AD7284 via isolation. |
| GPIO4 | General-purpose input/output. This output disables the power to the ADuM5401 and ADuM1201 on the evaluation board. |
| VIN | Digital 5 V supply. This 5 V supply provides power to the EVAL-SDP-CB1Z and to the low voltage side of the master evaluation boards. |
| DGND | Digital ground. These lines are connected to the ground plane on the low side of the evaluation board. |

Operating with an External Host

The following two options are available for interfacing with the evaluation board:

- P6 (120 way connector)
- P7 (eight way connector, not inserted)

The pin designations for the P7 connector are shown in Table 6.

Table 6. Pin Designations for the Eight Way Connector, P7

| Pin No. | Description |
|---------|--|
| 1 | CS |
| 2 | SCLK |
| 3 | SDI |
| 4 | SDO |
| 5 | RESET; active high |
| 6 | Control signals enable; active high |
| 7 | External supply option |
| 8 | GND |
| 9 | V _{DRIVE} enable; active high |
| 10 | GND |

The low voltage digital circuit can be supplied from the 9 V power supply or from a 3.3 V or 5 V (default) external supply on P7.

Table 7. Master Board, Low Voltage Supply Options

| Supply Voltage | Component |
|---|----------------------------------|
| Cold Side (DVDD) | |
| 5 V | R80 inserted, R81 open (default) |
| 3.3 V | R81 inserted, R80 open |
| Hot Side (V _{DRIVE}) | |
| 5 V | R6 inserted, R7 open |
| 3.3 V | R7 inserted, R6 open |
| 3.3 V Control Signals on P7, with 5 V Supply on Cold Side | R88 inserted, R84 open |

The V_{DRIVE} signal (supply for the SPI interface of the master) is turned on by enabling the regulator output powering up the low side of the *isoPower*® ADuM5401. This feature is available from Pin 9 of P7, or GPIO4 from the SDP connector (P6) (see Table 5).

Master Board Ground Planes

Extensive ground planes minimize the effect of high frequency noise interference. One ground plane, DGND, is provided for the low voltage digital circuitry, the ADP3303, ADP7104 regulators, the low side of the ADuM5401, and the ADuM1201 isolators. A separate ground plane, isolated from the DGND plane, is provided for the AD7284 on the evaluation board.

CONNECTORS SUMMARY

There are seven connector footprints on the evaluation boards, as shown in Table 8.

Table 8. Connector Summary

| Reference Designator | Description | Comment |
|----------------------|--|-------------------------------|
| P1 | Nine way connector for eight Li-Ion battery cells | |
| P2 | Six way connector for four primary auxiliary ADC inputs and V _{REFBUF} bias | |
| P3 | External two way (standard daisy chain) or three way (isolated daisy chain) connector to allow daisy-chaining of evaluation boards | |
| P4 | External two way (standard daisy-chain) or three way (isolated daisy chain) connector to allow daisy-chaining of evaluation boards | Populated on the slave board |
| P5 | 9 V wall power supply connector (barrel type) to power the low voltage digital circuitry | Populated on the master board |
| P6 | 120 way connector for SDP interface connections | Populated on the master board |
| P7 | Eight way connector on nonisolated side for connection to external host processor | Populated on the master board |

MASTER vs. SLAVE CONFIGURATION

Table 9 lists the main differences between the master and slave configurations.

Table 9. Master vs. Slave Configuration

| Function | Master | Slave |
|--------------------|--------------------------------------|--|
| MASTER | R24 pulled up to VDD | R5 pulled down to V _{SS} |
| RESET | Controlled by the host | R83 pulled down to V _{SS} |
| V _{DRIVE} | Controlled by the host | R27 shorts V _{DRIVE} to VREG5 |
| SPI | Controlled by the host | R22, R20, and R21 links to V _{SS} for CS, SCLK, and SDI |
| D_DWN and D_DWN | R17 and R18 links to V _{SS} | FL1, R10, R11, D1, CR1, C14, and P4 populated |

EVALUATION BOARD SOFTWARE SOFTWARE INSTALLATION

The [AD7284](#) evaluation software is available to download from the [EVAL-AD7284](#) page.

The following two files are available to download, depending on the user requirements:

- Evaluation software full installation. The [AD7284 Full Installer](#) full installation software includes the [AD7284](#) application software, LabVIEW® run time software, SDP drivers, and .NET4.
- Evaluation software update; the [AD7284 Application Installer](#) applies to the [AD7284](#) application only, and is recommended for software upgrades.

SOFTWARE INSTALLATION PROCEDURES

The following installation steps are for the evaluation software full installation. There are two parts to the evaluation software full installation, which must be performed in the following order:

1. [AD7284 Full Installer](#) evaluation software full installation (installed first).
2. [EVAL-SDP-CB1Z](#) SDP board drivers installation and any required .NET4 components.

Warning

The evaluation board software and drivers must be installed before connecting the evaluation board and the [EVAL-SDP-CB1Z](#) board to the USB port of the PC to ensure the evaluation system is correctly recognized when it is connected to the PC.

Installation Part 1—[AD7284 Evaluation Board Software](#)

1. Close all open applications.
2. After extracting the files from the compressed files described in the Software Installation section, navigate to the **Setup.exe** file to initiate the installation.
3. With the board disconnected from the PC, right click on **Setup.exe**, select **Run as Administrator** from the pop-up window, and follow the on screen instructions. On a Windows® 7 operating system, a dialog box appears as shown in Figure 6.

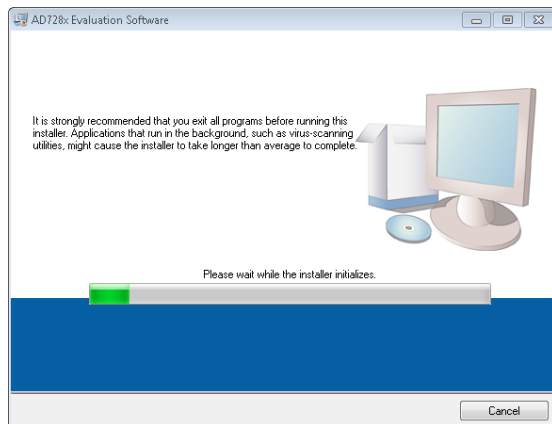

Figure 6. First Step of the Software Installation

4. As the National Instruments run-time engines are installed to support the [AD7284](#) software, a license agreement opens. Read the agreement, then select **I accept the License Agreement.** and click **Next.**

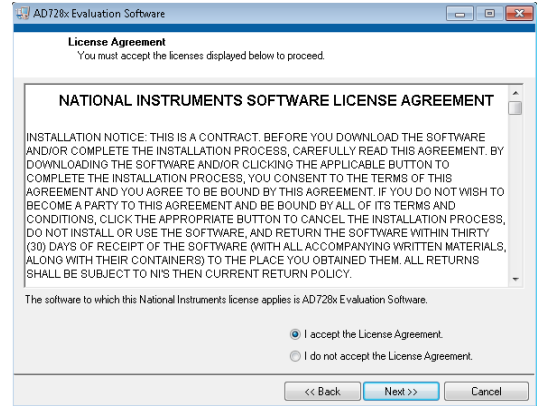

Figure 7. Accepting the National Instruments License Agreement

5. The default location of the installation is shown in Figure 8. It is recommended not to change from this location. Click **Next.**

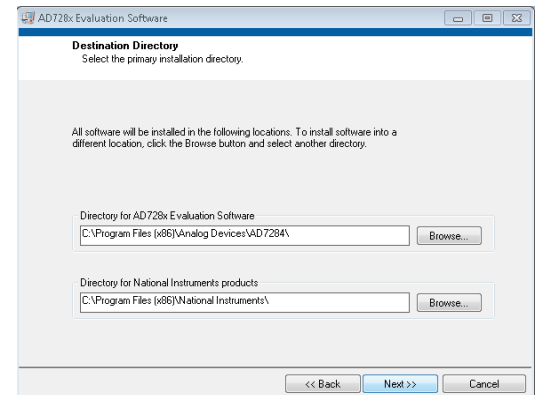

Figure 8. Default Destination Directory

6. A summary of the installation is displayed. Click **Next** to continue.

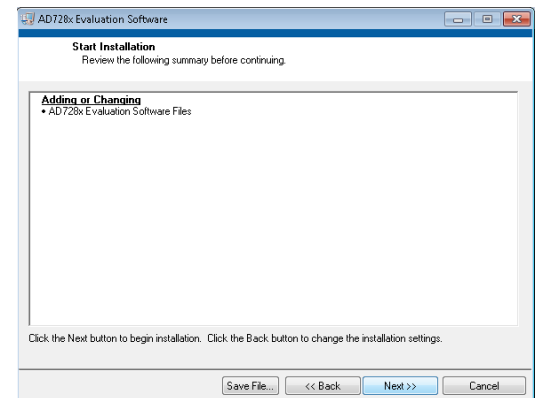

Figure 9. Reviewing a Summary of the Installation

- A dialog box informs the user of the progress of the installation.

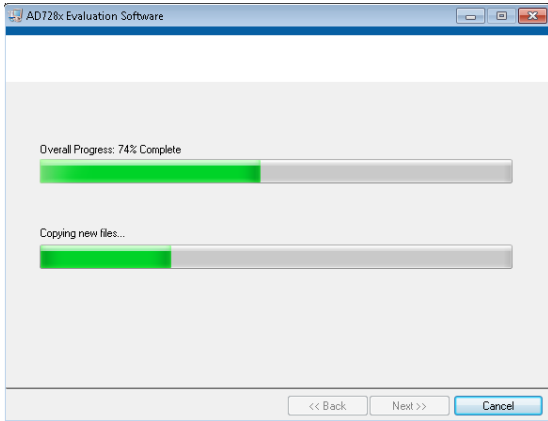

Figure 10. Installation in Progress

- A dialog box informs the user when the installation is complete. Click **Next**.

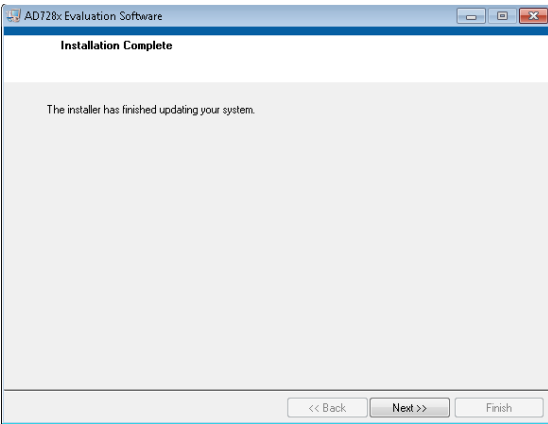

Figure 11. Indication that the Installation Is Complete

- The software may request to restart the PC at this time. Do not restart the PC until the installation is complete. Click **Restart Later**.

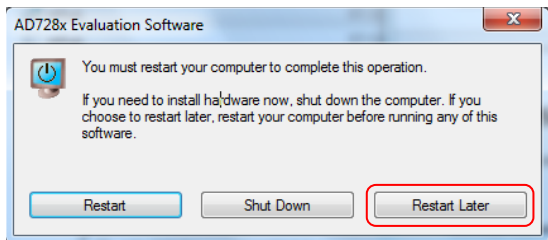

Figure 12. Starting the Installation

Installation Part 2—EVAL-SDP-CB1Z Driver Installation

After the installation of the evaluation board software is complete, a welcome window is displayed for the installation of the EVAL-SDP-CB1Z SDP board drivers.

- With the EVAL-SDP-CB1Z board still disconnected from the USB port of the PC, ensure all other applications are closed and click **Next**.



Figure 13. Beginning the SDP Driver Installation

- Select a location to install the drivers, and then click **Next**.

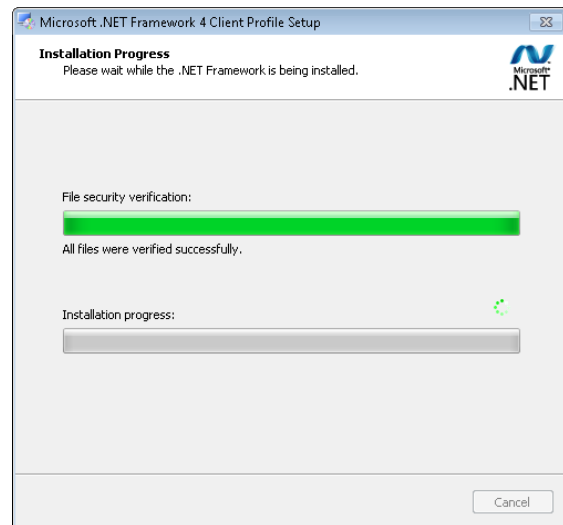

Figure 14. Initializing the .NET4 Installation as Part of the SDP Driver Installation

- Click **Install** to confirm the installation of the drivers.

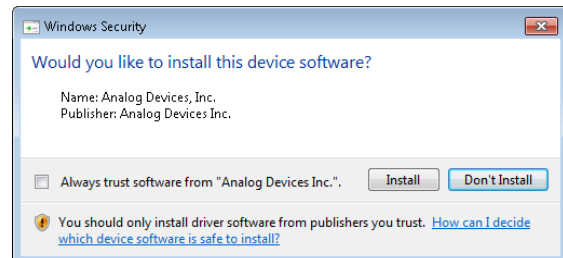

Figure 15. Grant Permission to Install Drivers

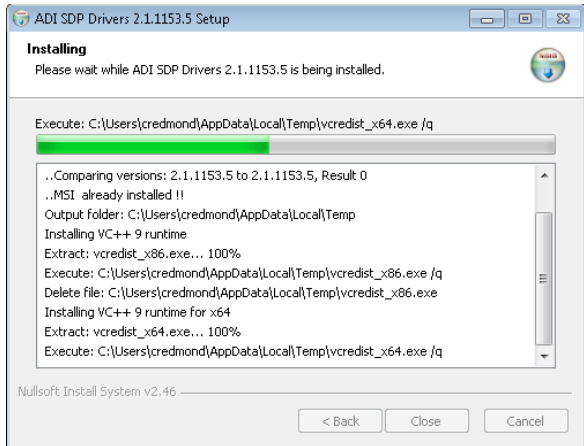

Figure 16. SDP Driver Install in Progress

- To complete the driver installation, click **Close** to close the installation wizard.

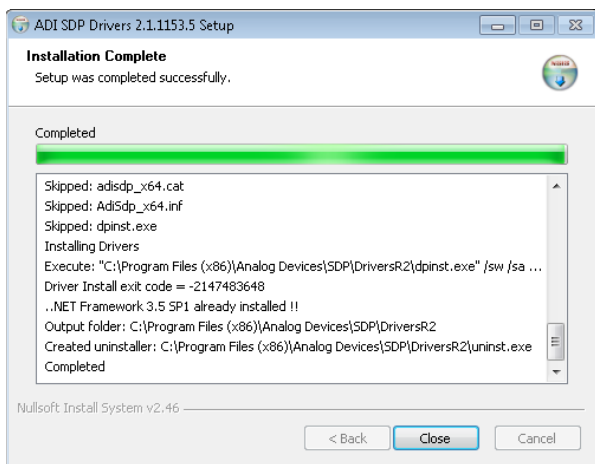

Figure 17. SDP Driver Installation Complete

- Before using the evaluation board, you must restart the PC.

EVALUATION BOARD SETUP PROCEDURES

The **AD7284** evaluation board connects to the **EVAL-SDP-CB1Z** SDP board. The **EVAL-SDP-CB1Z** board is the controller board, which is the communication link between the PC and the evaluation board.

After following the instructions in the Software Installation Procedures section, set up the evaluation and SDP boards as detailed in this section.

Configuring the Evaluation and SDP Boards

After installation is complete, take the following steps:

- Connect the 9 V wall power supply included in the evaluation kit to Connector P5 on the evaluation board.
- Connect the **EVAL-SDP-CB1Z** board (Connector A) to the **AD7284** evaluation board (Connector J8).
- Connect the **EVAL-SDP-CB1Z** board to the PC USB port using the supplied USB cable.

Allow the new Found Hardware Wizard to run. This detects and loads the drivers for the **EVAL-SDP-CB1Z** board.

When the evaluation system is detected, proceed through any dialog boxes that appear. This completes the installation.

The **AD7284** evaluation software and hardware are designed such that all conversion results can be captured by the **EVAL-SDP-CB1Z** board and uploaded through the USB port to the PC. If there is a lot of activity on the USB port, the speed of the data transfer can be reduced. In this case, the user must disconnect other external devices that may be using the USB port, increase the conversion loop interval, or decrease the number of samples to ease the requirement on the USB port. Note that the transfer of data from the **EVAL-SDP-CB1Z** to the PC is slower when connecting to a USB 1.1 port than it is when connecting to a USB 2.0 port.

LAUNCHING THE EVALUATION BOARD SOFTWARE

To run the software, perform the following steps:

- From the **Start** menu, Select **All Programs > Analog Devices > Analog Devices – AD7284 > AD7284 GUI**. The main window of the software graphical user interface (GUI) displays, shown in Figure 24.
- When the software starts running, it searches for hardware connected to the PC. The **Hardware Select** dialog box indicates when the evaluation board and **EVAL-SDP-CB1Z** board are detected. Click **Select** to continue.

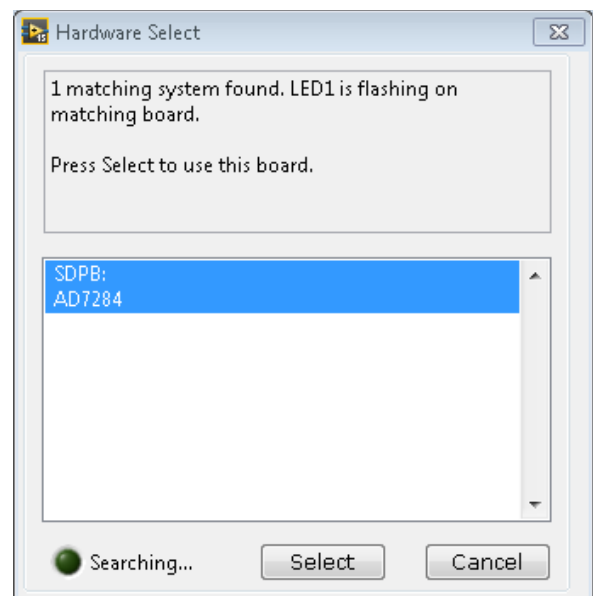

Figure 18. Software Finds the Evaluation Board and **EVAL-SDP-CB1Z** Board

POSSIBLE ERRORS WHEN LAUNCHING THE EVALUATION BOARD SOFTWARE

If the incorrect version of the LabVIEW run-time system is installed as part of the AD7284 evaluation board software installation, the warning message shown in Figure 19 displays. To resolve this issue, the user must install the evaluation software full installation file (see the Software Installation Procedures section).

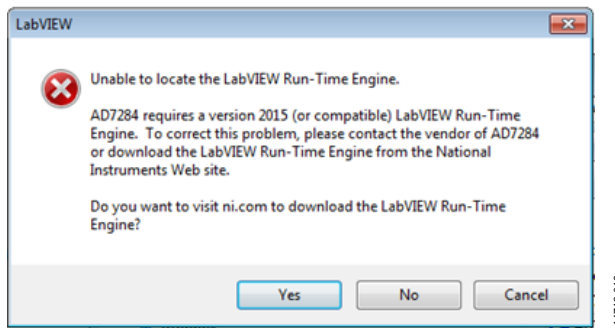

Figure 19. LabVIEW Run-Time Warning Displayed if the National Instruments Support Software is Not Installed Correctly

If the software displays the message shown in Figure 20, the user must reset the EVAL-SDP-CB1Z board by pressing the RESET button on the EVAL-SDP-CB1Z board (next to the USB connector). The window displayed in Figure 20 opens, followed shortly by the window displayed in Figure 18.

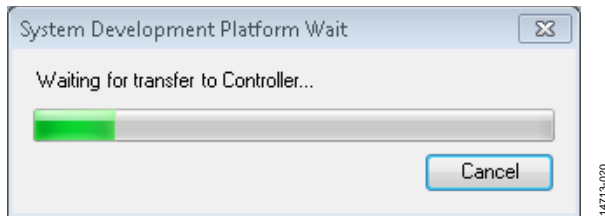

Figure 20. SDP Platform Transfer Window

If the EVAL-SDP-CB1Z board is not connected to the USB port when the software is launched, a connectivity error displays (see Figure 21). Connect the EVAL-SDP-CB1Z board to the USB port of the PC, wait a few seconds, click **Select**, and follow the instructions, as shown in Figure 18.

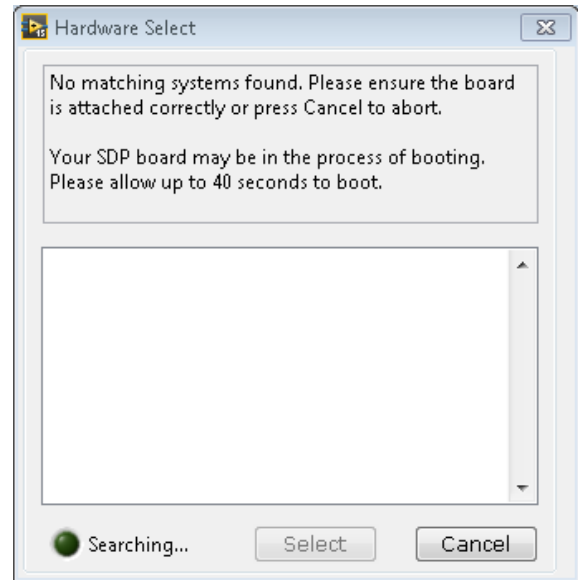

Figure 21. Connectivity Error Alert

If the boards cannot be found, disconnect the 9 V supply from the evaluation board and the USB cable from the EVAL-SDP-CB1Z board, reconnect the USB cable, wait a few seconds, reconnect the 9 V supply, and then restart the AD7284 GUI as described in Launching the Evaluation Board Software section.

If power (>10 V) is not supplied to the P1 battery connector, the device does not operate normally after selecting **Connect** on the GUI.

In the event that the AD7284 evaluation board does not have power supplied to the P1 battery connector, clicking the **Connect** button results in the alert show in Figure 22.

If power is available and connected at P1, select **Retry**; the user must select **Connect** to restart the initialization process.

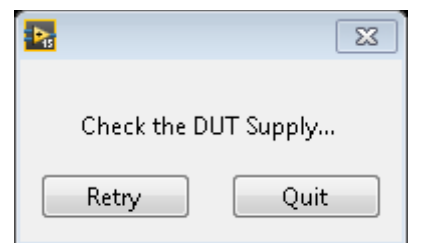

Figure 22. Warning to Indicate the AD7284 Board Cannot be Found

If the user continues to experience difficulties detecting the evaluation board, check that the drivers and the SDP board are recognized in the **Device Manager** of the PC. The Device Manager can be found in the following location: **Control Panel > System > Device Manager**.

The SDP board appears under **ADI Development Tools** as shown in Figure 23.

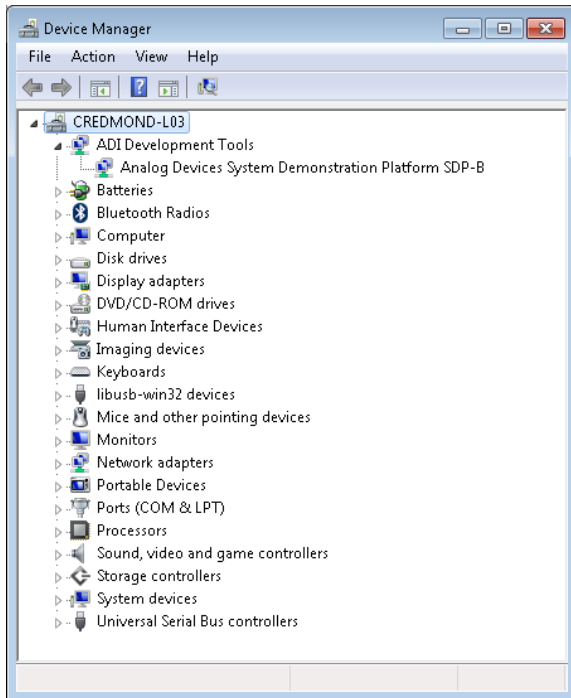

Figure 23. Confirming the SDP Board is Connected in the Device Manager

SOFTWARE OPERATION

With the hardware set up, the software can control the [EVAL-SDP-CB1Z](#) and the [AD7284](#) evaluation board. From the **Start** menu, select **All Programs > Analog Devices > Analog Devices – AD7284 > AD7284 GUI**. The main window of the software GUI displays, shown in Figure 24. The main function of this window is to allow the user to read samples from the evaluation board and display them.

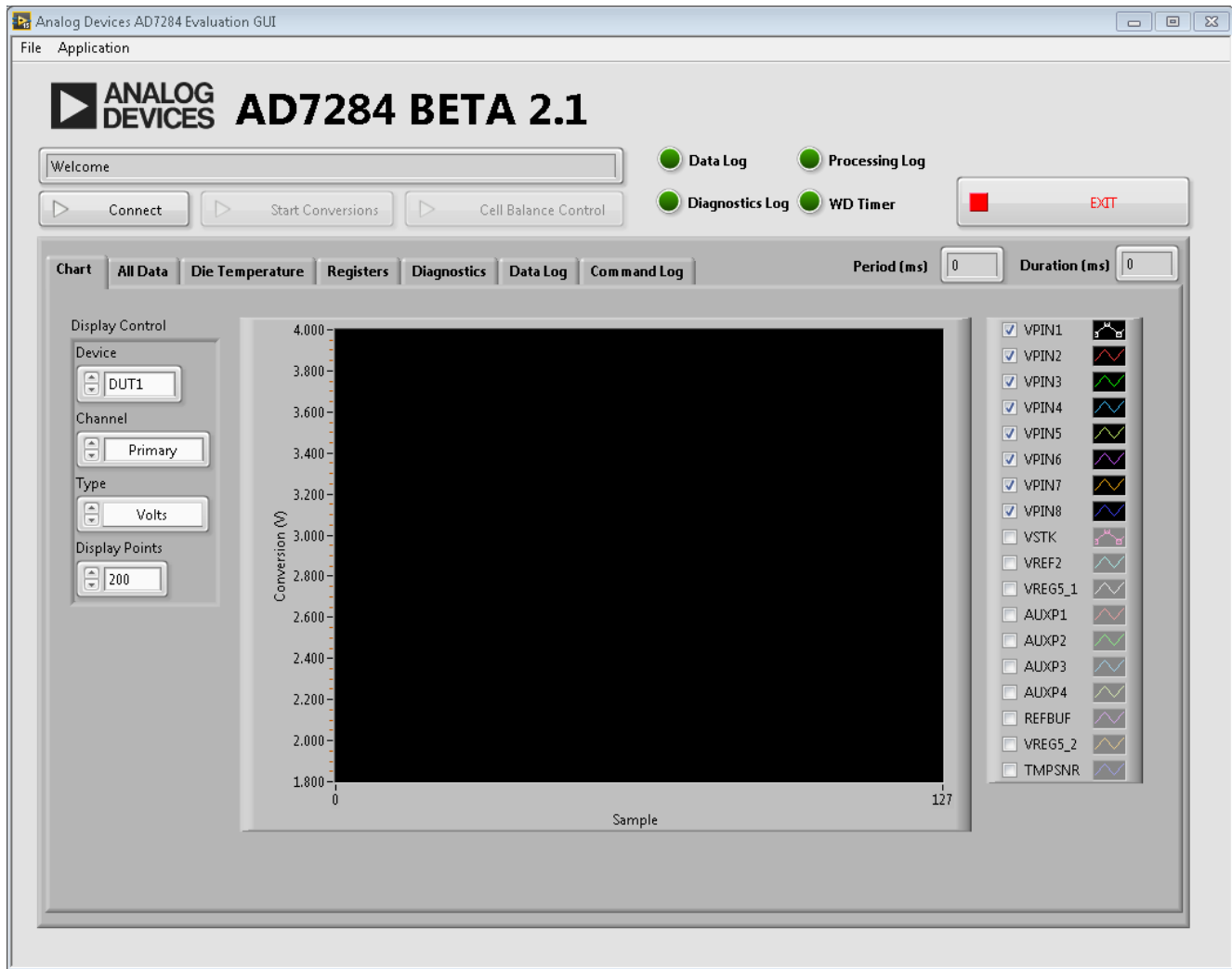

Figure 24. Evaluation Software Main Window

AD7284 EVALUATION GUI

The evaluation software can be divided into the following three main sections:

- Front panel control. This control enables the basic operation of the device.
- Display tabs. These tabs enable the user to view and recall data from the system.
- Menu bar. The menu bar controls data acquisition and the logging of data.

Front Panel Control

The main controls used to operate the [AD7284](#) chain are found on the front panel.

Connect

Click **Connect** to connect the software to the [AD7284](#) system. This action starts the procedure to detect the [EVAL-SDP-CB1Z](#) board and initialize the chain of devices. After the chain is configured, a message similar to that shown in Figure 25 appears. In this example, the master address is the default value of 0x01 and three devices are detected and configured. The additional front panel buttons, **Start Conversions** and **Cell Balance Control**, are now enabled.

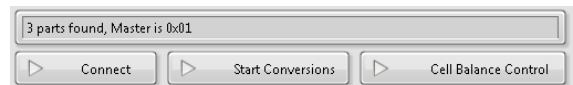

Figure 25. Message Indicating That a Chain of Three Devices is Detected

Start Conversions

Click **Start Conversions** to initiate the configured conversion sequence.

Cell Balance Control

Click **Cell Balance Control** (see Figure 24) to display the Cell Balance Control window, shown in Figure 26.

The **AD7284 CB Display** window controls the cell balance (CB) functions of the **AD7284**.

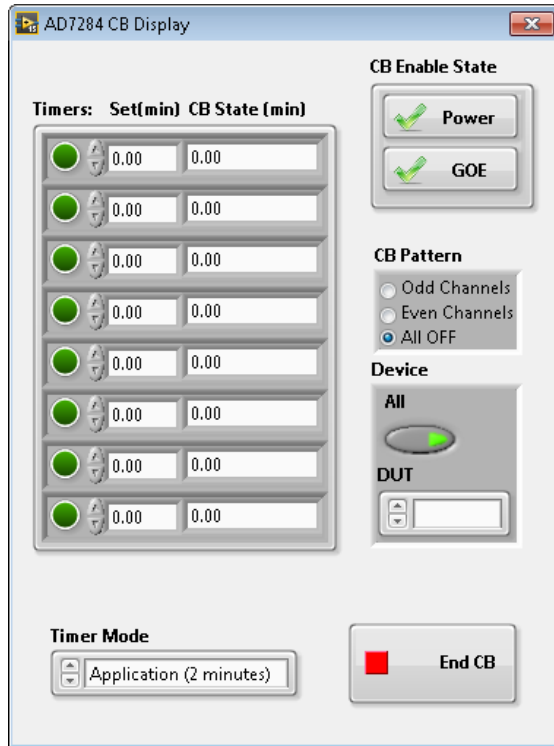

Figure 26. Cell Balance Control Pop-Up Window

The CB function is enabled by selecting the CB output (CB1 to CB8), time to balance, and the CB enable state.

To enable power to the CBx outputs, select **Power** and **GOE** (see to the **AD7284** data sheet for a more detailed explanation of the CBx function).

To select a CBx output,

1. Choose which device to control.
 - By default, **All** is selected, mirroring the configuration across all devices in the chain.
 - Deselecting **All** enables the **DUT** spin box and only the device that is selected is affected by further changes to the CB control.
2. To select individual CBx outputs,
 - a. Configure the time that the CBx output remains on using the **Configure Set Time** and **Elapsed Time** control for the appropriate CBx port. The **Timer Mode** spin box enables a demonstration mode to enable a fast counter to be enabled. This function is not supported for customer applications.
 - b. Enable the CBx port by selecting the appropriate green LED.
 - c. Use the **CB Pattern** options to quickly create a checker board pattern or to deselect all CBx ports.
3. To finish the CB operation, click **End CB** to disable the CBx outputs and turn off power to the CBx ports.

Exit

Click **Exit** to power down the chain and exit the software in a controlled manner.

Display Tabs

Chart Tab

The **Chart** tab displays the current conversion data. Controls are available to select the device under test (DUT) and data type to be displayed.

The **Display Control** area only affects the amount of data shown on the trace; it has no effect on the logging function. Right clicking on the chart displays functions to clear the chart or export data.

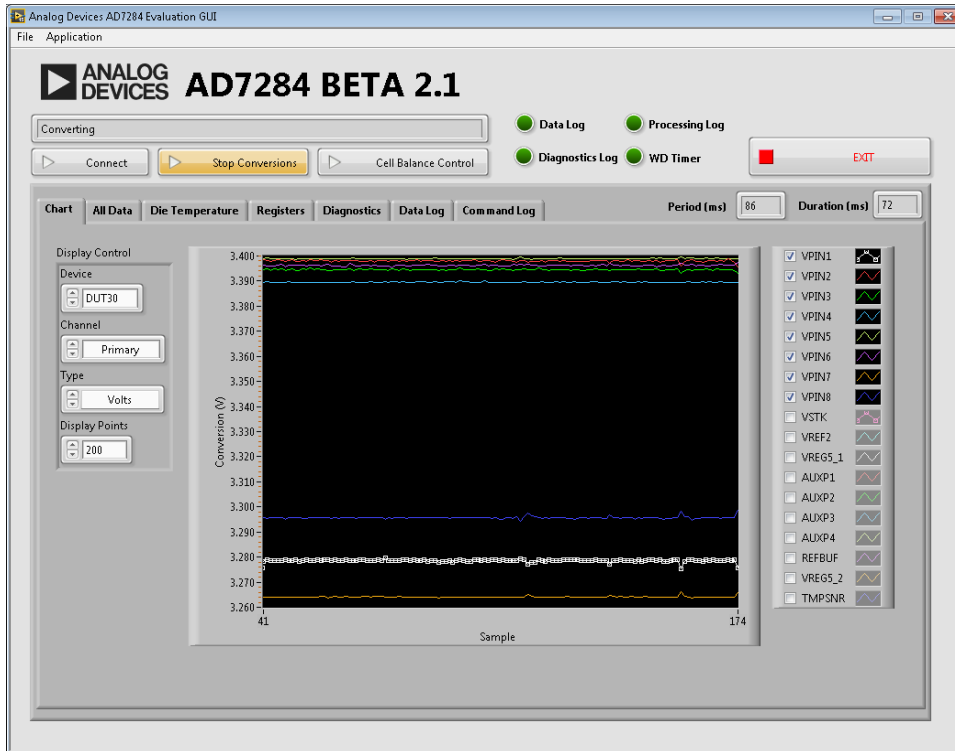

14713-027

Figure 27. Measurements Window Showing Current Conversion Results

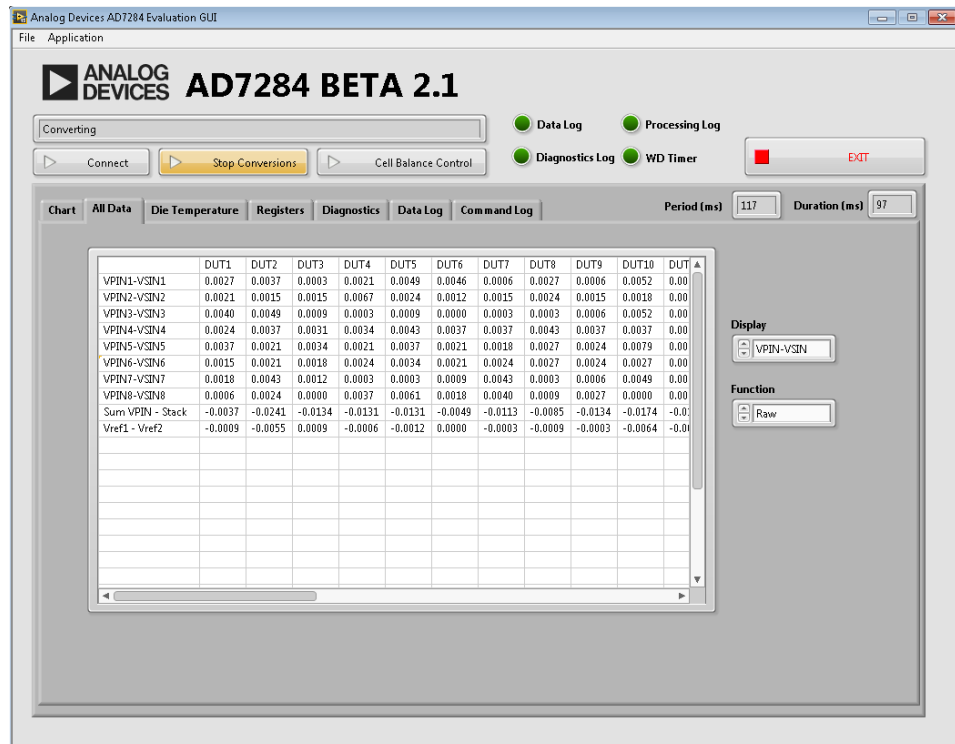

14713-028

Figure 28. All Data Tab Showing the Conversions Results

All Data Tab

The **All Data** tab, shown in Figure 28, displays data from all devices in the chain.

The **Display** spin box enables the user to view primary conversion data, secondary conversion data, or the difference between primary and secondary data (with the addition of a stack minus sum of V_{PINx} and $V_{REF1} - V_{REF2}$).

The **Function** spin box allows the user to view the raw data or a peak hold value (maximum absolute value measured).

Die Temperature Tab

The **Die Temperature** tab (see Figure 29) displays the current die temperature for each device in the stack. The die temperature is displayed in degrees Celsius. The voltage returned by the temperature sensor can also be seen on the **Chart** tab.

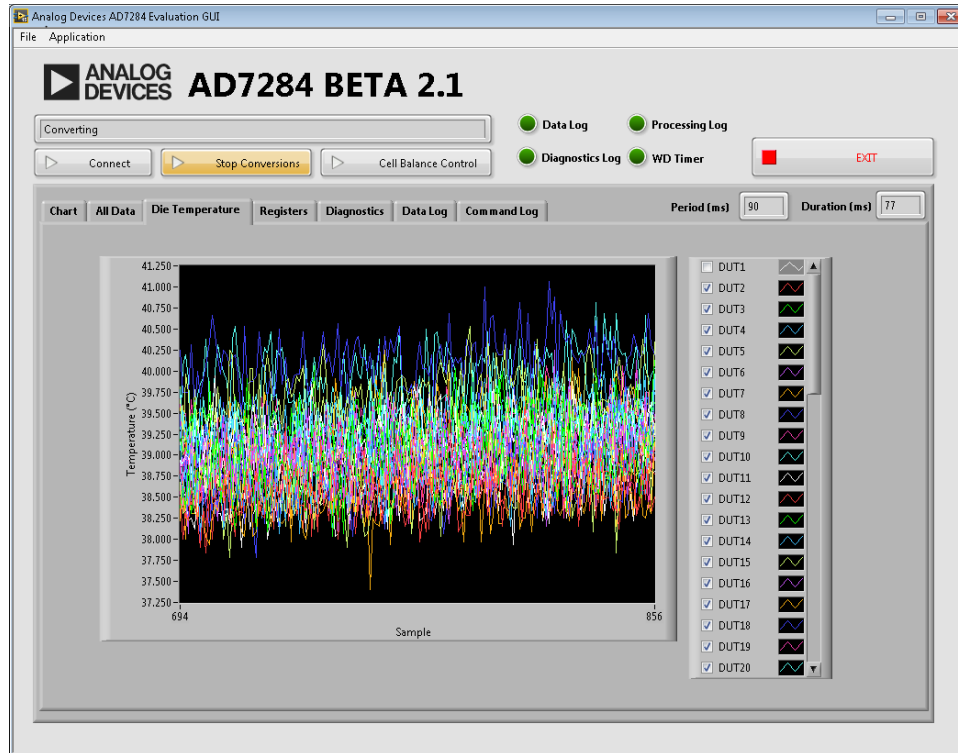

Figure 29. Die Temperature Display Showing the Current Die Temperature Measurement (in Degrees Celsius)

Registers Tab

The **Registers** tab gives access to the registers of each device in the chain.

The main table displays the contents of the registers after **Read All Registers** is selected; this function is only available when the device is not in a conversion cycle.

The **Save Register Data** control enables the user to save the contents of the register table to a .csv text file.

The **Write Register Control** area (see Figure 30) enables the user to write to a specific register in either all devices or a unique device in the chain.

Select **All Parts** to address all devices in the chain, With **All Parts** deselected, the **Device** selects a specific device.

The addressed register can be selected with the **Register** spin box. The **Value** spin box is the hexadecimal value written to a register.

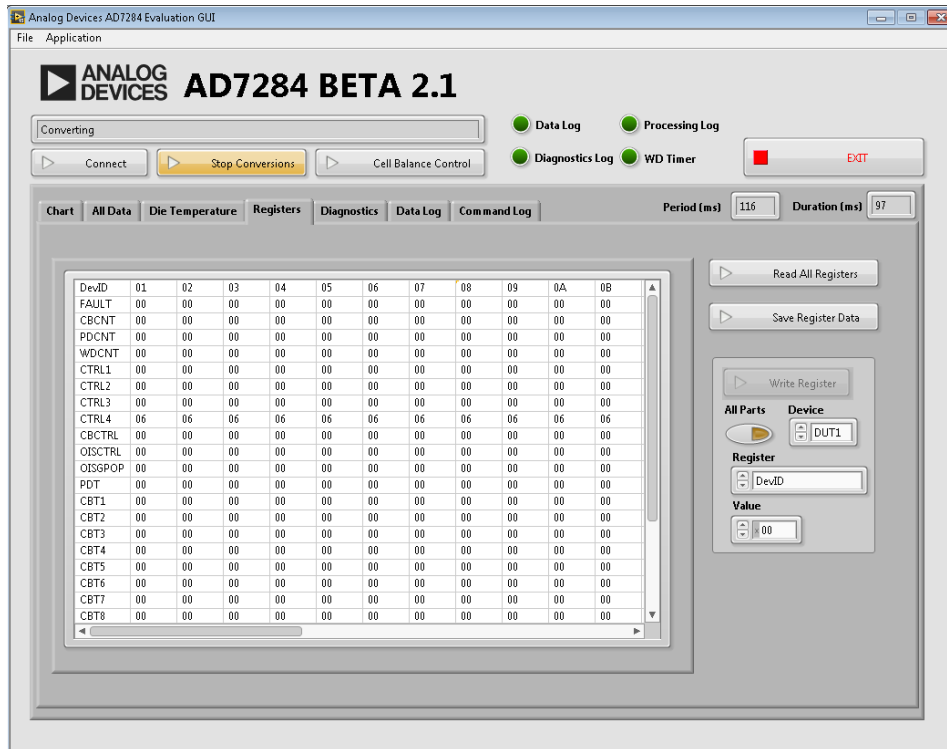

Figure 30. Registers Displaying the Current Value

Diagnostics Tab

The **Diagnostics** tab shows the calculation of diagnostics since the start of the conversion sequence. The levels to control the diagnostics are found under the **Internal Voltage Limits** option in the **Application** menu in the menu bar (see Figure 38).

Further details on the diagnostics can be found in the [AD7284 Safety Manual](#) and the [AD7284 data sheet](#).

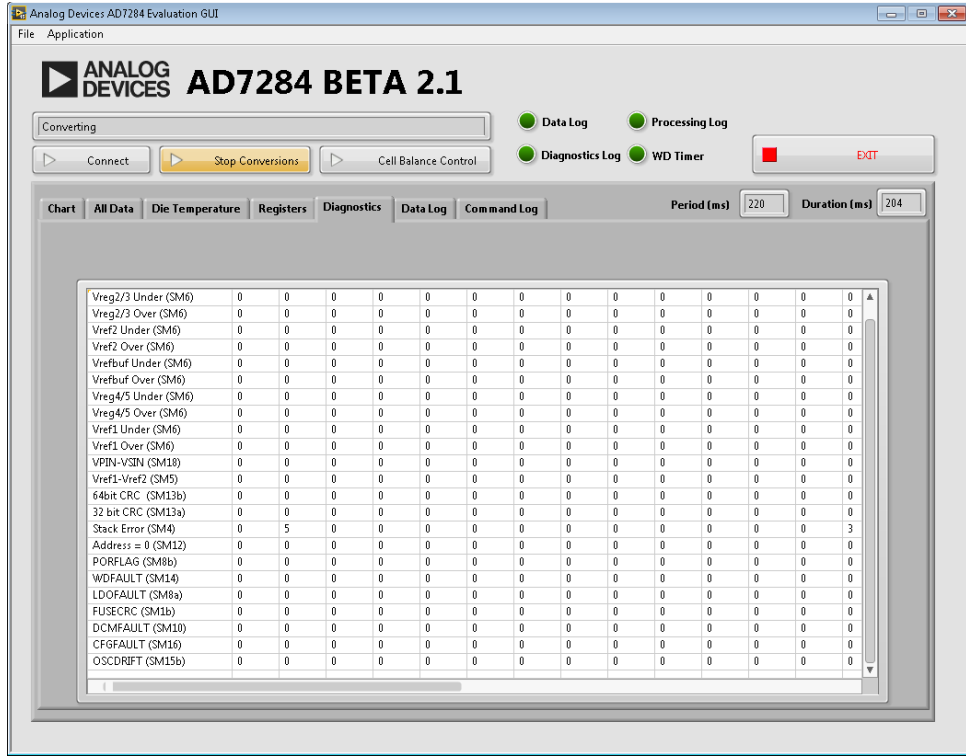

Figure 31. Diagnostics Window Showing the Accumulation of Events Since the Last Conversion Sequence

Data Log Tab

The GUI provides a basic interface to recall data saved using the logging function.

1. Select the data to display by clicking **Open Data File**.
2. After a file is selected, the **Time Interval** slider shows the extent of the data captured during a test. Use the sliders to select the portion of data to display, useful for larger files. The **Master** field and **Test Note** list box are also populated.

3. Select **Update Display** to update the graph with the selected data.
4. Right clicking on the graph opens additional graph functions. For example, right clicking the graph offers the option to clear the graph (**Clear Data**) or to send all the data to an Excel file (**Export to Excel**).

For larger technical data management solution (TDMS) files, a TDMS file viewer such as National Instruments DIAdem™ allows easy opening, navigation, and viewing (see Figure 33).

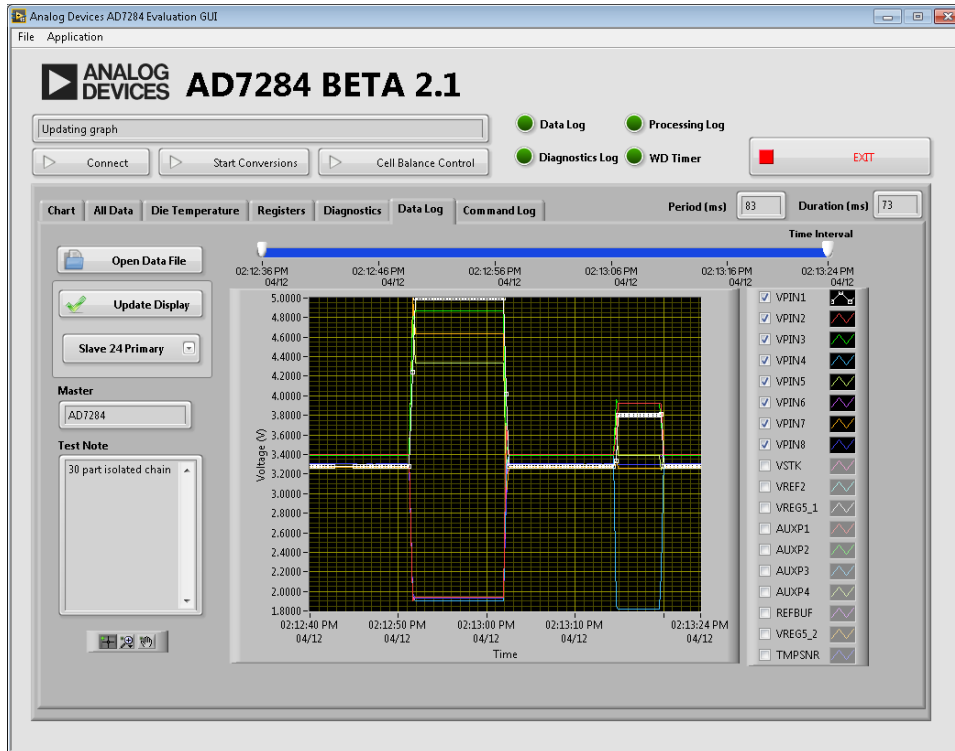

Figure 32. Recall Data

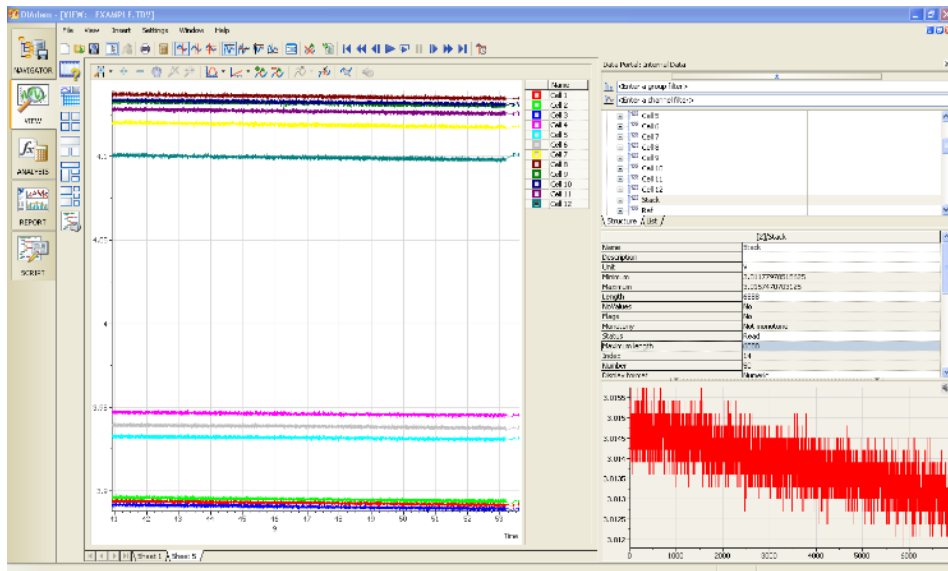

Figure 33. TDMS Data Viewed National Instruments DIAdem

Command Log Tab

The **Command Log** tab enables the user to capture snapshots of the register read and writes to the **AD7284** (see Figure 35). It is not recommended to enable this feature for long periods while continuously converting due to the volume of data that the code attempts to capture.

Save Log enables the user to export the contents of the display log to a text file.

File Dropdown Menu

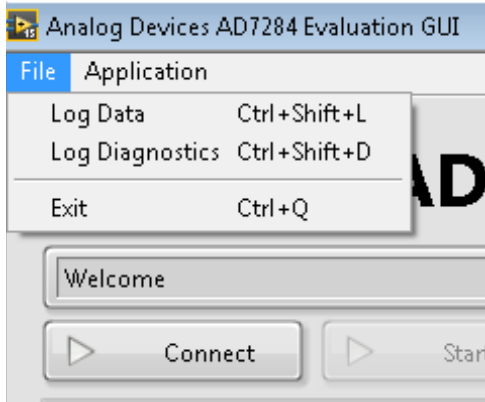

Figure 34. File Dropdown Menu

The **File** dropdown menu contains the function to save conversion data.

The **Exit** option closes the software immediately; it does not shut down the chain of devices prior to exit and must only be used as a last resort.

Log Data Command

The log data command enables the user to record all the conversions from a chain of **AD7284** devices in a chain (see Figure 36).

Start Logging Data

Select **File > Log Data** to start logging data.

Selecting the **Log Data** option opens a dialog box that prompts the user to select the root directory for the results file as well as the option to record a system identifier (**System ID**) and a note (**Log Note**).

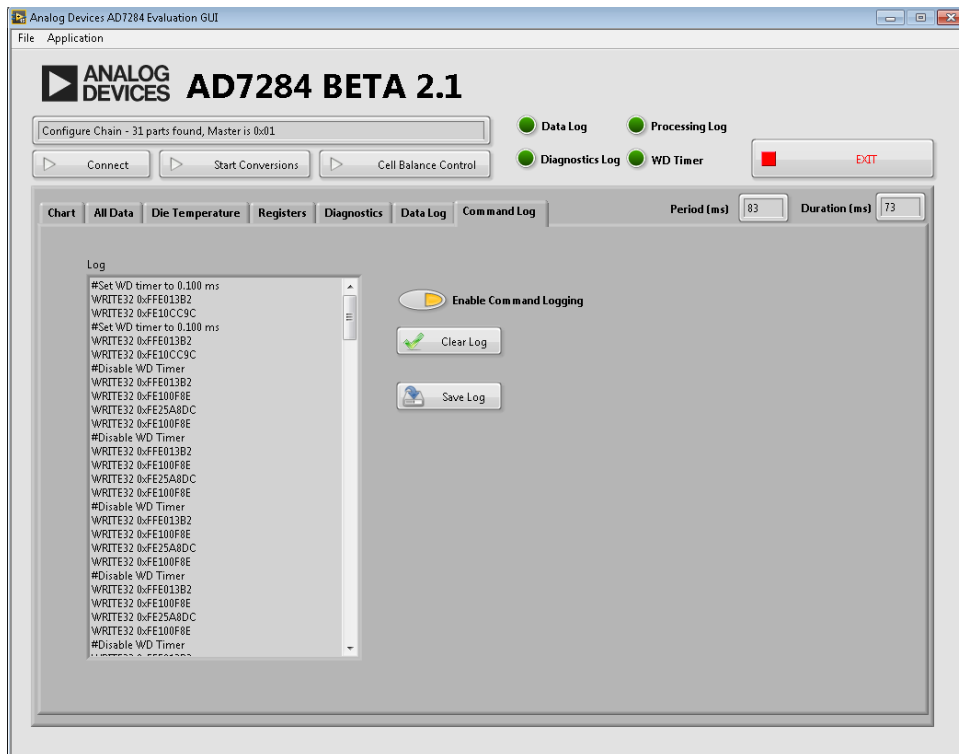

Figure 35. Command Log Tab

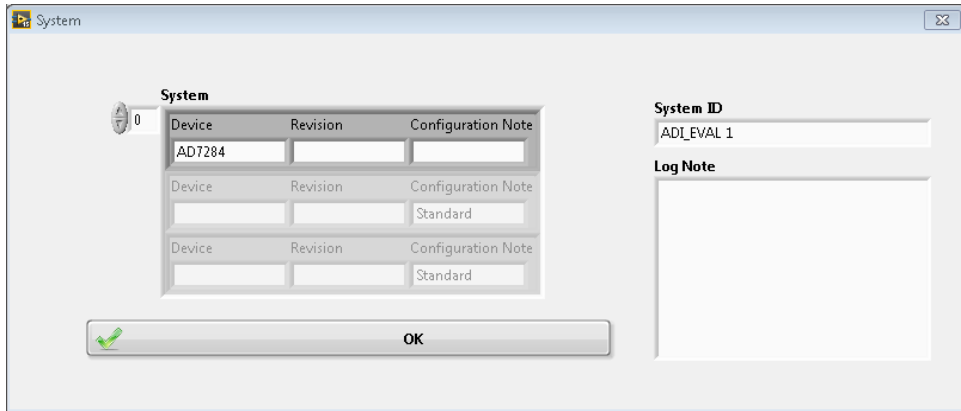

Figure 36. Log Data Command

After the dialog box closes, the **Data Log** indicator flashes green and orange and a tick appears next to the **Log Data** option.

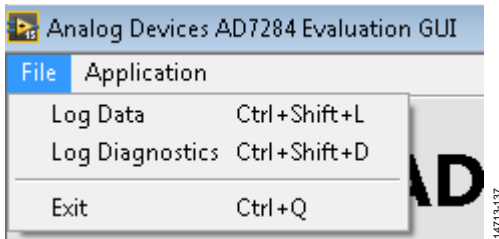

Figure 37. Log Data Started

Stop Logging

When data logging is in progress, select **File > Log Data** (removing the tick) to stop logging data.

The following events occur in order, without action by the user, when the logging is stopped:

1. The **Data Log** indicator stops flashing.
2. The **Processing Log** indicator starts to flash, indicating that a post processing step is initiated.
3. After post processing completes, the data file path is shown in the **Message** window.

Data is stored in TDMS form. Files in this format can be viewed using the following:

- The National Instruments TDM Excel Add-In
- The **Recall Data** window of the **AD7284** GUI
- DIAdem or other third party packages

Application Dropdown Menu

The **Application** menu contains the main functions used to control the conversion loop.

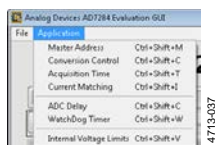

Figure 38. Application Dropdown Menu

Master Address

The **Master Address** window allows the user to enter the address of the master device in hexadecimal format. When selecting **OK**, the chain is reinitialized with the new master address.

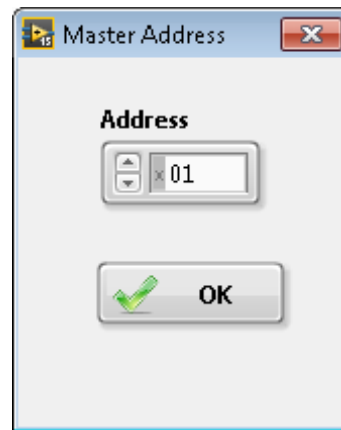

Figure 39. Master Address Control

Conversion Control

The **Conversion Control** window gives the user control over the acquisition cycle (see Figure 40).

With **Fixed Samples Count** disabled, the system operates in continuous conversion mode. When **Start Conversions** is selected, **Fixed Samples Count** being disabled is the default setting.

With **Fixed Samples Count** enabled, the system runs through the number of cycles specified using the **Number of Samples** spin box when **Start Conversions** is selected.

The target loop period, in milliseconds, is defined using the **Period (ms)** spin box.

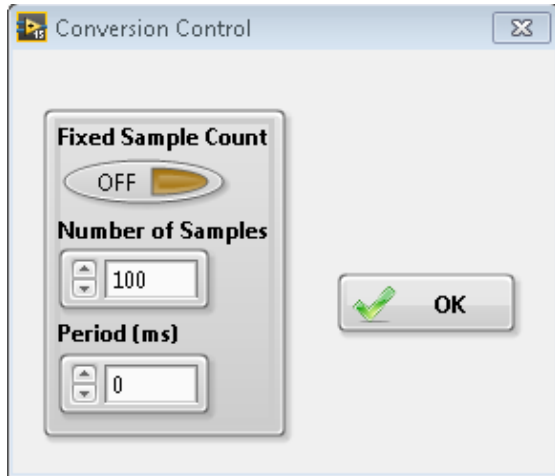

Figure 40. Conversion Control Pop-Up Window

Acquisition Times

The **Acquisition Times** window enables the ADC acquisition time to be controlled.

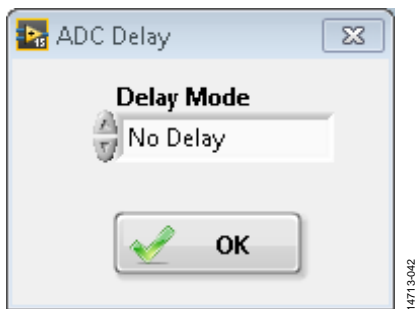

Figure 41. Acquisition Time Control

Current Matching

The **Current Matching** window allows the best device current matching options to be selected for each device in a chain. See the [AD7284](#) data sheet for further details on current matching.

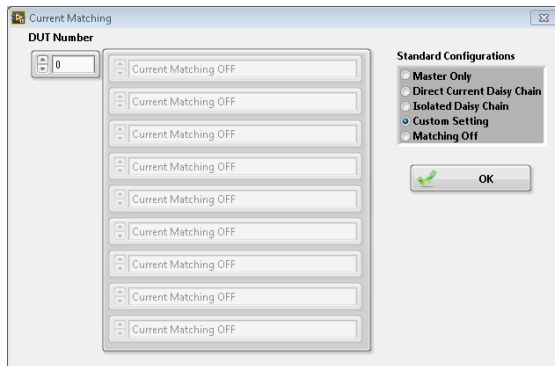

Figure 42. Current Matching Setup Window

ADC Delay

The **ADC Delay** window allows the user to select the ADC delay type used for the whole chain. The default value is **No Delay**; options are available to enable the delay mode between the primary and secondary conversions. See the [AD7284](#) data sheet for further details.

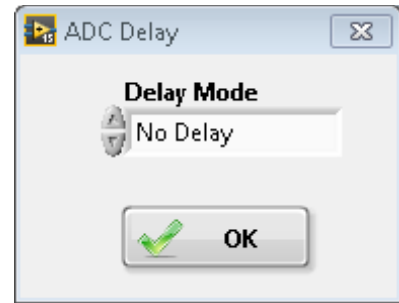

Figure 43. ADC Delay Mode Pop-Up Window

Watchdog Timer

The **WatchDog Timer** window enables the user to set the maximum time allowed to service the watchdog timer before the device powers down. See the [AD7284](#) data sheet for further details.

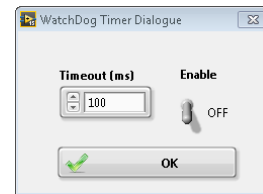

Figure 44. Watchdog Timer Control

When the **Enable** switch is toggled to **ON**, the **WD Timer** LED indicator on the main window is illuminated.

Internal Voltage Limits

The **Internal Voltage Limits** window sets the levels to control the diagnostics. See the Diagnostics Tab section and the [AD7284](#) data sheet for more details.



Figure 45. Internal Voltage Limits for Diagnostics Calculations

NOTES



ESD Caution

ESD (electrostatic discharge) sensitive device. Charged devices and circuit boards can discharge without detection. Although this product features patented or proprietary protection circuitry, damage may occur on devices subjected to high energy ESD. Therefore, proper ESD precautions should be taken to avoid performance degradation or loss of functionality.

Legal Terms and Conditions

By using the evaluation board discussed herein (together with any tools, components documentation or support materials, the "Evaluation Board"), you are agreeing to be bound by the terms and conditions set forth below ("Agreement") unless you have purchased the Evaluation Board, in which case the Analog Devices Standard Terms and Conditions of Sale shall govern. Do not use the Evaluation Board until you have read and agreed to the Agreement. Your use of the Evaluation Board shall signify your acceptance of the Agreement. This Agreement is made by and between you ("Customer") and Analog Devices, Inc. ("ADI"), with its principal place of business at One Technology Way, Norwood, MA 02062, USA. Subject to the terms and conditions of the Agreement, ADI hereby grants to Customer a free, limited, personal, temporary, non-exclusive, non-sublicensable, non-transferable license to use the Evaluation Board FOR EVALUATION PURPOSES ONLY. Customer understands and agrees that the Evaluation Board is provided for the sole and exclusive purpose referenced above, and agrees not to use the Evaluation Board for any other purpose. Furthermore, the license granted is expressly made subject to the following additional limitations: Customer shall not (i) rent, lease, display, sell, transfer, assign, sublicense, or distribute the Evaluation Board; and (ii) permit any Third Party to access the Evaluation Board. As used herein, the term "Third Party" includes any entity other than ADI, Customer, their employees, affiliates and in-house consultants. The Evaluation Board is NOT sold to Customer; all rights not expressly granted herein, including ownership of the Evaluation Board, are reserved by ADI. CONFIDENTIALITY. This Agreement and the Evaluation Board shall all be considered the confidential and proprietary information of ADI. Customer may not disclose or transfer any portion of the Evaluation Board to any other party for any reason. Upon discontinuation of use of the Evaluation Board or termination of this Agreement, Customer agrees to promptly return the Evaluation Board to ADI. ADDITIONAL RESTRICTIONS. Customer may not disassemble, decompile or reverse engineer chips on the Evaluation Board. Customer shall inform ADI of any occurred damages or any modifications or alterations it makes to the Evaluation Board, including but not limited to soldering or any other activity that affects the material content of the Evaluation Board. Modifications to the Evaluation Board must comply with applicable law, including but not limited to the RoHS Directive. TERMINATION. ADI may terminate this Agreement at any time upon giving written notice to Customer. Customer agrees to return to ADI the Evaluation Board at that time. LIMITATION OF LIABILITY. THE EVALUATION BOARD PROVIDED HEREUNDER IS PROVIDED "AS IS" AND ADI MAKES NO WARRANTIES OR REPRESENTATIONS OF ANY KIND WITH RESPECT TO IT. ADI SPECIFICALLY DISCLAIMS ANY REPRESENTATIONS, ENDORSEMENTS, GUARANTEES, OR WARRANTIES, EXPRESS OR IMPLIED, RELATED TO THE EVALUATION BOARD INCLUDING, BUT NOT LIMITED TO, THE IMPLIED WARRANTY OF MERCHANTABILITY, TITLE, FITNESS FOR A PARTICULAR PURPOSE OR NON-INFRINGEMENT OF INTELLECTUAL PROPERTY RIGHTS. IN NO EVENT WILL ADI AND ITS LICENSORS BE LIABLE FOR ANY INCIDENTAL, SPECIAL, INDIRECT, OR CONSEQUENTIAL DAMAGES RESULTING FROM CUSTOMER'S POSSESSION OR USE OF THE EVALUATION BOARD, INCLUDING BUT NOT LIMITED TO LOST PROFITS, DELAY COSTS, LABOR COSTS OR LOSS OF GOODWILL. ADI'S TOTAL LIABILITY FROM ANY AND ALL CAUSES SHALL BE LIMITED TO THE AMOUNT OF ONE HUNDRED US DOLLARS (\$100,000). EXPORT. Customer agrees that it will not directly or indirectly export the Evaluation Board to another country, and that it will comply with all applicable United States federal laws and regulations relating to exports. GOVERNING LAW. This Agreement shall be governed by and construed in accordance with the substantive laws of the Commonwealth of Massachusetts (excluding conflict of law rules). Any legal action regarding this Agreement will be heard in the state or federal courts having jurisdiction in Suffolk County, Massachusetts, and Customer hereby submits to the personal jurisdiction and venue of such courts. The United Nations Convention on Contracts for the International Sale of Goods shall not apply to this Agreement and is expressly disclaimed.

©2017 Analog Devices, Inc. All rights reserved. Trademarks and registered trademarks are the property of their respective owners.
UG14713-0-5/17(A)



www.analog.com