

PART NAME	NEMA 4X ENCLOSURE	PART No.	PN-1323, PN-1323-C AND PN-1323-DG	REV. DATE	11-17-08
-----------	-------------------	----------	-----------------------------------	-----------	----------

INDUSTRY STANDARDS:
POLYCARBONATE (LIGHT GRAY AND CLEAR)
 UL94-HB FLAMMABILITY RATING (UL FILE #E41613)
 UV STABILIZED
 SERVICE TEMPERATURE RANGE: -40°C TO +120°C

ABS (DARK GRAY)
 UL94-HB FLAMMABILITY RATING (UL FILE #E56070)
 SERVICE TEMPERATURE RANGE: -40°C TO +80°C

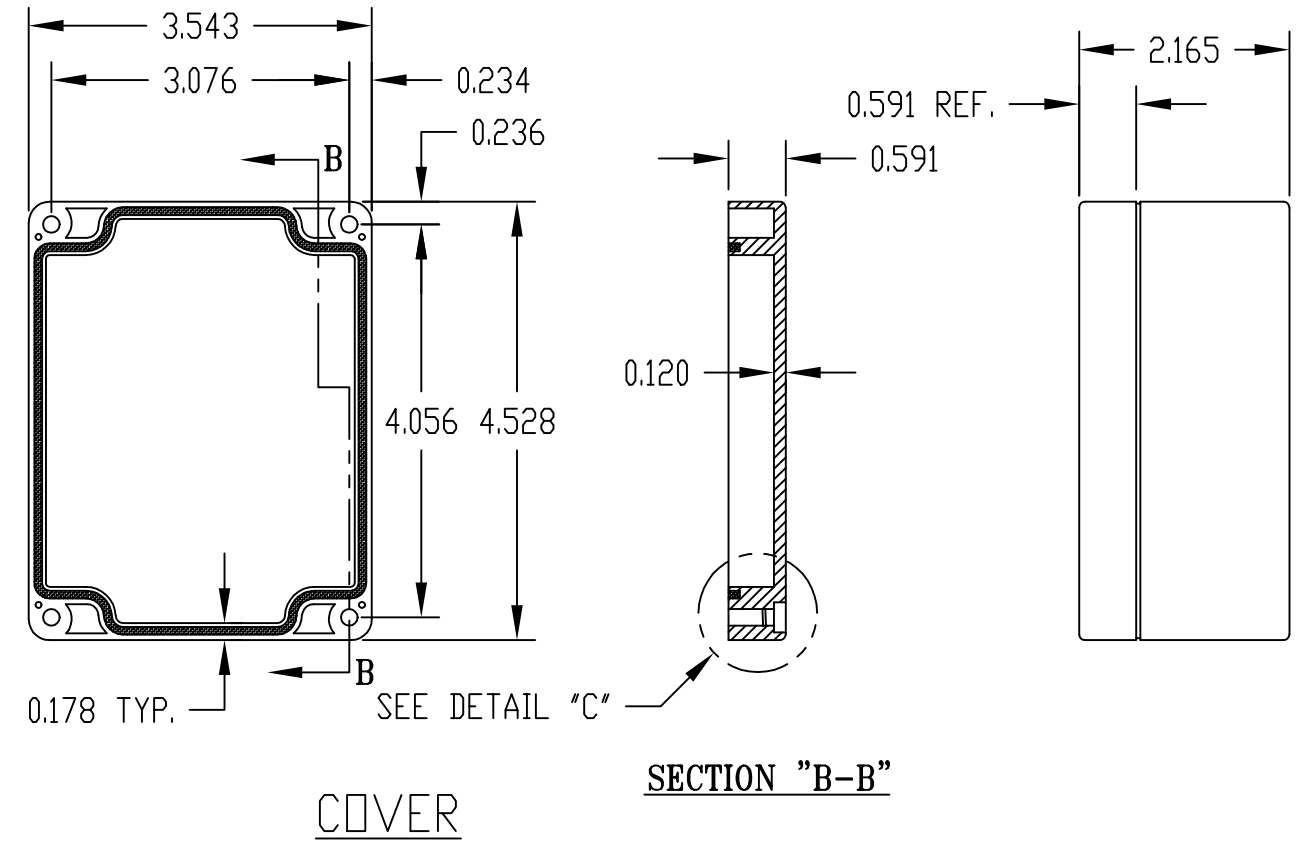
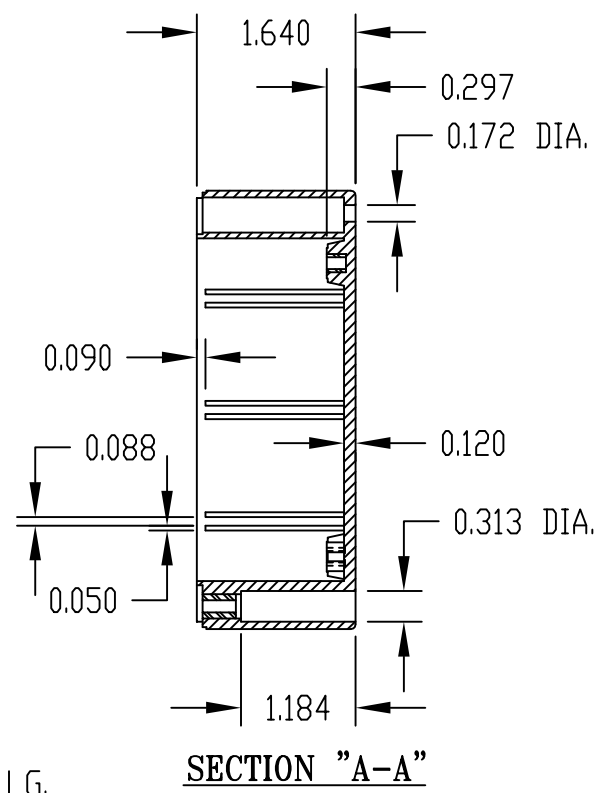
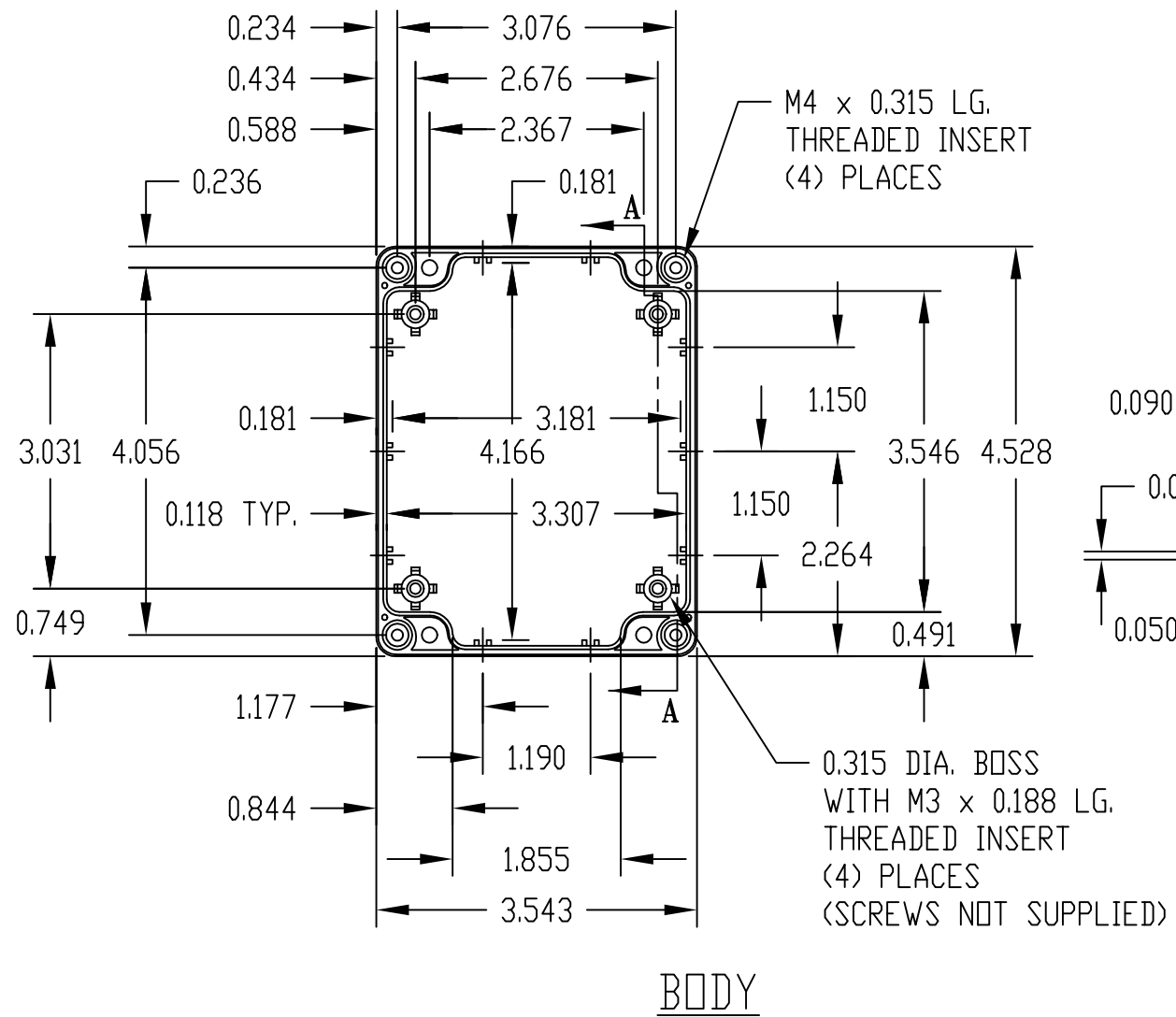

NOTE: ALL DIMENSIONS HAVE ±0.015 TOLERANCE UNLESS OTHERWISE SPECIFIED.

PART NUMBER	MATERIAL		FINISH		HARDWARE KIT
	BODY	COVER	BODY	COVER	
PN-1323	POLYCARBONATE		LIGHT GRAY		KIT CONTAINS (4) M4 x 20mm (0.787") LG. SCREWS FOR ASSEMBLY
PN-1323-C	POLYCARBONATE		LIGHT GRAY	CLEAR	
PN-1323-DG	HIGH-IMPACT ABS		DARK GRAY		