

FEATURES

4 A peak output current

Working voltage

High-side or low-side relative to input: 537 V peak

High-side to low-side differential: 800 V peak

High frequency operation: 1 MHz maximum

3.3 V to 5 V CMOS input logic

4.5 V to 18 V output drive

UVLO at 2.5 V V_{DD1}

ADuM3223A/ADuM4223A UVLO at 4.1 V V_{DD2}

ADuM3223B/ADuM4223B UVLO at 7.0 V V_{DD2}

ADuM3223C/ADuM4223C UVLO at 11.0 V V_{DD2}

Precise timing characteristics

54 ns maximum isolator and driver propagation delay

5 ns maximum channel-to-channel matching

CMOS input logic levels

High common-mode transient immunity: >25 kV/ μ s

Enhanced system-level ESD performance per IEC 61000-4-x

High junction temperature operation: 125°C

Thermal shutdown protection

Default low output

Safety and regulatory approvals

ADuM3223 narrow-body, 16-lead SOIC

UL recognition per UL 1577

3000 V rms for 1 minute SOIC long package

CSA Component Acceptance Notice 5A

VDE certificate of conformity

DIN V VDE V 0884-10 (VDE V 0884-10):2006-12

V_{IORM} = 560 V peak

ADuM4223 wide-body, 16-lead SOIC

UL recognition per UL 1577

5000 V rms for 1 minute SOIC long package

CSA Component Acceptance Notice 5A

VDE certificate of conformity

DIN V VDE V 0884-10 (VDE V 0884-10):2006-12

V_{IORM} = 849 V peak

Qualified for automotive applications

APPLICATIONS

Switching power supplies

Isolated IGBT/MOSFET gate drives

Industrial inverters

Automotive

FUNCTIONAL BLOCK DIAGRAM

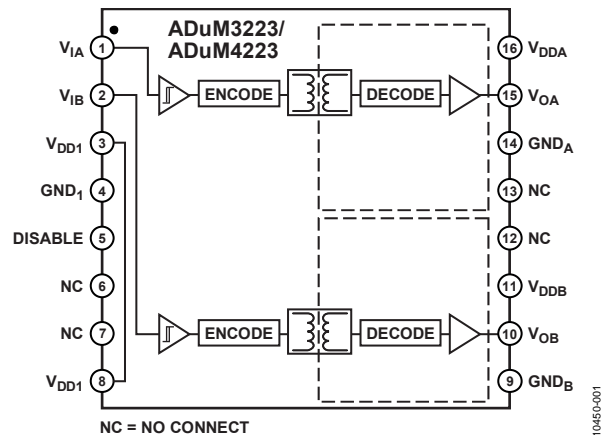

Figure 1.

GENERAL DESCRIPTION

The ADuM3223/ADuM4223¹ are 4 A isolated, half-bridge gate drivers that employ the Analog Devices, Inc., iCoupler® technology to provide independent and isolated high-side and low-side outputs. The ADuM3223 provides 3000 V rms isolation in the narrow body, 16-lead SOIC package, and the ADuM4223 provides 5000 V rms isolation in the wide body, 16-lead SOIC package. Combining high speed CMOS and monolithic transformer technology, these isolation components provide outstanding performance characteristics superior to the alternatives, such as the combination of pulse transformers and gate drivers.

The ADuM3223/ADuM4223 isolators each provide two independent isolated channels. They operate with an input supply ranging from 3.0 V to 5.5 V, providing compatibility with lower voltage systems. In comparison to gate drivers employing high voltage level translation methodologies, the ADuM3223/ADuM4223 offer the benefit of true, galvanic isolation between the input and each output. Each output may be continuously operated up to 537 V peak relative to the input, thereby supporting low-side switching to negative voltages. The differential voltage between the high-side and low-side may be as high as 800 V peak.

As a result, the ADuM3223/ADuM4223 provide reliable control over the switching characteristics of IGBT/MOSFET configurations over a wide range of positive or negative switching voltages.

¹ Protected by U.S. Patents 5,952,849; 6,873,065; 7,075,239. Other patents pending.

Rev. I

[Document Feedback](#)

Information furnished by Analog Devices is believed to be accurate and reliable. However, no responsibility is assumed by Analog Devices for its use, nor for any infringements of patents or other rights of third parties that may result from its use. Specifications subject to change without notice. No license is granted by implication or otherwise under any patent or patent rights of Analog Devices. Trademarks and registered trademarks are the property of their respective owners.

TABLE OF CONTENTS

| | |
|---|---|
| Features | 1 |
| Applications | 1 |
| Functional Block Diagram | 1 |
| General Description | 1 |
| Revision History | 2 |
| Specifications | 3 |
| Electrical Characteristics—5 V Operation | 3 |
| Electrical Characteristics—3.3 V Operation | 4 |
| Package Characteristics | 5 |
| Insulation and Safety-Related Specifications | 5 |
| Regulatory Information | 6 |
| DIN V VDE V 0884-10 (VDE V 0884-10) Insulation Characteristics | 7 |
| Recommended Operating Conditions | 8 |
| Absolute Maximum Ratings | 9 |

REVISION HISTORY

3/2017—Rev. H to Rev. I

| | |
|---------------------------|----|
| Changes to Table 14 | 11 |
|---------------------------|----|

1/2017—Rev. G to Rev. H

| | |
|---------------------------|----|
| Changes to Table 13 | 10 |
|---------------------------|----|

11/2015—Rev. F to Rev. G

| | |
|--|----|
| Changes to Power Consumption Section | 17 |
|--|----|

7/2015—Rev. E to Rev. F

| | |
|--|----|
| Changes to Features Section | 1 |
| Changes to Table 6 and Table 7 | 6 |
| Changes to Power Consumption Section | 17 |

11/2014—Rev. D to Rev. E

| | |
|--|---|
| Changes to Features Section and General Description Section | 1 |
| Changes to Table 5 | 5 |
| Changes to Regulatory Information Section, Table 6, and Table 7 | 6 |
| Changes to Table 8 and Table 9 | 7 |

4/2014—Rev. C to Rev. D

| | |
|--|----|
| Changes to Applications Section | 1 |
| Changes to Insulation Lifetime Section | 18 |
| Changes to Ordering Guide | 20 |

12/2013—Rev. B to Rev. C

| | |
|----------------------------------|---|
| Change to Features Section | 1 |
|----------------------------------|---|

| | |
|---|----|
| ESD Caution | 9 |
| Pin Configuration and Function Descriptions | 11 |
| Typical Performance Characteristics | 12 |
| Applications Information | 15 |
| PC Board Layout | 15 |
| Propagation Delay-Related Parameters | 15 |
| Thermal Limitations and Switch Load Characteristics | 15 |
| Output Load Characteristics | 15 |
| Boot-Strapped Half-Bridge Operation | 16 |
| DC Correctness and Magnetic Field Immunity | 16 |
| Power Consumption | 17 |
| Insulation Lifetime | 18 |
| Outline Dimensions | 19 |
| Ordering Guide | 20 |
| Automotive Products | 20 |

| | |
|---|----|
| Changes to Switching Specifications Parameter, Table 1 | 3 |
| Added Thermal Shutdown Temperatures Parameter, Table 1 | 3 |
| Changes to Switching Specifications Parameter, Table 2 | 4 |
| Added Thermal Shutdown Temperatures Parameter, Table 2 | 4 |
| Changes to Table 10 | 8 |
| Change to Figure 13 Caption | 13 |
| Changes to Thermal Limitations and Switch Load Characteristics Section | 15 |
| Change to Boot-Strapped Half-Bridge Operation Section | 16 |

5/2013—Rev. A to Rev. B

| | |
|---|----|
| Added V_{DDA} , V_{DDB} Rise Time of 0.5 V/ μ s; Table 10 | 8 |
| Changes to Figure 22 | 16 |

1/2013—Rev. 0 to Rev. A

| | |
|---|----|
| Added Automotive Information (Throughout) | 1 |
| Updated Safety and Regulatory Approvals (Throughout) | 1 |
| Changed High-Side to Low-Side Differential from 700 V _{DC PEAK} to 800 V peak | 1 |
| Added R_{OA} , R_{OB} Minimum and Maximum Values, Table 1 | 3 |
| Added R_{OA} , R_{OB} Minimum and Maximum Values, Table 2 | 4 |
| Changes to Table 13 | 10 |
| Changes to Figure 19 | 15 |
| Added Boot-Strapped Half Bridge Operation Section and Figure 22; Renumbered Sequentially | 16 |
| Changes to Ordering Guide | 20 |

5/2012—Revision 0: Initial Version

SPECIFICATIONS

ELECTRICAL CHARACTERISTICS—5 V OPERATION

All voltages are relative to their respective ground. $4.5\text{ V} \leq V_{DD1} \leq 5.5\text{ V}$, $4.5\text{ V} \leq V_{DD2} \leq 18\text{ V}$, unless stated otherwise. All minimum/maximum specifications apply over $T_j = -40^\circ\text{C}$ to 125°C . All typical specifications are at $T_j = 25^\circ\text{C}$, $V_{DD1} = 5\text{ V}$, $V_{DD2} = 12\text{ V}$. Switching specifications are tested with CMOS signal levels.

Table 1.

| Parameter | Symbol | Min | Typ | Max | Unit | Test Conditions |
|--|--------------------------|----------------------|-----------|----------------------|------------------|--|
| DC SPECIFICATIONS | | | | | | |
| Input Supply Current, Quiescent | $I_{DDI(Q)}$ | | 1.4 | 2.4 | mA | |
| Output Supply Current, Per Channel, Quiescent | $I_{DDO(Q)}$ | | 2.3 | 3.2 | mA | |
| Supply Current at 1 MHz | | | | | | |
| V_{DD1} Supply Current | $I_{DD1(Q)}$ | | 1.6 | 2.5 | mA | Up to 1 MHz, no load |
| V_{DDA}/V_{DDB} Supply Current | $I_{DDA}/I_{DDB(Q)}$ | | 5.6 | 8.0 | mA | Up to 1 MHz, no load |
| Input Currents | I_{IA}, I_{IB} | -1 | +0.01 | +1 | μA | $0 \leq V_{IA}, V_{IB} \leq V_{DD1}$ |
| Logic High Input Threshold | V_{IH} | $0.7 \times V_{DD1}$ | | | V | |
| Logic Low Input Threshold | V_{IL} | | | $0.3 \times V_{DD1}$ | V | |
| Logic High Output Voltages | V_{OAH}, V_{OBH} | $V_{DD2} - 0.1$ | V_{DD2} | | V | $I_{Ox} = -20\text{ mA}$, $V_{Ix} = V_{IxH}$ |
| Logic Low Output Voltages | V_{OAL}, V_{OBL} | | 0.0 | 0.15 | V | $I_{Ox} = +20\text{ mA}$, $V_{Ix} = V_{IxL}$ |
| Undervoltage Lockout, V_{DD2} Supply | | | | | | |
| Positive Going Threshold | V_{DD2UV+} | | 4.1 | 4.4 | V | A-grade |
| Negative Going Threshold | V_{DD2UV-} | 3.2 | 3.6 | | V | A-grade |
| Hysteresis | V_{DD2UVH} | | 0.5 | | V | A-grade |
| Positive Going Threshold | V_{DD2UV+} | | 6.9 | 7.4 | V | B-grade |
| Negative Going Threshold | V_{DD2UV-} | 5.7 | 6.2 | | V | B-grade |
| Hysteresis | V_{DD2UVH} | | 0.7 | | V | B-grade |
| Positive Going Threshold | V_{DD2UV+} | | 10.5 | 11.1 | V | C-grade |
| Negative Going Threshold | V_{DD2UV-} | 8.9 | 9.6 | | V | C-grade |
| Hysteresis | V_{DD2UVH} | | 0.9 | | V | C-grade |
| Output Short-Circuit Pulsed Current ¹ | $I_{OAS(C)}, I_{OBS(C)}$ | 2.0 | 4.0 | | A | $V_{DD2} = 12\text{ V}$ |
| Output Pulsed Source Resistance | R_{OA}, R_{OB} | 0.3 | 1.1 | 3.0 | Ω | $V_{DD2} = 12\text{ V}$ |
| Output Pulsed Sink Resistance | R_{OA}, R_{OB} | 0.3 | 0.6 | 3.0 | Ω | $V_{DD2} = 12\text{ V}$ |
| THERMAL SHUTDOWN TEMPERATURES | | | | | | |
| Junction Temperature Shutdown, Rising Edge | T_{JR} | | 150 | | $^\circ\text{C}$ | |
| Junction Temperature Shutdown, Falling Edge | T_{JF} | | 140 | | $^\circ\text{C}$ | |
| SWITCHING SPECIFICATIONS | | | | | | |
| Pulse Width ² | PW | 50 | | | ns | $C_L = 2\text{ nF}$, $V_{DD2} = 12\text{ V}$ |
| Maximum Data Rate ³ | | 1 | | | MHz | $C_L = 2\text{ nF}$, $V_{DD2} = 12\text{ V}$ |
| Propagation Delay ⁴ | t_{DHL}, t_{DLH} | 31 | 43 | 54 | ns | $C_L = 2\text{ nF}$, $V_{DD2} = 12\text{ V}$; see Figure 20 |
| ADuM3223A/ADuM4223A | t_{DHL}, t_{DLH} | 35 | 47 | 59 | ns | $C_L = 2\text{ nF}$, $V_{DD2} = 4.5\text{ V}$; see Figure 20 |
| Propagation Delay Skew ⁵ | t_{PSK} | | | 12 | ns | $C_L = 2\text{ nF}$, $V_{DD2} = 12\text{ V}$; see Figure 20 |
| Channel-to-Channel Matching ⁶ | t_{PSKCD} | | 1 | 5 | ns | $C_L = 2\text{ nF}$, $V_{DD2} = 12\text{ V}$; see Figure 20 |
| | t_{PSKCD} | | 1 | 7 | ns | $C_L = 2\text{ nF}$, $V_{DD2} = 4.5\text{ V}$; see Figure 20 |
| Output Rise/Fall Time (10% to 90%) | t_R/t_F | 6 | 12 | 18 | ns | $C_L = 2\text{ nF}$, $V_{DD2} = 12\text{ V}$; see Figure 20 |
| Dynamic Input Supply Current Per Channel | $I_{DDI(D)}$ | | 0.05 | | mA/Mbps | $V_{DD2} = 12\text{ V}$ |
| Dynamic Output Supply Current Per Channel | $I_{DDO(D)}$ | | 1.65 | | mA/Mbps | $V_{DD2} = 12\text{ V}$ |
| Refresh Rate | f_r | | 1.2 | | Mbps | |

¹ Short-circuit duration less than 1 μs . Average power must conform to the limit shown under the Absolute Maximum Ratings.

² The minimum pulse width is the shortest pulse width at which the specified timing parameter is guaranteed.

³ The maximum data rate is the fastest data rate at which the specified timing parameter is guaranteed.

⁴ t_{DLH} propagation delay is measured from the time of the input rising logic high threshold, V_{IH} , to the output rising 10% level of the V_{Ox} signal. t_{DHL} propagation delay is measured from the input falling logic low threshold, V_{IL} , to the output falling 90% threshold of the V_{Ox} signal. See Figure 20 for waveforms of propagation delay parameters.

⁵ t_{PSK} is the magnitude of the worst-case difference in t_{DLH} and/or t_{DHL} that is measured between units at the same operating temperature, supply voltages, and output load within the recommended operating conditions. See Figure 20 for waveforms of propagation delay parameters.

⁶ Channel-to-channel matching is the absolute value of the difference in propagation delays between the two channels.

ELECTRICAL CHARACTERISTICS—3.3 V OPERATION

All voltages are relative to their respective ground. $3.0\text{ V} \leq V_{DD1} \leq 3.6\text{ V}$, $4.5\text{ V} \leq V_{DD2} \leq 18\text{ V}$, unless stated otherwise. All minimum/maximum specifications apply over $T_J = -40^\circ\text{C}$ to 125°C . All typical specifications are at $T_J = 25^\circ\text{C}$, $V_{DD1} = 3.3\text{ V}$, $V_{DD2} = 12\text{ V}$. Switching specifications are tested with CMOS signal levels.

Table 2.

| Parameter | Symbol | Min | Typ | Max | Unit | Test Conditions |
|--|--------------------------|----------------------|-----------|----------------------|------------------|---|
| DC SPECIFICATIONS | | | | | | |
| Input Supply Current, Quiescent | $I_{DD(Q)}$ | | 0.87 | 1.4 | mA | |
| Output Supply Current, Per Channel, Quiescent | $I_{DDO(Q)}$ | | 2.3 | 3.2 | mA | |
| Supply Current at 1 MHz | | | | | | |
| V_{DD1} Supply Current | $I_{DD1(Q)}$ | | 1.1 | 1.5 | mA | Up to 1 MHz, no load |
| V_{DDA}/V_{DDB} Supply Current | $I_{DDA}/I_{DDB(Q)}$ | | 5.6 | 8.0 | mA | Up to 1 MHz, no load |
| Input Currents | I_{IA}, I_{IB} | -10 | +0.01 | +10 | μA | $0 \leq V_{IA}, V_{IB} \leq V_{DD1}$ |
| Logic High Input Threshold | V_{IH} | $0.7 \times V_{DD1}$ | | | V | |
| Logic Low Input Threshold | V_{IL} | | | $0.3 \times V_{DD1}$ | V | |
| Logic High Output Voltages | V_{OAH}, V_{OBH} | $V_{DD2} - 0.1$ | V_{DD2} | | V | $I_{Ox} = -20\text{ mA}, V_{Ix} = V_{IxH}$ |
| Logic Low Output Voltages | V_{OAL}, V_{OBL} | | 0.0 | 0.15 | V | $I_{Ox} = +20\text{ mA}, V_{Ix} = V_{IxL}$ |
| Undervoltage Lockout, V_{DD2} Supply | | | | | | |
| Positive Going Threshold | V_{DD2UV+} | | 4.1 | 4.4 | V | A-grade |
| Negative Going Threshold | V_{DD2UV-} | 3.2 | 3.6 | | V | A-grade |
| Hysteresis | V_{DD2UVH} | | 0.5 | | V | A-grade |
| Positive Going Threshold | V_{DD2UV+} | | 6.9 | 7.4 | V | B-grade |
| Negative Going Threshold | V_{DD2UV-} | 5.7 | 6.2 | | V | B-grade |
| Hysteresis | V_{DD2UVH} | | 0.7 | | V | B-grade |
| Positive Going Threshold | V_{DD2UV+} | | 10.5 | 11.1 | V | C-grade |
| Negative Going Threshold | V_{DD2UV-} | 8.9 | 9.6 | | V | C-grade |
| Hysteresis | V_{DD2UVH} | | 0.9 | | V | C-grade |
| Output Short-Circuit Pulsed Current ¹ | $I_{OA(SC)}, I_{OB(SC)}$ | 2.0 | 4.0 | | A | $V_{DD2} = 12\text{ V}$ |
| Output Pulsed Source Resistance | R_{OA}, R_{OB} | 0.3 | 1.1 | 3.0 | Ω | $V_{DD2} = 12\text{ V}$ |
| Output Pulsed Sink Resistance | R_{OA}, R_{OB} | 0.3 | 0.6 | 3.0 | Ω | $V_{DD2} = 12\text{ V}$ |
| THERMAL SHUTDOWN TEMPERATURE | | | | | | |
| Junction Temperature Shutdown, Rising Edge | T_{JR} | | 150 | | $^\circ\text{C}$ | |
| Junction Temperature Shutdown, Falling Edge | T_{JF} | | 140 | | $^\circ\text{C}$ | |
| SWITCHING SPECIFICATIONS | | | | | | |
| Pulse Width ² | PW | 50 | | | ns | $C_L = 2\text{ nF}, V_{DD2} = 12\text{ V}$ |
| Maximum Data Rate ³ | | 1 | | | MHz | $C_L = 2\text{ nF}, V_{DD2} = 12\text{ V}$ |
| Propagation Delay ⁴ | t_{DHL}, t_{DLH} | 35 | 47 | 59 | ns | $C_L = 2\text{ nF}, V_{DD2} = 12\text{ V}$, see Figure 20 |
| ADuM3223A/ADuM4223A | t_{DHL}, t_{DLH} | 37 | 51 | 65 | ns | $C_L = 2\text{ nF}, V_{DD2} = 4.5\text{ V}$, see Figure 20 |
| Propagation Delay Skew ⁵ | t_{PSK} | | | 12 | ns | $C_L = 2\text{ nF}, V_{DD2} = 12\text{ V}$, see Figure 20 |
| Channel-to-Channel Matching ⁶ | t_{PSKCD} | | 1 | 5 | ns | $C_L = 2\text{ nF}, V_{DD2} = 12\text{ V}$, see Figure 20 |
| | t_{PSKCD} | | 1 | 7 | ns | $C_L = 2\text{ nF}, V_{DD2} = 4.5\text{ V}$, see Figure 20 |
| Output Rise/Fall Time (10% to 90%) | t_R/t_F | 6 | 12 | 22 | ns | $C_L = 2\text{ nF}, V_{DD2} = 12\text{ V}$, see Figure 20 |
| Dynamic Input Supply Current Per Channel | $I_{DD(D)}$ | | 0.05 | | mA/Mbps | $V_{DD2} = 12\text{ V}$ |
| Dynamic Output Supply Current Per Channel | $I_{DDO(D)}$ | | 1.65 | | mA/Mbps | $V_{DD2} = 12\text{ V}$ |
| Refresh Rate | f_r | | 1.1 | | Mbps | |

¹ Short-circuit duration less than 1 μs . Average power must conform to the limit shown under the Absolute Maximum Ratings.

² The minimum pulse width is the shortest pulse width at which the specified timing parameter is guaranteed.

³ The maximum data rate is the fastest data rate at which the specified timing parameter is guaranteed.

⁴ t_{DLH} propagation delay is measured from the time of the input rising logic high threshold, V_{IH} , to the output rising 10% level of the V_{Ox} signal. t_{DHL} propagation delay is measured from the input falling logic low threshold, V_{IL} , to the output falling 90% threshold of the V_{Ox} signal. See Figure 20 for waveforms of propagation delay parameters.

⁵ t_{PSK} is the magnitude of the worst-case difference in t_{DLH} and/or t_{DHL} that is measured between units at the same operating temperature, supply voltages, and output load within the recommended operating conditions. See Figure 20 for waveforms of propagation delay parameters.

⁶ Channel-to-channel matching is the absolute value of the difference in propagation delays between the two channels.

PACKAGE CHARACTERISTICS

Table 3.

| Parameter | Symbol | Min | Typ | Max | Unit | Test Conditions |
|---|---------------|-----|------------------|-----|-----------------------------|-----------------|
| Resistance (Input-to-Output) | R_{I-O} | | 10 ¹² | | Ω | f = 1 MHz |
| Capacitance (Input-to-Output) | C_{I-O} | | 2.0 | | pF | |
| Input Capacitance | C_I | | 4.0 | | pF | |
| IC Junction-to-Ambient Thermal Resistance | | | | | | |
| ADuM3223 | θ_{JA} | | 76 | | $^{\circ}\text{C}/\text{W}$ | |
| ADuM4223 | θ_{JA} | | 45 | | $^{\circ}\text{C}/\text{W}$ | |
| IC Junction-to-Case Thermal Resistance | | | | | | |
| ADuM3223 | θ_{JC} | | 42 | | $^{\circ}\text{C}/\text{W}$ | |
| ADuM4223 | θ_{JC} | | 29 | | $^{\circ}\text{C}/\text{W}$ | |

INSULATION AND SAFETY-RELATED SPECIFICATIONS

ADuM3223

Table 4.

| Parameter | Symbol | Value | Unit | Conditions |
|--|--------|-----------|-------|--|
| Rated Dielectric Insulation Voltage | | 3000 | V rms | 1 minute duration |
| Minimum External Air Gap (Clearance) | L(I01) | 4.0 min | mm | Measured from input terminals to output terminals, shortest distance through air |
| Minimum External Tracking (Creepage) | L(I02) | 4.0 min | mm | Measured from input terminals to output terminals, shortest distance path along body |
| Minimum Internal Gap (Internal Clearance) | | 0.017 min | mm | Insulation distance through insulation |
| Tracking Resistance (Comparative Tracking Index) | CTI | >400 | V | DIN IEC 112/VDE 0303 Part 1 |
| Isolation Group | | II | | Material Group (DIN VDE 0110, 1/89, Table 1) |

ADuM4223

Table 5.

| Parameter | Symbol | Value | Unit | Conditions |
|--|--------|-----------|-------|--|
| Rated Dielectric Insulation Voltage | | 5000 | V rms | 1 minute duration |
| Minimum External Air Gap (Clearance) | L(I01) | 7.6 min | mm | Measured from input terminals to output terminals, shortest distance through air |
| Minimum External Tracking (Creepage) | L(I02) | 7.6 min | mm | Measured from input terminals to output terminals, shortest distance path along body |
| Minimum Internal Gap (Internal Clearance) | | 0.017 min | mm | Insulation distance through insulation |
| Tracking Resistance (Comparative Tracking Index) | CTI | >400 | V | DIN IEC 112/VDE 0303 Part 1 |
| Isolation Group | | II | | Material Group (DIN VDE 0110, 1/89, Table 1) |

REGULATORY INFORMATION

The [ADuM3223](#) is approved or pending approval by the organizations listed in Table 6.

Table 6.

| UL | CSA | VDE |
|---|---|--|
| Recognized under UL 1577 Component Recognition Program ¹ | Approved under CSA Component Acceptance Notice 5A | Certified according to DIN V VDE V 0884-10 (VDE V 0884-10): 2006-12 ² |
| Single/Protection 3000 V rms Isolation Voltage | Basic insulation per CSA 60950-1-07 and IEC 60950-1, 380 V rms (537 V peak) maximum working voltage | Reinforced insulation, 560 V peak |
| File E214100 | File 205078 | File 2471900-4880-0001 |

¹ In accordance with UL 1577, each [ADuM3223](#) is proof tested by applying an insulation test voltage ≥ 3600 V rms for 1 second (current leakage detection limit = 6 μ A).

² In accordance with DIN V VDE V 0884-10, each [ADuM3223](#) is proof tested by applying an insulation test voltage ≥ 1050 V peak for 1 second (partial discharge detection limit = 5 pC). An asterisk (*) marking branded on the component designates DIN V VDE V 0884-10 approval.

The [ADuM4223](#) is approved or pending approval by the organizations listed in Table 7.

Table 7.

| UL | CSA | CQC | VDE |
|---|--|---|--|
| Recognized Under UL 1577 Component Recognition Program ¹ | Approved under CSA Component Acceptance Notice 5A | Approved under CQC11-471543-2012 | Certified according to DIN V VDE V 0884-10 (VDE V 0884-10): 2006-12 ² |
| Single/Protection 5000 V rms Isolation Voltage | Reinforced insulation per CSA 60950-1-07 and IEC 60950-1, 380 V rms (537 V peak) maximum working voltage; basic insulation per CSA 60950-1-07 and IEC 60950-1, 760 V rms (1074 V peak) maximum working voltage | Reinforced insulation per GB4943.1-2011, 380 V rms (537 V peak) maximum working voltage, tropical climate, altitude ≤ 5000 m; basic insulation per GB4943.1-2011, 600 V rms (848 V peak) maximum working voltage, tropical climate, altitude ≤ 5000 m | Reinforced insulation, 849 V peak |
| File E214100 | File 205078 | File CQC14001108627 | File 2471900-4880-0001 |

¹ In accordance with UL 1577, each [ADuM4223](#) is proof tested by applying an insulation test voltage ≥ 6000 V rms for 1 second (current leakage detection limit = 10 μ A).

² In accordance with DIN V VDE V 0884-10, each [ADuM4223](#) is proof tested by applying an insulation test voltage ≥ 1592 V peak for 1 second (partial discharge detection limit = 5 pC). An asterisk (*) marking branded on the component designates DIN V VDE V 0884-10 approval.

DIN V VDE V 0884-10 (VDE V 0884-10) INSULATION CHARACTERISTICS

These isolators are suitable for reinforced isolation only within the safety limit data. Maintenance of the safety data is ensured by protective circuits. The asterisk (*) marking on the package denotes DIN V VDE V 0884-10 approval for a 560 V peak working voltage.

Table 8. ADuM3223 VDE Characteristics

| Description | Conditions | Symbol | Characteristic | Unit |
|---|--|-------------|--------------------------------|--------|
| Installation Classification per DIN VDE 0110 For Rated Mains Voltage ≤ 150 V rms For Rated Mains Voltage ≤ 300 V rms For Rated Mains Voltage ≤ 400 V rms | | | I to IV I to III I to II | |
| Climatic Classification | | | 40/105/21 | |
| Pollution Degree per DIN VDE 0110, Table 1 | | | 2 | |
| Maximum Working Insulation Voltage | | V_{IORM} | 560 | V peak |
| Input-to-Output Test Voltage, Method B1 | $V_{IORM} \times 1.875 = V_{pd(m)}$, 100% production test, $t_{ini} = t_m = 1$ sec, partial discharge < 5 pC | $V_{pd(m)}$ | 1050 | V peak |
| Input-to-Output Test Voltage, Method A | $V_{IORM} \times 1.5 = V_{pd(m)}$, $t_{ini} = 60$ sec, $t_m = 10$ sec, partial discharge < 5 pC | $V_{pd(m)}$ | | |
| After Environmental Tests Subgroup 1 | | | 896 | V peak |
| After Input and/or Safety Test Subgroup 2 and Subgroup 3 | $V_{IORM} \times 1.2 = V_{pd(m)}$, $t_{ini} = 60$ sec, $t_m = 10$ sec, partial discharge < 5 pC | $V_{pd(m)}$ | 672 | V peak |
| Highest Allowable Overvoltage | | V_{IOTM} | 4242 | V peak |
| Surge Isolation Voltage | | V_{IOSM} | 6000 | V peak |
| Safety-Limiting Values | $V_{PEAK} = 10$ kV, 1.2 μs rise time, 50 μs, 50% fall time Maximum value allowed in the event of a failure (see Figure 2) | | | |
| Maximum Junction Temperature | | T_S | 150 | °C |
| Safety Total Dissipated Power | | P_S | 1.64 | W |
| Insulation Resistance at T_S | $V_{IO} = 500$ V | R_S | >10 ⁹ | Ω |

Table 9. ADuM4223 VDE Characteristics

| Description | Conditions | Symbol | Characteristic | Unit |
|---|--|-------------|--------------------------------|--------|
| Installation Classification per DIN VDE 0110 For Rated Mains Voltage ≤ 150 V rms For Rated Mains Voltage ≤ 300 V rms For Rated Mains Voltage ≤ 400 V rms | | | I to IV I to III I to II | |
| Climatic Classification | | | 40/105/21 | |
| Pollution Degree per DIN VDE 0110, Table 1 | | | 2 | |
| Maximum Working Insulation Voltage | | V_{IORM} | 849 | V peak |
| Input-to-Output Test Voltage, Method B1 | $V_{IORM} \times 1.875 = V_{pd(m)}$, 100% production test, $t_{ini} = t_m = 1$ sec, partial discharge < 5 pC | $V_{pd(m)}$ | 1592 | V peak |
| Input-to-Output Test Voltage, Method A | $V_{IORM} \times 1.5 = V_{pd(m)}$, $t_{ini} = 60$ sec, $t_m = 10$ sec, partial discharge < 5 pC | $V_{pd(m)}$ | | |
| After Environmental Tests Subgroup 1 | | | 1273 | V peak |
| After Input and/or Safety Test Subgroup 2 and Subgroup 3 | $V_{IORM} \times 1.2 = V_{pd(m)}$, $t_{ini} = 60$ sec, $t_m = 10$ sec, partial discharge < 5 pC | $V_{pd(m)}$ | 1018 | V peak |
| Highest Allowable Overvoltage | | V_{IOTM} | 7071 | V peak |
| Surge Isolation Voltage | | V_{IOSM} | 6000 | V peak |
| Safety-Limiting Values | $V_{PEAK} = 10$ kV, 1.2 μs rise time, 50 μs, 50% fall time Maximum value allowed in the event of a failure (see Figure 3) | | | |
| Maximum Junction Temperature | | T_S | 150 | °C |
| Safety Total Dissipated Power | | P_S | 2.77 | W |
| Insulation Resistance at T_S | $V_{IO} = 500$ V | R_S | >10 ⁹ | Ω |

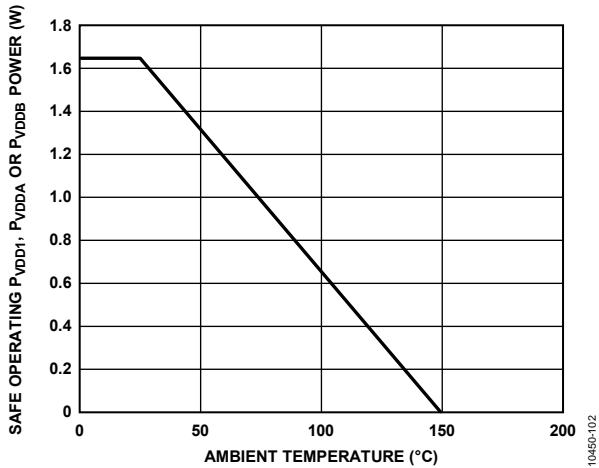

Figure 2. ADuM3223 Thermal Derating Curve, Dependence of Safety-Limiting Values on Case Temperature, per DIN V VDE V 0884-10

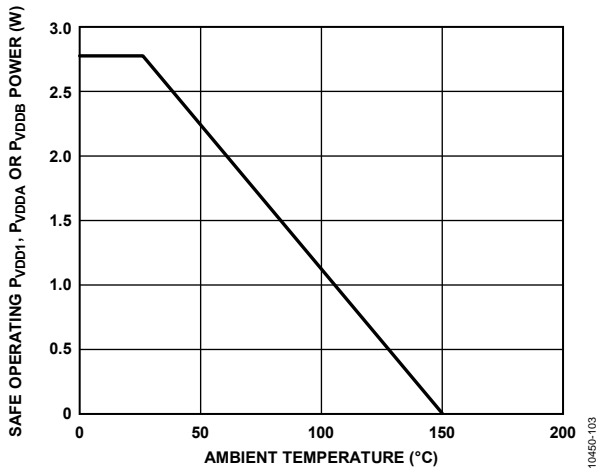

Figure 3. ADuM4223 Thermal Derating Curve, Dependence of Safety-Limiting Values on Case Temperature, per DIN V VDE V 0884-10

RECOMMENDED OPERATING CONDITIONS

Table 10.

| Parameter | Symbol | Min | Max | Unit |
|--|---------------------------------------|-----|------|-------|
| Operating Junction Temperature | T _J | -40 | +125 | °C |
| Supply Voltages ¹ | | | | |
| V _{DD1} | V _{DD1} | 3.0 | 5.5 | V |
| V _{DDA} , V _{ddb} | V _{DDA} , V _{ddb} | 4.5 | 18 | V |
| V _{DD1} Rise Time | T _{VDD1} | | 1 | V/μs |
| V _{DDA} , V _{ddb} Rise Time | T _{VDDA} , T _{Vddb} | | 10 | V/μs |
| Maximum Input Signal Rise and Fall Times | T _{VIA} , T _{VIB} | | 1 | ms |
| Common-Mode Transient Immunity, Static ² | | -50 | +50 | kV/μs |
| Common-Mode Transient Immunity, Dynamic ³ | | -25 | +25 | kV/μs |

¹ All voltages are relative to their respective ground. See the Applications Information section for information on immunity to external magnetic fields.
² Static common-mode transient immunity is defined as the largest dv/dt between GND₁ and GND_A/GND_B, with inputs held either high or low such that the output voltage remains either above 0.8 × V_{DD2} for V_{IA}/V_{IB} = high or 0.8 V for V_{IA}/V_{IB} = low. Operation with transients above the recommended levels may cause momentary data upsets.
³ Dynamic common-mode transient immunity is defined as the largest dv/dt between GND₁ and GND_A/GND_B, with the switching edge coincident with the transient test pulse. Operation with transients above the recommended levels may cause momentary data upsets.

ABSOLUTE MAXIMUM RATINGS

Ambient temperature = 25°C, unless otherwise noted.

Table 11.

| Parameter | Symbol | Rating |
|--|------------------------------|--------------------------------------|
| Storage Temperature | T_{ST} | -55°C to +150°C |
| Operating Junction Temperature | T_J | -40°C to +150°C |
| Supply Voltages ¹ | V_{DD1} | -0.5 V to +7.0 V |
| | V_{DDA}, V_{DDB} | -0.5 V to +20 V |
| Input Voltage ¹ | $V_{IA}, V_{IB},$ DISABLE | -0.5 V to $V_{DD1} + 0.5$ V |
| Output Voltage ¹ | V_{OA} | -0.5 V to $V_{DDA} + 0.5$ V |
| | V_{OB} | -0.5 V to $V_{DDB} + 0.5$ V |
| Average Output Current, per Pin ² | I_o | -35 mA to +35 mA |
| Common-Mode Transients ³ | CM_H, CM_L | -100 kV/ μ s to +100 kV/ μ s |

¹ All voltages are relative to their respective ground.

² See Figure 2 and Figure 3 for information on maximum allowable current for various temperatures.

³ Refers to common-mode transients across the insulation barrier. Common-mode transients exceeding the absolute maximum rating can cause latch-up or permanent damage.

Stresses at or above those listed under Absolute Maximum Ratings may cause permanent damage to the product. This is a stress rating only; functional operation of the product at these or any other conditions above those indicated in the operational section of this specification is not implied. Operation beyond the maximum operating conditions for extended periods may affect product reliability.

ESD CAUTION



ESD (electrostatic discharge) sensitive device. Charged devices and circuit boards can discharge without detection. Although this product features patented or proprietary protection circuitry, damage may occur on devices subjected to high energy ESD. Therefore, proper ESD precautions should be taken to avoid performance degradation or loss of functionality.

Table 12. Maximum Continuous Working Voltage¹

| Parameter | Max | Unit | Constraint |
|-------------------------------|------|--------|--------------------------|
| AC Voltage, Bipolar Waveform | 565 | V peak | 50-year minimum lifetime |
| AC Voltage, Unipolar Waveform | 1131 | V peak | 50-year minimum lifetime |
| DC Voltage | 1131 | V peak | 50-year minimum lifetime |

¹ Refers to the continuous voltage magnitude imposed across the isolation barrier. See the Insulation Lifetime section for more details.

Table 13. Truth Table ADuM3223/ADuM4223 (Positive Logic)¹

| DISABLE ² | V _{IA} Input | V _{IB} Input | V _{DD1} State | V _{DDA} /V _{DDB} State | V _{OA} Output | V _{OB} Output | Notes |
|----------------------|--------------------------|--------------------------|------------------------|--|------------------------|------------------------|---|
| L | L | L | Powered | Powered | L | L | |
| L | L | H | Powered | Powered | L | H | |
| L | H | L | Powered | Powered | H | L | |
| L | H | H | Powered | Powered | H | H | |
| H | X | X | Powered | Powered | L | L | |
| L | L | L | Unpowered | Powered | L | L | |
| X | X | X | Powered | Unpowered | L | L | Outputs return to the input state within 1 μ s of V _{DD1} power restoration. Outputs return to the input state within 50 μ s of V _{DDA} /V _{DDB} power restoration. |

¹ X means don't care, L means low, and H means high.

² Reaction to DISABLE is approximately one propagation delay.

PIN CONFIGURATION AND FUNCTION DESCRIPTIONS

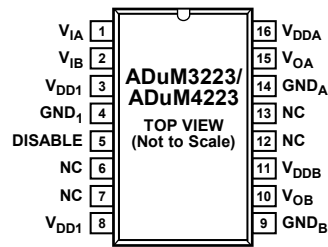

NOTES
 1. NC = NO CONNECT.
 DO NOT CONNECT TO THIS PIN.

10450-003

Figure 4. Pin Configuration

Table 14. ADuM3223/ADuM4223 Pin Function Descriptions

| Pin No. ¹ | Mnemonic | Description |
|----------------------|------------------|--|
| 1 | V _{IA} | Logic Input A. |
| 6, 7, 12, 13 | NC | No Connect. Do not connect to this pin |
| 2 | V _{IB} | Logic Input B. |
| 3, 8 | V _{DD1} | Input Supply Voltage. |
| 4 | GND ₁ | Ground Reference for Input Logic Signals. |
| 5 | DISABLE | Input Disable. When this pin is high, it disables the isolator inputs setting outputs to a low state. The reaction to the DISABLE pin signal is approximately equal to the normal propagation delay. |
| 9 | GND _B | Ground Reference for Output B. |
| 10 | V _{OB} | Output B. |
| 11 | V _{DDB} | Output B Supply Voltage. |
| 14 | GND _A | Ground Reference for Output A. |
| 15 | V _{OA} | Output A. |
| 16 | V _{DDA} | Output A Supply Voltage. |

¹ Pin 3 and Pin 8 are internally connected; connecting both pins to supply V_{DD1} is recommended.

For specific layout guidelines, refer to the [AN-1109 Application Note, Recommendations for Control of Radiated Emissions with iCoupler Devices](#).

TYPICAL PERFORMANCE CHARACTERISTICS



Figure 5. Output Waveform for 2 nF Load with 12 V Output Supply

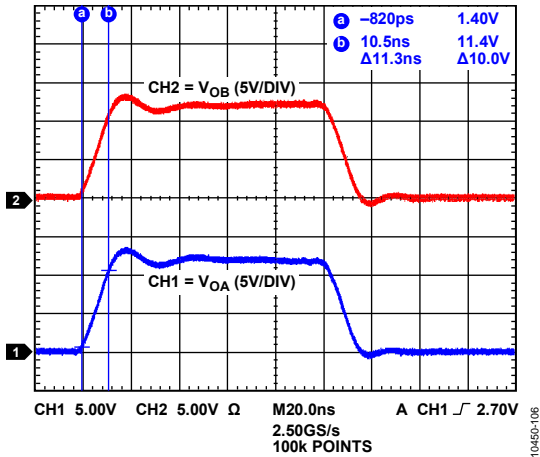

Figure 6. Output Matching and Rise Time Waveforms for 2 nF Load with 12 V Output Supply

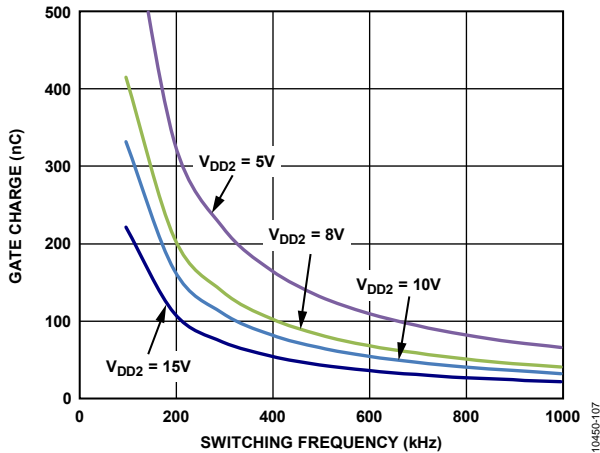

Figure 7. Typical ADuM3223 Maximum Load vs. Frequency ($R_G = 1 \Omega$)

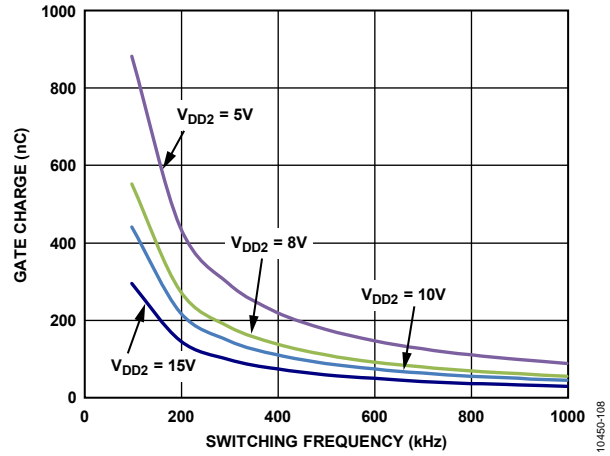

Figure 8. Typical ADuM4223 Maximum Load vs. Frequency ($R_G = 1 \Omega$)

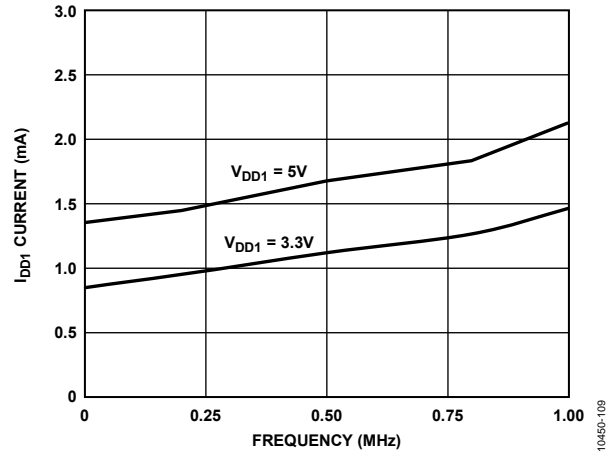

Figure 9. Typical I_{DD1} Supply Current vs. Frequency

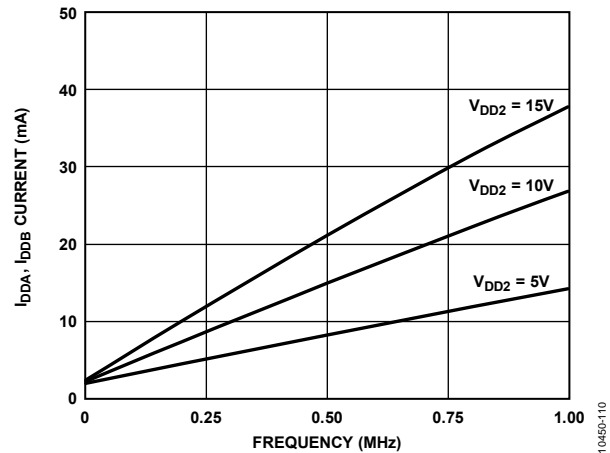

Figure 10. Typical I_{DDA} , I_{ddb} Supply Current vs. Frequency with 2 nF Load

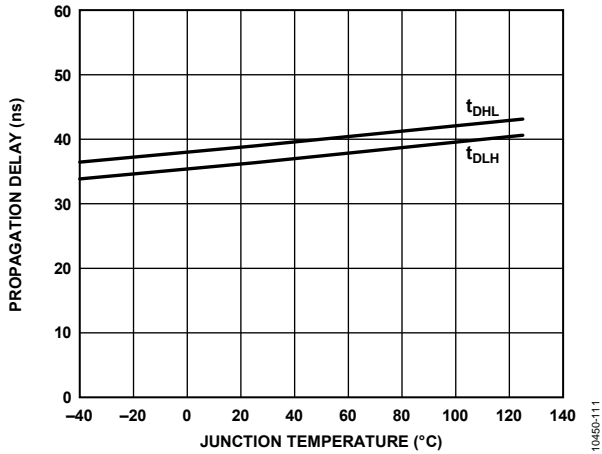

Figure 11. Typical Propagation Delay vs. Temperature

10460-111

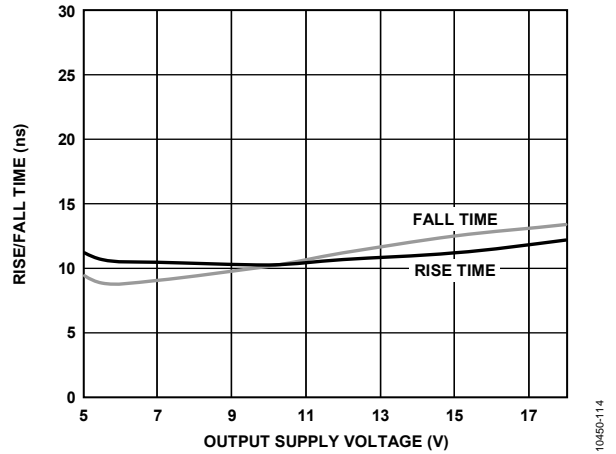

Figure 14. Typical Rise/Fall Time Variation vs. Output Supply Voltage

10460-114

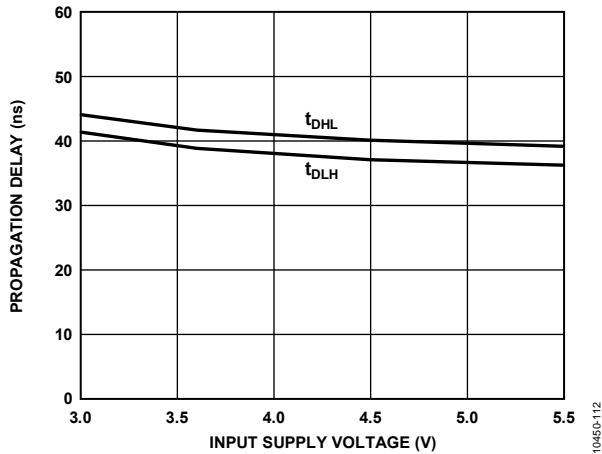

Figure 12. Typical Propagation Delay vs. Input Supply Voltage, $V_{DDA}, V_{DDB} = 12\text{ V}$

10460-112

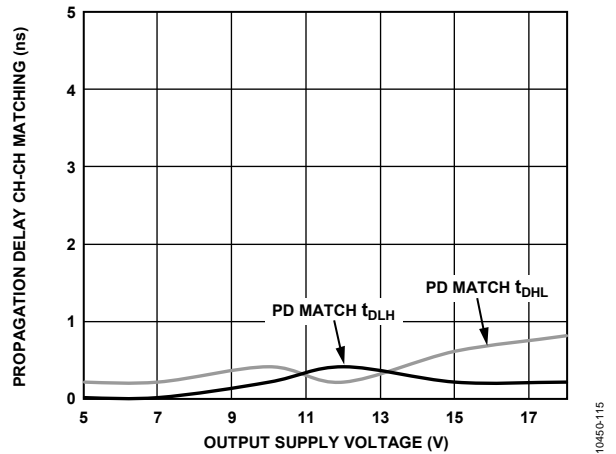

Figure 15. Typical Propagation Delay, Channel-to-Channel Matching vs. Output Supply Voltage

10460-115

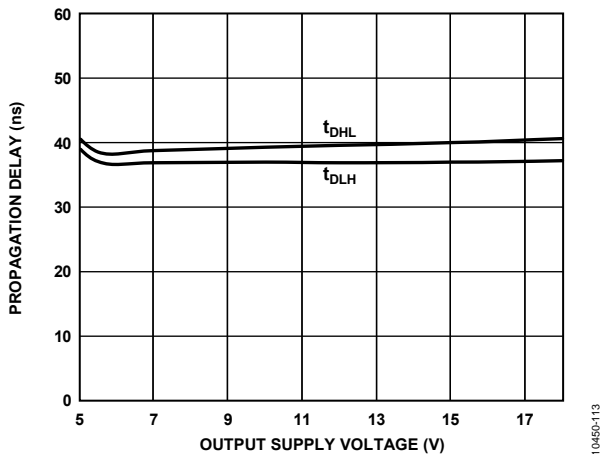

Figure 13. Typical Propagation Delay vs. Output Supply Voltage, $V_{DD1} = 5\text{ V}$

10460-113

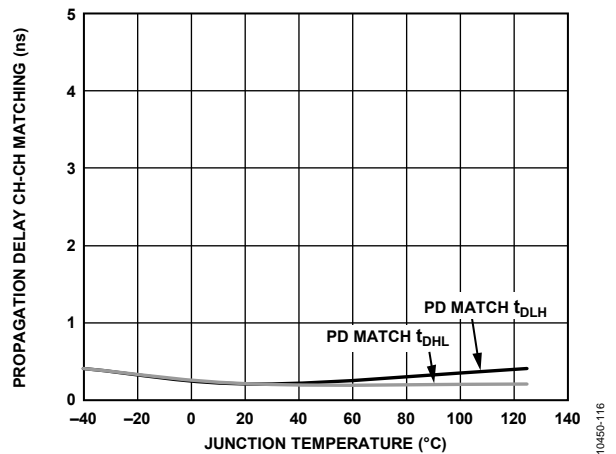

Figure 16. Typical Propagation Delay, Channel-to-Channel Matching vs. Temperature, $V_{DDA}, V_{DDB} = 12\text{ V}$

10460-116

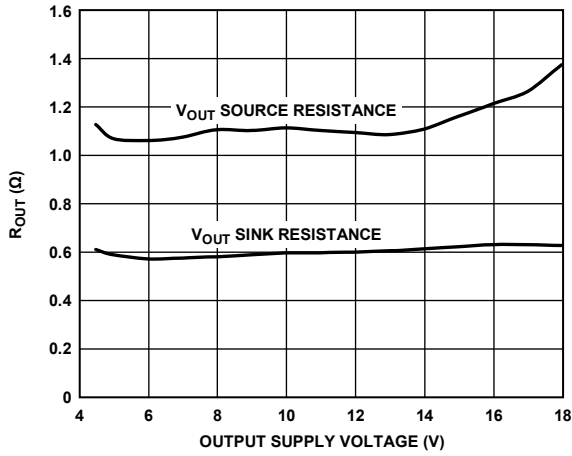

Figure 17. Typical Output Resistance vs. Output Supply Voltage

10450-117

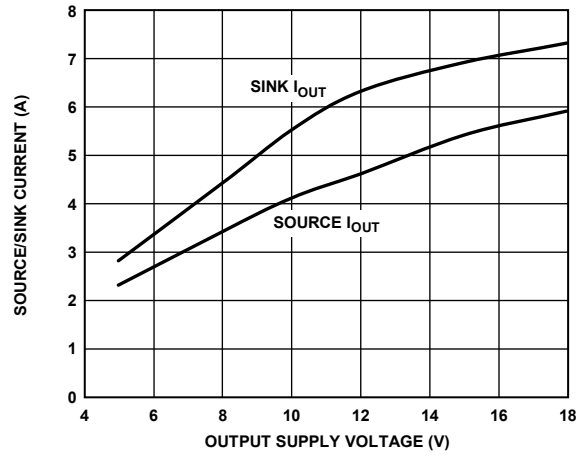

Figure 18. Typical Output Current vs. Output Supply Voltage

10450-118

APPLICATIONS INFORMATION

PC BOARD LAYOUT

The ADuM3223/ADuM4223 digital isolators require no external interface circuitry for the logic interfaces. Power supply bypassing is required at the input and output supply pins, as shown in Figure 19. Use a small ceramic capacitor with a value between 0.01 μF and 0.1 μF to provide a good high frequency bypass. On the output power supply pin, V_{DDA} or V_{DDB} , it is also recommended to add a 10 μF capacitor to provide the charge required to drive the gate capacitance at the ADuM3223/ADuM4223 outputs. On the output supply pin, the bypass capacitor use of vias should be avoided or multiple vias should be employed to reduce the inductance in the bypassing. The total lead length between both ends of the smaller capacitor and the input or output power supply pin should not exceed 5 mm.

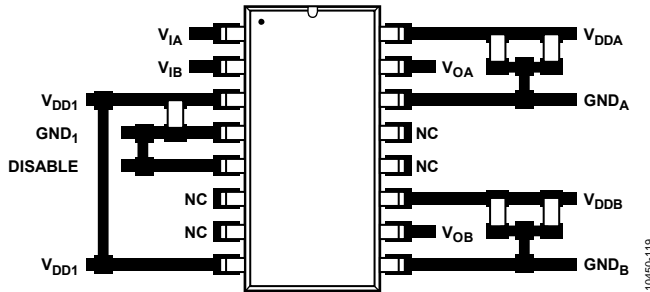

Figure 19. Recommended PCB Layout

PROPAGATION DELAY-RELATED PARAMETERS

Propagation delay is a parameter that describes the time it takes a logic signal to propagate through a component. The propagation delay to a logic low output can differ from the propagation delay to a logic high output. The ADuM3223/ADuM4223 specify t_{DLH} (see Figure 20) as the time between the rising input high logic threshold, V_{IH} , to the output rising 10% threshold. Likewise, the falling propagation delay, t_{DHL} , is defined as the time between the input falling logic low threshold, V_{IL} , and the output falling 90% threshold. The rise and fall times are dependent on the loading conditions and are not included in the propagation delay, which is the industry standard for gate drivers.

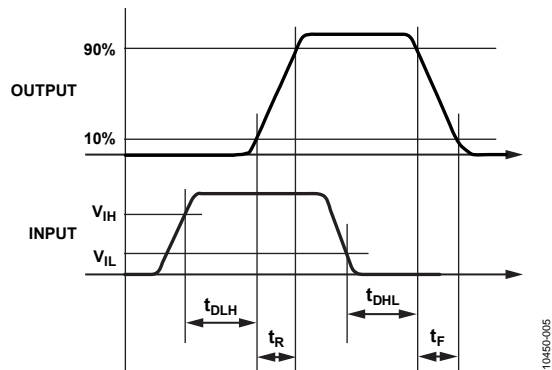

Figure 20. Propagation Delay Parameters

Channel-to-channel matching refers to the maximum amount that the propagation delay differs between channels within a single ADuM3223/ADuM4223 component.

Propagation delay skew refers to the maximum amount that the propagation delay differs between multiple ADuM3223/ADuM4223 components operating under the same conditions.

THERMAL LIMITATIONS AND SWITCH LOAD CHARACTERISTICS

For isolated gate drivers, the necessary separation between the input and output circuits prevents the use of a single thermal pad beneath the part, and heat is, therefore, dissipated mainly through the package pins.

Package thermal dissipation limits the performance of switching frequency vs. output load, as illustrated in Figure 7 and Figure 8 for the maximum load capacitance that can be driven with a 1 Ω series gate resistance for different values of output voltage. For example, this curve shows that a typical ADuM3223 can drive a large MOSFET with 140 nC gate charge at 8 V output (which is equivalent to a 17 nF load) up to a frequency of about 300 kHz.

Each of the ADuM3223/ADuM4223 isolator outputs has a thermal shutdown protection function, which sets an output to a logic low when the rising junction temperature typically reaches 150°C, and turns back on after the junction temperature falls from the shutdown by approximately 10°C.

OUTPUT LOAD CHARACTERISTICS

The ADuM3223/ADuM4223 output signals depend on the characteristics of the output load, which is typically an N-channel MOSFET. The driver output response to an N-channel MOSFET load can be modeled with a switch output resistance (R_{SW}), an inductance due to the printed circuit board trace (L_{TRACE}), a series gate resistor (R_{GATE}), and a gate-to-source capacitance (C_{GS}), as shown in Figure 21.

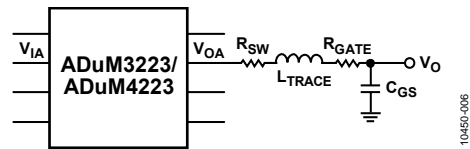

Figure 21. RLC Model of the Gate of an N-Channel MOSFET

R_{SW} is the switch resistance of the internal ADuM3223/ADuM4223 driver output, which is about 1.1 Ω . R_{GATE} is the intrinsic gate resistance of the MOSFET and any external series resistance. A MOSFET that requires a 4 A gate driver has a typical intrinsic gate resistance of about 1 Ω and a gate-to-source capacitance, C_{GS} , of between 2 nF and 10 nF. L_{TRACE} is the inductance of the printed circuit board trace, typically a value of 5 nH or less for a well-designed layout with a very short and wide connection from the ADuM3223/ADuM4223 output to the gate of the MOSFET.

The following equation defines the Q factor of the RLC circuit, which indicates how the ADuM3223/ADuM4223 output responds to a step change. For a well-damped output, Q is less than 1. Adding a series gate resistance dampens the output response.

$$Q = \frac{1}{(R_{SW} + R_{GATE})} \times \sqrt{\frac{L_{TRACE}}{C_{GS}}}$$

In Figure 5, the ADuM3223/ADuM4223 output waveforms for a 12 V output are shown for a C_{GS} of 2 nF. Note the small amount of ringing of the output in Figure 5 with C_{GS} of 2 nF, R_{SW} of 1.1 Ω , R_{GATE} of 0 Ω , and a calculated Q factor of 0.75, where less than 1 is desired for good damping.

Output ringing can be reduced by adding a series gate resistance to dampen the response. For applications of less than 1 nF load, it is recommended to add a series gate resistor of about 2 Ω to 5 Ω .

BOOT-STRAPPED HALF-BRIDGE OPERATION

The ADuM3223/ADuM4223 are well suited to the operation of two output gate signals that are referenced to separate grounds, as in the case of a half-bridge configuration. Because isolated auxiliary supplies are often expensive, it is beneficial to reduce the amount of supplies. One method to perform this is to use a boot-strap configuration for the high-side supply of the ADuM3223/ADuM4223. In this topology, the decoupling capacitor, C_A , acts as the energy storage for the high-side supply, and is filled whenever the low-side switch is closed, bringing GND_A to GND_B . During the charging time of C_A , the dv/dt of the V_{DDA} voltage must be controlled to reduce the possibility of glitches on the output. Keeping the dv/dt below 10 V/ μ s is recommended for the ADuM3223/ADuM4223. This can be controlled by introducing a series resistance, R_{BOOT} , into the charging path of C_A . As an example, if V_{AUX} is 12 V, C_A has a total capacitance of 10 μ F, and the forward voltage drop of the bootstrap diode is 1 V:

$$R_{BOOT} = \frac{V_{AUX} - V_{D_{BOOT}}}{C_A \times dv/dt_{max}} = \frac{12\text{ V} - 1\text{ V}}{10\ \mu\text{F} \times 10\text{ V}/\mu\text{s}} = 0.11\ \Omega$$

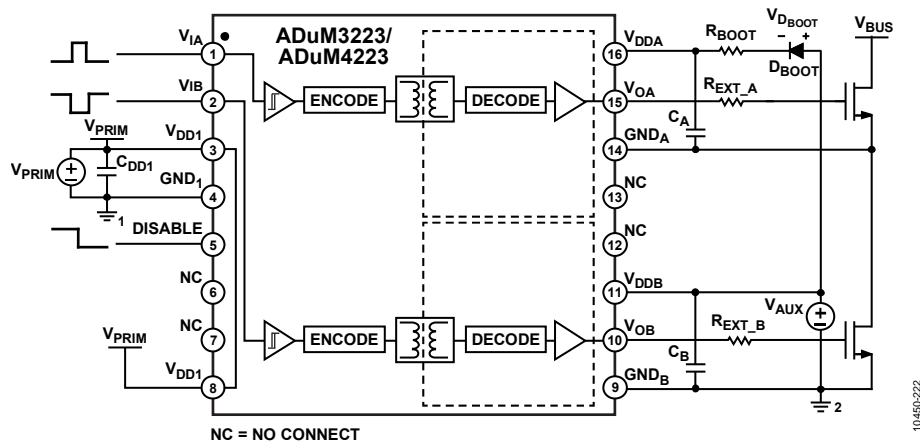

Figure 22. Circuit of Bootstrapped Half-Bridge Operation

DC CORRECTNESS AND MAGNETIC FIELD IMMUNITY

Positive and negative logic transitions at the isolator input cause narrow (~1 ns) pulses to be sent to the decoder via the transformer. The decoder is bistable and is, therefore, either set or reset by the pulses, indicating input logic transitions. In the absence of logic transitions of more than 1 μ s at the input, a periodic set of refresh pulses indicative of the correct input state are sent to ensure dc correctness at the output.

If the decoder receives no internal pulses for more than about 3 μ s, the input side is assumed to be unpowered or nonfunctional, in which case, the isolator output is forced to a default low state by the watchdog timer circuit. In addition, the outputs are in a low default state while the power is coming up before the UVLO threshold is crossed.

The ADuM3223/ADuM4223 is immune to external magnetic fields. The limitation on the ADuM3223/ADuM4223 magnetic field immunity is set by the condition in which induced voltage in the transformer receiving coil is sufficiently large to either falsely set or reset the decoder. The following analysis defines the conditions under which this can occur. The 3 V operating condition of the ADuM3223/ADuM4223 is examined because it represents the most susceptible mode of operation. The pulses at the transformer output have an amplitude greater than 1.0 V. The decoder has a sensing threshold at about 0.5 V, therefore establishing a 0.5 V margin in which induced voltages can be tolerated. The voltage induced across the receiving coil is given by

$$V = (-d\beta/dt) \Sigma \pi r_n^2, n = 1, 2, \dots, N$$

where:

β is the magnetic flux density (gauss).

N is the number of turns in the receiving coil.

r_n is the radius of the nth turn in the receiving coil (cm).

Given the geometry of the receiving coil in the [ADuM3223/ADuM4223](#) and an imposed requirement that the induced voltage is, at most, 50% of the 0.5 V margin at the decoder, a maximum allowable magnetic field is calculated, as shown in Figure 23.

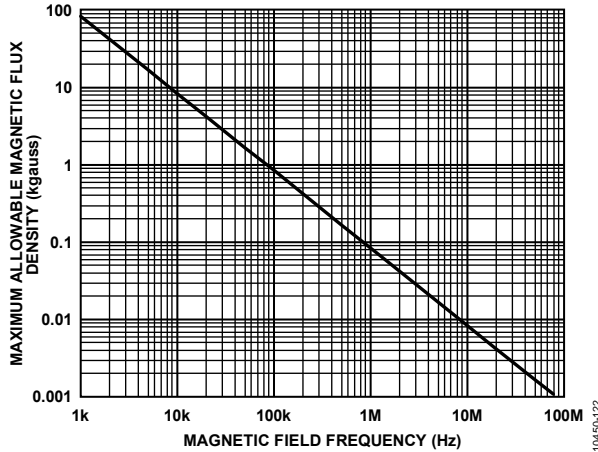

Figure 23. Maximum Allowable External Magnetic Flux Density

For example, at a magnetic field frequency of 1 MHz, the maximum allowable magnetic field of 0.08 kgauss induces a voltage of 0.25 V at the receiving coil. This is about 50% of the sensing threshold and does not cause a faulty output transition. Similarly, if such an event were to occur during a transmitted pulse (and had the worst-case polarity), the received pulse is reduced from >1.0 V to 0.75 V, still well above the 0.5 V sensing threshold of the decoder.

The preceding magnetic flux density values correspond to specific current magnitudes at given distances away from the [ADuM3223/ADuM4223](#) transformers. Figure 24 expresses these allowable current magnitudes as a function of frequency for selected distances. As shown, the [ADuM3223/ADuM4223](#) are immune and only can be affected by extremely large currents operated at a high frequency and very close to the component. For the 1 MHz example, a 0.2 kA current must be placed 5 mm away from the [ADuM3223/ADuM4223](#) to affect the component's operation.

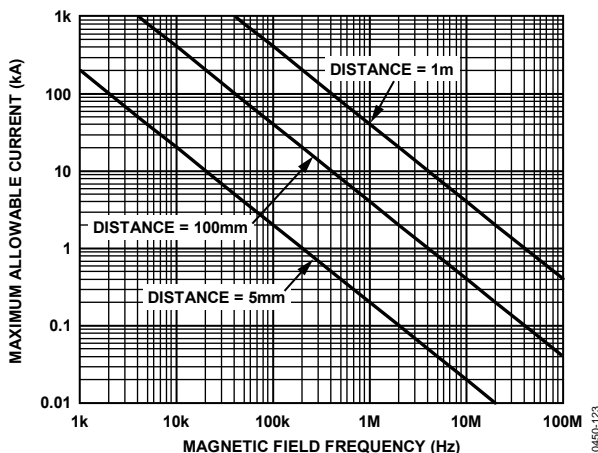

Figure 24. Maximum Allowable Current for Various Current-to-ADuM3223/ADuM4223 Spacings

POWER CONSUMPTION

The supply current at a given channel of the [ADuM3223/ADuM4223](#) isolator is a function of the supply voltage, channel data rate, and channel output load.

During the driving of a MOSFET gate, the driver must dissipate power. This power is not insignificant and can lead to thermal shutdown (TSD) if considerations are not made. The gate of a MOSFET can be simulated approximately as a capacitive load. Due to Miller capacitance and other nonlinearities, it is common practice to take the stated input capacitance, C_{ISS} , of a given MOSFET and multiply it by a factor of 5 to arrive at a conservative estimate to approximate the load being driven. With this value, the estimated total power dissipation per channel due to switching action is given by

$$P_{DISS} = C_{EST} \times (V_{DDx})^2 \times f_s$$

where:

$$C_{EST} = C_{ISS} \times 5.$$

f_s is the switching frequency.

Alternately, use the gate charge to obtain a more precise value for P_{DISS} .

$$P_{DISS} = Q_{GATE} \times V_{DDx} \times f_s$$

where:

Q_{GATE} is the gate charge for the MOSFET.

f_s is the switching frequency.

This power dissipation is shared between the internal on resistances of the internal gate driver switches and the external gate resistances, R_{GON} and R_{GOFF} . The ratio of the internal gate resistances to the total series resistance allows the calculation of losses seen within the [ADuM3223/ADuM4223](#) chips per channel.

$$P_{DISS_IC} = P_{DISS} \times \frac{1}{2} \times (R_{DS(on)P} / (R_{EXT_X} + R_{DS(on)P}) + R_{DS(on)N} / (R_{EXT_X} + R_{DS(on)N}))$$

Taking the power dissipation found inside the chip and multiplying it by θ_{JA} gives the rise above ambient temperature that the [ADuM3223/ADuM4223](#) experiences, multiplied by two to reflect that there are two channels.

$$T_J = \theta_{JA} \times 2 \times P_{DISS_IC} + T_{AMB}$$

For the device to remain within specification, T_J must not exceed 125°C. If T_J exceeds 150°C (typical), the device enters TSD.

Quiescent power dissipation may also be added to give a more accurate number for temperature rise, but the switching power losses are often the largest source of power dissipation, and quiescent losses can often be ignored. To calculate the total supply current, the quiescent supply currents for each input and output channel corresponding to $I_{DD1(Q)}$, $I_{DDA(Q)}$, and $I_{DDB(Q)}$ are added. The full equation for the T_J becomes

$$T_J = \theta_{JA} \times (2 \times P_{DISS_IC} + V_{DD1} \times I_{DD1(Q)} + V_{DDA} \times I_{DDA(Q)} + V_{DDB} \times I_{DDB(Q)}) + T_{AMB}$$

Figure 9 provides total input I_{DD1} supply current as a function of data rate for both input channels. Figure 10 provides total I_{DDA} or I_{ddb} supply current as a function of data rate for both outputs loaded with 2 nF capacitance.

INSULATION LIFETIME

All insulation structures eventually break down when subjected to voltage stress over a sufficiently long period. The rate of insulation degradation is dependent on the characteristics of the voltage waveform applied across the insulation. In addition to the testing performed by the regulatory agencies, Analog Devices carries out an extensive set of evaluations to determine the lifetime of the insulation structure within the [ADuM3223/ADuM4223](#).

Analog Devices performs accelerated life testing using voltage levels higher than the rated continuous working voltage. Acceleration factors for several operating conditions are determined. These factors allow calculation of the time to failure at the actual working voltage.

The values shown in Table 12 summarize the peak voltage for 50 years of service life for a bipolar ac operating condition, and the maximum CSA/VDE approved working voltages. In many cases, the approved working voltage is higher than 50-year service life voltage. Operation at these high working voltages can lead to shortened insulation life in some cases.

The insulation lifetime of the [ADuM3223/ADuM4223](#) depends on the voltage waveform type imposed across the isolation barrier. The *iCoupler* insulation structure degrades at different rates depending on whether the waveform is bipolar ac, unipolar ac, or dc. Figure 25, Figure 26, and Figure 27 illustrate these different isolation voltage waveforms.

A bipolar ac voltage environment is the worst case for the *iCoupler* products and is the 50-year operating lifetime that Analog Devices recommends for maximum working voltage. In the case of unipolar ac or dc voltage, the stress on the insulation is significantly lower. This allows operation at higher working voltages while still achieving a 50-year service life. Any crossinsulation voltage waveform that does not conform to Figure 26 or Figure 27 should be treated as a bipolar ac waveform, and its peak voltage should be limited to the 50-year lifetime voltage value listed in Table 12.

Note that the voltage presented in Figure 26 is shown as sinusoidal for illustration purposes only. It is meant to represent any voltage waveform varying between 0 V and some limiting value. The limiting value can be positive or negative, but the voltage cannot cross 0 V.

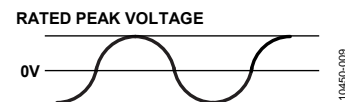

Figure 25. Bipolar AC Waveform

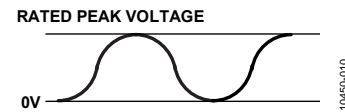

Figure 26. Unipolar AC Waveform

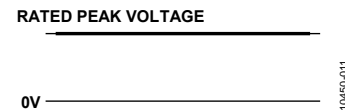
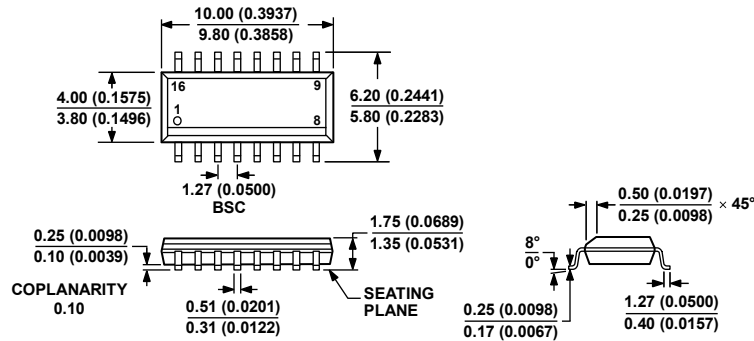

Figure 27. DC Waveform

OUTLINE DIMENSIONS



COMPLIANT TO JEDEC STANDARDS MS-012-AC
 CONTROLLING DIMENSIONS ARE IN MILLIMETERS; INCH DIMENSIONS
 (IN PARENTHESES) ARE ROUNDED-OFF MILLIMETER EQUIVALENTS FOR
 REFERENCE ONLY AND ARE NOT APPROPRIATE FOR USE IN DESIGN.

Figure 28. 16-Lead Standard Small Outline Package [SOIC_N]
 Narrow Body
 (R-16)

Dimensions shown in millimeters and (inches)

060606-A

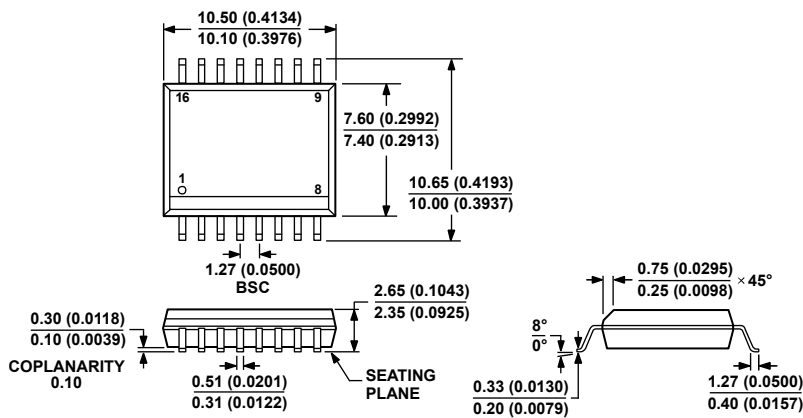

COMPLIANT TO JEDEC STANDARDS MS-013-AA
 CONTROLLING DIMENSIONS ARE IN MILLIMETERS; INCH DIMENSIONS
 (IN PARENTHESES) ARE ROUNDED-OFF MILLIMETER EQUIVALENTS FOR
 REFERENCE ONLY AND ARE NOT APPROPRIATE FOR USE IN DESIGN.

Figure 29. 16-Lead Standard Small Outline Package [SOIC_W]
 Wide Body
 (RW-16)

Dimensions shown in millimeters and (inches)

03-27-2007-B

ORDERING GUIDE

| Model ^{1, 2} | No. of Channels | Output Peak Current (A) | Minimum Output Voltage (V) | Temperature Range | Package Description | Package Option | Ordering Quantity |
|-----------------------|-----------------|-------------------------|----------------------------|-------------------|-----------------------------------|----------------|-------------------|
| ADuM3223ARZ | 2 | 4 | 4.5 | -40°C to +125°C | 16-Lead SOIC_N | R-16 | |
| ADuM3223ARZ-RL7 | 2 | 4 | 4.5 | -40°C to +125°C | 16-Lead SOIC_N, 7" Tape and Reel | R-16 | 1,000 |
| ADuM3223BRZ | 2 | 4 | 7.5 | -40°C to +125°C | 16-Lead SOIC_N | R-16 | |
| ADuM3223BRZ-RL7 | 2 | 4 | 7.5 | -40°C to +125°C | 16-Lead SOIC_N, 7" Tape and Reel | R-16 | 1,000 |
| ADuM3223CRZ | 2 | 4 | 11.5 | -40°C to +125°C | 16-Lead SOIC_N | R-16 | |
| ADuM3223CRZ-RL7 | 2 | 4 | 11.5 | -40°C to +125°C | 16-Lead SOIC_N, 7" Tape and Reel | R-16 | 1,000 |
| ADuM3223WARZ | 2 | 4 | 4.5 | -40°C to +125°C | 16-Lead SOIC_N | R-16 | |
| ADuM3223WARZ-RL7 | 2 | 4 | 4.5 | -40°C to +125°C | 16-Lead SOIC_N, 7" Tape and Reel | R-16 | 1,000 |
| ADuM3223WBRZ | 2 | 4 | 7.5 | -40°C to +125°C | 16-Lead SOIC_N | R-16 | |
| ADuM3223WBRZ-RL7 | 2 | 4 | 7.5 | -40°C to +125°C | 16-Lead SOIC_N, 7" Tape and Reel | R-16 | 1,000 |
| ADuM3223WCRZ | 2 | 4 | 11.5 | -40°C to +125°C | 16-Lead SOIC_N | R-16 | |
| ADuM3223WCRZ-RL7 | 2 | 4 | 11.5 | -40°C to +125°C | 16-Lead SOIC_N, 7" Tape and Reel | R-16 | 1,000 |
| ADuM4223ARWZ | 2 | 4 | 4.5 | -40°C to +125°C | 16-Lead SOIC_W | RW-16 | |
| ADuM4223ARWZ-RL | 2 | 4 | 4.5 | -40°C to +125°C | 16-Lead SOIC_W, 13" Tape and Reel | RW-16 | 1,000 |
| ADuM4223BRWZ | 2 | 4 | 7.5 | -40°C to +125°C | 16-Lead SOIC_W | RW-16 | |
| ADuM4223BRWZ-RL | 2 | 4 | 7.5 | -40°C to +125°C | 16-Lead SOIC_W, 13" Tape and Reel | RW-16 | 1,000 |
| ADuM4223CRWZ | 2 | 4 | 11.5 | -40°C to +125°C | 16-Lead SOIC_W | RW-16 | |
| ADuM4223CRWZ-RL | 2 | 4 | 11.5 | -40°C to +125°C | 16-Lead SOIC_W, 13" Tape and Reel | RW-16 | 1,000 |
| ADuM4223WARWZ | 2 | 4 | 4.5 | -40°C to +125°C | 16-Lead SOIC_W | RW-16 | |
| ADuM4223WARWZ-RL | 2 | 4 | 4.5 | -40°C to +125°C | 16-Lead SOIC_W, 13" Tape and Reel | RW-16 | 1,000 |
| ADuM4223WBRWZ | 2 | 4 | 7.5 | -40°C to +125°C | 16-Lead SOIC_W | RW-16 | |
| ADuM4223WBRWZ-RL | 2 | 4 | 7.5 | -40°C to +125°C | 16-Lead SOIC_W, 13" Tape and Reel | RW-16 | 1,000 |
| ADuM4223WCRWZ | 2 | 4 | 11.5 | -40°C to +125°C | 16-Lead SOIC_W | RW-16 | |
| ADuM4223WCRWZ-RL | 2 | 4 | 11.5 | -40°C to +125°C | 16-Lead SOIC_W, 13" Tape and Reel | RW-16 | 1,000 |
| EVAL-ADuM3223AEBZ | 2 | 4 | 4.5 | -40°C to +125°C | ADuM3223 evaluation board | | |
| EVAL-ADuM4223AEBZ | 2 | 4 | 4.5 | -40°C to +125°C | ADuM4223 evaluation board | | |

¹ Z = RoHS Compliant Part.

² W = Qualified for Automotive Applications.

AUTOMOTIVE PRODUCTS

The [ADuM3223W](#) and [ADuM4223W](#) models are available with controlled manufacturing to support the quality and reliability requirements of automotive applications. Note that these automotive models may have specifications that differ from the commercial models; therefore, designers should review the Specifications section of this data sheet carefully. Only the automotive grade products shown are available for use in automotive applications. Contact your local Analog Devices account representative for specific product ordering information and to obtain the specific Automotive Reliability reports for these models.