

spec ref	-	dr	Mark Lauermann	2012/07/02	projection	MM	size	A2	scale	5:1
tolerance std	ASME Y14.5	eng	Sky Chen	2013/10/25	chr	-	ecn no	ELX-DG-16088-1	rel level	Released
surface	✓	appr	Pei-Ming Zheng	2013/10/27	product family	InfinX	cat. no	10120300	rev	C
ASME Y14.5	linear	0.X	±0.3	0.XX	±0.10	0.XXX	±0.05	angular	0°	±2°
		www.fci.com		title		RECEPTACLE ASSEMBLY, 4-PAIR		INFINX		Product - Customer Drw

PDS: Rev :C

STATUS:Released

Printed: Oct 28, 2013

Copyright FCI. FCI

A  
B  
C  
D  
E  
F

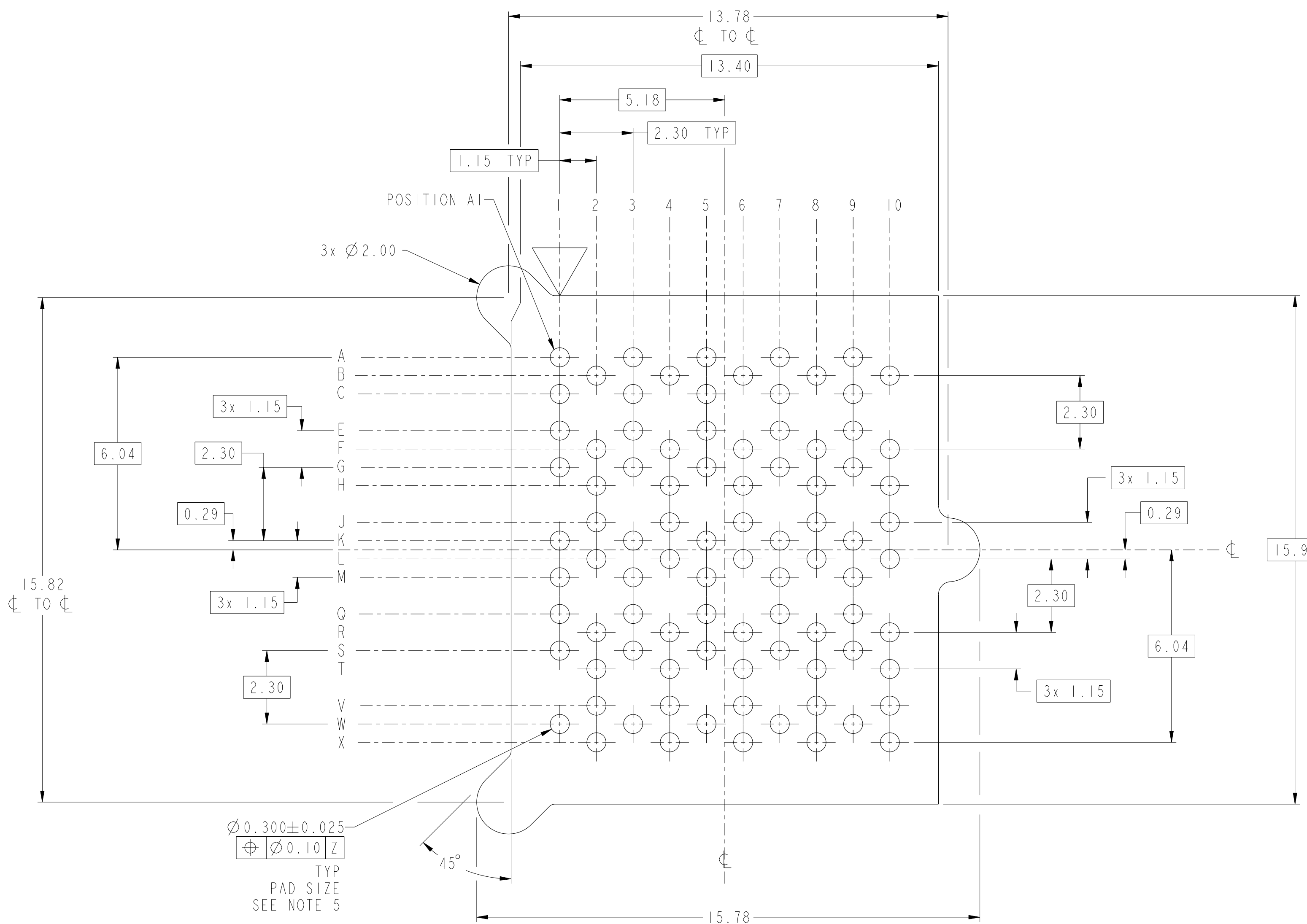

Z

**BOARD LAYOUT 5 IMLA CONNECTOR**  
**SEE NOTE 4**  
**SCALE 10:1**

$\varnothing 0.300 \pm 0.025$   
 $\varnothing 0.10$  Z  
 TYP  
 PAD SIZE  
 SEE NOTE 5

spec ref	-	dr	Mark Lauermann	2012/07/02	projection	MM	size	A2	scale	5:1							
tolerance std	ASME Y14.5	eng	Sky Chen	2013/10/25			ecn no	ELX-DG-16088-1	rel level	Released							
TOLERANCES UNLESS OTHERWISE SPECIFIED		chr	-														
surface	<table border="1"> <tr> <td>linear</td> <td>0.X</td> <td>±0.3</td> </tr> <tr> <td></td> <td>0.XX</td> <td>±0.10</td> </tr> <tr> <td></td> <td>0.XXX</td> <td>±0.05</td> </tr> </table>	linear	0.X	±0.3								0.XX	±0.10		0.XXX	±0.05	apppr
linear	0.X	±0.3															
	0.XX	±0.10															
	0.XXX	±0.05															
ASME Y14.5	angular	0°	±2°	www.fci.com	cat. no.	Product - Customer Drw	sheet 2 of 4										
				<b>RECEPTACLE ASSEMBLY, 4-PAIR</b> INFNIX		dwg no 10120300	rev <b>C</b>										

PDS: Rev :C



STATUS:Released

Printed: Oct 28, 2013

Copyright FCI.



CURRENTLY TOOLED AND AVAILABLE PART NUMBERS

PART NUMBER	HEIGHT	COLUMNS	DAMPER	Ω	RoHS	DIM "H"	DIM "L"	PLATING SPEC.
10120300-110-102LF	9mm	5	NO	85	YES	8.90	13.40	 0.76um(30u") MIN Au with lube
10120300-111-102LF	9mm	5	YES	85	YES	8.90	13.40	
10120300-130-102LF	9mm	15	NO	85	YES	8.90	36.40	
10120300-131-102LF	9mm	15	YES	85	YES	8.90	36.40	
10120300-110-202LF	9mm	5	NO	85	YES	8.90	13.40	 0.76um(30u") MIN GXT
10120300-111-202LF	9mm	5	YES	85	YES	8.90	13.40	
10120300-130-202LF	9mm	15	NO	85	YES	8.90	36.40	
10120300-131-202LF	9mm	15	YES	85	YES	8.90	36.40	

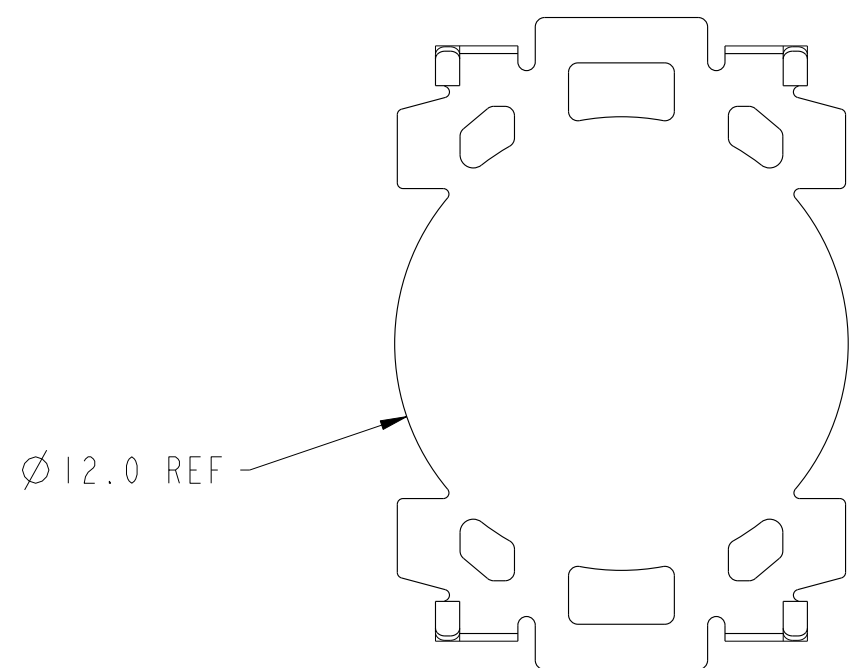

FLAT AREA PICK-UP CAP

NOTES:

- MATERIAL:  
HOUSING/WAFERS: HIGH TEMPERATURE THERMOPLASTIC (LCP)  
VACUUM CAP: STAINLESS STEEL  
CONTACTS: COPPER ALLOY  
PLATING (CONTACT): GOLD OR GXT, CAPABLE OF MEETING THE REQUIREMENTS OF FCI PRODUCT SPECIFICATION GS-12-1061  
SOLDER BALL: (SEE TABLE) LEADFREE 95.5 Sn/4Ag/0.5Cu
- SOLDER SPHERES WILL NOT BE A PERFECT SPHERICAL SHAPE DUE TO REFLOW ATTACHMENT,
- PRODUCT SPECIFICATION: GS-12-1061  
APPLICATION SPECIFICATION: GS-20-0365
- THE SEATING PLANE (DATUM "S") IS THE SURFACE ON WHICH THE THREE LOWEST SOLDER BALLS WOULD REST. COPLANARITY IS THE MEASUREMENT OF THE OTHER SOLDER BALL APICES TO THIS SURFACE. THE APICES OF ALL BALLS MUST BE WITHIN THE SPECIFIED LIMITS.
- SPECIFIED POSITIONAL TOLERANCE DEFINES PAD TO PAD LOCATION WITHIN LAND PATTERN. POSITION TOLERANCE OF LAND PATTERN TO FUDICIAL MARKS OR PCB DATUMS SHALL BE DEFINED BY CUSTOMER.
- THIS PRODUCT PART NUMBER LF MEETS THE REQUIREMENTS OF THE EUROPEAN UNION DIRECTIVE OF RESTRICTIONS FOR HAZARDOUS SUBSTANCES (DIRECTIVE 2002/95/EC) AS DESCRIBED IN GS-47-0004.
- SEE TABLE ON SHEET 3 FOR AVAILABLE PART NUMBERS

P/N CODE FORMAT: **10120300 - 111 - 101 LF**

**STACK HEIGHT**  
1=9mm HIGH  
2=24.5mm HIGH

**NUMBER OF IMLAs**  
1=5 IMLAs  
2=9 IMLAs  
3=15 IMLAs

**RESONANCE DAMPER**  
0=NO  
1=YES

**RoHS COMPLIANCE**  
--=NO  
LF=YES



**IMPEDANCE**  
1=100Ω  
2=85Ω

**NOT USED**

**PLATING**  
 1=Au  
2=GXT

- PACKAGED IN TRAYS.
- THE HOUSING WILL WITHSTAND EXPOSURE TO 260 °C PEAK TEMPERATURE FOR 40 SECONDS IN A CONVECTION, INFRA-RED OR VAPOR PHASE REFLOW OVEN.
- A  SYMBOL WILL BE NEXT TO ANY DIMENSION, VIEW, OR NOTE WHICH HAS BEEN MODIFIED WITH THE CURRENT DRAWING REVISION.

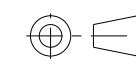
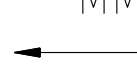
Copyright FCI.

spec ref	-	dr	Mark Lauermann	2012/07/02	projection	MM	size	A2	scale	5:1											
tolerance std	ASME Y14.5	eng	Sky Chen	2013/10/25			ecn no	ELX-DG-16088-1	rel level	Released											
TOLERANCES UNLESS OTHERWISE SPECIFIED		chr	-	apppr							Pei-Ming Zheng	2013/10/27	product family	InfinX							
surface	<table border="1"> <tr> <td>linear</td> <td>0.X</td> <td>±0.3</td> </tr> <tr> <td></td> <td>0.XX</td> <td>±0.10</td> </tr> <tr> <td></td> <td>0.XXX</td> <td>±0.05</td> </tr> <tr> <td>angular</td> <td>0°</td> <td>±2°</td> </tr> </table>	linear	0.X	±0.3								0.XX	±0.10		0.XXX	±0.05	angular	0°	±2°		
linear	0.X	±0.3																			
	0.XX	±0.10																			
	0.XXX	±0.05																			
angular	0°	±2°																			
ASME Y14.5	www.fci.com	cat. no.	Product - Customer Drw		sheet 4 of 4																