

TABLE OF CONTENTS	
SHEET NO.	SHEET DESCRIPTION
1	NOTES AND BOM
2	CONFIGURATIONS
3-4	KEY CONFIGURATIONS
5	BLADE SEALED ASSEMBLY
6	SYSTEM PACKAGING
7	BACKSHELL NOTES
8	BACKSHELL
9	BACKSHELL CONFIGURATIONS

NOTES: VALID UNLESS OTHERWISE SPECIFIED

1. GENERAL:

a. APPLICATION SPECIFICATION SEE: AS-33472-100
 -CONTAINS: PRODUCT INTRODUCTION, PRODUCT SUMMARY, CONNECTOR ASSEMBLY, PACKAGING INFORMATION, CONNECTOR MATING, SERVICE INSTRUCTIONS, ELECTRICAL CONTINUITY CHECKING, CRIMPING, AND TROUBLESHOOTING.
 -DESIGNED TO MATE WITH RECEPTACLE SEALED ASSEMBLY AS SPECIFIED IN THE MATING CONNECTOR DRAWINGS CHART.
 +DENOTES DRAWINGS THAT CAN BE ACCESSED AT <http://ewcap.uscarteams.org/>.
 -ASSEMBLY SHIPPED WITH PLR IN PRE-LOCK POSITION (SEE PLR PRE-LOCK VIEW SHEET 5).

MATING CONNECTOR DRAWINGS	
DESCRIPTION	MOLEX INLINE
2X2	SD-33472-0001
2X3	SD-33472-0001
2X4	SD-33472-0001
2X6	SD-33472-0001
2X8	SD-33472-0001
2X10	SD-33472-0001

b. PRODUCT SPECIFICATION SEE:
 -STANDARD CONFIGURATION: PS-33472-000
 -UL V0 CONFIGURATION: TBD
 CONTAINS: PRODUCT INTRODUCTION, PRODUCT SUMMARY, RATINGS (CURRENT, TEMPERATURE, SEALING, AND FLAMMABILITY), TERMINALS, WIRE DIAMETER RANGE, PRODUCT VALIDATION, AND PRODUCT DEVIATIONS.

c. PACKAGING SPECIFICATION PER MOLEX DRAWING: PK-31300-635

d. PARTS MUST BE IN COMPLIANCE TO MOLEX CHEMICAL SUBSTANCES FOR PRODUCTS AND PACKAGING SPECIFICATION: QEHS-699000-300

e. DATA MUST BE SUBMITTED UNDER THE MOLEX PART NUMBER TO IMS (COMPANY ID#13255)

2. DESIGN - MATERIALS:

a. FOR BILL OF MATERIALS SEE:
 -STANDARD CONFIGURATION: SD-33482-0002
 -UL V0 CONFIGURATION: SD-160084-0002

3. DESIGN - GEOMETRY:

a. THE 3-D CAD DATA IS BASIC (WITHOUT TOLERANCE) AND MASTER FOR THIS PART WITH THE EXCEPTION OF UNDERLINED DIMENSIONS. DIMENSIONAL INFORMATION NOT SHOWN ON THIS DRAWING IS DEFINED BY THE DATA FILE AT ITS LATEST REVISION.

b. GEOMETRIC DIMENSIONS AND TOLERANCES PER ASME Y14.5M-2009

c. EDGES AND UNDIMENSIONED DETAILS PER ISO13715

d. CORNERS SHOWN AS SHARP TO BE R 0.2 MAX.

e. LETTERING SHALL BE 0.15 MAX RAISED IN 0.25 MAX RECESS PAD. THIS INCLUDES RECYCLING CODE, CAVITY ID, VENDOR IDENTIFICATION, AND CUSTOMER MATERIAL NUMBER.

f. VISUAL DEFECTS SHALL MEET COSMETIC STANDARD PS-45499-002 (Class B).

g. LASER MARKING:
 1. PART NUMBER
 2. DAY OF THE YEAR
 3. SHIFT
 4. YEAR

FOR ADDITIONAL INFORMATION SEE SECTION 5 UNDER PROCEDURES IN ES-34735-008.

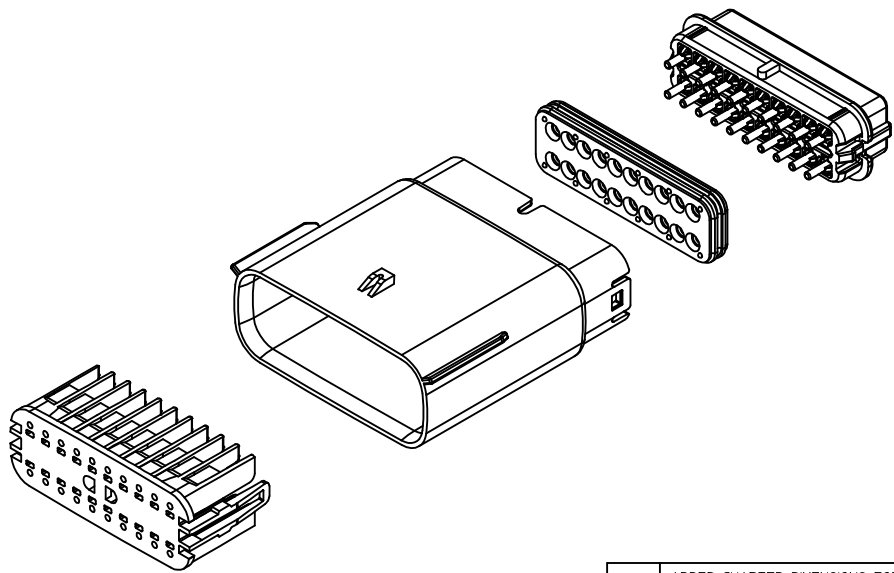
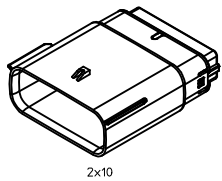
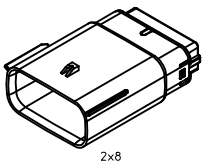
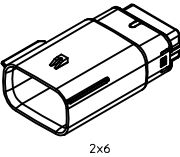
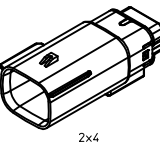
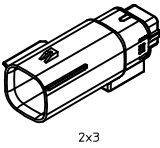
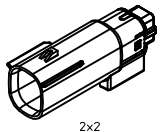

E	ADDED CHARTED DIMENSIONS FOR 2X2, 2X4, 2X6 AND 2X8 WITH CLIP/SLOT
D	MINOR GEOMETRY CHANGE FOR UL V0
C3	ADD 2X4
C2	ADD 2X3
C1	ADD UL V0 CONFIGURATIONS
C	ADD 2X8
B1	ADD 2X6 BACKSHELL INFO
B	ADD 2X6
A	INITIAL RELEASE
REV	REV DESCRIPTION

INSPECTION NUMBER LOG	
LAST NUMBER:	9
ADDED:	
REMOVED:	

ENTER DESCRIPTION EC NO: UAUZ017-0031 DRWING: 104 CHYD: APPR: KOKOSKI 2016/08/16 2016/09/01	DIMENSION STYLE MM ONLY	SCALE 1.5:1	DESIGN UNITS METRIC	THIRD ANGLE PROJECTION	
	QUALITY SYMBOLS ▽=0 ▽=0 ▽=0	GENERAL TOLERANCES (UNLESS SPECIFIED) 4 PLACES ± --- ± --- 3 PLACES ± --- ± --- 2 PLACES ± 0.10 ± --- 1 PLACE ± 0.2 ± --- 0 PLACE ± --- ± ---	DRAWN BY DATE APROFFITT 2014/04/28 CHECKED BY DATE KBORUSZEWSKI 2014/04/29 APPROVED BY DATE VKOSHY 2014/05/14	TITLE MX150 BLADE DUAL ROW SEALED ASSEMBLY MAT SEAL molex	
	ANGULAR ± 1° DRAFT WHERE APPLICABLE MUST REMAIN WITHIN DIMENSIONS	MATERIAL NO. SEE NOTE 2a.	DOCUMENT NO. SD-33482-0001	SHEET NO. 1 OF 9	
	THIS DRAWING CONTAINS INFORMATION THAT IS PROPRIETARY TO MOLEX AND SHOULD NOT BE USED WITHOUT WRITTEN PERMISSION				

SHEET DESCRIPTION

CONFIGURATIONS

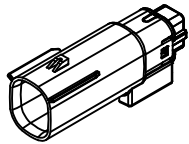

2X2 - STANDARD (STD)

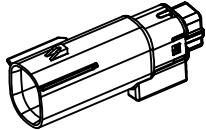

2X2 - UL V0+

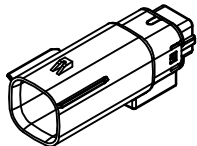

2X3 - STANDARD (STD)

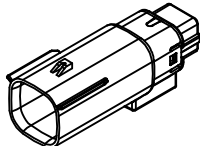

2X3 - LENGTHENED

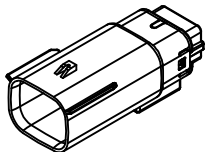

2X4 - STANDARD (STD)

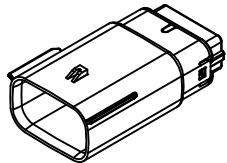

2X6 - STANDARD (STD)

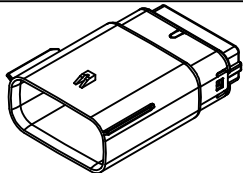

2X8 - STANDARD (STD)

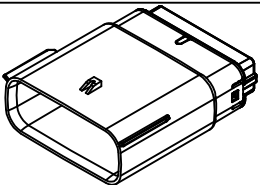

2X10 - STANDARD (STD)

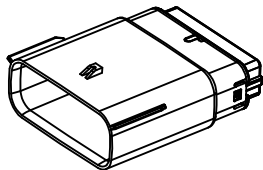

2X10 - UL V0+

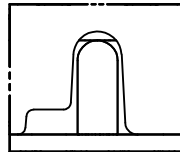

UL V0 UNIQUE FEATURE

Partial1
SCALE 10:1

* MINOR GEOMETRY CHANGE THAN STANDARD CONFIGURATION.
SEE NOTE 2a FOR MORE INFORMATION

ENTER DESCRIPTION EC NO: UAU2017-0031 DRAWING: 104 CHKD: APPR: KDKOSKJ 2016/08/16 2016/09/01	QUALITY SYMBOLS	GENERAL TOLERANCES (UNLESS SPECIFIED)		DIMENSION STYLE		SCALE	DESIGN UNITS	THIRD ANGLE PROJECTION
	▽=0	mm	INCH	MM ONLY		1.5:1	METRIC	<input checked="" type="checkbox"/>
	▽=0	4 PLACES ± --- ± ---	3 PLACES ± --- ± ---	DRAWN BY	DATE	TITLE		
	▽=0	2 PLACES ± 0.10 ± ---	1 PLACE ± 0.2 ± ---	APPROFFITT	2014/04/28	MX150 BLADE DUAL ROW SEALED ASSEMBLY MAT SEAL		
	ANGULAR ± 1 °	DRAFT WHERE APPLICABLE MUST REMAIN WITHIN DIMENSIONS		CHECKED BY	DATE	DOCUMENT NO.		
		SEE NOTE 2a.		APPROVED BY	DATE	SD-33482-0001		
		SEE NOTE 2a.		VKOSHY	2014/05/14	SHEET NO.		
		SEE NOTE 2a.		MATERIAL NO.		2 OF 9		
		SEE NOTE 2a.		SIZE		THIS DRAWING CONTAINS INFORMATION THAT IS PROPRIETARY TO MOLEX INCORPORATED AND SHOULD NOT BE USED WITHOUT WRITTEN PERMISSION		

SHEET DESCRIPTION
KEY CONFIGURATIONS

2X2

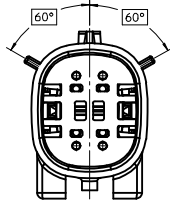

KEY A

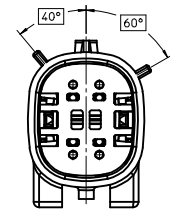

KEY B

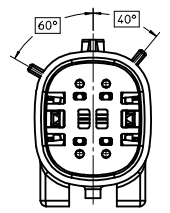

KEY C

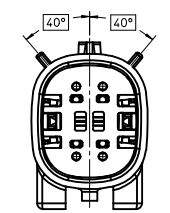

KEY D

2X3

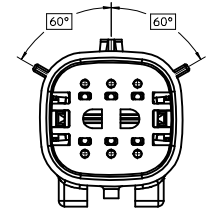

KEY A

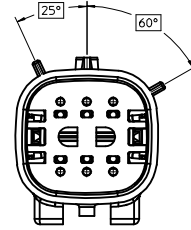

KEY B

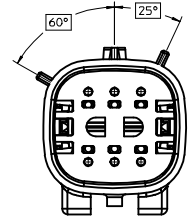

KEY C

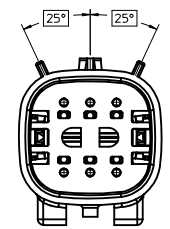

KEY D

2X4

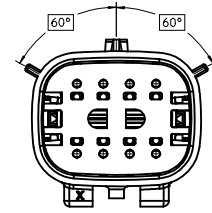

KEY A

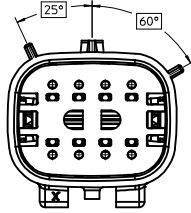

KEY B

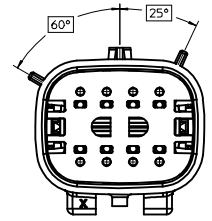

KEY C

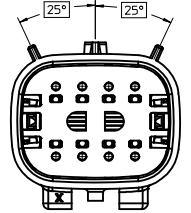

KEY D

ENTER DESCRIPTION EC NO: UAU2017-0031 DRAWING: 104 CHKD: APPR: KCEKOSKI	2016/08/16 2016/09/01	QUALITY SYMBOLS ▽=0 ▽=0 ▽=0	GENERAL TOLERANCES (UNLESS SPECIFIED)		DIMENSION STYLE	SCALE	DESIGN UNITS	THIRD ANGLE PROJECTION		
			mm	INCH	MM ONLY	3:1	METRIC			
			4 PLACES ± --- ± ---		DRAWN BY	DATE	TITLE			
			3 PLACES ± --- ± ---		APPROFF ITT	2014/04/28	MX150 BLADE DUAL ROW SEALED ASSEMBLY MAT SEAL			
2 PLACES ± 0.10 ± ---		CHECKED BY	DATE	molex MATERIAL NO. SEE NOTE 2a. DOCUMENT NO. SD-33482-0001						
1 PLACE ± 0.2 ± ---		KBORUSZEWSKI	2014/04/29							
0 PLACE ± --- ± ---		APPROVED BY	DATE	SHEET NO. 3 OF 9						
		VKOSHY	2014/05/14	THIS DRAWING CONTAINS INFORMATION THAT IS PROPRIETARY TO MOLEX INCORPORATED AND SHOULD NOT BE USED WITHOUT WRITTEN PERMISSION						

SHEET DESCRIPTION
KEY CONFIGURATIONS CONT.

2X6

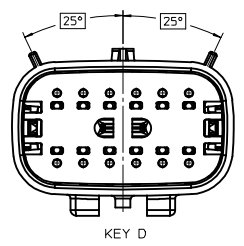
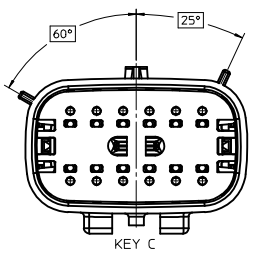
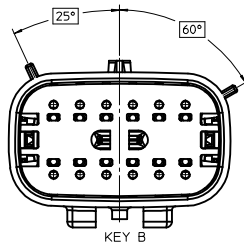
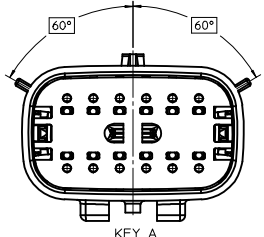

2X8

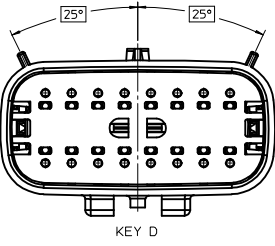
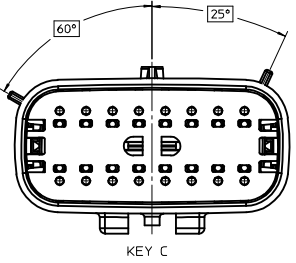
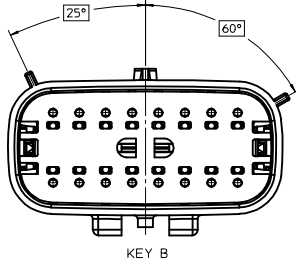
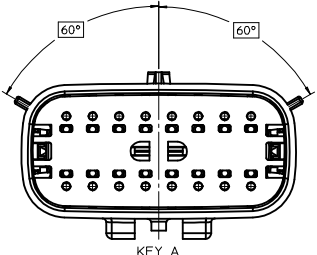

2X10

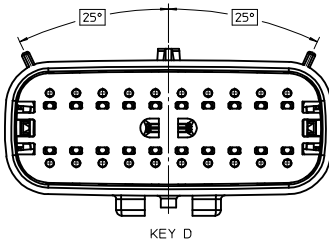
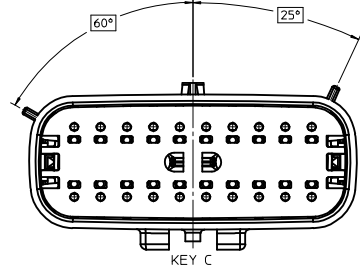
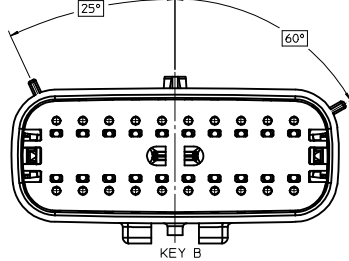
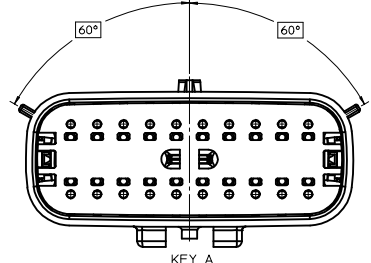

ENTER DESCRIPTION EC NO: UAU2017-0031 DRAWING L04 CHKD: APPR:KDEKOSKI 2016/08/16 2016/09/01	QUALITY SYMBOLS ▽=0 ▽=0 ▽=0	GENERAL TOLERANCES (UNLESS SPECIFIED)		DIMENSION STYLE MM ONLY	SCALE 3:1	DESIGN UNITS METRIC	THIRD ANGLE PROJECTION
		4 PLACES ± --- ± --- 3 PLACES ± --- ± --- 2 PLACES ± 0.10 ± --- 1 PLACE ± 0.2 ± --- 0 PLACE ± --- ± ---	mm INCH ± --- ± --- ± 0.10 ± --- ± 0.2 ± --- ± --- ± ---	DRAWN BY APPROFITT DATE 2014/04/28	CHECKED BY KBORUSZEWSKI DATE 2014/04/29	APPROVED BY VKOSHY DATE 2014/05/14	MATERIAL NO. SEE NOTE 2a.
DRAFT WHERE APPLICABLE MUST REMAIN WITHIN DIMENSIONS		THIS DRAWING CONTAINS INFORMATION THAT IS PROPRIETARY TO MOLEX INCORPORATED AND SHOULD NOT BE USED WITHOUT WRITTEN PERMISSION					

SHEET DESCRIPTION

BLADE SEALED ASSEMBLY

CHARTED DIMENSIONS

DESCRIPTION	DIMENSIONS				
	A	B	C	D	E
2X2	15.54	1.75	24.40	54.45	22.23
2X3 STANDARD	19.04	3.50	26.21	54.45	22.23
2X3 LENGTHENED	19.04	3.50	26.21	56.45	22.23
2X4	22.54	1.75	27.21	54.45	22.23
2X6	29.54	1.75	32.27	54.45	22.23
2X8	36.54	1.75	38.88	54.45	22.23
2X10	43.64	1.75	45.65	54.45	22.05

OPTIONAL LASER MARKING ON THIS SURFACE SEE NOTE 3g.

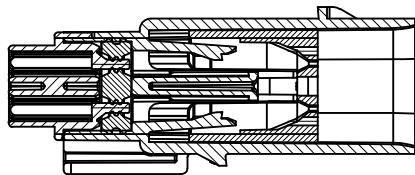
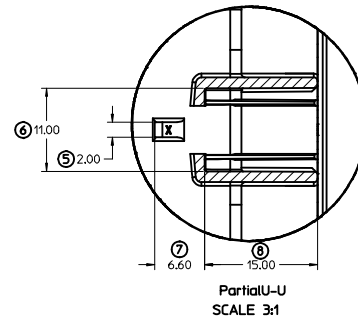
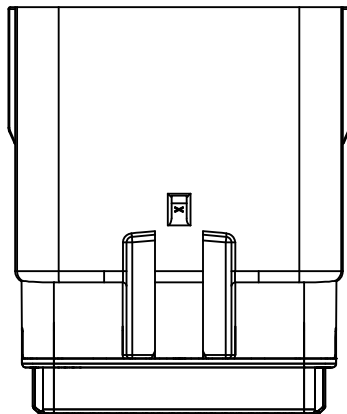
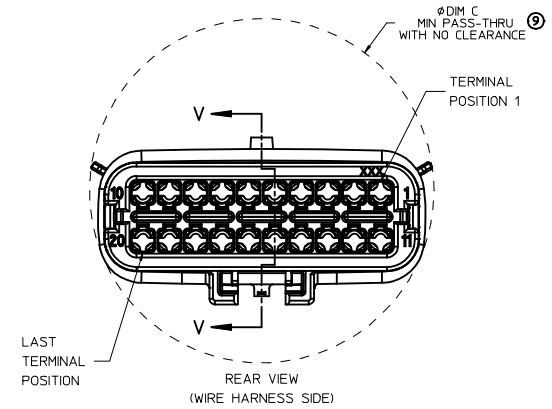
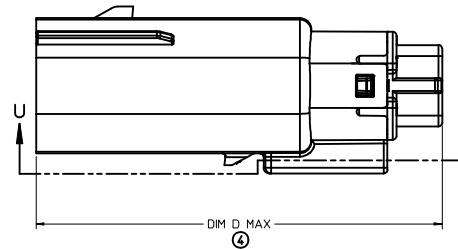
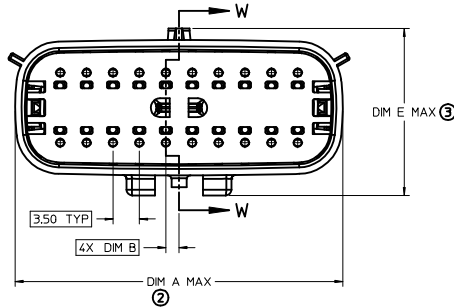
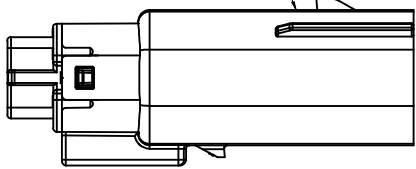

PRIMARY LOCK REINFORCEMENT (PLR) SHOWN IN PRE-STAGED POSITION
SECTION W-W

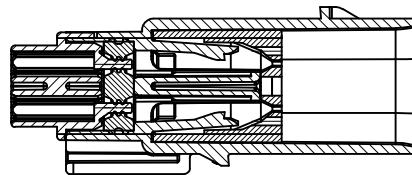

PRIMARY LOCK REINFORCEMENT (PLR) SHOWN IN FINAL-LOCK POSITION
SECTION V-V

ENTER DESCRIPTION IEC NO: UAU2017-0031 DRWINGL/04 CHKD: APPR:KOEKOSKI	2016/08/16 2016/09/01	QUALITY SYMBOLS ∇=0 ∇=0.10 ∇=0.2	GENERAL TOLERANCES (UNLESS SPECIFIED)		DIMENSION STYLE MM ONLY	SCALE 3:1	DESIGN UNITS METRIC	THIRD ANGLE PROJECTION	
			m/m	INCH					
			4 PLACES ± --- ± --- 3 PLACES ± --- ± --- 2 PLACES ± 0.10 ± --- 1 PLACE ± 0.2 ± --- 0 PLACE ± --- ± ---						
			ANGULAR ± 1 ° DRAFT WHERE APPLICABLE MUST REMAIN WITHIN DIMENSIONS						
DRAWN BY DATE APROFF/ITT 2014/04/28 CHECKED BY DATE KBORUSZEWSKI 2014/04/29 APPROVED BY DATE VKOSHY 2014/05/14					MATERIAL NO. SEE NOTE 2a.		DOCUMENT NO. SD-33482-0001		SHEET NO. 5 OF 9
THIS DRAWING CONTAINS INFORMATION THAT IS PROPRIETARY TO MOLEX INCORPORATED AND SHOULD NOT BE USED WITHOUT WRITTEN PERMISSION									

SHEET DESCRIPTION

SYSTEM PACKAGING

CHARTED DIMENSIONS

CKT	BLADE CONFIGURATION	RECEPTACLE CONFIGURATION	DIMENSIONS	
			K	L
2X2	STANDARD	W/O CLIPSLOT	72.78	28.00
		W/ CLIPSLOT	72.78	28.50
		LENGTHENED	77.21	28.00
2X3	STANDARD	W/O CLIPSLOT	72.78	28.00
		W/ CLIPSLOT	72.78	30.50
		LENGTHENED	74.79	28.00
2X4	STANDARD	W/O CLIPSLOT	72.78	29.50
		W/ CLIPSLOT	72.78	31.50
2X6	STANDARD	W/O CLIPSLOT	72.79	35.58
		W/ CLIPSLOT	72.79	35.58
2X8	STANDARD	W/O CLIPSLOT	72.67	42.25
		W/ CLIPSLOT	72.67	42.25
2X10	STANDARD	STANDARD	72.78	49.05

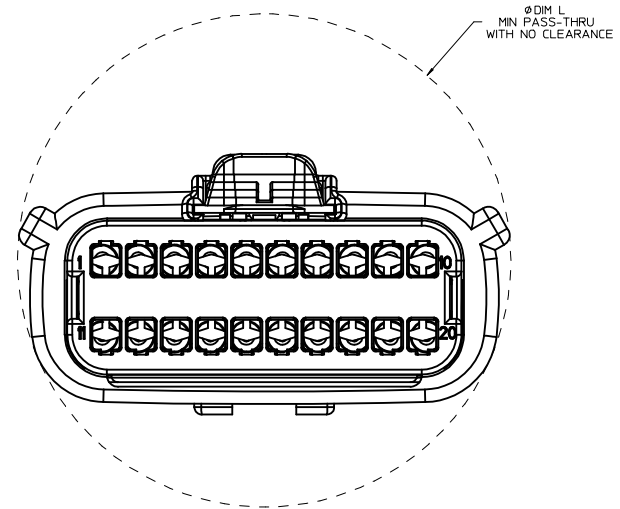
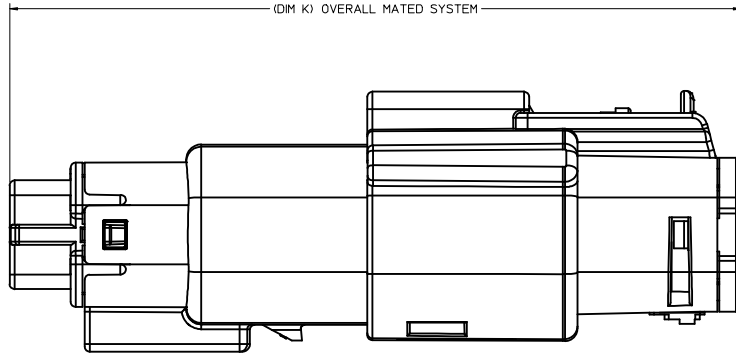

ENTER DESCRIPTION EC NO: UA02017-0031 DRAWING: 104 CHKD: APPR:KDEKOSKI 2016/08/16 2016/09/01	QUALITY SYMBOLS ∇=0 ∇=0 ∇=0 ∇=0	GENERAL TOLERANCES (UNLESS SPECIFIED) mm INCH 4 PLACES ± --- ± --- 3 PLACES ± --- ± --- 2 PLACES ± 0.10 ± --- 1 PLACE ± 0.2 ± --- 0 PLACE ± --- ± --- ANGULAR ± 1 ° DRAFT WHERE APPLICABLE MUST REMAIN WITHIN DIMENSIONS	DIMENSION STYLE MM ONLY DRAWN BY DATE APPROFFITT 2014/04/28 CHECKED BY DATE KBORUSZEWSKI 2014/04/29 APPROVED BY DATE VKOSHY 2014/05/14 MATERIAL NO. SEE NOTE 2a.	SCALE 4:1 DESIGN UNITS METRIC THIRD ANGLE PROJECTION	TITLE MX150 BLADE DUAL ROW SEALED ASSEMBLY MAT SEAL molex	DOCUMENT NO. SD-33482-0001	SHEET NO. 6 OF 9
	THIS DRAWING CONTAINS INFORMATION THAT IS PROPRIETARY TO MOLEX INCORPORATED AND SHOULD NOT BE USED WITHOUT WRITTEN PERMISSION						
	SIZE 1						
	1						

SHEET DESCRIPTION
BACKSHELL NOTES

BACKSHELL NOTES: VALID UNLESS OTHERWISE SPECIFIED

1. GENERAL:
 a. APPLICATION SPECIFICATION SEE: AS-34951-001
 -DESIGNED TO MATE WITH BLADE SEALED ASSEMBLY SPECIFIED IN MOLEX DRAWING SD-33482-0001.
 -SYSTEM TO BE USED WITH WIRE WITHIN DIAMETER RANGE OF 1.2mm TO 2.69mm.
 -COMPONENTS ARE OPTIONAL AND MUST BE PURCHASED SEPERATELY.
 -BACKSHELL DESIGN IS OWNED BY SCHLEMMER.
 -FOR ADDITIONAL INFORMATION SEE THE BACKSHELL COMPONENT DRAWING SD-34950-0001.

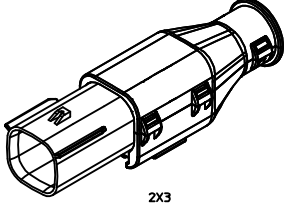

2X3

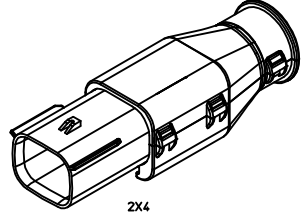

2X4

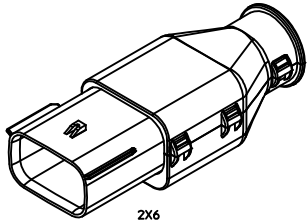

2X6

BACKSHELL CUSTOMER MODEL NUMBER LEGEND

- 34950-XXXX
- CUSTOMER MODEL COMPONENTS
 - 0 - BACKSHELL ONLY
 - 1 - BACKSHELL & MX150 HOUSING KEY A ASSEMBLY
 - 2 - BACKSHELL & MX150 HOUSING KEY B ASSEMBLY
 - 3 - BACKSHELL & MX150 HOUSING KEY C ASSEMBLY
 - 4 - BACKSHELL & MX150 HOUSING KEY D ASSEMBLY
 - BACKSHELL FEATURES
 - 1 - WITH RIBS
 - 2 - WITHOUT RIBS
 - MX150 CIRCUIT SIZE 04, 06, 08, 12, 16, 20

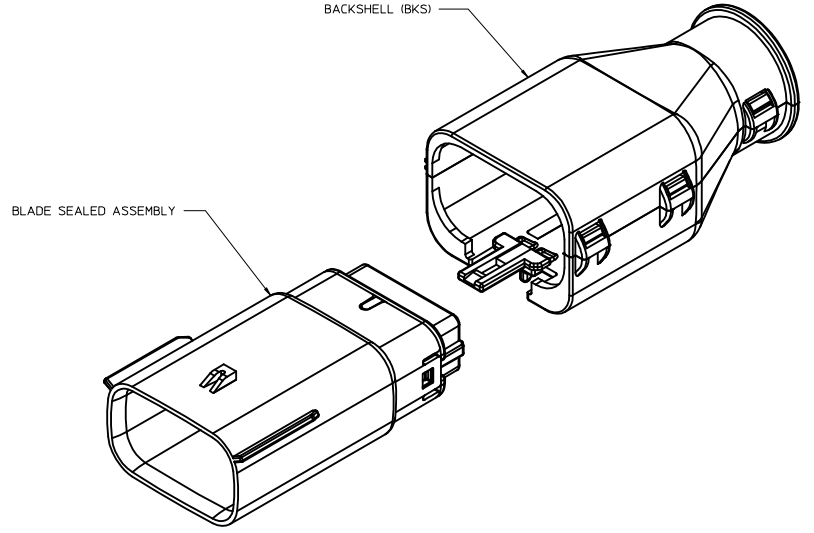

ENTER DESCRIPTION EC NO: UAU2017-0031 CHKD: DRWNG1.04 APPR: KOKOSKI REV:	2016/08/16 2016/09/01 DESCRIPTION	QUALITY SYMBOLS	GENERAL TOLERANCES (UNLESS SPECIFIED)	DIMENSION STYLE MM ONLY	SCALE 4:1	DESIGN UNITS METRIC	THIRD ANGLE PROJECTION
	▽=0	4 PLACES ± --- ± ---	mm INCH	DRAWN BY DATE APPROFIT 2014/04/28	TITLE MX150 BLADE DUAL ROW SEALED ASSEMBLY MAT SEAL		SHEET NO. 7 OF 9
	▽=0	3 PLACES ± --- ± ---	APPROVED BY DATE VKOSHY 2014/05/14	SEE NOTE 2a.	DOCUMENT NO. SD-33482-0001		
	▽=0	2 PLACES ± 0.10 ± ---	DRAFT WHERE APPLICABLE MUST REMAIN WITHIN DIMENSIONS	SIZE A 1	THIS DRAWING CONTAINS INFORMATION THAT IS PROPRIETARY TO MOLEX INCORPORATED AND SHOULD NOT BE USED WITHOUT WRITTEN PERMISSION		
▽=0	1 PLACE ± 0.2 ± ---	0 PLACE ± --- ± ---	ANGULAR ± 1 °				

SHEET DESCRIPTION

BACKSHELL

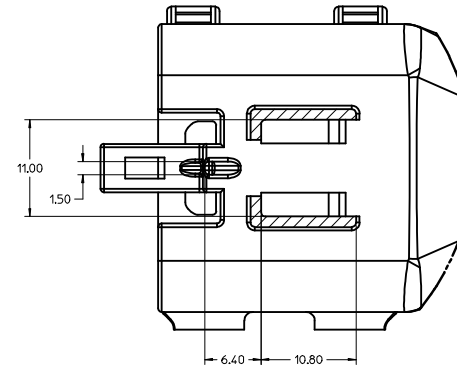
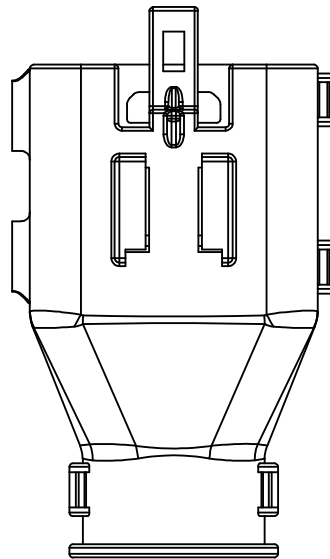
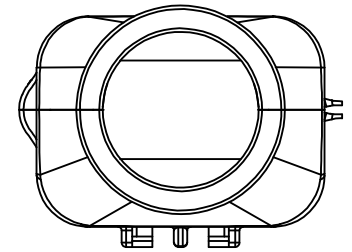
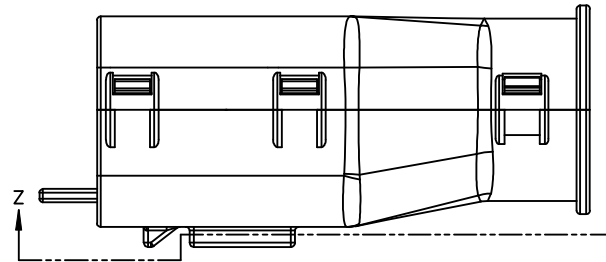
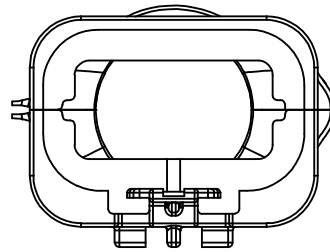
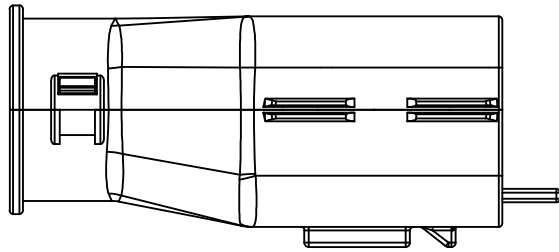

Partial Z-Z
SCALE 35:1

ENTER DESCRIPTION EC NO: UAU2017-0031 DRAWING: 104 CHKD: APPR: KDKOSKI 2016/08/16 2016/09/01	QUALITY SYMBOLS ∇=0 ∇=0 ∇=0	GENERAL TOLERANCES (UNLESS SPECIFIED) mm INCH 4 PLACES ± --- ± --- 3 PLACES ± --- ± --- 2 PLACES ± 0.10 ± --- 1 PLACE ± 0.2 ± --- 0 PLACE ± --- ± ---	DIMENSION STYLE MM ONLY	SCALE 3.5:1	DESIGN UNITS METRIC	THIRD ANGLE PROJECTION	
	DRAWN BY APPROFFITT	DATE 2014/04/28	CHECKED BY KBORUSZEWSKI	DATE 2014/04/29	APPROVED BY VKOSHY	DATE 2014/05/14	MATERIAL NO. SEE NOTE 2a.
	DRAFT WHERE APPLICABLE MUST REMAIN WITHIN DIMENSIONS	ANGULAR ± 1°	DOCUMENT NO. SD-33482-0001	SHEET NO. 8 OF 9	THIS DRAWING CONTAINS INFORMATION THAT IS PROPRIETARY TO MOLEX INCORPORATED AND SHOULD NOT BE USED WITHOUT WRITTEN PERMISSION		
	TITLE MX150 BLADE DUAL ROW SEALED ASSEMBLY MAT SEAL						molex

SHEET DESCRIPTION
BACKSHELL CONFIGURATIONS

CHARTED DIMENSIONS							
CKT	BLADE CONFIGURATION	RECEPTACLE CONFIGURATION	DIMENSIONS				
			M	N	P	R	S
2X3	STANDARD	STANDARD	106.83	32.75	31.75	29.00	29.50
	LENGTHENED	STANDARD	108.71				
2X4	STANDARD	STANDARD	106.83	33.50	31.90	30.70	30.70
2X6	STANDARD	STANDARD	106.83	37.84	37.27	35.83	36.83

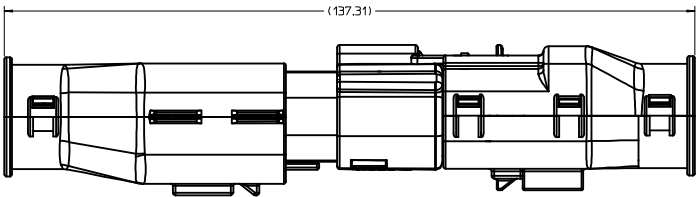

OVERALL MATED SYSTEM WITH BLADE AND RECEPTACLE BACKSHELL

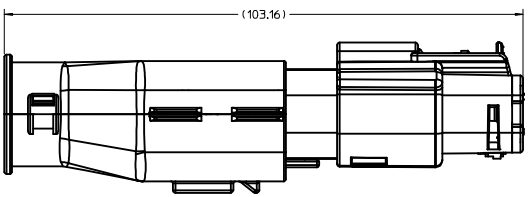
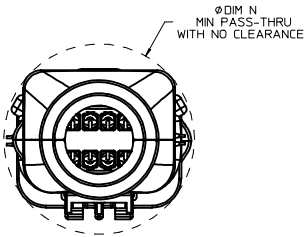

OVERALL MATED SYSTEM WITH BLADE BACKSHELL

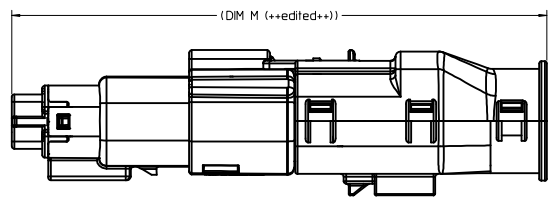
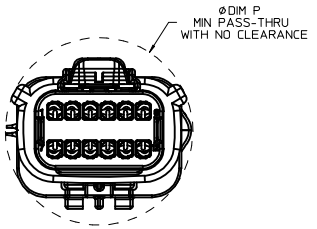

OVERALL MATED SYSTEM WITH RECEPTACLE BACKSHELL

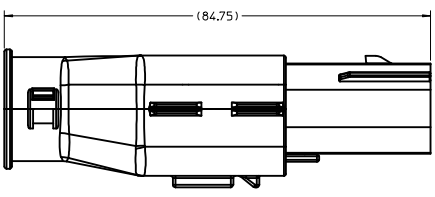
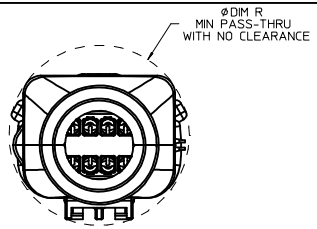

BLADE SEALED ASSEMBLY WITH BLADE BACKSHELL

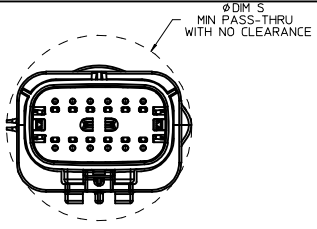

ENTER DESCRIPTION EC NO: UAU2017-0031 DRAWING NO: 2016/08/16 CHKD: APPR:KDKOSKI REV: 2016/09/01	QUALITY SYMBOLS ∇=0 ∇=0 ∇=0	GENERAL TOLERANCES (UNLESS SPECIFIED) mm INCH 4 PLACES ± --- ± --- 3 PLACES ± --- ± --- 2 PLACES ± 0.10 ± --- 1 PLACE ± 0.2 ± --- 0 PLACE ± --- ± --- ANGULAR ± 1 ° DRAFT WHERE APPLICABLE MUST REMAIN WITHIN DIMENSIONS	DIMENSION STYLE MM ONLY	SCALE 2:1	DESIGN UNITS METRIC	THIRD ANGLE PROJECTION	
	DRAWN BY APPROFITT	DATE 2014/04/28	CHECKED BY KBORUSZEWSKI	DATE 2014/04/29	APPROVED BY VKOSHY	DATE 2014/05/14	TITLE MX150 BLADE DUAL ROW SEALED ASSEMBLY MAT SEAL
	MATERIAL NO. SEE NOTE 2a.	DOCUMENT NO. SD-33482-0001	SHEET NO. 9 OF 9	THIS DRAWING CONTAINS INFORMATION THAT IS PROPRIETARY TO MOLEX INCORPORATED AND SHOULD NOT BE USED WITHOUT WRITTEN PERMISSION			
	SIZE 1						

**MX150 2X3 BLADE SEALED ASSEMBLY MAT SEAL
BOM AND PIN OUT SHEET**

ASSEMBLY DESCRIPTION	ASSEMBLY PART NUMBER	COMPONENT				BLOCKED TERMINALS										STATUS	COMMENTS	OPTIONAL ATTACHMENTS SOLD SEPERATELY		
		THE PRESENCE OF AN ABBREVIATION INDICATES THE PRESENCE OF THAT COMPONENT.				CAVITY WITH A NUMBER INDICATES BLOCKED TERMINAL POSITION CAVITY WITHOUT A NUMBER INDICATES OPEN TERMINAL POSITION												BACKSHELL WITH RIBS	BACKSHELL WITHOUT RIBS	
		HOUSING KEY/COLOR	GROMMET CAP	PLR	MAT SEAL	1	2	3	4	5	6									
KEY A, BLACK	33482-3650	A-BLK	GC	PLR	M	1		3		5							SALEABLE		34950-0610	34950-0620
KEY A, BLACK	33482-3651	A-BLK	GC	PLR	M		2		4		6						SALEABLE		34950-0610	34950-0620
KEY A, BLACK	33482-3652	A-BLK	GC	PLR	M	1					6						SALEABLE		34950-0610	34950-0620
KEY A, BLACK	33482-3653	A-BLK	GC	PLR	M		2			5							SALEABLE		34950-0610	34950-0620
KEY A, BLACK	33482-3654	A-BLK	GC	PLR	M	1		3	4								SALEABLE		34950-0610	34950-0620

MX150 2X4 BLADE SEALED ASSEMBLY MAT SEAL
BOM AND PIN OUT SHEET

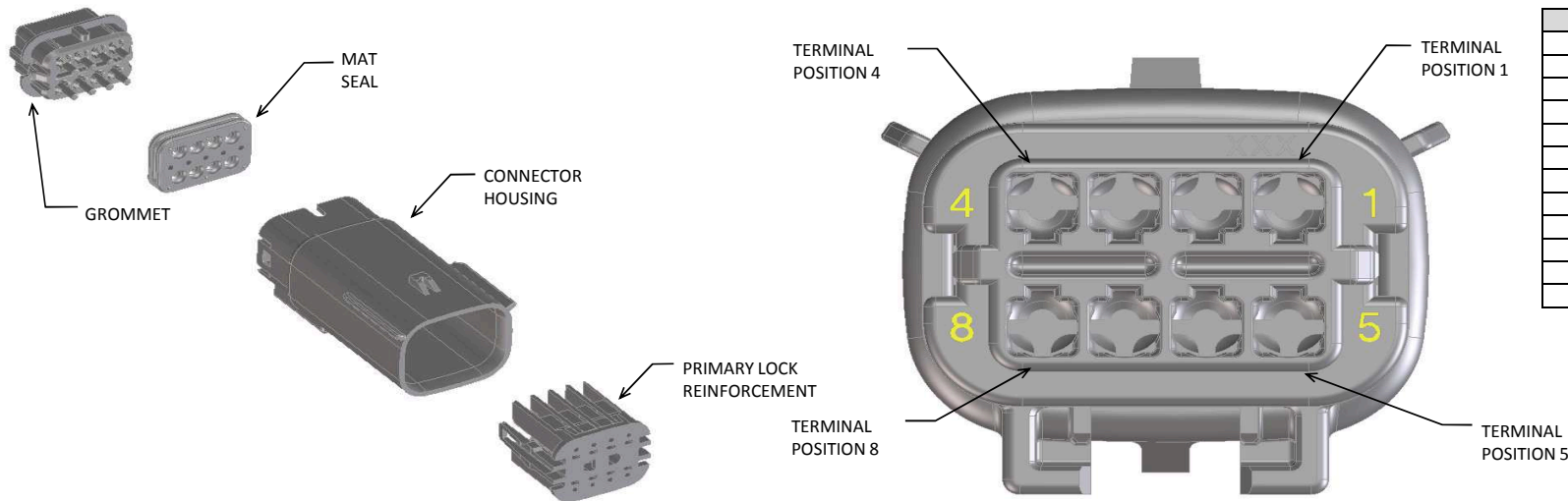

ABBREVIATION	DESCRIPTION	COLOR	MATERIAL
A-BLK	HOUSING, KEYING OPTION A	BLACK	SPS/NYLON GF20
B-LG	HOUSING, KEYING OPTION B	LIGHT GRAY	SPS/NYLON GF20
C-BR	HOUSING, KEYING OPTION C	BROWN	SPS/NYLON GF20
D-GR	HOUSING, KEYING OPTION D	GREEN	SPS/NYLON GF20
C-DG	HOUSING, KEYING OPTION C	DARK GRAY	SPS/NYLON GF20
D-SG	HOUSING, KEYING OPTION D	STONE GRAY	SPS/NYLON GF20
A-YW	HOUSING, KEYING OPTION A	YELLOW	SPS/NYLON GF20
GCP	GROMMET CAP (PLUGGED)	BLACK	SPS/NYLON GF20
GCO	GROMMET CAP (OPEN)	BLACK	SPS/NYLON GF20
PLR	PLR	NATURAL	SPS/NYLON GF20
M-R	MAT SEAL	RUST RED	INHERENTLY LUBRICATED SILICONE
M-B	MAT SEAL	ROYAL BLUE	INHERENTLY LUBRICATED SILICONE

FOR ADDITIONAL INFORMATION SEE SD-33482-0001

ASSEMBLY DESCRIPTION	ASSEMBLY PART NUMBER	COMPONENT				BLOCKED TERMINALS								STATUS	COMMENTS	OPTIONAL ATTACHMENTS SOLD SEPERATELY				
		THE PRESENCE OF AN ABBREVIATION INDICATES THE PRESENCE OF THAT COMPONENT.				CAVITY WITH A NUMBER INDICATES BLOCKED TERMINAL POSITION CAVITY WITHOUT A NUMBER INDICATES OPEN TERMINAL POSITION										BACKSHELL WITH RIBS	BACKSHELL WITHOUT RIBS			
		HOUSING KEY/COLOR	GROMMET CAP	PLR	MAT SEAL	1	2	3	4	5	6	7	8							
KEY A, BLACK	33482-0801	A-BLK	GCO	PLR	M-R											PLANNED OBSOLESCENCE	SEE 33482-4801	DESIGN CONCEPT	DESIGN CONCEPT	
KEY B, LIGHT GRAY	33482-0802	B-LG	GCO	PLR	M-R												PLANNED OBSOLESCENCE	SEE 33482-4802	DESIGN CONCEPT	DESIGN CONCEPT
KEY C, BROWN	33482-0803	C-BR	GCO	PLR	M-R												PLANNED OBSOLESCENCE	SEE 33482-4803	DESIGN CONCEPT	DESIGN CONCEPT
KEY D, GREEN	33482-0804	D-GR	GCO	PLR	M-R												PLANNED OBSOLESCENCE	SEE 33482-4804	DESIGN CONCEPT	DESIGN CONCEPT
VOID KEY	33482-0805																			
KEY A, BLACK	33482-0806	A-BLK	GCP	PLR	M-R				4								PLANNED OBSOLESCENCE	SEE 33482-4806	DESIGN CONCEPT	DESIGN CONCEPT
KEY B, LIGHT GRAY	33482-0807	B-LG	GCP	PLR	M-R				4								PLANNED OBSOLESCENCE	SEE 33482-4807	DESIGN CONCEPT	DESIGN CONCEPT
KEY C, BROWN	33482-0808	C-BR	GCP	PLR	M-R				4								PLANNED OBSOLESCENCE	SEE 33482-4808	DESIGN CONCEPT	DESIGN CONCEPT
KEY D, GREEN	33482-0809	D-GR	GCP	PLR	M-R				4								PLANNED OBSOLESCENCE	SEE 33482-4809	DESIGN CONCEPT	DESIGN CONCEPT
VOID KEY	33482-0810																			
KEY A, BLACK	33482-0811	A-BLK	GCP	PLR	M-R				4	5							PLANNED OBSOLESCENCE	SEE 33482-4811	DESIGN CONCEPT	DESIGN CONCEPT
KEY B, LIGHT GRAY	33482-0812	B-LG	GCP	PLR	M-R				4	5							PLANNED OBSOLESCENCE	SEE 33482-4812	DESIGN CONCEPT	DESIGN CONCEPT
KEY C, BROWN	33482-0813	C-BR	GCP	PLR	M-R				4	5							PLANNED OBSOLESCENCE	SEE 33482-4813	DESIGN CONCEPT	DESIGN CONCEPT
KEY D, GREEN	33482-0814	D-GR	GCP	PLR	M-R				4	5							PLANNED OBSOLESCENCE	SEE 33482-4814	DESIGN CONCEPT	DESIGN CONCEPT
VOID KEY	33482-0815																			
KEY A, BLACK	33482-0816	A-BLK	GCP	PLR	M-R	1			4	5							PLANNED OBSOLESCENCE	SEE 33482-4816	DESIGN CONCEPT	DESIGN CONCEPT
KEY B, LIGHT GRAY	33482-0817	B-LG	GCP	PLR	M-R	1			4	5							PLANNED OBSOLESCENCE	SEE 33482-4817	DESIGN CONCEPT	DESIGN CONCEPT
KEY C, BROWN	33482-0818	C-BR	GCP	PLR	M-R	1			4	5							PLANNED OBSOLESCENCE	SEE 33482-4818	DESIGN CONCEPT	DESIGN CONCEPT
KEY D, GREEN	33482-0819	D-GR	GCP	PLR	M-R	1			4	5							PLANNED OBSOLESCENCE	SEE 33482-4819	DESIGN CONCEPT	DESIGN CONCEPT
VOID KEY	33482-0820																			
KEY A, BLACK	33482-0821	A-BLK	GCP	PLR	M-R	1			4	5				8			PLANNED OBSOLESCENCE	SEE 33482-4821	DESIGN CONCEPT	DESIGN CONCEPT
KEY B, LIGHT GRAY	33482-0822	B-LG	GCP	PLR	M-R	1			4	5				8			PLANNED OBSOLESCENCE	SEE 33482-4822	DESIGN CONCEPT	DESIGN CONCEPT
KEY C, BROWN	33482-0823	C-BR	GCP	PLR	M-R	1			4	5				8			PLANNED OBSOLESCENCE	SEE 33482-4823	DESIGN CONCEPT	DESIGN CONCEPT
KEY D, GREEN	33482-0824	D-GR	GCP	PLR	M-R	1			4	5				8			PLANNED OBSOLESCENCE	SEE 33482-4824	DESIGN CONCEPT	DESIGN CONCEPT
VOID KEY	33482-0825																			
KEY A, BLACK	33482-0826	A-BLK	GCP	PLR	M-R	1	2	3				6	7	8			PLANNED OBSOLESCENCE	SEE 33482-4826	DESIGN CONCEPT	DESIGN CONCEPT
KEY A, BLACK	33482-0827	A-BLK	GCP	PLR	M-R									8			PLANNED OBSOLESCENCE	SEE 33482-4827	DESIGN CONCEPT	DESIGN CONCEPT
KEY A, BLACK	33482-0828	A-BLK	GCP	PLR	M-R			3									PLANNED OBSOLESCENCE	SEE 33482-4828	DESIGN CONCEPT	DESIGN CONCEPT
KEY A, BLACK	33482-0829	A-BLK	GCP	PLR	M-R		2	3	4	5		6	7				PLANNED OBSOLESCENCE	SEE 33482-4829	DESIGN CONCEPT	DESIGN CONCEPT
KEY A, BLACK	33482-0830	A-BLK	GCP	PLR	M-R							6					PLANNED OBSOLESCENCE	SEE 33482-4830	DESIGN CONCEPT	DESIGN CONCEPT
KEY A, BLACK	33482-0831	A-BLK	GCP	PLR	M-R							5	6				PLANNED OBSOLESCENCE	SEE 33482-4831	DESIGN CONCEPT	DESIGN CONCEPT
KEY A, BLACK	33482-0832	A-BLK	GCP	PLR	M-R							5	6	8			PLANNED OBSOLESCENCE	SEE 33482-4832	DESIGN CONCEPT	DESIGN CONCEPT
KEY A, BLACK	33482-0833	A-BLK	GCP	PLR	M-R	1		3				5					PLANNED OBSOLESCENCE	SEE 33482-4833	DESIGN CONCEPT	DESIGN CONCEPT
KEY A, BLACK	33482-0834	A-BLK	GCP	PLR	M-R	1	2	3	4	5		6	7	8			PLANNED OBSOLESCENCE	SEE 33482-4834	DESIGN CONCEPT	DESIGN CONCEPT
KEY A, BLACK	33482-0835	A-BLK	GCP	PLR	M-R								7	8			PLANNED OBSOLESCENCE	SEE 33482-4835	DESIGN CONCEPT	DESIGN CONCEPT
KEY A, BLACK	33482-0836	A-BLK	GCP	PLR	M-R		2	3				6	7	8			PLANNED OBSOLESCENCE	SEE 33482-4836	DESIGN CONCEPT	DESIGN CONCEPT
KEY A, BLACK	33482-0837	A-BLK	GCP	PLR	M-R	1			4								PLANNED OBSOLESCENCE	SEE 33482-4837	DESIGN CONCEPT	DESIGN CONCEPT
KEY A, BLACK	33482-0838	A-BLK	GCP	PLR	M-R		2	3				5	6	7	8		PLANNED OBSOLESCENCE	SEE 33482-4838	DESIGN CONCEPT	DESIGN CONCEPT
KEY B, LIGHT GRAY	33482-0839	B-LG	GCP	PLR	M-R									8			PLANNED OBSOLESCENCE	SEE 33482-4839	DESIGN CONCEPT	DESIGN CONCEPT
KEY A, BLACK	33482-0840	A-BLK	GCP	PLR	M-R		2	3				5	6	7	8		PLANNED OBSOLESCENCE	SEE 33482-4840	DESIGN CONCEPT	DESIGN CONCEPT
KEY A, BLACK	33482-0841	A-BLK	GCP	PLR	M-R							6	7				PLANNED OBSOLESCENCE	SEE 33482-4841	DESIGN CONCEPT	DESIGN CONCEPT
KEY A, BLACK	33482-0842	A-BLK	GCP	PLR	M-R								7				PLANNED OBSOLESCENCE	SEE 33482-4842	DESIGN CONCEPT	DESIGN CONCEPT
KEY A, BLACK	33482-0843	A-BLK	GCP	PLR	M-R				4					7			PLANNED OBSOLESCENCE	SEE 33482-4843	DESIGN CONCEPT	DESIGN CONCEPT
KEY A, BLACK	33482-0844	A-BLK	GCP	PLR	M-R			3				6					PLANNED OBSOLESCENCE	SEE 33482-4844	DESIGN CONCEPT	DESIGN CONCEPT
KEY A, BLACK	33482-0845	A-BLK	GCP	PLR	M-R		2	3	4	5		6					PLANNED OBSOLESCENCE	SEE 33482-4845	DESIGN CONCEPT	DESIGN CONCEPT
KEY A, BLACK	33482-0846	A-BLK	GCP	PLR	M-R				4	5			7	8			PLANNED OBSOLESCENCE	SEE 33482-4846	DESIGN CONCEPT	DESIGN CONCEPT
KEY B, LIGHT GRAY	33482-0847	B-LG	GCP	PLR	M-R	1	2	3	4	5		6	7	8			PLANNED OBSOLESCENCE	SEE 33482-4847	DESIGN CONCEPT	DESIGN CONCEPT
KEY A, BLACK	33482-0848	A-BLK	GCP	PLR	M-R	1				5							PLANNED OBSOLESCENCE	SEE 33482-4848	DESIGN CONCEPT	DESIGN CONCEPT

MX150 2X4 BLADE SEALED ASSEMBLY MAT SEAL
BOM AND PIN OUT SHEET

ASSEMBLY DESCRIPTION	ASSEMBLY PART NUMBER	COMPONENT				BLOCKED TERMINALS								STATUS	COMMENTS	OPTIONAL ATTACHMENTS SOLD SEPERATELY		
		THE PRESENCE OF AN ABBREVIATION INDICATES THE PRESENCE OF THAT COMPONENT.				CAVITY WITH A NUMBER INDICATES BLOCKED TERMINAL POSITION CAVITY WITHOUT A NUMBER INDICATES OPEN TERMINAL POSITION										BACKSHELL WITH RIBS	BACKSHELL WITHOUT RIBS	
		HOUSING KEY/COLOR	GROMMET CAP	PLR	MAT SEAL	1	2	3	4	5	6	7	8					
KEY A, BLACK	33482-4836	A-BLK	GCP	PLR	M-B		2	3		6	7	8			SALEABLE		DESIGN CONCEPT	DESIGN CONCEPT
KEY A, BLACK	33482-4837	A-BLK	GCP	PLR	M-B	1			4						SALEABLE		DESIGN CONCEPT	DESIGN CONCEPT
KEY A, BLACK	33482-4838	A-BLK	GCP	PLR	M-B		2	3		5	6	7	8		SALEABLE		DESIGN CONCEPT	DESIGN CONCEPT
KEY B, LIGHT GRAY	33482-4839	B-LG	GCP	PLR	M-B							8			SALEABLE		DESIGN CONCEPT	DESIGN CONCEPT
KEY A, BLACK	33482-4840	A-BLK	GCP	PLR	M-B		2	3		5	6		8		SALEABLE		DESIGN CONCEPT	DESIGN CONCEPT
KEY A, BLACK	33482-4841	A-BLK	GCP	PLR	M-B						6	7			SALEABLE		DESIGN CONCEPT	DESIGN CONCEPT
KEY A, BLACK	33482-4842	A-BLK	GCP	PLR	M-B							7			SALEABLE		DESIGN CONCEPT	DESIGN CONCEPT
KEY A, BLACK	33482-4843	A-BLK	GCP	PLR	M-B				4			7			SALEABLE		DESIGN CONCEPT	DESIGN CONCEPT
KEY A, BLACK	33482-4844	A-BLK	GCP	PLR	M-B			3			6				SALEABLE		DESIGN CONCEPT	DESIGN CONCEPT
KEY A, BLACK	33482-4845	A-BLK	GCP	PLR	M-B		2	3	4	5	6				SALEABLE		DESIGN CONCEPT	DESIGN CONCEPT
KEY A, BLACK	33482-4846	A-BLK	GCP	PLR	M-B				4	5		7	8		SALEABLE		DESIGN CONCEPT	DESIGN CONCEPT
KEY B, LIGHT GRAY	33482-4847	B-LG	GCP	PLR	M-B	1	2	3	4	5	6	7	8		SALEABLE		DESIGN CONCEPT	DESIGN CONCEPT
KEY A, BLACK	33482-4848	A-BLK	GCP	PLR	M-B	1				5					SALEABLE		DESIGN CONCEPT	DESIGN CONCEPT
KEY B, LIGHT GRAY	33482-4849	B-LG	GCP	PLR	M-B	1					6				SALEABLE		DESIGN CONCEPT	DESIGN CONCEPT
KEY A, YELLOW	33482-4850	A-YW	GCP	PLR	M-B	1			4						SALEABLE		DESIGN CONCEPT	DESIGN CONCEPT
KEY A, YELLOW	33482-4851	A-YW	GCO	PLR	M-B										SALEABLE		DESIGN CONCEPT	DESIGN CONCEPT
KEY C, DARK GRAY	33482-4852	C-DG	GCO	PLR	M-B										SALEABLE		DESIGN CONCEPT	DESIGN CONCEPT
KEY D, STONE GRAY	33482-4853	D-SG	GCO	PLR	M-B										SALEABLE		DESIGN CONCEPT	DESIGN CONCEPT
KEY A, BLACK	33482-4854	A-BLK	GCP	PLR	M-B	1	2	3	4						SALEABLE		DESIGN CONCEPT	DESIGN CONCEPT
KEY A, BLACK	33482-4855	A-BLK	GCP	PLR	M-B	1	2			5	6	7	8		SALEABLE		DESIGN CONCEPT	DESIGN CONCEPT
KEY A, BLACK	33482-4856	A-BLK	GCP	PLR	M-B	1	2								SALEABLE		DESIGN CONCEPT	DESIGN CONCEPT
KEY A, BLACK	33482-4857	A-BLK	GCP	PLR	M-B	1	2	3		5					SALEABLE		DESIGN CONCEPT	DESIGN CONCEPT
KEY A, BLACK	33482-4858	A-BLK	GCP	PLR	M-B	1	2	3	4	5			8		SALEABLE		DESIGN CONCEPT	DESIGN CONCEPT
KEY A, BLACK	33482-4859	A-BLK	GCP	PLR	M-B	1		3		5	6	7			SALEABLE		DESIGN CONCEPT	DESIGN CONCEPT
KEY A, BLACK	33482-4860	A-BLK	GCP	PLR	M-B	1	2	3	4	5	6				SALEABLE		DESIGN CONCEPT	DESIGN CONCEPT
KEY A, BLACK	33482-4861	A-BLK	GCP	PLR	M-B	1	2	3		6					SALEABLE		DESIGN CONCEPT	DESIGN CONCEPT
KEY A, BLACK	33482-4862	A-BLK	GCP	PLR	M-B	1				6					SALEABLE		DESIGN CONCEPT	DESIGN CONCEPT
KEY A, BLACK	33482-4863	A-BLK	GCP	PLR	M-B	1				6	7	8			SALEABLE		DESIGN CONCEPT	DESIGN CONCEPT
KEY A, BLACK	33482-4864	A-BLK	GCP	PLR	M-B			3	4	5	6	7	8		SALEABLE		DESIGN CONCEPT	DESIGN CONCEPT
KEY A, BLACK	33482-4865	A-BLK	GCP	PLR	M-B				4			7	8		SALEABLE		DESIGN CONCEPT	DESIGN CONCEPT
KEY A, BLACK	33482-4866	A-BLK	GCP	PLR	M-B				4	5	6	7	8		SALEABLE		DESIGN CONCEPT	DESIGN CONCEPT
KEY A, BLACK	33482-4867	A-BLK	GCP	PLR	M-B		2	3	4		6	7	8		SALEABLE		DESIGN CONCEPT	DESIGN CONCEPT
KEY A, BLACK	33482-4868	A-BLK	GCP	PLR	M-B					5	6	7			SALEABLE		DESIGN CONCEPT	DESIGN CONCEPT
KEY A, BLACK	33482-4869	A-BLK	GCP	PLR	M-B			3	4						SALEABLE		DESIGN CONCEPT	DESIGN CONCEPT
KEY A, BLACK	33482-4870	A-BLK	GCP	PLR	M-B						6	7	8		SALEABLE		DESIGN CONCEPT	DESIGN CONCEPT
KEY B, LIGHT GRAY	33482-4871	B-LG	GCP	PLR	M-B							7	8		SALEABLE		DESIGN CONCEPT	DESIGN CONCEPT
KEY A, BLACK	33482-4872	A-BLK	GCP	PLR	M-B	1							8		SALEABLE		DESIGN CONCEPT	DESIGN CONCEPT
KEY A, BLACK	33482-4873	A-BLK	GCP	PLR	M-B						6		8		SALEABLE		DESIGN CONCEPT	DESIGN CONCEPT
KEY A, BLACK	33482-4874	A-BLK	GCP	PLR	M-B		2			5					SALEABLE		DESIGN CONCEPT	DESIGN CONCEPT
KEY A, BLACK	33482-4875	A-BLK	GCP	PLR	M-B					5					SALEABLE		DESIGN CONCEPT	DESIGN CONCEPT
KEY B, LIGHT GRAY	33482-4876	B-LG	GCP	PLR	M-B	1		3					8		SALEABLE		DESIGN CONCEPT	DESIGN CONCEPT
KEY B, LIGHT GRAY	33482-4877	B-LG	GCP	PLR	M-B			3					8		SALEABLE		DESIGN CONCEPT	DESIGN CONCEPT
KEY B, LIGHT GRAY	33482-4878	B-LG	GCP	PLR	M-B	1									SALEABLE		DESIGN CONCEPT	DESIGN CONCEPT
KEY A, BLACK	33482-4879	A-BLK	GCP	PLR	M-B	1	2	3	4	5		7			SALEABLE		DESIGN CONCEPT	DESIGN CONCEPT
KEY A, BLACK	33482-4880	A-BLK	GCP	PLR	M-B	1									SALEABLE		DESIGN CONCEPT	DESIGN CONCEPT
KEY A, BLACK	33482-4881	A-BLK	GCP	PLR	M-B					5			8		SALEABLE		DESIGN CONCEPT	DESIGN CONCEPT
KEY A, BLACK	33482-4882	A-BLK	GCP	PLR	M-B				4		6				SALEABLE		DESIGN CONCEPT	DESIGN CONCEPT
KEY A, BLACK	33482-4883	A-BLK	GCP	PLR	M-B	1						7			SALEABLE		DESIGN CONCEPT	DESIGN CONCEPT
KEY A, BLACK	33482-4884	A-BLK	GCP	PLR	M-B	1	2	3	4			7			SALEABLE		DESIGN CONCEPT	DESIGN CONCEPT
KEY A, BLACK	33482-4885	A-BLK	GCP	PLR	M-B	1	2			5	6		8		SALEABLE		DESIGN CONCEPT	DESIGN CONCEPT
KEY A, BLACK	33482-4886	A-BLK	GCP	PLR	M-B		2	3					8		SALEABLE		DESIGN CONCEPT	DESIGN CONCEPT
KEY A, BLACK	33482-4887	A-BLK	GCP	PLR	M-B	1		3	4			7	8		SALEABLE		DESIGN CONCEPT	DESIGN CONCEPT
KEY A, BLACK	33482-4888	A-BLK	GCP	PLR	M-B				4	5	6				SALEABLE		DESIGN CONCEPT	DESIGN CONCEPT

MX150 2X6 BLADE SEALED ASSY MAT SEAL
BOM AND PIN OUT SHEET

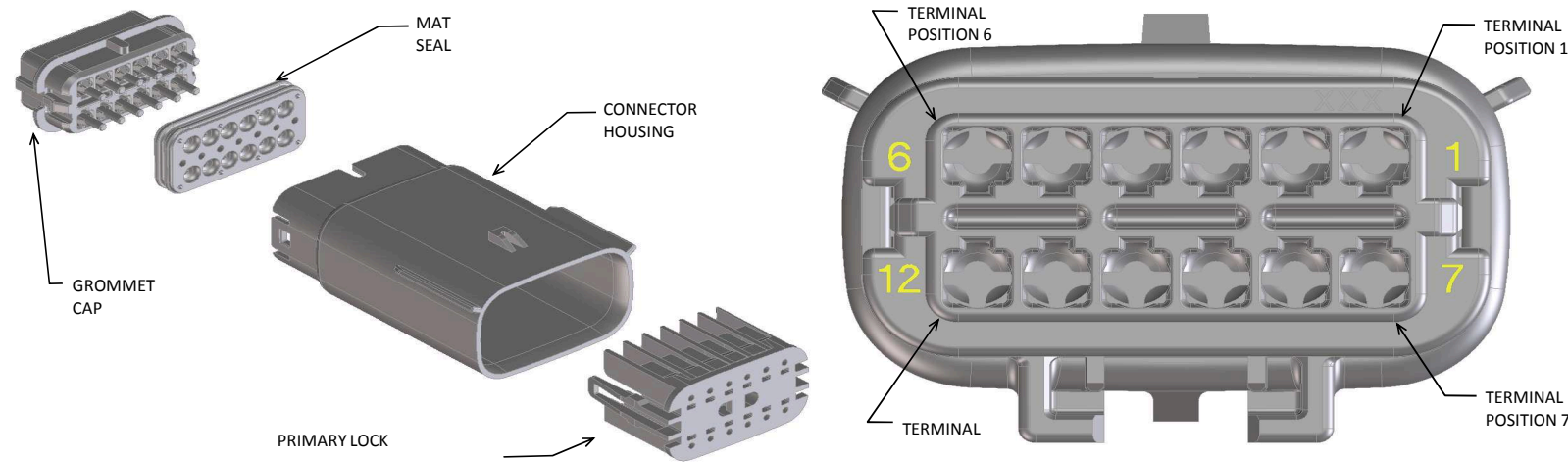

ABBREVIATION	DESCRIPTION	COLOR	MATERIAL
A-BLK	HOUSING, KEYING OPTION A	BLACK	SPS/NYLON GF20
B-LG	HOUSING, KEYING OPTION B	LIGHT GRAY	SPS/NYLON GF20
C-BR	HOUSING, KEYING OPTION C	BROWN	SPS/NYLON GF20
D-GR	HOUSING, KEYING OPTION D	GREEN	SPS/NYLON GF20
A-YL	HOUSING, KEYING OPTION A	YELLOW	SPS/NYLON GF20
C-DG	HOUSING, KEYING OPTION C	DARK GRAY	SPS/NYLON GF20
D-SG	HOUSING, KEYING OPTION D	STONE GRAY	SPS/NYLON GF20
GCP	GROMMET CAP (PLUGGED)	BLACK	SPS/NYLON GF20
PLR	PLR	NATURAL	SPS/NYLON GF20
M-R	MAT SEAL	RUST RED	INHERENTLY LUBRICATED SILICONE
M-B	MAT SEAL	ROYAL BLUE	INHERENTLY LUBRICATED SILICONE

FOR ADDITIONAL INFORMATION SEE SD-33482-0001

ASSEMBLY DESCRIPTION	ASSEMBLY PART NUMBER	COMPONENT				BLOCKED TERMINALS												STATUS	COMMENTS	OPTIONAL ATTACHMENTS SOLD SEPERATELY		
		THE PRESENCE OF AN ABBREVIATION INDICATES THE PRESENCE OF THAT COMPONENT.				CAVITY WITH A NUMBER INDICATES BLOCKED TERMINAL POSITION CAVITY WITHOUT A NUMBER INDICATES OPEN TERMINAL POSITION														BACKSHELL WITH RIBS	BACKSHELL WITHOUT RIBS	
		HOUSING KEY/COLOR	GROMMET CAP	PLR	MAT SEAL	1	2	3	4	5	6	7	8	9	10	11	12					
KEY A, BLACK	33482-1201	A-BLK	GCP	PLR	M-R														PLANNED OBSOLESCENCE	SEE 33482-6201	34950-1210	34950-1220
KEY B, LIGHT GRAY	33482-1202	B-LG	GCP	PLR	M-R														PLANNED OBSOLESCENCE	SEE 33482-6202	34950-1210	34950-1220
KEY C, BROWN	33482-1203	C-BR	GCP	PLR	M-R														PLANNED OBSOLESCENCE	SEE 33482-6203	34950-1210	34950-1220
KEY D, GREEN	33482-1204	D-GR	GCP	PLR	M-R														PLANNED OBSOLESCENCE	SEE 33482-6204	34950-1210	34950-1220
VOID KEY	33482-1205																					
KEY A, BLACK	33482-1206	A-BLK	GCP	PLR	M-R						6								PLANNED OBSOLESCENCE	SEE 33482-6206	34950-1210	34950-1220
KEY B, LIGHT GRAY	33482-1207	B-LG	GCP	PLR	M-R						6								PLANNED OBSOLESCENCE	SEE 33482-6207	34950-1210	34950-1220
KEY C, BROWN	33482-1208	C-BR	GCP	PLR	M-R						6								PLANNED OBSOLESCENCE	SEE 33482-6208	34950-1210	34950-1220
KEY D, GREEN	33482-1209	D-GR	GCP	PLR	M-R						6								PLANNED OBSOLESCENCE	SEE 33482-6209	34950-1210	34950-1220
VOID KEY	33482-1210																					
KEY A, BLACK	33482-1211	A-BLK	GCP	PLR	M-R						6	7							PLANNED OBSOLESCENCE	SEE 33482-6211	34950-1210	34950-1220
KEY B, LIGHT GRAY	33482-1212	B-LG	GCP	PLR	M-R						6	7							PLANNED OBSOLESCENCE	SEE 33482-6212	34950-1210	34950-1220
KEY C, BROWN	33482-1213	C-BR	GCP	PLR	M-R						6	7							PLANNED OBSOLESCENCE	SEE 33482-6213	34950-1210	34950-1220
KEY D, GREEN	33482-1214	D-GR	GCP	PLR	M-R						6	7							PLANNED OBSOLESCENCE	SEE 33482-6214	34950-1210	34950-1220
VOID KEY	33482-1215																					
KEY A, BLACK	33482-1216	A-BLK	GCP	PLR	M-R	1					6	7							PLANNED OBSOLESCENCE	SEE 33482-6216	34950-1210	34950-1220
KEY B, LIGHT GRAY	33482-1217	B-LG	GCP	PLR	M-R	1					6	7							PLANNED OBSOLESCENCE	SEE 33482-6217	34950-1210	34950-1220
KEY C, BROWN	33482-1218	C-BR	GCP	PLR	M-R	1					6	7							PLANNED OBSOLESCENCE	SEE 33482-6218	34950-1210	34950-1220
KEY D, GREEN	33482-1219	D-GR	GCP	PLR	M-R	1					6	7							PLANNED OBSOLESCENCE	SEE 33482-6219	34950-1210	34950-1220
VOID KEY	33482-1220																					
KEY A, BLACK	33482-1221	A-BLK	GCP	PLR	M-R	1					6	7					12		PLANNED OBSOLESCENCE	SEE 33482-6221	34950-1210	34950-1220
KEY B, LIGHT GRAY	33482-1222	B-LG	GCP	PLR	M-R	1					6	7					12		PLANNED OBSOLESCENCE	SEE 33482-6222	34950-1210	34950-1220
KEY C, BROWN	33482-1223	C-BR	GCP	PLR	M-R	1					6	7					12		PLANNED OBSOLESCENCE	SEE 33482-6223	34950-1210	34950-1220
KEY D, GREEN	33482-1224	D-GR	GCP	PLR	M-R	1					6	7					12		PLANNED OBSOLESCENCE	SEE 33482-6224	34950-1210	34950-1220
VOID KEY	33482-1225																					
KEY A, BLACK	33482-1226	A-BLK	GCP	PLR	M-R						6						12		PLANNED OBSOLESCENCE	SEE 33482-6226	34950-1210	34950-1220
KEY A, BLACK	33482-1227	A-BLK	GCP	PLR	M-R	1	2	3	4	5	6	7	8	9	10	11	12		PLANNED OBSOLESCENCE	SEE 33482-6227	34950-1210	34950-1220
KEY B, LIGHT GRAY	33482-1228	B-LG	GCP	PLR	M-R	1	2	3	4	5	6	7	8	9	10	11	12		PLANNED OBSOLESCENCE	SEE 33482-6228	34950-1210	34950-1220
KEY C, BROWN	33482-1229	C-BR	GCP	PLR	M-R	1	2	3	4	5	6	7	8	9	10	11	12		PLANNED OBSOLESCENCE	SEE 33482-6229	34950-1210	34950-1220
KEY D, GREEN	33482-1230	D-GR	GCP	PLR	M-R	1	2	3	4	5	6	7	8	9	10	11	12		PLANNED OBSOLESCENCE	SEE 33482-6230	34950-1210	34950-1220
VOID KEY	33482-1231																					
KEY A, BLACK	33482-1232	A-BLK	GCP	PLR	M-R		2	3					8				11		PLANNED OBSOLESCENCE	SEE 33482-6232	34950-1210	34950-1220
KEY A, BLACK	33482-1233	A-BLK	GCP	PLR	M-R		2	3			5	6	7	8			11		PLANNED OBSOLESCENCE	SEE 33482-6233	34950-1210	34950-1220
KEY A, BLACK	33482-1234	A-BLK	GCP	PLR	M-R						6	7							PLANNED OBSOLESCENCE	SEE 33482-6234	34950-1210	34950-1220
KEY A, BLACK	33482-1235	A-BLK	GCP	PLR	M-R		2	3			6	7	8		10	11			PLANNED OBSOLESCENCE	SEE 33482-6235	34950-1210	34950-1220
KEY B, LIGHT GRAY	33482-1236	B-LG	GCP	PLR	M-R	1					5	6	7	8	9	10			PLANNED OBSOLESCENCE	SEE 33482-6236	34950-1210	34950-1220
KEY A, BLACK	33482-1237	A-BLK	GCP	PLR	M-R														PLANNED OBSOLESCENCE	SEE 33482-6237	34950-1210	34950-1220
KEY B, LIGHT GRAY	33482-1238	B-LG	GCP	PLR	M-R		2							9	10				PLANNED OBSOLESCENCE	SEE 33482-6238	34950-1210	34950-1220
KEY A, BLACK	33482-1239	A-BLK	GCP	PLR	M-R	1					5	6	7	8					PLANNED OBSOLESCENCE	SEE 33482-6239	34950-1210	34950-1220
KEY A, BLACK	33482-1240	A-BLK	GCP	PLR	M-R		2	3					8	9	10	11			PLANNED OBSOLESCENCE	SEE 33482-6240	34950-1210	34950-1220
KEY A, BLACK	33482-1241	A-BLK	GCP	PLR	M-R								7	8	9	10	11		PLANNED OBSOLESCENCE	SEE 33482-6241	34950-1210	34950-1220
KEY A, BLACK	33482-1242	A-BLK	GCP	PLR	M-R								7	8					PLANNED OBSOLESCENCE	SEE 33482-6242	34950-1210	34950-1220
KEY A, BLACK	33482-1243	A-BLK	GCP	PLR	M-R		2							9	10				PLANNED OBSOLESCENCE	SEE 33482-6243	34950-1210	34950-1220
KEY A, BLACK	33482-1244	A-BLK	GCP	PLR	M-R		2			4									PLANNED OBSOLESCENCE	SEE 33482-6244	34950-1210	34950-1220
KEY A, BLACK	33482-1245	A-BLK	GCP	PLR	M-R									9	10	11	12		PLANNED OBSOLESCENCE	SEE 33482-6245	34950-1210	34950-1220
KEY A, BLACK	33482-1246	A-BLK	GCP	PLR	M-R												11		PLANNED OBSOLESCENCE	SEE 33482-6246	34950-1210	34950-1220
KEY A, BLACK	33482-1247	A-BLK	GCP	PLR	M-R		2	3	4				7	8					PLANNED OBSOLESCENCE	SEE 33482-6247	34950-1210	34950-1220
KEY A, BLACK	33482-1248	A-BLK	GCP	PLR	M-R	1			3	4	5	6	7	8					PLANNED OBSOLESCENCE	SEE 33482-6248	34950-1210	34950-1220
KEY A, BLACK	33482-1249	A-BLK	GCP	PLR	M-R										10	11	12		PLANNED OBSOLESCENCE	SEE 33482-6249	34950-1210	34950-1220
KEY A, BLACK	33482-1250	A-BLK	GCP	PLR	M-R					4	5	6	7	8	9				PLANNED OBSOLESCENCE	SEE 33482-6250	34950-1210	34950-1220
KEY A, BLACK	33482-1251	A-BLK	GCP	PLR	M-R		2			4	5				10	11			PLANNED OBSOLESCENCE	SEE 33482-6251	34950-1210	34950-1220
KEY A, BLACK	33482-1252	A-BLK	GCP	PLR	M-R								7						PLANNED OBSOLESCENCE	SEE 33482-6252	34950-1210	34950-1220
KEY A, BLACK	33482-1253	A-BLK	GCP	PLR	M-R		2	3	4	5	6	7	8		10	11	12		PLANNED OBSOLESCENCE	SEE 33482-6253	34950-1210	34950-1220
KEY A, BLACK	33482-1254	A-BLK	GCP	PLR	M-R		2	3	4	5					10	11	12		PLANNED OBSOLESCENCE	SEE 33482-6254	34950-1210	34950-1220

MX150 2X6 BLADE SEALED ASSY MAT SEAL
BOM AND PIN OUT SHEET

ASSEMBLY DESCRIPTION	ASSEMBLY PART NUMBER	COMPONENT				BLOCKED TERMINALS												STATUS	COMMENTS	OPTIONAL ATTACHMENTS SOLD SEPERATELY		
		THE PRESENCE OF AN ABBREVIATION INDICATES THE PRESENCE OF THAT COMPONENT.				CAVITY WITH A NUMBER INDICATES BLOCKED TERMINAL POSITION CAVITY WITHOUT A NUMBER INDICATES OPEN TERMINAL POSITION														BACKSHELL WITH RIBS	BACKSHELL WITHOUT RIBS	
		HOUSING KEY/COLOR	GROMMET CAP	PLR	MAT SEAL	1	2	3	4	5	6	7	8	9	10	11	12					
KEY A, BLACK	33482-1255	A-BLK	GCP	PLR	M-R		2	3	4	5	6	7		9	10	11	12	PLANNED OBSOLESCENCE	SEE 33482-6255	34950-1210	34950-1220	
KEY A, BLACK	33482-1256	A-BLK	GCP	PLR	M-R	1					6	7						PLANNED OBSOLESCENCE	SEE 33482-6256	34950-1210	34950-1220	
KEY A, BLACK	33482-1257	A-BLK	GCP	PLR	M-R									9	10		12	PLANNED OBSOLESCENCE	SEE 33482-6257	34950-1210	34950-1220	
KEY A, BLACK	33482-1258	A-BLK	GCP	PLR	M-R		2	3								11		PLANNED OBSOLESCENCE	SEE 33482-6258	34950-1210	34950-1220	
KEY A, BLACK	33482-1259	A-BLK	GCP	PLR	M-R	1	2	3	4	5				9	10	11	12	PLANNED OBSOLESCENCE	SEE 33482-6259	34950-1210	34950-1220	
KEY A, BLACK	33482-1260	A-BLK	GCP	PLR	M-R											11	12	PLANNED OBSOLESCENCE	SEE 33482-6260	34950-1210	34950-1220	
KEY C, DARK GRAY	33482-1261	C-DG	GCP	PLR	M-R													PLANNED OBSOLESCENCE	SEE 33482-6261	34950-1210	34950-1220	
KEY D, STONE GRAY	33482-1262	D-SG	GCP	PLR	M-R													PLANNED OBSOLESCENCE	SEE 33482-6262	34950-1210	34950-1220	
KEY C, DARK GRAY	33482-1263	C-DG	GCP	PLR	M-R	1	2	3	4	5	6	7	8	9	10	11	12	PLANNED OBSOLESCENCE	SEE 33482-6263	34950-1210	34950-1220	
KEY D, STONE GRAY	33482-1264	D-SG	GCP	PLR	M-R	1	2	3	4	5	6	7	8	9	10	11	12	PLANNED OBSOLESCENCE	SEE 33482-6264	34950-1210	34950-1220	
KEY A, BLACK	33482-1265	A-BLK	GCP	PLR	M-R						6	7	8	9	10	11		PLANNED OBSOLESCENCE	SEE 33482-6265	34950-1210	34950-1220	
KEY A, BLACK	33482-1266	A-BLK	GCP	PLR	M-R	1	2	3	4	5	6	7					12	PLANNED OBSOLESCENCE	SEE 33482-6266	34950-1210	34950-1220	
KEY A, BLACK	33482-1267	A-BLK	GCP	PLR	M-R			3	4	5	6	7						PLANNED OBSOLESCENCE	SEE 33482-6267	34950-1210	34950-1220	
KEY A, BLACK	33482-1268	A-BLK	GCP	PLR	M-R			3	4	5	6	7	8	9	10	11		PLANNED OBSOLESCENCE	SEE 33482-6268	34950-1210	34950-1220	
KEY A, BLACK	33482-1269	A-BLK	GCP	PLR	M-R	1	2	3	4	5			8	9	10	11	12	PLANNED OBSOLESCENCE	SEE 33482-6269	34950-1210	34950-1220	
KEY A, BLACK	33482-1270	A-BLK	GCP	PLR	M-R		2		4				7	8	9	10		PLANNED OBSOLESCENCE	SEE 33482-6270	34950-1210	34950-1220	
KEY A, BLACK	33482-1271	A-BLK	GCP	PLR	M-R		2						7	8	9			PLANNED OBSOLESCENCE	SEE 33482-6271	34950-1210	34950-1220	
KEY A, BLACK	33482-1272	A-BLK	GCP	PLR	M-R		2						7	8	9	10		PLANNED OBSOLESCENCE	SEE 33482-6272	34950-1210	34950-1220	
KEY A, BLACK	33482-1273	A-BLK	GCP	PLR	M-R								8					PLANNED OBSOLESCENCE	SEE 33482-6273	34950-1210	34950-1220	
KEY A, BLACK	33482-1274	A-BLK	GCP	PLR	M-R	1		3	4	5	6		8		10	11	12	PLANNED OBSOLESCENCE	SEE 33482-6274	34950-1210	34950-1220	
KEY A, BLACK	33482-1275	A-BLK	GCP	PLR	M-R				4				8		10			PLANNED OBSOLESCENCE	SEE 33482-6275	34950-1210	34950-1220	
KEY A, BLACK	33482-1276	A-BLK	GCP	PLR	M-R	1	2	3	4		6		8		10	11	12	PLANNED OBSOLESCENCE	SEE 33482-6276	34950-1210	34950-1220	
KEY A, BLACK	33482-1277	A-BLK	GCP	PLR	M-R	1	2	3							11	12		PLANNED OBSOLESCENCE	SEE 33482-6277	34950-1210	34950-1220	
KEY A, BLACK	33482-1278	A-BLK	GCP	PLR	M-R						6					12		PLANNED OBSOLESCENCE	SEE 33482-6278	34950-1210	34950-1220	
KEY A, BLACK	33482-1279	A-BLK	GCP	PLR	M-R	1	2	3	4	5		7	8	9	10	11		PLANNED OBSOLESCENCE	SEE 33482-6279	34950-1210	34950-1220	
KEY A, BLACK	33482-1280	A-BLK	GCP	PLR	M-R	1	2	3	4	5	6			9				PLANNED OBSOLESCENCE	SEE 33482-6280	34950-1210	34950-1220	
KEY A, BLACK	33482-1281	A-BLK	GCP	PLR	M-R		2		4		6		8		10	11		PLANNED OBSOLESCENCE	SEE 33482-6281	34950-1210	34950-1220	
KEY A, BLACK	33482-1282	A-BLK	GCP	PLR	M-R	1	2	3	4	5	6			9	10	11	12	PLANNED OBSOLESCENCE	SEE 33482-6282	34950-1210	34950-1220	
KEY A, BLACK	33482-1283	A-BLK	GCP	PLR	M-R						6			9	10	11	12	PLANNED OBSOLESCENCE	SEE 33482-6283	34950-1210	34950-1220	
KEY A, BLACK	33482-1284	A-BLK	GCP	PLR	M-R	1		3	4	5	6	7	8		10	11	12	PLANNED OBSOLESCENCE	SEE 33482-6284	34950-1210	34950-1220	
KEY D, STONE GRAY	33482-1285	D-SG	GCP	PLR	M-R	1					6	7						PLANNED OBSOLESCENCE	SEE 33482-6285	34950-1210	34950-1220	
KEY A, BLACK	33482-1286	A-BLK	GCP	PLR	M-R		2	3					7	8	9			PLANNED OBSOLESCENCE	SEE 33482-6286	34950-1210	34950-1220	
KEY A, BLACK	33482-1287	A-BLK	GCP	PLR	M-R	1							7					PLANNED OBSOLESCENCE	SEE 33482-6287	34950-1210	34950-1220	
KEY A, BLACK	33482-1288	A-BLK	GCP	PLR	M-R	1					6							PLANNED OBSOLESCENCE	SEE 33482-6288	34950-1210	34950-1220	
KEY A, BLACK	33482-1289	A-BLK	GCP	PLR	M-R	1	2	3	4	5	6		8					PLANNED OBSOLESCENCE	SEE 33482-6289	34950-1210	34950-1220	
KEY A, BLACK	33482-1290	A-BLK	GCP	PLR	M-R	1							7				12	PLANNED OBSOLESCENCE	SEE 33482-6290	34950-1210	34950-1220	
KEY A, BLACK	33482-1291	A-BLK	GCP	PLR	M-R	1	2	3	4	5	6	7	8				12	PLANNED OBSOLESCENCE	SEE 33482-6291	34950-1210	34950-1220	
KEY A, BLACK	33482-1292	A-BLK	GCP	PLR	M-R									9				PLANNED OBSOLESCENCE	SEE 33482-6292	34950-1210	34950-1220	
KEY A, BLACK	33482-1293	A-BLK	GCP	PLR	M-R			3	4					9	10	11	12	PLANNED OBSOLESCENCE	SEE 33482-6293	34950-1210	34950-1220	
KEY A, BLACK	33482-1294	A-BLK	GCP	PLR	M-R	1	2			5	6	7	8					PLANNED OBSOLESCENCE	SEE 33482-6294	34950-1210	34950-1220	
KEY A, BLACK	33482-1295	A-BLK	GCP	PLR	M-R	1	2			5	6	7	8		11	12		PLANNED OBSOLESCENCE	SEE 33482-6295	34950-1210	34950-1220	
KEY A, BLACK	33482-1296	A-BLK	GCP	PLR	M-R	1	2	3	4	5	6	7	8	9	10			PLANNED OBSOLESCENCE	SEE 33482-6296	34950-1210	34950-1220	
KEY A, BLACK	33482-1297	A-BLK	GCP	PLR	M-R				4						10	11	12	PLANNED OBSOLESCENCE	SEE 33482-6297	34950-1210	34950-1220	
KEY A, BLACK	33482-1298	A-BLK	GCP	PLR	M-R						6					11	12	PLANNED OBSOLESCENCE	SEE 33482-6298	34950-1210	34950-1220	
KEY A, BLACK	33482-1299	A-BLK	GCP	PLR	M-R	1	2						7	8				PLANNED OBSOLESCENCE	SEE 33482-6299	34950-1210	34950-1220	
KEY A, BLACK	33482-1300	A-BLK	GCP	PLR	M-R	1	2	3						8		10	11	12	PLANNED OBSOLESCENCE	SEE 33482-6300	34950-1210	34950-1220
KEY A, BLACK	33482-1301	A-BLK	GCP	PLR	M-R	1	2						7	8			12	PLANNED OBSOLESCENCE	SEE 33482-6301	34950-1210	34950-1220	
KEY B, LIGHT GRAY	33482-1302	B-LG	GCP	PLR	M-R										10	11		PLANNED OBSOLESCENCE	SEE 33482-6302	34950-1210	34950-1220	
KEY A, BLACK	33482-1303	A-BLK	GCP	PLR	M-R	1	2	3	4				7	8	9	10		PLANNED OBSOLESCENCE	SEE 33482-6303	34950-1210	34950-1220	
KEY A, BLACK	33482-1304	A-BLK	GCP	PLR	M-R	1	2	3	4				7	8	9	10		PLANNED OBSOLESCENCE	SEE 33482-6304	34950-1210	34950-1220	
KEY B, LIGHT GRAY	33482-1305	B-LG	GCP	PLR	M-R										10	11	12	PLANNED OBSOLESCENCE	SEE 33482-6305	34950-1210	34950-1220	
KEY B, LIGHT GRAY	33482-1306	B-LG	GCP	PLR	M-R	1	2	3	4	5	6	7	8		10	11	12	PLANNED OBSOLESCENCE	SEE 33482-6306	34950-1210	34950-1220	
KEY A, BLACK	33482-1307	A-BLK	GCP	PLR	M-R	1	2	3	4	5			7	8				PLANNED OBSOLESCENCE	SEE 33482-6307	34950-1210	34950-1220	
KEY A, BLACK	33482-1308	A-BLK	GCP	PLR	M-R								7	8	9	10	11	12	PLANNED OBSOLESCENCE	SEE 33482-6308	34950-1210	34950-1220
KEY A, BLACK	33482-1309	A-BLK	GCP	PLR	M-R	1								8		10	11	12	PLANNED OBSOLESCENCE	SEE 33482-6309	34950-1210	34950-1220
KEY A, BLACK	33482-1310	A-BLK	GCP	PLR	M-R	1			4							11		PLANNED OBSOLESCENCE	SEE 33482-6310	34950-1210	34950-1220	
KEY A, BLACK	33482-1311	A-BLK	GCP	PLR	M-R	1	2		4	5	6	7		9	10	11	12	PLANNED OBSOLESCENCE	SEE 33482-6311	34950-1210	34950-1220	
KEY A, BLACK	33482-1312	A-BLK	GCP	PLR	M-R								8	9				PLANNED OBSOLESCENCE	SEE 33482-6312	34950-1210	34950-1220	
KEY A, BLACK	33482-1313	A-BLK	GCP	PLR	M-R			3	4	5	6		8	9	10	11		PLANNED OBSOLESCENCE	SEE 33482-6313	34950-1210	34950-1220	
KEY A, BLACK	33482-1314	A-BLK	GCP	PLR	M-R			3			6	7	8	9	10			PLANNED OBSOLESCENCE	SEE 33482-6314	34950-1210	34950-1220	
KEY A, BLACK	33482-1315	A-BLK	GCP	PLR	M-R						6	7	8	9				PLANNED OBSOLESCENCE	SEE 33482-6315	34950-1210	34950-1220	
KEY A, BLACK	33482-1316	A-BLK	GCP	PLR	M-R					5	6	7	8			11		PLANNED OBSOLESCENCE	SEE 33482-6316	34950-1210	34950-1220	
KEY A, BLACK	33482-1317	A-BLK	GCP	PLR	M-R	1	2											PLANNED OBSOLESCENCE	SEE 33482-6317	34950-1210	34950-1220	
KEY A, BLACK	33482-1318	A-BLK	GCP	PLR	M-R	1	2	3	4	5	6	7	8					PLANNED OBSOLESCENCE	SEE 33482-6318	34950-1210	34950-1220	
KEY A, BLACK	33482-1319	A-BLK	GCP	PLR	M-R	1	2	3	4	5	6	7	8	9				PLANNED OBSOLESCENCE	SEE 33482-6319	34950-1210	34950-1220	
KEY C, DARK GRAY	33482-1320	C-DG	GCP	PLR	M-R	1					6	7						PLANNED OBSOLESCENCE	SEE 33482-6320	34950-1210	34950-1220	
KEY C, BROWN	33482-1321	C-BR	GCP	PLR	M-R	1	2	3	4	5	6							PLANNED OBSOLESCENCE	SEE 33482-6321	34950-1210	34950-1220	
KEY C, BROWN	33482-1322	C-BR	GCP	PLR	M-R	1	2				5	6						PLANNED OBSOLESCENCE	SEE 33482-6322	34950-1210		

MX150 2X6 BLADE SEALED ASSY MAT SEAL
BOM AND PIN OUT SHEET

ASSEMBLY DESCRIPTION	ASSEMBLY PART NUMBER	COMPONENT				BLOCKED TERMINALS												STATUS	COMMENTS	OPTIONAL ATTACHMENTS SOLD SEPERATELY	
		THE PRESENCE OF AN ABBREVIATION INDICATES THE PRESENCE OF THAT COMPONENT.				CAVITY WITH A NUMBER INDICATES BLOCKED TERMINAL POSITION CAVITY WITHOUT A NUMBER INDICATES OPEN TERMINAL POSITION														BACKSHELL WITH RIBS	BACKSHELL WITHOUT RIBS
		HOUSING KEY/COLOR	GROMMET CAP	PLR	MAT SEAL	1	2	3	4	5	6	7	8	9	10	11	12				
KEY A, BLACK	33482-1334	A-BLK	GCP	PLR	M-R				4	5			8		10			PLANNED OBSOLESCENCE	SEE 33482-6334	34950-1210	34950-1220
KEY A, BLACK	33482-1335	A-BLK	GCP	PLR	M-R	1	2		4	5	6	7				12		PLANNED OBSOLESCENCE	SEE 33482-6335	34950-1210	34950-1220
KEY A, YELLOW	33482-1336	A-YL	GCP	PLR	M-R													PLANNED OBSOLESCENCE	SEE 33482-6336	34950-1210	34950-1220
KEY B, LIGHT GRAY	33482-1337	B-LG	GCP	PLR	M-R					5			8					PLANNED OBSOLESCENCE	SEE 33482-6337	34950-1210	34950-1220
KEY B, LIGHT GRAY	33482-1338	B-LG	GCP	PLR	M-R					5			8			11	12	PLANNED OBSOLESCENCE	SEE 33482-6338	34950-1210	34950-1220
KEY B, LIGHT GRAY	33482-1339	B-LG	GCP	PLR	M-R			3	4	5			8	9	10	11	12	PLANNED OBSOLESCENCE	SEE 33482-6339	34950-1210	34950-1220
KEY B, LIGHT GRAY	33482-1340	B-LG	GCP	PLR	M-R	1	2	3	4	5			8	9	10	11	12	PLANNED OBSOLESCENCE	SEE 33482-6340	34950-1210	34950-1220
KEY A, BLACK	33482-1341	A-BLK	GCP	PLR	M-R	1	2	3		5			9			11		PLANNED OBSOLESCENCE	SEE 33482-6341	34950-1210	34950-1220
KEY A, BLACK	33482-1342	A-BLK	GCP	PLR	M-R		2	3		5						11		PLANNED OBSOLESCENCE	SEE 33482-6342	34950-1210	34950-1220
KEY A, BLACK	33482-1343	A-BLK	GCP	PLR	M-R	1	2	3					9			11		PLANNED OBSOLESCENCE	SEE 33482-6343	34950-1210	34950-1220
KEY A, BLACK	33482-1344	A-BLK	GCP	PLR	M-R	1	2	3	4	5						11	12	PLANNED OBSOLESCENCE	SEE 33482-6344	34950-1210	34950-1220
KEY A, BLACK	33482-1345	A-BLK	GCP	PLR	M-R		2	3	4	5						11	12	PLANNED OBSOLESCENCE	SEE 33482-6345	34950-1210	34950-1220
KEY A, BLACK	33482-1346	A-BLK	GCP	PLR	M-R	1												PLANNED OBSOLESCENCE	SEE 33482-6346	34950-1210	34950-1220
KEY A, BLACK	33482-1347	A-BLK	GCP	PLR	M-R	1	2	3										PLANNED OBSOLESCENCE	SEE 33482-6347	34950-1210	34950-1220
KEY B, LIGHT GRAY	33482-1348	B-LG	GCP	PLR	M-R	1	2	3	4		6					11	12	PLANNED OBSOLESCENCE	SEE 33482-6348	34950-1210	34950-1220
KEY A, BLACK	33482-1349	A-BLK	GCP	PLR	M-R				4			7	8					PLANNED OBSOLESCENCE	SEE 33482-6349	34950-1210	34950-1220
KEY A, BLACK	33482-1350	A-BLK	GCP	PLR	M-R		2					8						PLANNED OBSOLESCENCE	SEE 33482-6350	34950-1210	34950-1220
KEY A, BLACK	33482-1351	A-BLK	GCP	PLR	M-R		2		4				8		10			PLANNED OBSOLESCENCE	SEE 33482-6351	34950-1210	34950-1220
KEY A, BLACK	33482-1352	A-BLK	GCP	PLR	M-R	1	2	3	4	5	6		8		10	11	12	PLANNED OBSOLESCENCE	SEE 33482-6352	34950-1210	34950-1220
KEY A, BLACK	33482-1353	A-BLK	GCP	PLR	M-R	1				6	7	8						PLANNED OBSOLESCENCE	SEE 33482-6353	34950-1210	34950-1220
KEY A, BLACK	33482-1354	A-BLK	GCP	PLR	M-R		2	3	4		6		8		10	11	12	PLANNED OBSOLESCENCE	SEE 33482-6354	34950-1210	34950-1220
KEY A, BLACK	33482-1355	A-BLK	GCP	PLR	M-R		2			6	7	8		10	11			PLANNED OBSOLESCENCE	SEE 33482-6355	34950-1210	34950-1220
KEY A, BLACK	33482-1356	A-BLK	GCP	PLR	M-R	1	2	3	4		6		8		10	11	12	PLANNED OBSOLESCENCE	SEE 33482-6356	34950-1210	34950-1220
KEY A, BLACK	33482-1357	A-BLK	GCP	PLR	M-R					5			8					PLANNED OBSOLESCENCE	SEE 33482-6357	34950-1210	34950-1220
KEY A, BLACK	33482-1358	A-BLK	GCP	PLR	M-R				4					10				PLANNED OBSOLESCENCE	SEE 33482-6358	34950-1210	34950-1220
KEY A, BLACK	33482-1359	A-BLK	GCP	PLR	M-R				4			7	8	9	10	11	12	PLANNED OBSOLESCENCE	SEE 33482-6359	34950-1210	34950-1220
KEY A, BLACK	33482-1360	A-BLK	GCP	PLR	M-R					5	6		8	9	10	11	12	PLANNED OBSOLESCENCE	SEE 33482-6360	34950-1210	34950-1220
KEY A, BLACK	33482-1361	A-BLK	GCP	PLR	M-R				4	5	6		8	9	10	11	12	PLANNED OBSOLESCENCE	SEE 33482-6361	34950-1210	34950-1220
KEY A, BLACK	33482-1362	A-BLK	GCP	PLR	M-R	1	2	3		5	6		8	9		11	12	PLANNED OBSOLESCENCE	SEE 33482-6362	34950-1210	34950-1220
KEY A, BLACK	33482-1363	A-BLK	GCP	PLR	M-R				4	5		7	8	9	10	11	12	PLANNED OBSOLESCENCE	SEE 33482-6363	34950-1210	34950-1220
KEY A, BLACK	33482-1364	A-BLK	GCP	PLR	M-R				4			7		9	10			PLANNED OBSOLESCENCE	SEE 33482-6364	34950-1210	34950-1220
KEY A, BLACK	33482-1365	A-BLK	GCP	PLR	M-R						6	7	8	9	10	11	12	PLANNED OBSOLESCENCE	SEE 33482-6365	34950-1210	34950-1220
KEY A, BLACK	33482-1366	A-BLK	GCP	PLR	M-R	1	2				6	7				11	12	PLANNED OBSOLESCENCE	SEE 33482-6366	34950-1210	34950-1220
KEY A, BLACK	33482-1367	A-BLK	GCP	PLR	M-R					5			8		10			PLANNED OBSOLESCENCE	SEE 33482-6367	34950-1210	34950-1220
KEY A, BLACK	33482-1368	A-BLK	GCP	PLR	M-R	1	2	3	4			7	8	9	10	11	12	PLANNED OBSOLESCENCE	SEE 33482-6368	34950-1210	34950-1220
KEY A, BLACK	33482-1369	A-BLK	GCP	PLR	M-R				4									PLANNED OBSOLESCENCE	SEE 33482-6369	34950-1210	34950-1220
KEY A, BLACK	33482-1370	A-BLK	GCP	PLR	M-R	1	2	3			6	7		10	11	12		PLANNED OBSOLESCENCE	SEE 33482-6370	34950-1210	34950-1220
KEY A, BLACK	33482-1371	A-BLK	GCP	PLR	M-R							7	8			11		PLANNED OBSOLESCENCE	SEE 33482-6371	34950-1210	34950-1220
KEY A, BLACK	33482-1372	A-BLK	GCP	PLR	M-R	1		3		5			8		10		12	PLANNED OBSOLESCENCE	SEE 33482-6372	34950-1210	34950-1220
KEY A, BLACK	33482-1373	A-BLK	GCP	PLR	M-R		2		4		6	7		9		11		PLANNED OBSOLESCENCE	SEE 33482-6373	34950-1210	34950-1220
KEY A, BLACK	33482-1374	A-BLK	GCP	PLR	M-R		2								10	11	12	PLANNED OBSOLESCENCE	SEE 33482-6374	34950-1210	34950-1220
KEY A, BLACK	33482-1375	A-BLK	GCP	PLR	M-R							7		9	10			PLANNED OBSOLESCENCE	SEE 33482-6375	34950-1210	34950-1220
KEY A, BLACK	33482-1376	A-BLK	GCP	PLR	M-R		2		4			7						PLANNED OBSOLESCENCE	SEE 33482-6376	34950-1210	34950-1220
KEY A, BLACK	33482-1377	A-BLK	GCP	PLR	M-R	1	2	3	4		6		9	10	11	12		PLANNED OBSOLESCENCE	SEE 33482-6377	34950-1210	34950-1220
KEY A, BLACK	33482-1378	A-BLK	GCP	PLR	M-R	1		3		5						11	12	PLANNED OBSOLESCENCE	SEE 33482-6378	34950-1210	34950-1220
KEY A, BLACK	33482-1379	A-BLK	GCP	PLR	M-R	1		3		5			8		10	11	12	PLANNED OBSOLESCENCE	SEE 33482-6379	34950-1210	34950-1220
KEY A, BLACK	33482-1380	A-BLK	GCP	PLR	M-R		2					7	8					PLANNED OBSOLESCENCE	SEE 33482-6380	34950-1210	34950-1220
KEY A, BLACK	33482-1381	A-BLK	GCP	PLR	M-R		2		4			7	8					PLANNED OBSOLESCENCE	SEE 33482-6381	34950-1210	34950-1220
KEY A, BLACK	33482-1382	A-BLK	GCP	PLR	M-R				4	5	6		8		10	11		PLANNED OBSOLESCENCE	SEE 33482-6382	34950-1210	34950-1220
KEY A, BLACK	33482-1383	A-BLK	GCP	PLR	M-R	1	2	3	4			7	8	9	10	11		PLANNED OBSOLESCENCE	SEE 33482-6383	34950-1210	34950-1220
KEY A, BLACK	33482-1384	A-BLK	GCP	PLR	M-R			3	4				9	10				PLANNED OBSOLESCENCE	SEE 33482-6384	34950-1210	34950-1220
KEY A, BLACK	33482-1385	A-BLK	GCP	PLR	M-R			3	4						11	12		PLANNED OBSOLESCENCE	SEE 33482-6385	34950-1210	34950-1220
KEY A, BLACK	33482-1386	A-BLK	GCP	PLR	M-R	1	2	3	4		6	7	8	9	10	11		PLANNED OBSOLESCENCE	SEE 33482-6386	34950-1210	34950-1220
KEY A, BLACK	33482-1387	A-BLK	GCP	PLR	M-R	1	2	3	4	5	6	7	8	9			12	PLANNED OBSOLESCENCE	SEE 33482-6387	34950-1210	34950-1220
KEY A, BLACK	33482-1388	A-BLK	GCP	PLR	M-R	1	2	3							10	11	12	PLANNED OBSOLESCENCE	SEE 33482-6388	34950-1210	34950-1220
KEY A, BLACK	33482-1389	A-BLK	GCP	PLR	M-R	1	2	3			6					11	12	PLANNED OBSOLESCENCE	SEE 33482-6389	34950-1210	34950-1220
KEY A, BLACK	33482-1390	A-BLK	GCP	PLR	M-R	1		3	4							11		PLANNED OBSOLESCENCE	SEE 33482-6390	34950-1210	34950-1220
KEY A, BLACK	33482-1391	A-BLK	GCP	PLR	M-R	1	2	3			6				10	11	12	PLANNED OBSOLESCENCE	SEE 33482-6391	34950-1210	34950-1220
KEY A, BLACK	33482-1392	A-BLK	GCP	PLR	M-R	1		3	4							11	12	PLANNED OBSOLESCENCE	SEE 33482-6392	34950-1210	34950-1220
KEY A, BLACK	33482-1393	A-BLK	GCP	PLR	M-R				4	5		7				11	12	PLANNED OBSOLESCENCE	SEE 33482-6393	34950-1210	34950-1220
KEY B, LIGHT GRAY	33482-1394	B-LG	GCP	PLR	M-R	1	2	3	4				8	9	10	11	12	PLANNED OBSOLESCENCE	SEE 33482-6394	34950-1210	34950-1220
KEY B, LIGHT GRAY	33482-1395	B-LG	GCP	PLR	M-R	1	2	3	4				8	9	10			PLANNED OBSOLESCENCE	SEE 33482-6395	34950-1210	34950-1220
KEY A, BLACK	33482-1396	A-BLK	GCP	PLR	M-R						6	7	8	9	10			PLANNED OBSOLESCENCE	SEE 33482-6396	34950-1210	34950-1220
KEY A, BLACK	33482-1397	A-BLK	GCP	PLR	M-R				4		6		8					PLANNED OBSOLESCENCE	SEE 33482-6397	34950-1210	34950-1220
KEY A, BLACK	33482-1398	A-BLK	GCP	PLR	M-R				4	5	6	7				11	12	PLANNED OBSOLESCENCE	SEE 33482-6398	34950-1210	34950-1220
KEY A, BLACK	33482-1399	A-BLK	GCP	PLR	M-R	1	2	3	4	5	6	7	8			11	12	PLANNED OBSOLESCENCE	SEE 33482-6399	34950-1210	34950-1220
KEY A, BLACK	33482-1400	A-BLK	GCP	PLR	M-R	1	2	3				7	8					PLANNED OBSOLESCENCE	SEE 33482-6400	34950-1210	34950-1220
KEY A, BLACK	33482-1401	A-BLK	GCP	PLR	M-R	1	2	3				7	8		10			PLANNED OBSOLESCENCE	SEE 33482-6401	34950-1210	34950-1220

MX150 2X6 BLADE SEALED ASSY MAT SEAL
BOM AND PIN OUT SHEET

ASSEMBLY DESCRIPTION	ASSEMBLY PART NUMBER	COMPONENT				BLOCKED TERMINALS												STATUS	COMMENTS	OPTIONAL ATTACHMENTS SOLD SEPERATELY	
		THE PRESENCE OF AN ABBREVIATION INDICATES THE PRESENCE OF THAT COMPONENT.				CAVITY WITH A NUMBER INDICATES BLOCKED TERMINAL POSITION CAVITY WITHOUT A NUMBER INDICATES OPEN TERMINAL POSITION														BACKSHELL WITH RIBS	BACKSHELL WITHOUT RIBS
		HOUSING KEY/COLOR	GROMMET CAP	PLR	MAT SEAL	1	2	3	4	5	6	7	8	9	10	11	12				
KEY A, BLACK	33482-1413	A-BLK	GCP	PLR	M-R	1		3		5						11		PLANNED OBSOLESCENCE	SEE 33482-6413	34950-1210	34950-1220
KEY A, BLACK	33482-1414	A-BLK	GCP	PLR	M-R	1		3		5			8		10	11		PLANNED OBSOLESCENCE	SEE 33482-6414	34950-1210	34950-1220
KEY A, BLACK	33482-1415	A-BLK	GCP	PLR	M-R		2	3		5	6	7		9		11	12	PLANNED OBSOLESCENCE	SEE 33482-6415	34950-1210	34950-1220
KEY A, BLACK	33482-1416	A-BLK	GCP	PLR	M-R	1			4	5	6		8		10	12		PLANNED OBSOLESCENCE	SEE 33482-6416	34950-1210	34950-1220
KEY A, BLACK	33482-1417	A-BLK	GCP	PLR	M-R	1			4	5			8		10	12		PLANNED OBSOLESCENCE	SEE 33482-6417	34950-1210	34950-1220
KEY A, BLACK	33482-1418	A-BLK	GCP	PLR	M-R	1	2	3	4	5			8		10	11	12	PLANNED OBSOLESCENCE	SEE 33482-6418	34950-1210	34950-1220
KEY A, BLACK	33482-1419	A-BLK	GCP	PLR	M-R		2	3		5	6	7		9	10	11	12	PLANNED OBSOLESCENCE	SEE 33482-6419	34950-1210	34950-1220
KEY A, BLACK	33482-1420	A-BLK	GCP	PLR	M-R	1	2	3	4				8		9			PLANNED OBSOLESCENCE	SEE 33482-6420	34950-1210	34950-1220
KEY A, BLACK	33482-1421	A-BLK	GCP	PLR	M-R		2	3						9				PLANNED OBSOLESCENCE	SEE 33482-6421	34950-1210	34950-1220
KEY A, BLACK	33482-1422	A-BLK	GCP	PLR	M-R								8		10	11		PLANNED OBSOLESCENCE	SEE 33482-6422	34950-1210	34950-1220
KEY A, BLACK	33482-1423	A-BLK	GCP	PLR	M-R	1		3		5					11			PLANNED OBSOLESCENCE	SEE 33482-6423	34950-1210	34950-1220
KEY A, BLACK	33482-1424	A-BLK	GCP	PLR	M-R	1		3		5			8		10	11		PLANNED OBSOLESCENCE	SEE 33482-6424	34950-1210	34950-1220
KEY A, BLACK	33482-1425	A-BLK	GCP	PLR	M-R		2		4		6	7	8	9	10	11	12	PLANNED OBSOLESCENCE	SEE 33482-6425	34950-1210	34950-1220
KEY A, BLACK	33482-1426	A-BLK	GCP	PLR	M-R			3	4						11	12		PLANNED OBSOLESCENCE	SEE 33482-6426	34950-1210	34950-1220
KEY A, BLACK	33482-1427	A-BLK	GCP	PLR	M-R			3	4					9	10	11	12	PLANNED OBSOLESCENCE	SEE 33482-6427	34950-1210	34950-1220
KEY A, BLACK	33482-1428	A-BLK	GCP	PLR	M-R	1	2			5	6	7	8	9	10			PLANNED OBSOLESCENCE	SEE 33482-6428	34950-1210	34950-1220
KEY A, BLACK	33482-1429	A-BLK	GCP	PLR	M-R									9	10			PLANNED OBSOLESCENCE	SEE 33482-6429	34950-1210	34950-1220
KEY A, BLACK	33482-1430	A-BLK	GCP	PLR	M-R			3	4	5	6		8	9				PLANNED OBSOLESCENCE	SEE 33482-6430	34950-1210	34950-1220
KEY B, LIGHT GRAY	33482-1431	B-LG	GCP	PLR	M-R	1	2	3	4				8			11	12	PLANNED OBSOLESCENCE	SEE 33482-6431	34950-1210	34950-1220
KEY B, LIGHT GRAY	33482-1432	B-LG	GCP	PLR	M-R	1	2	3	4				8					PLANNED OBSOLESCENCE	SEE 33482-6432	34950-1210	34950-1220
KEY A, BLACK	33482-1433	A-BLK	GCP	PLR	M-R										10	11	12	PLANNED OBSOLESCENCE	SEE 33482-6433	34950-1210	34950-1220
KEY B, LIGHT GRAY	33482-1434	B-LG	GCP	PLR	M-R							7	8	9		12		PLANNED OBSOLESCENCE	SEE 33482-6434	34950-1210	34950-1220
KEY A, BLACK	33482-1435	A-BLK	GCP	PLR	M-R								8	9	10	11	12	PLANNED OBSOLESCENCE	SEE 33482-6435	34950-1210	34950-1220
KEY A, BLACK	33482-1436	A-BLK	GCP	PLR	M-R		2						8	9	10	11	12	PLANNED OBSOLESCENCE	SEE 33482-6436	34950-1210	34950-1220
KEY A, BLACK	33482-1437	A-BLK	GCP	PLR	M-R		2						8	9				PLANNED OBSOLESCENCE	SEE 33482-6437	34950-1210	34950-1220
KEY B, LIGHT GRAY	33482-1438	B-LG	GCP	PLR	M-R	1	2	3	4				8			11	12	PLANNED OBSOLESCENCE	SEE 33482-6438	34950-1210	34950-1220
KEY B, LIGHT GRAY	33482-1439	B-LG	GCP	PLR	M-R	1	2	3	4				8					PLANNED OBSOLESCENCE	SEE 33482-6439	34950-1210	34950-1220
KEY A, BLACK	33482-1440	A-BLK	GCP	PLR	M-R	1	2				6			9	10			PLANNED OBSOLESCENCE	SEE 33482-6440	34950-1210	34950-1220
KEY A, BLACK	33482-1441	A-BLK	GCP	PLR	M-R	1	2	3			6	7			10	11	12	PLANNED OBSOLESCENCE	SEE 33482-6441	34950-1210	34950-1220
KEY A, BLACK	33482-1442	A-BLK	GCP	PLR	M-R		2		4		6		8					PLANNED OBSOLESCENCE	SEE 33482-6442	34950-1210	34950-1220
KEY A, BLACK	33482-1443	A-BLK	GCP	PLR	M-R		2		4		6							PLANNED OBSOLESCENCE	SEE 33482-6443	34950-1210	34950-1220
KEY A, BLACK	33482-1444	A-BLK	GCP	PLR	M-R			3	4		6		8	9				PLANNED OBSOLESCENCE	SEE 33482-6444	34950-1210	34950-1220
KEY A, BLACK	33482-1445	A-BLK	GCP	PLR	M-R			3	4		6	7		9	10	11	12	PLANNED OBSOLESCENCE	SEE 33482-6445	34950-1210	34950-1220
KEY C, DARK GRAY	33482-1446	C-DG	GCP	PLR	M-R			3	4									PLANNED OBSOLESCENCE	SEE 33482-6446	34950-1210	34950-1220
KEY A, BLACK	33482-6201	A-BLK	GCP	PLR	M-B													SALEABLE		34950-1210	34950-1220
KEY B, LIGHT GRAY	33482-6202	B-LG	GCP	PLR	M-B													SALEABLE		34950-1210	34950-1220
KEY C, BROWN	33482-6203	C-BR	GCP	PLR	M-B													NOT RECOMMENDED	SEE 33482-6261	34950-1210	34950-1220
KEY D, GREEN	33482-6204	D-GR	GCP	PLR	M-B													NOT RECOMMENDED	SEE 33482-6262	34950-1210	34950-1220
VOID KEY	33482-6205																				
KEY A, BLACK	33482-6206	A-BLK	GCP	PLR	M-B						6							SALEABLE		34950-1210	34950-1220
KEY B, LIGHT GRAY	33482-6207	B-LG	GCP	PLR	M-B						6							SALEABLE		34950-1210	34950-1220
KEY C, BROWN	33482-6208	C-BR	GCP	PLR	M-B						6							NOT RECOMMENDED		34950-1210	34950-1220
KEY D, GREEN	33482-6209	D-GR	GCP	PLR	M-B						6							NOT RECOMMENDED		34950-1210	34950-1220
VOID KEY	33482-6210																				
KEY A, BLACK	33482-6211	A-BLK	GCP	PLR	M-B						6	7						SALEABLE		34950-1210	34950-1220
KEY B, LIGHT GRAY	33482-6212	B-LG	GCP	PLR	M-B						6	7						SALEABLE		34950-1210	34950-1220
KEY C, BROWN	33482-6213	C-BR	GCP	PLR	M-B						6	7						NOT RECOMMENDED		34950-1210	34950-1220
KEY D, GREEN	33482-6214	D-GR	GCP	PLR	M-B						6	7						NOT RECOMMENDED		34950-1210	34950-1220
VOID KEY	33482-6215																				
KEY A, BLACK	33482-6216	A-BLK	GCP	PLR	M-B	1					6	7						SALEABLE		34950-1210	34950-1220
KEY B, LIGHT GRAY	33482-6217	B-LG	GCP	PLR	M-B	1					6	7						SALEABLE		34950-1210	34950-1220
KEY C, BROWN	33482-6218	C-BR	GCP	PLR	M-B	1					6	7						NOT RECOMMENDED	SEE 33482-6320	34950-1210	34950-1220
KEY D, GREEN	33482-6219	D-GR	GCP	PLR	M-B	1					6	7						NOT RECOMMENDED	SEE 33482-6285	34950-1210	34950-1220
VOID KEY	33482-6220																				
KEY A, BLACK	33482-6221	A-BLK	GCP	PLR	M-B	1					6	7					12	SALEABLE		34950-1210	34950-1220
KEY B, LIGHT GRAY	33482-6222	B-LG	GCP	PLR	M-B	1					6	7					12	SALEABLE		34950-1210	34950-1220
KEY C, BROWN	33482-6223	C-BR	GCP	PLR	M-B	1					6	7					12	NOT RECOMMENDED		34950-1210	34950-1220
KEY D, GREEN	33482-6224	D-GR	GCP	PLR	M-B	1					6	7					12	NOT RECOMMENDED		34950-1210	34950-1220
VOID KEY	33482-6225																				
KEY A, BLACK	33482-6226	A-BLK	GCP	PLR	M-B						6						12	SALEABLE		34950-1210	34950-1220
KEY A, BLACK	33482-6227	A-BLK	GCP	PLR	M-B	1	2	3	4	5	6	7	8	9	10	11	12	SALEABLE		34950-1210	34950-1220
KEY B, LIGHT GRAY	33482-6228	B-LG	GCP	PLR	M-B	1	2	3	4	5	6	7	8	9	10	11	12	SALEABLE		34950-1210	34950-1220
KEY C, BROWN	33482-6229	C-BR	GCP	PLR	M-B	1	2	3	4	5	6	7	8	9	10	11	12	NOT RECOMMENDED	SEE 33482-6263	34950-1210	34950-1220
KEY D, GREEN	33482-6230	D-GR	GCP	PLR	M-B	1	2	3	4	5	6	7	8	9	10	11	12	NOT RECOMMENDED	SEE 33482-6264	34950-1210	34950-1220
VOID KEY	33482-6231																				
KEY A, BLACK	33482-6232	A-BLK	GCP	PLR	M-B		2	3					8			11		SALEABLE		34950-1210	34950-1220
KEY A, BLACK	33482-6233	A-BLK	GCP	PLR	M-B		2	3		5	6	7	8			11		SALEABLE		34950-1210	34950-1220
KEY A, BLACK	33482-6234	A-BLK	GCP	PLR	M-B					6	7							SALEABLE		34950-1210	34950-1220
KEY A, BLACK	33482-6235	A-BLK	GCP	PLR	M-B		2	3			6	7	8		10	11		SALEABLE		34950-1210	34950-1220
KEY B, LIGHT GRAY	33482-6236	B-LG	GCP	PLR	M-B	1				5	6	7	8	9	10			SALEABLE		34950-1210	34950-1220
KEY A, BLACK	33482-6237	A-BLK	GCP	PLR	M-B		2											SALEABLE		34950-1210	34950-1220
KEY B, LIGHT GRAY	33482-6238	B-LG	GCP	PLR	M-B		2							9	10			SALEABLE		34950-1210	34950-1220
KEY A, BLACK	33482-6239	A-BLK	GCP	PLR	M-B	1				5	6	7	8					SALEABLE		34950-1210	34950-1220
KEY A, BLACK	33482-6240	A-BLK	GCP	PLR	M-B		2	3					8	9	10	11		SALEABLE		34950-1210	34

MX150 2X6 BLADE SEALED ASSY MAT SEAL
BOM AND PIN OUT SHEET

ASSEMBLY DESCRIPTION	ASSEMBLY PART NUMBER	COMPONENT				BLOCKED TERMINALS												STATUS	COMMENTS	OPTIONAL ATTACHMENTS SOLD SEPERATELY		
		THE PRESENCE OF AN ABBREVIATION INDICATES THE PRESENCE OF THAT COMPONENT.				CAVITY WITH A NUMBER INDICATES BLOCKED TERMINAL POSITION CAVITY WITHOUT A NUMBER INDICATES OPEN TERMINAL POSITION														BACKSHELL WITH RIBS	BACKSHELL WITHOUT RIBS	
		HOUSING KEY/COLOR	GROMMET CAP	PLR	MAT SEAL	1	2	3	4	5	6	7	8	9	10	11	12					
KEY A, BLACK	33482-6246	A-BLK	GCP	PLR	M-B												11	SALEABLE		34950-1210	34950-1220	
KEY A, BLACK	33482-6247	A-BLK	GCP	PLR	M-B														SALEABLE		34950-1210	34950-1220
KEY A, BLACK	33482-6248	A-BLK	GCP	PLR	M-B	1													SALEABLE		34950-1210	34950-1220
KEY A, BLACK	33482-6249	A-BLK	GCP	PLR	M-B														SALEABLE		34950-1210	34950-1220
KEY A, BLACK	33482-6250	A-BLK	GCP	PLR	M-B														SALEABLE		34950-1210	34950-1220
KEY A, BLACK	33482-6251	A-BLK	GCP	PLR	M-B														SALEABLE		34950-1210	34950-1220
KEY A, BLACK	33482-6252	A-BLK	GCP	PLR	M-B														SALEABLE		34950-1210	34950-1220
KEY A, BLACK	33482-6253	A-BLK	GCP	PLR	M-B														SALEABLE		34950-1210	34950-1220
KEY A, BLACK	33482-6254	A-BLK	GCP	PLR	M-B														SALEABLE		34950-1210	34950-1220
KEY A, BLACK	33482-6255	A-BLK	GCP	PLR	M-B														SALEABLE		34950-1210	34950-1220
KEY A, BLACK	33482-6256	A-BLK	GCP	PLR	M-B	1													SALEABLE		34950-1210	34950-1220
KEY A, BLACK	33482-6257	A-BLK	GCP	PLR	M-B														SALEABLE		34950-1210	34950-1220
KEY A, BLACK	33482-6258	A-BLK	GCP	PLR	M-B														SALEABLE		34950-1210	34950-1220
KEY A, BLACK	33482-6259	A-BLK	GCP	PLR	M-B	1													SALEABLE		34950-1210	34950-1220
KEY A, BLACK	33482-6260	A-BLK	GCP	PLR	M-B														SALEABLE		34950-1210	34950-1220
KEY C, DARK GRAY	33482-6261	C-DG	GCP	PLR	M-B														SALEABLE		34950-1210	34950-1220
KEY D, STONE GRAY	33482-6262	D-SG	GCP	PLR	M-B														SALEABLE		34950-1210	34950-1220
KEY C, DARK GRAY	33482-6263	C-DG	GCP	PLR	M-B	1													SALEABLE		34950-1210	34950-1220
KEY D, STONE GRAY	33482-6264	D-SG	GCP	PLR	M-B	1													SALEABLE		34950-1210	34950-1220
KEY A, BLACK	33482-6265	A-BLK	GCP	PLR	M-B														SALEABLE		34950-1210	34950-1220
KEY A, BLACK	33482-6266	A-BLK	GCP	PLR	M-B	1													SALEABLE		34950-1210	34950-1220
KEY A, BLACK	33482-6267	A-BLK	GCP	PLR	M-B														SALEABLE		34950-1210	34950-1220
KEY A, BLACK	33482-6268	A-BLK	GCP	PLR	M-B														SALEABLE		34950-1210	34950-1220
KEY A, BLACK	33482-6269	A-BLK	GCP	PLR	M-B	1													SALEABLE		34950-1210	34950-1220
KEY A, BLACK	33482-6270	A-BLK	GCP	PLR	M-B														SALEABLE		34950-1210	34950-1220
KEY A, BLACK	33482-6271	A-BLK	GCP	PLR	M-B														SALEABLE		34950-1210	34950-1220
KEY A, BLACK	33482-6272	A-BLK	GCP	PLR	M-B														SALEABLE		34950-1210	34950-1220
KEY A, BLACK	33482-6273	A-BLK	GCP	PLR	M-B														SALEABLE		34950-1210	34950-1220
KEY A, BLACK	33482-6274	A-BLK	GCP	PLR	M-B	1													SALEABLE		34950-1210	34950-1220
KEY A, BLACK	33482-6275	A-BLK	GCP	PLR	M-B														SALEABLE		34950-1210	34950-1220
KEY A, BLACK	33482-6276	A-BLK	GCP	PLR	M-B	1													SALEABLE		34950-1210	34950-1220
KEY A, BLACK	33482-6277	A-BLK	GCP	PLR	M-B	1													SALEABLE		34950-1210	34950-1220
KEY A, BLACK	33482-6278	A-BLK	GCP	PLR	M-B														SALEABLE		34950-1210	34950-1220
KEY A, BLACK	33482-6279	A-BLK	GCP	PLR	M-B	1													SALEABLE		34950-1210	34950-1220
KEY A, BLACK	33482-6280	A-BLK	GCP	PLR	M-B	1													SALEABLE		34950-1210	34950-1220
KEY A, BLACK	33482-6281	A-BLK	GCP	PLR	M-B														SALEABLE		34950-1210	34950-1220
KEY A, BLACK	33482-6282	A-BLK	GCP	PLR	M-B	1													SALEABLE		34950-1210	34950-1220
KEY A, BLACK	33482-6283	A-BLK	GCP	PLR	M-B														SALEABLE		34950-1210	34950-1220
KEY A, BLACK	33482-6284	A-BLK	GCP	PLR	M-B	1													SALEABLE		34950-1210	34950-1220
KEY D, STONE GRAY	33482-6285	D-SG	GCP	PLR	M-B	1													SALEABLE		34950-1210	34950-1220
KEY A, BLACK	33482-6286	A-BLK	GCP	PLR	M-B														SALEABLE		34950-1210	34950-1220
KEY A, BLACK	33482-6287	A-BLK	GCP	PLR	M-B	1													SALEABLE		34950-1210	34950-1220
KEY A, BLACK	33482-6288	A-BLK	GCP	PLR	M-B	1													SALEABLE		34950-1210	34950-1220
KEY A, BLACK	33482-6289	A-BLK	GCP	PLR	M-B	1													SALEABLE		34950-1210	34950-1220
KEY A, BLACK	33482-6290	A-BLK	GCP	PLR	M-B	1													SALEABLE		34950-1210	34950-1220
KEY A, BLACK	33482-6291	A-BLK	GCP	PLR	M-B	1													SALEABLE		34950-1210	34950-1220
KEY A, BLACK	33482-6292	A-BLK	GCP	PLR	M-B														SALEABLE		34950-1210	34950-1220
KEY A, BLACK	33482-6293	A-BLK	GCP	PLR	M-B														SALEABLE		34950-1210	34950-1220
KEY A, BLACK	33482-6294	A-BLK	GCP	PLR	M-B	1													SALEABLE		34950-1210	34950-1220
KEY A, BLACK	33482-6295	A-BLK	GCP	PLR	M-B	1													SALEABLE		34950-1210	34950-1220
KEY A, BLACK	33482-6296	A-BLK	GCP	PLR	M-B	1													SALEABLE		34950-1210	34950-1220
KEY A, BLACK	33482-6297	A-BLK	GCP	PLR	M-B														SALEABLE		34950-1210	34950-1220
KEY A, BLACK	33482-6298	A-BLK	GCP	PLR	M-B														SALEABLE		34950-1210	34950-1220
KEY A, BLACK	33482-6299	A-BLK	GCP	PLR	M-B	1													SALEABLE		34950-1210	34950-1220
KEY A, BLACK	33482-6300	A-BLK	GCP	PLR	M-B	1													SALEABLE		34950-1210	34950-1220
KEY A, BLACK	33482-6301	A-BLK	GCP	PLR	M-B	1													SALEABLE		34950-1210	34950-1220
KEY B, LIGHT GRAY	33482-6302	B-LG	GCP	PLR	M-B														SALEABLE		34950-1210	34950-1220
KEY A, BLACK	33482-6303	A-BLK	GCP	PLR	M-B	1													SALEABLE		34950-1210	34950-1220
KEY A, BLACK	33482-6304	A-BLK	GCP	PLR	M-B	1													SALEABLE		34950-1210	34950-1220
KEY B, LIGHT GRAY	33482-6305	B-LG	GCP	PLR	M-B														SALEABLE		34950-1210	34950-1220
KEY B, LIGHT GRAY	33482-6306	B-LG	GCP	PLR	M-B	1													SALEABLE		34950-1210	34950-1220
KEY A, BLACK	33482-6307	A-BLK	GCP	PLR	M-B	1													SALEABLE		34950-1210	34950-1220
KEY A, BLACK	33482-6308	A-BLK	GCP	PLR	M-B														SALEABLE		34950-1210	34950-1220
KEY A, BLACK	33482-6309	A-BLK	GCP	PLR	M-B	1													SALEABLE		34950-1210	34950-1220
KEY A, BLACK	33482-6310	A-BLK	GCP	PLR	M-B	1													SALEABLE		34950-1210	34950-1220
KEY A, BLACK	33482-6311	A-BLK	GCP	PLR	M-B	1													SALEABLE		34950-1210	34950-1220
KEY A, BLACK	33482-6312	A-BLK	GCP	PLR	M-B														SALEABLE		34950-1210	34950-1220
KEY A, BLACK	33482-6313	A-BLK	GCP	PLR	M-B														SALEABLE		34950-1210	34950-1220
KEY A, BLACK	33482-6314	A-BLK	GCP	PLR	M-B														SALEABLE		34950-1210	34950-1220
KEY A, BLACK	33482-6315	A-BLK	GCP	PLR	M-B														SALEABLE		34950-1210	34950-1220
KEY A, BLACK	33482-6316	A-BLK	GCP	PLR	M-B														SALEABLE		34950-1210	34950-1220
KEY A, BLACK	33482-6317	A-BLK	GCP	PLR	M-B	1													SALEABLE		34950-1210	34950-1220
KEY A, BLACK	33482-6318	A-BLK	GCP	PLR	M-B	1													SALEABLE		34950-1210	34950-1220
KEY A, BLACK	33482-6319	A-BLK	GCP	PLR	M-B	1													SALEABLE		34950-1210	34950-1220
KEY C, DARK GRAY	33482-6320	C-DG	GCP	PLR	M-B	1													SALEABLE		34950-1210	34950-1220
KEY C, BROWN	33482-6321	C-BR	GCP	PLR	M-B	1													NOT RECOMMENDED	SEE 33482-6328	34950-1210	34950-1220
KEY C, BROWN	33482-6322	C-BR	GCP	PLR	M-B	1													NOT RECOMMENDED	SEE 33482-6329	34950-1210	34950-1220
KEY A, BLACK	33482-6323	A-BLK	GCP	PLR	M-B														SALEABLE		34950-1210	34950-1220
KEY A, BLACK	33482-6324	A-BLK	GCP	PLR	M-B														SALEABLE		34950-1210	34950-1220

MX150 2X6 BLADE SEALED ASSY MAT SEAL
BOM AND PIN OUT SHEET

ASSEMBLY DESCRIPTION	ASSEMBLY PART NUMBER	COMPONENT				BLOCKED TERMINALS												STATUS	COMMENTS	OPTIONAL ATTACHMENTS SOLD SEPERATELY	
		THE PRESENCE OF AN ABBREVIATION INDICATES THE PRESENCE OF THAT COMPONENT.				CAVITY WITH A NUMBER INDICATES BLOCKED TERMINAL POSITION CAVITY WITHOUT A NUMBER INDICATES OPEN TERMINAL POSITION														BACKSHELL WITH RIBS	BACKSHELL WITHOUT RIBS
		HOUSING KEY/COLOR	GROMMET CAP	PLR	MAT SEAL	1	2	3	4	5	6	7	8	9	10	11	12				
KEY A, BLACK	33482-6325	A-BLK	GCP	PLR	M-B			3					9					SALEABLE		34950-1210	34950-1220
KEY A, BLACK	33482-6326	A-BLK	GCP	PLR	M-B					5	6		7		10		11	SALEABLE		34950-1210	34950-1220
KEY A, BLACK	33482-6327	A-BLK	GCP	PLR	M-B							7					11	SALEABLE		34950-1210	34950-1220
KEY C, DARK GRAY	33482-6328	C-DG	GCP	PLR	M-B	1	2	3	4	5	6							SALEABLE		34950-1210	34950-1220
KEY C, DARK GRAY	33482-6329	C-DG	GCP	PLR	M-B	1	2			5	6							SALEABLE		34950-1210	34950-1220
KEY A, BLACK	33482-6330	A-BLK	GCP	PLR	M-B	1	2	3	4					9	10	11	12	SALEABLE		34950-1210	34950-1220
KEY A, BLACK	33482-6331	A-BLK	GCP	PLR	M-B	1	2				6	7	8				12	SALEABLE		34950-1210	34950-1220
KEY A, BLACK	33482-6332	A-BLK	GCP	PLR	M-B				4	5		7	8	9	10			SALEABLE		34950-1210	34950-1220
KEY A, BLACK	33482-6333	A-BLK	GCP	PLR	M-B				4					9	10			SALEABLE		34950-1210	34950-1220
KEY A, BLACK	33482-6334	A-BLK	GCP	PLR	M-B				4	5			8		10			SALEABLE		34950-1210	34950-1220
KEY A, BLACK	33482-6335	A-BLK	GCP	PLR	M-B	1	2		4	5	6	7					12	SALEABLE		34950-1210	34950-1220
KEY A, YELLOW	33482-6336	A-YL	GCP	PLR	M-B													SALEABLE		34950-1210	34950-1220
KEY B, LIGHT GRAY	33482-6337	B-LG	GCP	PLR	M-B					5			8					SALEABLE		34950-1210	34950-1220
KEY B, LIGHT GRAY	33482-6338	B-LG	GCP	PLR	M-B					5			8			11	12	SALEABLE		34950-1210	34950-1220
KEY B, LIGHT GRAY	33482-6339	B-LG	GCP	PLR	M-B				3	4	5		8	9	10	11	12	SALEABLE		34950-1210	34950-1220
KEY B, LIGHT GRAY	33482-6340	B-LG	GCP	PLR	M-B	1	2	3	4	5			8	9	10	11	12	SALEABLE		34950-1210	34950-1220
KEY A, BLACK	33482-6341	A-BLK	GCP	PLR	M-B	1	2	3		5				9		11		SALEABLE		34950-1210	34950-1220
KEY A, BLACK	33482-6342	A-BLK	GCP	PLR	M-B		2	3		5						11		SALEABLE		34950-1210	34950-1220
KEY A, BLACK	33482-6343	A-BLK	GCP	PLR	M-B	1	2	3						9		11		SALEABLE		34950-1210	34950-1220
KEY A, BLACK	33482-6344	A-BLK	GCP	PLR	M-B	1	2	3	4	5				9		11	12	SALEABLE		34950-1210	34950-1220
KEY A, BLACK	33482-6345	A-BLK	GCP	PLR	M-B		2	3	4	5						11	12	SALEABLE		34950-1210	34950-1220
KEY A, BLACK	33482-6346	A-BLK	GCP	PLR	M-B	1												SALEABLE		34950-1210	34950-1220
KEY A, BLACK	33482-6347	A-BLK	GCP	PLR	M-B	1	2	3										SALEABLE		34950-1210	34950-1220
KEY B, LIGHT GRAY	33482-6348	B-LG	GCP	PLR	M-B	1	2	3	4		6					11	12	SALEABLE		34950-1210	34950-1220
KEY A, BLACK	33482-6349	A-BLK	GCP	PLR	M-B				4				7	8				SALEABLE		34950-1210	34950-1220
KEY A, BLACK	33482-6350	A-BLK	GCP	PLR	M-B		2						8					SALEABLE		34950-1210	34950-1220
KEY A, BLACK	33482-6351	A-BLK	GCP	PLR	M-B		2		4				8		10			SALEABLE		34950-1210	34950-1220
KEY A, BLACK	33482-6352	A-BLK	GCP	PLR	M-B	1	2	3	4	5	6		8		10	11	12	SALEABLE		34950-1210	34950-1220
KEY A, BLACK	33482-6353	A-BLK	GCP	PLR	M-B	1					6	7	8				12	SALEABLE		34950-1210	34950-1220
KEY A, BLACK	33482-6354	A-BLK	GCP	PLR	M-B		2	3	4		6		8		10	11	12	SALEABLE		34950-1210	34950-1220
KEY A, BLACK	33482-6355	A-BLK	GCP	PLR	M-B		2				6	7	8		10	11		SALEABLE		34950-1210	34950-1220
KEY A, BLACK	33482-6356	A-BLK	GCP	PLR	M-B	1	2	3	4		6		8		10	11	12	SALEABLE		34950-1210	34950-1220
KEY A, BLACK	33482-6357	A-BLK	GCP	PLR	M-B					5			8					SALEABLE		34950-1210	34950-1220
KEY A, BLACK	33482-6358	A-BLK	GCP	PLR	M-B				4						10			SALEABLE		34950-1210	34950-1220
KEY A, BLACK	33482-6359	A-BLK	GCP	PLR	M-B				4			7	8	9	10	11	12	SALEABLE		34950-1210	34950-1220
KEY A, BLACK	33482-6360	A-BLK	GCP	PLR	M-B					5	6		8	9	10	11	12	SALEABLE		34950-1210	34950-1220
KEY A, BLACK	33482-6361	A-BLK	GCP	PLR	M-B				4	5	6		8	9	10	11	12	SALEABLE		34950-1210	34950-1220
KEY A, BLACK	33482-6362	A-BLK	GCP	PLR	M-B	1	2	3		5	6	7	8	9		11	12	SALEABLE		34950-1210	34950-1220
KEY A, BLACK	33482-6363	A-BLK	GCP	PLR	M-B				4	5		7	8	9	10	11	12	SALEABLE		34950-1210	34950-1220
KEY A, BLACK	33482-6364	A-BLK	GCP	PLR	M-B				4			7	8	9	10			SALEABLE		34950-1210	34950-1220
KEY A, BLACK	33482-6365	A-BLK	GCP	PLR	M-B						6	7	8	9	10	11	12	SALEABLE		34950-1210	34950-1220
KEY A, BLACK	33482-6366	A-BLK	GCP	PLR	M-B	1	2				6	7	8	9		11	12	SALEABLE		34950-1210	34950-1220
KEY A, BLACK	33482-6367	A-BLK	GCP	PLR	M-B					5			8		10			SALEABLE		34950-1210	34950-1220
KEY A, BLACK	33482-6368	A-BLK	GCP	PLR	M-B	1	2	3	4			7	8	9	10	11	12	SALEABLE		34950-1210	34950-1220
KEY A, BLACK	33482-6369	A-BLK	GCP	PLR	M-B				4									SALEABLE		34950-1210	34950-1220
KEY A, BLACK	33482-6370	A-BLK	GCP	PLR	M-B	1	2	3			6	7		10	11	12		SALEABLE		34950-1210	34950-1220
KEY A, BLACK	33482-6371	A-BLK	GCP	PLR	M-B							7	8			11		SALEABLE		34950-1210	34950-1220
KEY A, BLACK	33482-6372	A-BLK	GCP	PLR	M-B	1		3		5			8		10		12	SALEABLE		34950-1210	34950-1220
KEY A, BLACK	33482-6373	A-BLK	GCP	PLR	M-B		2		4		6	7		9		11		SALEABLE		34950-1210	34950-1220
KEY A, BLACK	33482-6374	A-BLK	GCP	PLR	M-B		2							10		11	12	SALEABLE		34950-1210	34950-1220
KEY A, BLACK	33482-6375	A-BLK	GCP	PLR	M-B							7		9	10			SALEABLE		34950-1210	34950-1220
KEY A, BLACK	33482-6376	A-BLK	GCP	PLR	M-B		2		4			7						SALEABLE		34950-1210	34950-1220
KEY A, BLACK	33482-6377	A-BLK	GCP	PLR	M-B	1	2	3	4		6			9	10	11	12	SALEABLE		34950-1210	34950-1220
KEY A, BLACK	33482-6378	A-BLK	GCP	PLR	M-B	1		3		5						11	12	SALEABLE		34950-1210	34950-1220
KEY A, BLACK	33482-6379	A-BLK	GCP	PLR	M-B	1		3		5			8		10	11	12	SALEABLE		34950-1210	34950-1220
KEY A, BLACK	33482-6380	A-BLK	GCP	PLR	M-B		2					7	8					SALEABLE		34950-1210	34950-1220
KEY A, BLACK	33482-6381	A-BLK	GCP	PLR	M-B		2		4			7	8					SALEABLE		34950-1210	34950-1220
KEY A, BLACK	33482-6382	A-BLK	GCP	PLR	M-B				4	5	6		8		10	11		SALEABLE		34950-1210	34950-1220
KEY A, BLACK	33482-6383	A-BLK	GCP	PLR	M-B	1	2	3	4			7	8	9	10	11		SALEABLE		34950-1210	34950-1220
KEY A, BLACK	33482-6384	A-BLK	GCP	PLR	M-B			3	4					9	10			SALEABLE		34950-1210	34950-1220
KEY A, BLACK	33482-6385	A-BLK	GCP	PLR	M-B			3	4							11	12	SALEABLE		34950-1210	34950-1220
KEY A, BLACK	33482-6386	A-BLK	GCP	PLR	M-B	1	2	3	4		6	7	8	9	10	11		SALEABLE		34950-1210	34950-1220
KEY A, BLACK	33482-6387	A-BLK	GCP	PLR	M-B	1	2	3	4	5	6	7	8	9			12	SALEABLE		34950-1210	34950-1220
KEY A, BLACK	33482-6388	A-BLK	GCP	PLR	M-B	1	2	3							10	11	12	SALEABLE		34950-1210	34950-1220
KEY A, BLACK	33482-6389	A-BLK	GCP	PLR	M-B	1	2	3			6					11	12	SALEABLE		34950-1210	34950-1220
KEY A, BLACK	33482-6390	A-BLK	GCP	PLR	M-B	1		3	4							11		SALEABLE		34950-1210	34950-1220
KEY A, BLACK	33482-6391	A-BLK	GCP	PLR	M-B	1	2	3			6				10	11	12	SALEABLE		34950-1210	34950-1220
KEY A, BLACK	33482-6392	A-BLK	GCP	PLR	M-B	1		3	4							11	12	SALEABLE		34950-1210	34950-1220
KEY A, BLACK	33482-6393	A-BLK	GCP	PLR	M-B			4	5			7				11	12	SALEABLE		34950-1210	34950-1220
KEY B, LIGHT GRAY	33482-6394	B-LG	GCP	PLR	M-B	1	2	3	4				8	9	10	11	12	SALEABLE		34950-1210	34950-1220
KEY B, LIGHT GRAY	33482-6395	B-LG	GCP	PLR	M-B	1	2	3	4				8	9	10			SALEABLE		34950-1210	34950-1220
KEY A, BLACK	33482-6396	A-BLK	GCP	PLR	M-B	1					6	7	8	9	10			SALEABLE		34950-1210	34950-1220
KEY A, BLACK	33482-6397	A-BLK	GCP	PLR	M-B				4			6						SALEABLE		34950-1210	34950-1220
KEY A, BLACK	33482-6398	A-BLK	GCP	PLR	M-B				4	5	6	7				11	12	SALEABLE		34950-1210	34950-1220
KEY A, BLACK	33482-6399	A-BLK	GCP	PLR	M-B	1	2	3	4	5	6	7	8			11	12	SALEABLE		34950-1210	34950-1220
KEY A, BLACK	33482-6400	A-BLK	GCP	PLR	M-B																

MX150 2X6 BLADE SEALED ASSY MAT SEAL
BOM AND PIN OUT SHEET

ASSEMBLY DESCRIPTION	ASSEMBLY PART NUMBER	COMPONENT				BLOCKED TERMINALS												STATUS	COMMENTS	OPTIONAL ATTACHMENTS SOLD SEPERATELY	
		THE PRESENCE OF AN ABBREVIATION INDICATES THE PRESENCE OF THAT COMPONENT.				CAVITY WITH A NUMBER INDICATES BLOCKED TERMINAL POSITION CAVITY WITHOUT A NUMBER INDICATES OPEN TERMINAL POSITION														BACKSHELL WITH RIBS	BACKSHELL WITHOUT RIBS
		HOUSING KEY/COLOR	GROMMET CAP	PLR	MAT SEAL	1	2	3	4	5	6	7	8	9	10	11	12				
KEY A, BLACK	33482-6404	A-BLK	GCP	PLR	M-B					5	6	7	8				12	SALEABLE		34950-1210	34950-1220
KEY A, BLACK	33482-6405	A-BLK	GCP	PLR	M-B							7	8				12	SALEABLE		34950-1210	34950-1220
KEY A, BLACK	33482-6406	A-BLK	GCP	PLR	M-B		2	3		5	6	7		9	10	11	12	SALEABLE		34950-1210	34950-1220
KEY A, BLACK	33482-6407	A-BLK	GCP	PLR	M-B			3							10	11	12	SALEABLE		34950-1210	34950-1220
KEY A, BLACK	33482-6408	A-BLK	GCP	PLR	M-B				4	5	6	7	8		10	11	12	SALEABLE		34950-1210	34950-1220
KEY A, BLACK	33482-6409	A-BLK	GCP	PLR	M-B			3	4	5	6	7	8		10	11	12	SALEABLE		34950-1210	34950-1220
KEY A, BLACK	33482-6410	A-BLK	GCP	PLR	M-B	1	2	3	4				8	9				SALEABLE		34950-1210	34950-1220
KEY A, BLACK	33482-6411	A-BLK	GCP	PLR	M-B		2	3						9				SALEABLE		34950-1210	34950-1220
KEY A, BLACK	33482-6412	A-BLK	GCP	PLR	M-B								8		10	11		SALEABLE		34950-1210	34950-1220
KEY A, BLACK	33482-6413	A-BLK	GCP	PLR	M-B	1		3		5						11		SALEABLE		34950-1210	34950-1220
KEY A, BLACK	33482-6414	A-BLK	GCP	PLR	M-B	1		3		5			8		10	11		SALEABLE		34950-1210	34950-1220
KEY A, BLACK	33482-6415	A-BLK	GCP	PLR	M-B		2	3		5	6	7		9		11	12	SALEABLE		34950-1210	34950-1220
KEY A, BLACK	33482-6416	A-BLK	GCP	PLR	M-B	1			4	5	6		8		10		12	SALEABLE		34950-1210	34950-1220
KEY A, BLACK	33482-6417	A-BLK	GCP	PLR	M-B	1			4	5			8		10		12	SALEABLE		34950-1210	34950-1220
KEY A, BLACK	33482-6418	A-BLK	GCP	PLR	M-B	1	2	3	4	5			8		10	11	12	SALEABLE		34950-1210	34950-1220
KEY A, BLACK	33482-6419	A-BLK	GCP	PLR	M-B		2	3		5	6	7		9	10	11	12	SALEABLE	SEE 33482-6406	34950-1210	34950-1220
KEY A, BLACK	33482-6420	A-BLK	GCP	PLR	M-B	1	2	3	4				8	9				SALEABLE	SEE 33482-6410	34950-1210	34950-1220
KEY A, BLACK	33482-6421	A-BLK	GCP	PLR	M-B		2	3						9				SALEABLE	SEE 33482-6411	34950-1210	34950-1220
KEY A, BLACK	33482-6422	A-BLK	GCP	PLR	M-B								8		10	11		SALEABLE	SEE 33482-6412	34950-1210	34950-1220
KEY A, BLACK	33482-6423	A-BLK	GCP	PLR	M-B	1		3		5					11			SALEABLE	SEE 33482-6413	34950-1210	34950-1220
KEY A, BLACK	33482-6424	A-BLK	GCP	PLR	M-B	1		3		5			8		10	11		SALEABLE	SEE 33482-6414	34950-1210	34950-1220
KEY A, BLACK	33482-6425	A-BLK	GCP	PLR	M-B		2		4		6	7	8	9	10	11	12	SALEABLE		34950-1210	34950-1220
KEY A, BLACK	33482-6426	A-BLK	GCP	PLR	M-B				3	4						11	12	SALEABLE	SEE 33482-6385	34950-1210	34950-1220
KEY A, BLACK	33482-6427	A-BLK	GCP	PLR	M-B				3	4				9	10	11	12	SALEABLE	SEE 33482-6293	34950-1210	34950-1220
KEY A, BLACK	33482-6428	A-BLK	GCP	PLR	M-B	1	2			5	6	7	8	9	10			SALEABLE		34950-1210	34950-1220
KEY A, BLACK	33482-6429	A-BLK	GCP	PLR	M-B									9	10			SALEABLE		34950-1210	34950-1220
KEY A, BLACK	33482-6430	A-BLK	GCP	PLR	M-B				3	4	5	6		8	9			SALEABLE		34950-1210	34950-1220
KEY B, LIGHT GRAY	33482-6431	B-LG	GCP	PLR	M-B	1	2	3	4				8			11	12	SALEABLE		34950-1210	34950-1220
KEY B, LIGHT GRAY	33482-6432	B-LG	GCP	PLR	M-B	1	2	3	4				8					SALEABLE		34950-1210	34950-1220
KEY A, BLACK	33482-6433	A-BLK	GCP	PLR	M-B										10	11	12	SALEABLE	SEE 33482-6249	34950-1210	34950-1220
KEY B, LIGHT GRAY	33482-6434	B-LG	GCP	PLR	M-B							7	8	9			12	SALEABLE		34950-1210	34950-1220
KEY A, BLACK	33482-6435	A-BLK	GCP	PLR	M-B							7	8	9	10	11	12	SALEABLE	SEE 33482-6308	34950-1210	34950-1220
KEY A, BLACK	33482-6436	A-BLK	GCP	PLR	M-B		2						8	9	10	11	12	SALEABLE		34950-1210	34950-1220
KEY A, BLACK	33482-6437	A-BLK	GCP	PLR	M-B		2						8	9				SALEABLE		34950-1210	34950-1220
KEY B, LIGHT GRAY	33482-6438	B-LG	GCP	PLR	M-B	1	2	3	4				8			11	12	NOT RECOMMENDED	SEE 33482-6431	34950-1210	34950-1220
KEY B, LIGHT GRAY	33482-6439	B-LG	GCP	PLR	M-B	1	2	3	4				8					NOT RECOMMENDED	SEE 33482-6432	34950-1210	34950-1220
KEY A, BLACK	33482-6440	A-BLK	GCP	PLR	M-B	1	2			6				9	10			SALEABLE		34950-1210	34950-1220
KEY A, BLACK	33482-6441	A-BLK	GCP	PLR	M-B	1	2	3		6	7			10	11	12		SALEABLE	SEE 33482-6370	34950-1210	34950-1220
KEY A, BLACK	33482-6442	A-BLK	GCP	PLR	M-B		2		4	6		8						SALEABLE		34950-1210	34950-1220
KEY A, BLACK	33482-6443	A-BLK	GCP	PLR	M-B		2		4	6								SALEABLE		34950-1210	34950-1220
KEY A, BLACK	33482-6444	A-BLK	GCP	PLR	M-B				3	4	6		8	9				SALEABLE		34950-1210	34950-1220
KEY A, BLACK	33482-6445	A-BLK	GCP	PLR	M-B				4			7		9	10	11	12	SALEABLE		34950-1210	34950-1220
KEY C, DARK GRAY	33482-6446	C-DG	GCP	PLR	M-B				3	4								SALEABLE		34950-1210	34950-1220

MX150 2X8 BLADE SEALED ASSY MAT SEAL
BOM AND PIN OUT SHEET

ASSEMBLY DESCRIPTION	ASSEMBLY PART NUMBER	COMPONENT				BLOCKED TERMINALS																STATUS	COMMENTS	OPTIONAL ATTACHMENTS SOLD SEPERATELY		
		THE PRESENCE OF AN ABBREVIATION INDICATES THE PRESENCE OF THAT COMPONENT.				CAVITY WITH A NUMBER INDICATES BLOCKED TERMINAL POSITION CAVITY WITHOUT A NUMBER INDICATES OPEN TERMINAL POSITION																		BACKSHELL WITH RIBS	BACKSHELL WITHOUT RIBS	
		HOUSING KEY/COLOR	GROMMET CAP	PLR	MAT SEAL	1	2	3	4	5	6	7	8	9	10	11	12	13	14	15	16					
KEY A, BLACK	33482-1665	A-BLK	GCP	PLR	M-R			3	4	5	6	7	8		10	11			15	16	PLANNED OBSOLESCENCE	SEE 33482-8665				
KEY A, BLACK	33482-1666	A-BLK	GCP	PLR	M-R		2				6	7	8		10			13	14	15	16	PLANNED OBSOLESCENCE	SEE 33482-8666			
KEY A, BLACK	33482-1667	A-BLK	GCP	PLR	M-R		2			5	6				10			13	14	15	16	PLANNED OBSOLESCENCE	SEE 33482-8667			
KEY A, BLACK	33482-1668	A-BLK	GCP	PLR	M-R		2			5	6				10	11		13	14	15	16	PLANNED OBSOLESCENCE	SEE 33482-8668			
KEY A, BLACK	33482-1669	A-BLK	GCP	PLR	M-R		2				6				10			13	14			PLANNED OBSOLESCENCE	SEE 33482-8669			
KEY A, BLACK	33482-1670	A-BLK	GCP	PLR	M-R		2		4	5	6	7	8		10	11	12	13	14			PLANNED OBSOLESCENCE	SEE 33482-8670			
KEY A, BLACK	33482-1671	A-BLK	GCP	PLR	M-R		2		4	5	6				10		12	13	14			PLANNED OBSOLESCENCE	SEE 33482-8671			
KEY A, BLACK	33482-1672	A-BLK	GCP	PLR	M-R				4				8									PLANNED OBSOLESCENCE	SEE 33482-8672			
KEY A, BLACK	33482-1673	A-BLK	GCP	PLR	M-R		2				6	7	8									PLANNED OBSOLESCENCE	SEE 33482-8673			
KEY A, BLACK	33482-1674	A-BLK	GCP	PLR	M-R		2				5	6										PLANNED OBSOLESCENCE	SEE 33482-8674			
KEY A, BLACK	33482-1675	A-BLK	GCP	PLR	M-R		2				5	6				11						PLANNED OBSOLESCENCE	SEE 33482-8675			
KEY A, BLACK	33482-1676	A-BLK	GCP	PLR	M-R					5	6	7	8					13				PLANNED OBSOLESCENCE	SEE 33482-8676			
KEY A, BLACK	33482-1677	A-BLK	GCP	PLR	M-R					5	6	7	8			11						PLANNED OBSOLESCENCE	SEE 33482-8677			
KEY A, BLACK	33482-1678	A-BLK	GCP	PLR	M-R					5	6	7	8					12	13	14		PLANNED OBSOLESCENCE	SEE 33482-8678			
KEY A, BLACK	33482-1679	A-BLK	GCP	PLR	M-R					5	6	7	8			11	12	13	14			PLANNED OBSOLESCENCE	SEE 33482-8679			
KEY A, BLACK	33482-1680	A-BLK	GCP	PLR	M-R					5	6	7	8			11	12	13	14	15		PLANNED OBSOLESCENCE	SEE 33482-8680			
KEY A, BLACK	33482-1681	A-BLK	GCP	PLR	M-R							7								15		PLANNED OBSOLESCENCE	SEE 33482-8681			
KEY A, BLACK	33482-1682	A-BLK	GCP	PLR	M-R						4	5	6							15	16	PLANNED OBSOLESCENCE	SEE 33482-8682			
KEY A, BLACK	33482-1683	A-BLK	GCP	PLR	M-R			3	4	5	6									15	16	PLANNED OBSOLESCENCE	SEE 33482-8683			
KEY A, BLACK	33482-1684	A-BLK	GCP	PLR	M-R	1	2	3	4	5	6							13		15	16	PLANNED OBSOLESCENCE	SEE 33482-8684			
KEY A, BLACK	33482-1685	A-BLK	GCP	PLR	M-R													13	14	15	16	PLANNED OBSOLESCENCE	SEE 33482-8685			
KEY A, BLACK	33482-1686	A-BLK	GCP	PLR	M-R								8					13	14	15	16	PLANNED OBSOLESCENCE	SEE 33482-8686			
KEY A, BLACK	33482-1687	A-BLK	GCP	PLR	M-R								7	8		11	12	13	14	15		PLANNED OBSOLESCENCE	SEE 33482-8687			
KEY A, BLACK	33482-1688	A-BLK	GCP	PLR	M-R								7	8			12	13	14	15		PLANNED OBSOLESCENCE	SEE 33482-8688			
KEY A, BLACK	33482-1689	A-BLK	GCP	PLR	M-R								7	8		11		13				PLANNED OBSOLESCENCE	SEE 33482-8689			
KEY A, BLACK	33482-1690	A-BLK	GCP	PLR	M-R								7	8								PLANNED OBSOLESCENCE	SEE 33482-8690			
KEY A, BLACK	33482-1691	A-BLK	GCP	PLR	M-R					5								13				PLANNED OBSOLESCENCE	SEE 33482-8691			
KEY A, BLACK	33482-1692	A-BLK	GCP	PLR	M-R		2													15	16	PLANNED OBSOLESCENCE	SEE 33482-8692			
KEY A, BLACK	33482-1693	A-BLK	GCP	PLR	M-R		2							9	10					15	16	PLANNED OBSOLESCENCE	SEE 33482-8693			
KEY A, BLACK	33482-1694	A-BLK	GCP	PLR	M-R		2			5	6	7	8	9	10				14	15	16	PLANNED OBSOLESCENCE	SEE 33482-8694			
KEY A, BLACK	33482-1695	A-BLK	GCP	PLR	M-R		2			5	6	7	8		10				14	15	16	PLANNED OBSOLESCENCE	SEE 33482-8695			
KEY A, BLACK	33482-1700	A-BLK	GCP	PLR	M-R	1	2	3	4	5	6				10	11	12	13	14	15	16	PLANNED OBSOLESCENCE	SEE 33482-8700			
KEY A, BLACK	33482-1701	A-BLK	GCP	PLR	M-R	1	2	3	4	5	6				11	12	13	14	15	16		PLANNED OBSOLESCENCE	SEE 33482-8701			
KEY A, BLACK	33482-1702	A-BLK	GCP	PLR	M-R							7	8	9	10	11	12	13	14	15	16	PLANNED OBSOLESCENCE	SEE 33482-8702			
KEY A, BLACK	33482-1703	A-BLK	GCP	PLR	M-R								8	9	10	11	12	13	14	15	16	PLANNED OBSOLESCENCE	SEE 33482-8703			
KEY A, BLACK	33482-1704	A-BLK	GCP	PLR	M-R	1	2	3	4	5	6								14	15	16	PLANNED OBSOLESCENCE	SEE 33482-8704			
KEY A, BLACK	33482-1705	A-BLK	GCP	PLR	M-R										10	11	12	13	14	15	16	PLANNED OBSOLESCENCE	SEE 33482-8705			
KEY A, BLACK	33482-1706	A-BLK	GCP	PLR	M-R										11	12	13	14	15	16		PLANNED OBSOLESCENCE	SEE 33482-8706			
KEY A, BLACK	33482-1707	A-BLK	GCP	PLR	M-R								7	8	9	10						PLANNED OBSOLESCENCE	SEE 33482-8707			
KEY A, BLACK	33482-1708	A-BLK	GCP	PLR	M-R														14	15	16	PLANNED OBSOLESCENCE	SEE 33482-8708			
KEY A, BLACK	33482-1709	A-BLK	GCP	PLR	M-R													12	13	14	15	16	PLANNED OBSOLESCENCE	SEE 33482-8709		
KEY A, BLACK	33482-1710	A-BLK	GCP	PLR	M-R	1	2	3	4	5	6	7	8	9	10							PLANNED OBSOLESCENCE	SEE 33482-8710			
KEY B, LIGHT GRAY	33482-1711	B-LG	GCP	PLR	M-R	1	2	3	4	5	6	7	8	9	10				14	15	16	PLANNED OBSOLESCENCE	SEE 33482-8711			
KEY B, LIGHT GRAY	33482-1712	B-LG	GCP	PLR	M-R	1	2	3	4	5	6	7	8	9	10			12		14	15	16	PLANNED OBSOLESCENCE	SEE 33482-8712		
KEY A, BLACK	33482-1713	A-BLK	GCP	PLR	M-R		2	3	4					9	10					15	16	PLANNED OBSOLESCENCE	SEE 33482-8713			
KEY A, BLACK	33482-1714	A-BLK	GCP	PLR	M-R		2	3	4	5	6	7	8	9	10			12		14	15	16	PLANNED OBSOLESCENCE	SEE 33482-8714		
KEY A, BLACK	33482-1715	A-BLK	GCP	PLR	M-R	1	2	3	4					9	10	11	12			15	16	PLANNED OBSOLESCENCE	SEE 33482-8715			
KEY A, BLACK	33482-1716	A-BLK	GCP	PLR	M-R	1	2	3	4					9	10	11	12			16		PLANNED OBSOLESCENCE	SEE 33482-8716			
KEY A, BLACK	33482-1717	A-BLK	GCP	PLR	M-R	1	2	3	4	5	6	7	8					13	14	15	16	PLANNED OBSOLESCENCE	SEE 33482-8717			
KEY A, BLACK	33482-1718	A-BLK	GCP	PLR	M-R													13	14	15	16	PLANNED OBSOLESCENCE	SEE 33482-8718			
KEY A, BLACK	33482-1719	A-BLK	GCP	PLR	M-R	1				5					10	11			14	15	16	PLANNED OBSOLESCENCE	SEE 33482-8719			
KEY A, BLACK	33482-1720	A-BLK	GCP	PLR	M-R													12		14		PLANNED OBSOLESCENCE	SEE 33482-8720			
KEY B, LIGHT GRAY	33482-1721	B-LG	GCP	PLR	M-R				4		6	7	8			11	12	13	14			PLANNED OBSOLESCENCE	SEE 33482-8721			
KEY B, LIGHT GRAY	33482-1722	B-LG	GCP	PLR	M-R	1	2	3	4		6	7	8	9	10	11	12	13	14	15		PLANNED OBSOLESCENCE	SEE 33482-8722			
KEY A, BLACK	33482-1723	A-BLK	GCP	PLR	M-R	1	2	3	4	5	6							13	14	15	16	PLANNED OBSOLESCENCE	SEE 33482-8723			
KEY A, BLACK	33482-1724	A-BLK	GCP	PLR	M-R														14	15		PLANNED OBSOLESCENCE	SEE 33482-8724			
KEY C, DARK GRAY	33482-1725	C-DG	GCP	PLR	M-R																	PLANNED OBSOLESCENCE	SEE 33482-8725			
KEY D, STONE GRAY	33482-1726	D-SG	GCP	PLR	M-R																	PLANNED OBSOLESCENCE	SEE 33482-8726			
KEY C, DARK GRAY	33482-1727	C-DG	GCP	PLR	M-R	1	2	3	4	5	6	7	8	9	10	11	12	13	14	15	16	PLANNED OBSOLESCENCE	SEE 33482-8727			
KEY D, STONE GRAY	33482-1728	D-SG	GCP	PLR	M-R	1	2	3	4	5	6	7	8	9	10	11	12	13	14	15	16	PLANNED OBSOLESCENCE	SEE 33482-8728			
KEY A, BLACK	33482-1729	A-BLK	GCP	PLR	M-R								8	9								PLANNED OBSOLESCENCE	SEE 33482-8729			
KEY A, BLACK	33482-1730	A-BLK	GCP	PLR	M-R				4	5	6	7	8	9	10	11	12	13	14	15	16	PLANNED OBSOLESCENCE	SEE 33482-8730			
KEY A, BLACK	33482-1731	A-BLK	GCP	PLR	M-R									9	10	11	12	13	14	15	16	PLANNED OBSOLESCENCE	SEE 33482-8731			
KEY B, LIGHT GRAY	33482-1732	B-LG	GCP	PLR	M-R						6	7	8			11						PLANNED OBSOLESCENCE	SEE 33482-8732			
KEY B, LIGHT GRAY	33482-1733	B-LG	GCP	PLR	M-R	1	2	3	4	5	6			9	10	11	12	13	14	15	16	PLANNED OBSOLESCENCE	SEE 33482-8733			
KEY B, LIGHT GRAY	33482-1734	B-LG	GCP	PLR	M-R						6				9					15	16	PLANNED OBSOLESCENCE	SEE 33482-8734			
KEY A, BLACK	33482-1735	A-BLK	GCP	PLR	M-R						6					10	11	12	13	14		PLANNED OBSOLESCENCE	SEE 33482-8735			
KEY A, BLACK	33482-1736	A-BLK	GCP	PLR	M-R	1	2	3	4	5	6								13	14		PLANNED OBSOLESCENCE	SEE 33482-8736			
KEY A,																										

MX150 2X8 BLADE SEALED ASSY MAT SEAL
BOM AND PIN OUT SHEET

ASSEMBLY DESCRIPTION	ASSEMBLY PART NUMBER	COMPONENT				BLOCKED TERMINALS																STATUS	COMMENTS	OPTIONAL ATTACHMENTS SOLD SEPERATELY				
		THE PRESENCE OF AN ABBREVIATION INDICATES THE PRESENCE OF THAT COMPONENT.				CAVITY WITH A NUMBER INDICATES BLOCKED TERMINAL POSITION CAVITY WITHOUT A NUMBER INDICATES OPEN TERMINAL POSITION																		BACKSHELL WITH RIBS	BACKSHELL WITHOUT RIBS			
		HOUSING KEY/COLOR	GROMMET CAP	PLR	MAT SEAL	1	2	3	4	5	6	7	8	9	10	11	12	13	14	15	16							
KEY D, STONE GRAY	33482-1758	D-SG	GCP	PLR	M-R	1						8	9									16	PLANNED OBSOLESCENCE	SEE 33482-8758				
KEY A, BLACK	33482-1759	A-BLK	GCP	PLR	M-R	1	2	3	4	5													16	PLANNED OBSOLESCENCE	SEE 33482-8759			
KEY A, BLACK	33482-1760	A-BLK	GCP	PLR	M-R		2						7	9	10	11	12	13	14				16	PLANNED OBSOLESCENCE	SEE 33482-8760			
KEY A, BLACK	33482-1761	A-BLK	GCP	PLR	M-R		2			5				9										16	PLANNED OBSOLESCENCE	SEE 33482-8761		
KEY A, BLACK	33482-1762	A-BLK	GCP	PLR	M-R	1	2			5			7	9	10	11	12	13	14				16	PLANNED OBSOLESCENCE	SEE 33482-8762			
KEY A, BLACK	33482-1763	A-BLK	GCP	PLR	M-R							7											16	PLANNED OBSOLESCENCE	SEE 33482-8763			
KEY A, BLACK	33482-1764	A-BLK	GCP	PLR	M-R					5	6	7		9		11	12	13	14				16	PLANNED OBSOLESCENCE	SEE 33482-8764			
KEY A, BLACK	33482-1765	A-BLK	GCP	PLR	M-R		2			5		7		9		12	13	14					16	PLANNED OBSOLESCENCE	SEE 33482-8765			
KEY A, BLACK	33482-1766	A-BLK	GCP	PLR	M-R					5	6	7		9	10	11	12	13	14				16	PLANNED OBSOLESCENCE	SEE 33482-8766			
KEY A, BLACK	33482-1767	A-BLK	GCP	PLR	M-R					5	6	7		9									16	PLANNED OBSOLESCENCE	SEE 33482-8767			
KEY A, BLACK	33482-1768	A-BLK	GCP	PLR	M-R					5	6	7		9	10								16	PLANNED OBSOLESCENCE	SEE 33482-8768			
KEY A, BLACK	33482-1769	A-BLK	GCP	PLR	M-R	1			4	5	6		8					12	13	14			16	PLANNED OBSOLESCENCE	SEE 33482-8769			
KEY A, BLACK	33482-1770	A-BLK	GCP	PLR	M-R	1	2		4	5	6		8	9	10			12	13	14	15	16	16	PLANNED OBSOLESCENCE	SEE 33482-8770			
KEY A, BLACK	33482-1771	A-BLK	GCP	PLR	M-R	1			4				8		10			13	14	15				16	PLANNED OBSOLESCENCE	SEE 33482-8771		
KEY A, BLACK	33482-1772	A-BLK	GCP	PLR	M-R								8		10			13	14	15	16			16	PLANNED OBSOLESCENCE	SEE 33482-8772		
KEY A, BLACK	33482-1773	A-BLK	GCP	PLR	M-R	1	2	3	4	5	6					11	12							16	PLANNED OBSOLESCENCE	SEE 33482-8773		
KEY A, BLACK	33482-1774	A-BLK	GCP	PLR	M-R										10						15			16	PLANNED OBSOLESCENCE	SEE 33482-8774		
KEY A, BLACK	33482-1775	A-BLK	GCP	PLR	M-R									9	10						15	16		16	PLANNED OBSOLESCENCE	SEE 33482-8775		
KEY A, BLACK	33482-1776	A-BLK	GCP	PLR	M-R			3	4						9	10					15	16		16	PLANNED OBSOLESCENCE	SEE 33482-8776		
KEY A, YELLOW	33482-1777	A-YW	GCP	PLR	M-R																			16	PLANNED OBSOLESCENCE	SEE 33482-8777		
KEY A, BLACK	33482-1778	A-BLK	GCP	PLR	M-R					5			8											16	PLANNED OBSOLESCENCE	SEE 33482-8778		
KEY A, BLACK	33482-1779	A-BLK	GCP	PLR	M-R					5	6	7	8	9	10	11	12							16	PLANNED OBSOLESCENCE	SEE 33482-8779		
KEY A, BLACK	33482-1780	A-BLK	GCP	PLR	M-R			3	4	5	6							13	14					16	PLANNED OBSOLESCENCE	SEE 33482-8780		
KEY A, BLACK	33482-1781	A-BLK	GCP	PLR	M-R	1			4	5	6	7	8	9	10			13	14	15				16	PLANNED OBSOLESCENCE	SEE 33482-8781		
KEY A, BLACK	33482-1782	A-BLK	GCP	PLR	M-R	1			4			6	7	8				11	12	13	14	15		16	PLANNED OBSOLESCENCE	SEE 33482-8782		
KEY A, BLACK	33482-1783	A-BLK	GCP	PLR	M-R													11	12			15		16	PLANNED OBSOLESCENCE	SEE 33482-8783		
KEY A, BLACK	33482-1784	A-BLK	GCP	PLR	M-R			3																16	PLANNED OBSOLESCENCE	SEE 33482-8784		
KEY A, BLACK	33482-1785	A-BLK	GCP	PLR	M-R	1				5			7				11	12	13	14	15	16		16	PLANNED OBSOLESCENCE	SEE 33482-8785		
KEY A, BLACK	33482-1786	A-BLK	GCP	PLR	M-R		2			5	PLR	M-R		9			11	12	13	14	15	16		16	PLANNED OBSOLESCENCE	SEE 33482-8786		
KEY A, BLACK	33482-1787	A-BLK	GCP	PLR	M-R	1	2			5				9										16	PLANNED OBSOLESCENCE	SEE 33482-8787		
KEY A, BLACK	33482-1788	A-BLK	GCP	PLR	M-R	1	2						7	9			11	12	13	14	15	16		16	PLANNED OBSOLESCENCE	SEE 33482-8788		
KEY A, BLACK	33482-1789	A-BLK	GCP	PLR	M-R	1	2			5				9								15		16	PLANNED OBSOLESCENCE	SEE 33482-8789		
KEY A, BLACK	33482-1790	A-BLK	GCP	PLR	M-R	1	2			5			7	9			11	12	13	14	15	16		16	PLANNED OBSOLESCENCE	SEE 33482-8790		
KEY A, BLACK	33482-1791	A-BLK	GCP	PLR	M-R	1	2	3						9										16	PLANNED OBSOLESCENCE	SEE 33482-8791		
KEY A, BLACK	33482-1792	A-BLK	GCP	PLR	M-R		2			5			7											16	PLANNED OBSOLESCENCE	SEE 33482-8792		
KEY A, BLACK	33482-1793	A-BLK	GCP	PLR	M-R										10	11								16	PLANNED OBSOLESCENCE	SEE 33482-8793		
KEY A, BLACK	33482-1794	A-BLK	GCP	PLR	M-R	1	2	3		5	6							12	13					16	PLANNED OBSOLESCENCE	SEE 33482-8794		
KEY A, BLACK	33482-1795	A-BLK	GCP	PLR	M-R			3							10			13	14	15				16	PLANNED OBSOLESCENCE	SEE 33482-8795		
KEY A, BLACK	33482-1796	A-BLK	GCP	PLR	M-R								7	9					14	15	16			16	PLANNED OBSOLESCENCE	SEE 33482-8796		
KEY A, BLACK	33482-1797	A-BLK	GCP	PLR	M-R								7	8					12					16	PLANNED OBSOLESCENCE	SEE 33482-8797		
KEY A, BLACK	33482-1798	A-BLK	GCP	PLR	M-R			3							10	11	12	13	14	15	16			16	PLANNED OBSOLESCENCE	SEE 33482-8798		
KEY A, BLACK	33482-1799	A-BLK	GCP	PLR	M-R			3	4	5	6	7			10						15	16		16	PLANNED OBSOLESCENCE	SEE 33482-8799		
KEY A, BLACK	33482-1800	A-BLK	GCP	PLR	M-R	1	2			5								13	14					16	PLANNED OBSOLESCENCE	SEE 33482-8800		
KEY A, BLACK	33482-1801	A-BLK	GCP	PLR	M-R					5	PLR	M-R	7	8	9	10	11	12	13	14				16	PLANNED OBSOLESCENCE	SEE 33482-8801		
KEY A, BLACK	33482-1802	A-BLK	GCP	PLR	M-R					5								13	14					16	PLANNED OBSOLESCENCE	SEE 33482-8802		
KEY A, BLACK	33482-1803	A-BLK	GCP	PLR	M-R	1	2			5														16	PLANNED OBSOLESCENCE	SEE 33482-8803		
KEY A, BLACK	33482-1804	A-BLK	GCP	PLR	M-R	1	2			5			7	8	9	10	11	12	13	14				16	PLANNED OBSOLESCENCE	SEE 33482-8804		
KEY A, BLACK	33482-1805	A-BLK	GCP	PLR	M-R							6			10	11	12	13	14	15	16			16	PLANNED OBSOLESCENCE	SEE 33482-8805		
KEY A, BLACK	33482-1806	A-BLK	GCP	PLR	M-R							6						13	14	15	16			16	PLANNED OBSOLESCENCE	SEE 33482-8806		
KEY A, BLACK	33482-1807	A-BLK	GCP	PLR	M-R							6						13	14					16	PLANNED OBSOLESCENCE	SEE 33482-8807		
KEY A, BLACK	33482-1808	A-BLK	GCP	PLR	M-R	1	2	3	4	5	6							13	14	15	16			16	PLANNED OBSOLESCENCE	SEE 33482-8808		
KEY A, BLACK	33482-1809	A-BLK	GCP	PLR	M-R	1							8								15			16	PLANNED OBSOLESCENCE	SEE 33482-8809		
KEY A, BLACK	33482-1810	A-BLK	GCP	PLR	M-R	1															15			16	PLANNED OBSOLESCENCE	SEE 33482-8810		
KEY A, BLACK	33482-1811	A-BLK	GCP	PLR	M-R								8					13						16	PLANNED OBSOLESCENCE	SEE 33482-8811		
KEY A, BLACK	33482-1812	A-BLK	GCP	PLR	M-R								8											16	PLANNED OBSOLESCENCE	SEE 33482-8812		
KEY A, BLACK	33482-1813	A-BLK	GCP	PLR	M-R				4	5	6	7	8		10					14	15	16		16	PLANNED OBSOLESCENCE	SEE 33482-8813		
KEY A, BLACK	33482-1814	A-BLK	GCP	PLR	M-R								7		10									16	PLANNED OBSOLESCENCE	SEE 33482-8814		
KEY A, BLACK	33482-1815	A-BLK	GCP	PLR	M-R	1				3	5	6						12	13					16	PLANNED OBSOLESCENCE	SEE 33482-8815		
KEY A, BLACK	33482-1816	A-BLK	GCP	PLR	M-R			3		5	6	7			10					14	15	16		16	PLANNED OBSOLESCENCE	SEE 33482-8816		
KEY A, BLACK	33482-1817	A-BLK	GCP	PLR	M-R											11	12			14	15	16		16	PLANNED OBSOLESCENCE	SEE 33482-8817		
KEY A, BLACK	33482-1818	A-BLK	GCP	PLR	M-R							6	7	8		10	11	12	13	14	15			16	PLANNED OBSOLESCENCE	SEE 33482-8818		
KEY A, BLACK	33482-1819	A-BLK	GCP	PLR	M-R	1	2						7	9	10	11	12	13	14					16	PLANNED OBSOLESCENCE	SEE 33482-8819		
KEY A, BLACK	33482-1820	A-BLK	GCP	PLR	M-R								7	9										16	PLANNED OBSOLESCENCE	SEE 33482-8820		
KEY A, BLACK	33482-1821	A-BLK	GCP	PLR	M-R		2	3					7	9	10	11						15	16	16	PLANNED OBSOLESCENCE	SEE 33482-8821		
KEY A, BLACK	33482-1822	A-BLK	GCP</																									

MX150 2X8 BLADE SEALED ASSY MAT SEAL
BOM AND PIN OUT SHEET

ASSEMBLY DESCRIPTION	ASSEMBLY PART NUMBER	COMPONENT				BLOCKED TERMINALS																STATUS	COMMENTS	OPTIONAL ATTACHMENTS SOLD SEPERATELY		
		THE PRESENCE OF AN ABBREVIATION INDICATES THE PRESENCE OF THAT COMPONENT.				CAVITY WITH A NUMBER INDICATES BLOCKED TERMINAL POSITION CAVITY WITHOUT A NUMBER INDICATES OPEN TERMINAL POSITION																		BACKSHELL WITH RIBS	BACKSHELL WITHOUT RIBS	
		HOUSING KEY/COLOR	GROMMET CAP	PLR	MAT SEAL	1	2	3	4	5	6	7	8	9	10	11	12	13	14	15	16					
KEY A, BLACK	33482-1847	A-BLK	GCP	PLR	M-R	1	2				6	7	8	9	10				14	15	16	PLANNED OBSOLESCENCE	SEE 33482-8847			
KEY A, BLACK	33482-1848	A-BLK	GCP	PLR	M-R	1	2					7	8	9	10					15	16		PLANNED OBSOLESCENCE	SEE 33482-8848		
KEY A, BLACK	33482-1849	A-BLK	GCP	PLR	M-R			3	4	5	6	7	8			11	12	13	14	15	16	PLANNED OBSOLESCENCE	SEE 33482-8849			
KEY A, BLACK	33482-1850	A-BLK	GCP	PLR	M-R						6	7	8						14	15	16	PLANNED OBSOLESCENCE	SEE 33482-8850			
KEY A, BLACK	33482-1851	A-BLK	GCP	PLR	M-R							7	8							15	16		PLANNED OBSOLESCENCE	SEE 33482-8851		
KEY A, BLACK	33482-1852	A-BLK	GCP	PLR	M-R			3	4	5	6	7	8	9							16		PLANNED OBSOLESCENCE	SEE 33482-8852		
KEY A, BLACK	33482-1853	A-BLK	GCP	PLR	M-R				4					9			12						PLANNED OBSOLESCENCE	SEE 33482-8853		
KEY A, BLACK	33482-1854	A-BLK	GCP	PLR	M-R				4					9	10		12						PLANNED OBSOLESCENCE	SEE 33482-8854		
KEY A, BLACK	33482-1855	A-BLK	GCP	PLR	M-R			3	4					9	10			13	14				PLANNED OBSOLESCENCE	SEE 33482-8855		
KEY A, BLACK	33482-1856	A-BLK	GCP	PLR	M-R	1	2		4			6	7	8	9			12					PLANNED OBSOLESCENCE	SEE 33482-8856		
KEY A, BLACK	33482-1857	A-BLK	GCP	PLR	M-R	1	2		4			6	7	8	9	10		12					PLANNED OBSOLESCENCE	SEE 33482-8857		
KEY A, BLACK	33482-1858	A-BLK	GCP	PLR	M-R	1	2	3	4			6	7	8	9	10			13	14		16	PLANNED OBSOLESCENCE	SEE 33482-8858		
KEY A, BLACK	33482-1859	A-BLK	GCP	PLR	M-R		2				5		7	8	9	10	11	12	13	14		16	PLANNED OBSOLESCENCE	SEE 33482-8859		
KEY A, BLACK	33482-1860	A-BLK	GCP	PLR	M-R										10	11	12	13				16	PLANNED OBSOLESCENCE	SEE 33482-8860		
KEY A, BLACK	33482-8601	A-BLK	GCP	PLR	M-B																		SALEABLE			
KEY B, LIGHT GRAY	33482-8602	B-LG	GCP	PLR	M-B																		SALEABLE			
KEY C, BROWN	33482-8603	C-BR	GCP	PLR	M-B																		NOT RECOMMENDED	SEE 33482-8725		
KEY D, GREEN	33482-8604	D-GR	GCP	PLR	M-B																		NOT RECOMMENDED	SEE 33482-8726		
VOID KEY	33482-8605																									
KEY A, BLACK	33482-8606	A-BLK	GCP	PLR	M-B								8										SALEABLE			
KEY B, LIGHT GRAY	33482-8607	B-LG	GCP	PLR	M-B								8										SALEABLE			
KEY C, BROWN	33482-8608	C-BR	GCP	PLR	M-B								8										NOT RECOMMENDED	SEE 33482-8751		
KEY D, GREEN	33482-8609	D-GR	GCP	PLR	M-B								8										NOT RECOMMENDED	SEE 33482-8752		
VOID KEY	33482-8610																									
KEY A, BLACK	33482-8611	A-BLK	GCP	PLR	M-B								8	9									SALEABLE			
KEY B, LIGHT GRAY	33482-8612	B-LG	GCP	PLR	M-B								8	9									SALEABLE			
KEY C, BROWN	33482-8613	C-BR	GCP	PLR	M-B								8	9									NOT RECOMMENDED	SEE 33482-8753		
KEY D, GREEN	33482-8614	D-GR	GCP	PLR	M-B								8	9									NOT RECOMMENDED	SEE 33482-8754		
VOID KEY	33482-8615																									
KEY A, BLACK	33482-8616	A-BLK	GCP	PLR	M-B	1							8	9									SALEABLE			
KEY B, LIGHT GRAY	33482-8617	B-LG	GCP	PLR	M-B	1							8	9									SALEABLE			
KEY C, BROWN	33482-8618	C-BR	GCP	PLR	M-B	1							8	9									NOT RECOMMENDED	SEE 33482-8755		
KEY D, GREEN	33482-8619	D-GR	GCP	PLR	M-B	1							8	9									NOT RECOMMENDED	SEE 33482-8756		
VOID KEY	33482-8620																									
KEY A, BLACK	33482-8621	A-BLK	GCP	PLR	M-B	1	2	3	4	5	6	7	8	9	10	11	12	13	14	15	16		SALEABLE			
KEY B, LIGHT GRAY	33482-8622	B-LG	GCP	PLR	M-B	1	2	3	4	5	6	7	8	9	10	11	12	13	14	15	16		SALEABLE			
KEY C, BROWN	33482-8623	C-BR	GCP	PLR	M-B	1	2	3	4	5	6	7	8	9	10	11	12	13	14	15	16		NOT RECOMMENDED	SEE 33482-8727		
KEY D, GREEN	33482-8624	D-GR	GCP	PLR	M-B	1	2	3	4	5	6	7	8	9	10	11	12	13	14	15	16		NOT RECOMMENDED	SEE 33482-8728		
VOID KEY	33482-8625																									
KEY A, BLACK	33482-8626	A-BLK	GCP	PLR	M-B																15		SALEABLE			
KEY A, BLACK	33482-8627	A-BLK	GCP	PLR	M-B	1							8	9									SALEABLE			
KEY B, LIGHT GRAY	33482-8628	B-LG	GCP	PLR	M-B	1							8	9									SALEABLE			
KEY C, BROWN	33482-8629	C-BR	GCP	PLR	M-B	1							8	9									NOT RECOMMENDED	SEE 33482-8757		
KEY D, GREEN	33482-8630	D-GR	GCP	PLR	M-B	1							8	9									NOT RECOMMENDED	SEE 33482-8758		
VOID KEY	33482-8631																									
KEY A, BLACK	33482-8632	A-BLK	GCP	PLR	M-B				4				7	8			12	13	14				SALEABLE			
KEY A, BLACK	33482-8633	A-BLK	GCP	PLR	M-B			3	4	5					10	11	12	13	14	15	16		SALEABLE			
KEY A, BLACK	33482-8634	A-BLK	GCP	PLR	M-B								7	8				12	13	14			SALEABLE			
KEY B, LIGHT GRAY	33482-8635	B-LG	GCP	PLR	M-B								8					13	14	15	16		SALEABLE			
KEY A, BLACK	33482-8636	A-BLK	GCP	PLR	M-B										10	11		13	14	15	16		SALEABLE			
KEY A, BLACK	33482-8637	A-BLK	GCP	PLR	M-B										10	11				15	16		SALEABLE			
KEY A, BLACK	33482-8638	A-BLK	GCP	PLR	M-B								8	9	10	11	12						SALEABLE			
KEY A, BLACK	33482-8639	A-BLK	GCP	PLR	M-B															15			SALEABLE			
KEY A, BLACK	33482-8640	A-BLK	GCP	PLR	M-B					5													SALEABLE			
KEY A, BLACK	33482-8641	A-BLK	GCP	PLR	M-B					5													SALEABLE			
KEY B, LIGHT GRAY	33482-8642	B-LG	GCP	PLR	M-B				4			6	7	8					12		14		SALEABLE			
KEY A, BLACK	33482-8643	A-BLK	GCP	PLR	M-B																15	16	SALEABLE			
KEY B, LIGHT GRAY	33482-8644	B-LG	GCP	PLR	M-B					4													SALEABLE			
KEY B, LIGHT GRAY	33482-8645	B-LG	GCP	PLR	M-B							6	7	8									SALEABLE			
KEY A, BLACK	33482-8646	A-BLK	GCP	PLR	M-B				4			6	7	8						12			SALEABLE			
KEY A, BLACK	33482-8647	A-BLK	GCP	PLR	M-B																	16	SALEABLE			
KEY A, BLACK	33482-8648	A-BLK	GCP	PLR	M-B				4										12				SALEABLE			
KEY B, LIGHT GRAY	33482-8649	B-LG	GCP	PLR	M-B																	16	SALEABLE			
KEY B, LIGHT GRAY	33482-8650	B-LG	GCP	PLR	M-B				4												14		SALEABLE			
KEY B, LIGHT GRAY	33482-8651	B-LG	GCP	PLR	M-B																14		SALEABLE			
KEY B, LIGHT GRAY	33482-8652	B-LG	GCP	PLR	M-B						6	7	8								14		SALEABLE			
KEY A, BLACK	33482-8653	A-BLK	GCP	PLR	M-B									9							15		SALEABLE			
KEY A, BLACK	33482-8654	A-BLK	GCP	PLR	M-B														12				SALEABLE			
KEY B, LIGHT GRAY	33482-8655	B-LG	GCP	PLR	M-B																14		SALEABLE			
KEY B, LIGHT GRAY	33482-8656	B-LG	GCP	PLR	M-B																14		SALEABLE			
KEY A, BLACK	33482-8657	A-BLK	GCP	PLR	M-B	1							7										SALEABLE			
KEY B, LIGHT GRAY	33482-8658	B-LG	GCP	PLR	M-B								6	7	8					12			SALEABLE			
KEY B, LIGHT GRAY	33482-8659	B-LG	GCP	PLR	M-B								6	7	8								SALEABLE			
KEY B, LIGHT GRAY	33482-8660	B-LG	GCP	PLR	M-B																14		SALEABLE			
KEY A, BLACK	33482-8661	A-BLK	GCP	PLR	M-B																		SALEABLE			
KEY B, LIGHT GRAY	33482-8662	B-LG	GCP	PLR	M-B				2		4															

MX150 2X8 BLADE SEALED ASSY MAT SEAL
BOM AND PIN OUT SHEET

ASSEMBLY DESCRIPTION	ASSEMBLY PART NUMBER	COMPONENT				BLOCKED TERMINALS																STATUS	COMMENTS	OPTIONAL ATTACHMENTS SOLD SEPERATELY		
		THE PRESENCE OF AN ABBREVIATION INDICATES THE PRESENCE OF THAT COMPONENT.				CAVITY WITH A NUMBER INDICATES BLOCKED TERMINAL POSITION CAVITY WITHOUT A NUMBER INDICATES OPEN TERMINAL POSITION																		BACKSHELL WITH RIBS	BACKSHELL WITHOUT RIBS	
		HOUSING KEY/COLOR	GROMMET CAP	PLR	MAT SEAL	1	2	3	4	5	6	7	8	9	10	11	12	13	14	15	16					
KEY A, BLACK	33482-8769	A-BLK	GCP	PLR	M-B	1			4	5	6		8				12	13	14		16	SALEABLE				
KEY A, BLACK	33482-8770	A-BLK	GCP	PLR	M-B	1	2		4	5	6		8	9	10		12	13	14	15	16	SALEABLE				
KEY A, BLACK	33482-8771	A-BLK	GCP	PLR	M-B	1			4		6	7	8		10			13	14	15		SALEABLE				
KEY A, BLACK	33482-8772	A-BLK	GCP	PLR	M-B										10			13	14	15	16	SALEABLE				
KEY A, BLACK	33482-8773	A-BLK	GCP	PLR	M-B	1	2	3	4	5	6					11	12					SALEABLE				
KEY A, BLACK	33482-8774	A-BLK	GCP	PLR	M-B										10					15		SALEABLE				
KEY A, BLACK	33482-8775	A-BLK	GCP	PLR	M-B								9	10						15	16	SALEABLE				
KEY A, BLACK	33482-8776	A-BLK	GCP	PLR	M-B			3	4				9	10						15	16	SALEABLE				
KEY A, YELLOW	33482-8777	A-YW	GCP	PLR	M-B																	SALEABLE				
KEY A, BLACK	33482-8778	A-BLK	GCP	PLR	M-B					5		8										SALEABLE				
KEY A, BLACK	33482-8779	A-BLK	GCP	PLR	M-B					5	6	7	8	9	10	11	12					SALEABLE				
KEY A, BLACK	33482-8780	A-BLK	GCP	PLR	M-B			3	4	5	6							13	14			SALEABLE				
KEY A, BLACK	33482-8781	A-BLK	GCP	PLR	M-B	1			4	5	6	7	8	9	10			13	14	15		SALEABLE				
KEY A, BLACK	33482-8782	A-BLK	GCP	PLR	M-B	1			4		6	7	8		10	11	12	13	14	15		SALEABLE				
KEY A, BLACK	33482-8783	A-BLK	GCP	PLR	M-B											11	12			15		SALEABLE				
KEY A, BLACK	33482-8784	A-BLK	GCP	PLR	M-B			3														SALEABLE				
KEY A, BLACK	33482-8785	A-BLK	GCP	PLR	M-B	1				5		7				11	12	13	14	15	16	SALEABLE				
KEY A, BLACK	33482-8786	A-BLK	GCP	PLR	M-B		2			5		7		9		11	12	13	14	15	16	SALEABLE				
KEY A, BLACK	33482-8787	A-BLK	GCP	PLR	M-B	1	2			5				9								SALEABLE				
KEY A, BLACK	33482-8788	A-BLK	GCP	PLR	M-B	1	2					7		9		11	12	13	14	15	16	SALEABLE				
KEY A, BLACK	33482-8789	A-BLK	GCP	PLR	M-B	1	2			5				9						15		SALEABLE				
KEY A, BLACK	33482-8790	A-BLK	GCP	PLR	M-B	1	2			5		7		9		11	12	13	14	15	16	SALEABLE				
KEY A, BLACK	33482-8791	A-BLK	GCP	PLR	M-B	1	2	3														SALEABLE				
KEY A, BLACK	33482-8792	A-BLK	GCP	PLR	M-B					5		7									16	SALEABLE				
KEY A, BLACK	33482-8793	A-BLK	GCP	PLR	M-B		2	3							10	11						SALEABLE				
KEY A, BLACK	33482-8794	A-BLK	GCP	PLR	M-B	1	2	3		5	6						12					SALEABLE				
KEY A, BLACK	33482-8795	A-BLK	GCP	PLR	M-B			3							10			13	14	15		SALEABLE				
KEY A, BLACK	33482-8796	A-BLK	GCP	PLR	M-B							7		9				14	15	16		SALEABLE				
KEY A, BLACK	33482-8797	A-BLK	GCP	PLR	M-B							7	8				12					SALEABLE				
KEY A, BLACK	33482-8798	A-BLK	GCP	PLR	M-B			3							10	11	12	13	14	15	16	SALEABLE				
KEY A, BLACK	33482-8799	A-BLK	GCP	PLR	M-B										10				15	16		SALEABLE				
KEY A, BLACK	33482-8800	A-BLK	GCP	PLR	M-B	1	2			5								13	14			SALEABLE				
KEY A, BLACK	33482-8801	A-BLK	GCP	PLR	M-B					5		7	8	9	10	11	12	13	14			SALEABLE				
KEY A, BLACK	33482-8802	A-BLK	GCP	PLR	M-B					5								13	14			SALEABLE				
KEY A, BLACK	33482-8803	A-BLK	GCP	PLR	M-B	1	2			5												SALEABLE				
KEY A, BLACK	33482-8804	A-BLK	GCP	PLR	M-B	1	2			5		7	8	9	10	11	12	13	14			SALEABLE				
KEY A, BLACK	33482-8805	A-BLK	GCP	PLR	M-B						6				10	11	12	13	14	15	16	SALEABLE				
KEY A, BLACK	33482-8806	A-BLK	GCP	PLR	M-B					6								13	14	15	16	SALEABLE				
KEY A, BLACK	33482-8807	A-BLK	GCP	PLR	M-B					6								13	14			SALEABLE				
KEY A, BLACK	33482-8808	A-BLK	GCP	PLR	M-B	1	2	3	4	5	6						13	14	15	16		SALEABLE				
KEY A, BLACK	33482-8809	A-BLK	GCP	PLR	M-B	1							8							15		SALEABLE				
KEY A, BLACK	33482-8810	A-BLK	GCP	PLR	M-B	1														15		SALEABLE				
KEY A, BLACK	33482-8811	A-BLK	GCP	PLR	M-B								8								16	SALEABLE				
KEY A, BLACK	33482-8812	A-BLK	GCP	PLR	M-B								8			11	12	13			16	SALEABLE				
KEY A, BLACK	33482-8813	A-BLK	GCP	PLR	M-B				4	5	6	7	8		10				14	15	16	SALEABLE				
KEY A, BLACK	33482-8814	A-BLK	GCP	PLR	M-B										10							SALEABLE				
KEY A, BLACK	33482-8815	A-BLK	GCP	PLR	M-B	1		3		5	6	7					12	13				SALEABLE				
KEY A, BLACK	33482-8816	A-BLK	GCP	PLR	M-B			3		5	6	7			10			13	14	15	16	SALEABLE				
KEY A, BLACK	33482-8817	A-BLK	GCP	PLR	M-B											11	12		14	15	16	SALEABLE				
KEY A, BLACK	33482-8818	A-BLK	GCP	PLR	M-B					6	7	8			10	11	12	13	14	15		SALEABLE				
KEY A, BLACK	33482-8819	A-BLK	GCP	PLR	M-B	1	2					7		9	10	11	12	13	14	15	16	SALEABLE				
KEY A, BLACK	33482-8820	A-BLK	GCP	PLR	M-B		2					7		9			12	13	14		16	SALEABLE				
KEY A, BLACK	33482-8821	A-BLK	GCP	PLR	M-B		2	3				7		9	10	11			15	16		SALEABLE				
KEY A, BLACK	33482-8822	A-BLK	GCP	PLR	M-B	1			4	5	6		8				12	13	14		16	SALEABLE				
KEY A, BLACK	33482-8823	B-LG	GCP	PLR	M-B					5	6		9				12	13	14	15		SALEABLE				
KEY A, BLACK	33482-8824	A-BLK	GCP	PLR	M-B							7	8									SALEABLE				
KEY A, BLACK	33482-8825	A-BLK	GCP	PLR	M-B										10			13	14	15	16	SALEABLE				
KEY A, BLACK	33482-8826	A-BLK	GCP	PLR	M-B	1	2	3	4	5	6					11	12					SALEABLE				
KEY A, BLACK	33482-8827	A-BLK	GCP	PLR	M-B			3	4		6	7		9							16	SALEABLE				
KEY A, BLACK	33482-8828	A-BLK	GCP	PLR	M-B						6	7		9							16	SALEABLE				
KEY A, BLACK	33482-8829	A-BLK	GCP	PLR	M-B	1	2		4	5		7	8	9						15	16	SALEABLE				
KEY A, BLACK	33482-8830	A-BLK	GCP	PLR	M-B											11	12	13	14	15		SALEABLE				
KEY A, BLACK	33482-8831	A-BLK	GCP	PLR	M-B												12	13	14			SALEABLE				
KEY B, LIGHT GRAY	33482-8832	B-LG	GCP	PLR	M-B														14	15		SALEABLE				
KEY A, BLACK	33482-8833	A-BLK	GCP	PLR	M-B		2						8		10	11				15	16	SALEABLE				
KEY A, BLACK	33482-8834	A-BLK	GCP	PLR	M-B										10	11					15	SALEABLE				
KEY A, BLACK	33482-8835	A-BLK	GCP	PLR	M-B	1							8		10	11					15	SALEABLE				
KEY A, BLACK	33482-8836	A-BLK	GCP	PLR	M-B	1	2	3	4	5	6	7	8		10	11					15	SALEABLE				
KEY A, BLACK	33482-8837	A-BLK	GCP	PLR	M-B	1							8	9	10	11					15	16	SALEABLE			
KEY A, BLACK	33482-8838	A-BLK	GCP	PLR	M-B																15	16	SALEABLE			
KEY A, BLACK	33482-8839	A-BLK	GCP	PLR	M-B	1	2	3	4	5	6	7	8									SALEABLE				
KEY A, BLACK	33482-8840	A-BLK	GCP	PLR	M-B	1																SALEABLE				
KEY A, BLACK	33482-8841	A-BLK	GCP	PLR	M-B	1	2	3	4	5	6	7	8			11					16	SALEABLE				
KEY A, BLACK	33482-8842	A-BLK	GCP	PLR	M-B	1			4	5	6	7										SALEABLE				
KEY A, BLACK	33482-8843	A-BLK	GCP	PLR	M-B	1			4	5	6	7	8			11						SALEABLE				
KEY A, BLACK	33482-8844	A-BLK	GCP	PLR	M-B													13				16	SALEABLE			
KEY A, BLACK	33482-8845	A-BLK	GCP	PLR	M-B											11	12	13				16	SALEABLE			
KEY A, BLACK	334																									

MX150 2X8 BLADE SEALED ASSY MAT SEAL
BOM AND PIN OUT SHEET

ASSEMBLY DESCRIPTION	ASSEMBLY PART NUMBER	COMPONENT				BLOCKED TERMINALS																STATUS	COMMENTS	OPTIONAL ATTATCHMENTS SOLD SEPERATELY		
		THE PRESENCE OF AN ABBREVIATION INDICATES THE PRESENCE OF THAT COMPONENT.				CAVITY WITH A NUMBER INDICATES BLOCKED TERMINAL POSITION CAVITY WITHOUT A NUMBER INDICATES OPEN TERMINAL POSITION																		BACKSHELL WITH RIBS	BACKSHELL WITHOUT RIBS	
		HOUSING KEY/COLOR	GROMMET CAP	PLR	MAT SEAL	1	2	3	4	5	6	7	8	9	10	11	12	13	14	15	16					
KEY A, BLACK	33482-8858	A-BLK	GCP	PLR	M-B	1	2	3	4		6	7	8	9	10			13	14		16	SALEABLE				
KEY A, BLACK	33482-8859	A-BLK	GCP	PLR	M-B		2				5	7		9	10	11	12	13	14		16	SALEABLE				
KEY A, BLACK	33482-8860	A-BLK	GCP	PLR	M-B										10	11	12	13			16	SALEABLE				

