

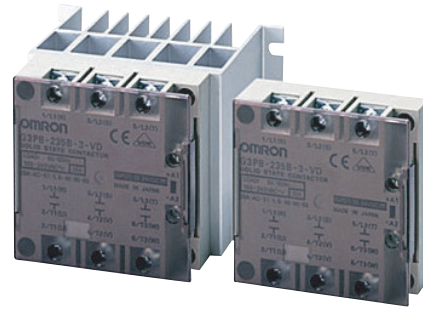

Compact, Low-cost Solid State Contactors of an Innovative Construction Ideal for Three-phase Heaters

- Slim Units with three-phase output.
- Optimum heat sinks attach to models without built-in heat sinks.
- Compact design achieved by optimizing heat sink shape.
- DIN track mounting possible (when using the Y92B-P50 Heat Sink) in addition to screw mounting.
- Comply with EN60947-4-3 (IEC947-4-3) UL508, and CSA22.2 No. 14, and bear CE marking.



 Refer to *Safety Precautions for All Solid State Relays*.

Model Number Structure

■ Model Number Legend

G3PB-□□□-□□□-□
 1 2 3 4 5 6 7

1. Basic Model Name

G3PB: Solid State Relay

2. Rated Load Power Supply Voltage

2: 200 VAC

4: 400 VAC

3. Rated Load Current

15: 15 A

25: 25 A

35: 35 A

45: 45 A

4. Terminal Type

B: Screw terminals

5. Single-phase/3-phase and Number of Elements for 3-phase

2: 3-phase, 2-element models

3: 3-phase, 3-element models

6. 3-phase Type

Blank: Built-in heat sink

H: No heat sink ("hockey puck" type)

7. Certification

VD: Certified by UL, CSA, and VDE

Ordering Information

■ List of Models

Models with Built-in Heat Sinks

Number of phases	Main circuit voltage	Zero cross function	Applicable load current (with Class-1 AC resistive load)	Number of elements	Model
3	100 to 240 VAC	Yes	15 A max.	3	G3PB-215B-3-VD
				2	G3PB-215B-2-VD
			25 A max.	3	G3PB-225B-3-VD
				2	G3PB-225B-2-VD
			35 A max.	3	G3PB-235B-3-VD
				2	G3PB-235B-2-VD
			45 A max.	3	G3PB-245B-3-VD
				2	G3PB-245B-2-VD
	200 to 400 VAC		15 A max.	3	G3PB-415B-3-VD
				2	G3PB-415B-2-VD
			25 A max.	3	G3PB-425B-3-VD
				2	G3PB-425B-2-VD
			35 A max.	3	G3PB-435B-3-VD
				2	G3PB-435B-2-VD
			45 A max.	3	G3PB-445B-3-VD
				2	G3PB-445B-2-VD

Note: 1. The applicable load current depends on the ambient temperature. For details, refer to *Load Current vs. Ambient Temperature* in, *Engineering Data* on page 7.

2. When ordering, specify the rated input voltage.

Models without Built-in Heat Sinks

Number of phases	Main circuit voltage	Zero cross function	Applicable load current	Number of elements	Model
3	100 to 240 VAC	Yes	15 A max.	3	G3PB-215B-3H-VD
				2	G3PB-215B-2H-VD
			25 A max.	3	G3PB-225B-3H-VD
				2	G3PB-225B-2H-VD
			35 A max.	3	G3PB-235B-3H-VD
				2	G3PB-235B-2H-VD
			45 A max.	3	G3PB-245B-3H-VD
				2	G3PB-245B-2H-VD
	200 to 400 VAC		15 A max.	3	G3PB-415B-3H-VD
				2	G3PB-415B-2H-VD
			25 A max.	3	G3PB-425B-3H-VD
				2	G3PB-425B-2H-VD
			35 A max.	3	G3PB-435B-3H-VD
				2	G3PB-435B-2H-VD
			45 A max.	3	G3PB-445B-3H-VD
				2	G3PB-445B-2H-VD

Note: 1. The applicable load current depends on the heat sink that is connected and the ambient temperature. For details, refer to *Load Current vs. Ambient Temperature* in, *Engineering Data* on page 7.

2. When ordering, specify the rated input voltage.

Heat Sinks

Heat resistance (°C/W)	Model
1.67	Y92B-P50
1.01	Y92B-P100
0.63	Y92B-P150
0.43	Y92B-P200
0.36	Y92B-P250

■ Accessories (Order Separately)

Mounting Track	Dimensions	Model
	50 cm (1) x 7.3 mm (t)	PFP-50N
	1 m (1) x 7.3 mm (t)	PFP-100N
	1 m (1) x 16 mm (t)	PFP-100N2

Specifications

■ Ratings (at an Ambient Temperature of 25°C)

Operating Circuit (Common)

Item	Common
Rated voltage	12 to 24 VDC
Operating voltage range	9.6 to 30 VDC
Rated input current	10 mA max. (at 24 VDC)
Must operate voltage	9.6 VDC max.
Must release voltage	1 VDC min.
Insulation method	Phototriac
Operation indicator	Yellow LED

Main Circuit of Models with Built-in Heat Sinks

Item	G3PB-215B-3-VD	G3PB-215B-2-VD	G3PB-225B-3-VD	G3PB-225B-2-VD	G3PB-235B-3-VD	G3PB-235B-2-VD	G3PB-245B-3-VD	G3PB-245B-2-VD
Rated load voltage	100 to 240 VAC							
Load voltage range	75 to 264 VAC							
Applicable load current (See note.)	0.2 to 15 A at 40°C		0.2 to 25 A at 40°C		0.5 to 35 A at 25°C		0.5 to 45 A at 25°C	
Inrush current resistance (peak value)	150 A (60 Hz, 1 cycle)		220 A (60 Hz, 1 cycle)		440 A (60 Hz, 1 cycle)			
Permissible I ² t (half 60-Hz wave)	121 A ² s		260 A ² s		1260 A ² s			
Applicable load (with Class-1 AC resistive load)	5.1 kW max. (at 200 VAC)		8.6 kW (at 200 VAC)		12.1 kW max. (at 200 VAC)		15.5 kW max. (at 200 VAC)	

Item	G3PB-415B-3-VD	G3PB-415B-2-VD	G3PB-425B-3-VD	G3PB-425B-2-VD	G3PB-435B-3-VD	G3PB-435B-2-VD	G3PB-445B-3-VD	G3PB-445B-2-VD
Rated load voltage	200 to 400 VAC							
Load voltage range	180 to 440 VAC							
Applicable load current (See note.)	0.5 to 15 A at 40°C		0.5 to 25 A at 40°C		0.5 to 35 A at 25°C		0.5 to 45 A at 25°C	
Inrush current resistance (peak value)	220 A (60 Hz, 1 cycle)				440 A (60 Hz, 1 cycle)			
Permissible I ² t (half 60-Hz wave)	260 A ² s		260 A ² s		1260 A ² s			
Applicable load (with Class-1 AC resistive load)	10.3 kW max. (at 400 VAC)		17.3 kW max. (at 400 VAC)		24.2 kW max. (at 400 VAC)		31.1 kW max. (at 400 VAC)	

Note: The applicable load current depends on the ambient temperature. For details, refer to *Load Current vs. Ambient Temperature* in, *Engineering Data* on page 7.

Main Circuit of Models without Built-in Heat Sinks

Item	G3PB-215B-3H-VD	G3PB-215B-2H-VD	G3PB-225B-3H-VD	G3PB-225B-2H-VD	G3PB-235B-3H-VD	G3PB-235B-2H-VD	G3PB-245B-3H-VD	G3PB-245B-2H-VD
Rated load voltage	100 to 240 VAC							
Load voltage range	75 to 264 VAC							
Applicable load current (See note.)	0.2 to 15 A at 40°C		0.2 to 25 A at 40°C		0.2 to 35 A at 25°C		0.2 to 45 A at 25°C	
Inrush current resistance (peak value)	150 A (60 Hz, 1 cycle)		220 A (60 Hz, 1 cycle)		440 A (60 Hz, 1 cycle)			
Permissible I ² t (half 60-Hz wave)	121 A ² s		260 A ² s		1260 A ² s			
Applicable load (with Class-1 AC resistive load)	The applicable load varies with the heat radiation of the Unit. Refer to page 7, <i>Engineering Data</i> for details.							

Item	G3PB-415B-3H-VD	G3PB-415B-2H-VD	G3PB-425B-3H-VD	G3PB-425B-2H-VD	G3PB-435B-3H-VD	G3PB-435B-2H-VD	G3PB-445B-3H-VD	G3PB-445B-2H-VD
Rated load voltage	200 to 400 VAC							
Load voltage range	180 to 440 VAC							
Applicable load current (See note.)	0.5 to 15 A at 40°C		0.5 to 25 A at 40°C		0.5 to 35 A at 25°C		0.5 to 45 A at 25°C	
Inrush current resistance (peak value)	220 A (60 Hz, 1 cycle)				440 A (60 Hz, 1 cycle)			
Permissible I ² t (half 60-Hz wave)	260 A ² s		260 A ² s		1260 A ² s			
Applicable load (with Class-1 AC resistive load)	Refer to page 7, <i>Engineering Data</i> for details.							

Note: The applicable load current depends on the heat sink that is connected and the ambient temperature. For details, refer to *Load Current vs. Ambient Temperature* in, *Engineering Data* on page 7.

■ Characteristics

Models with Built-in Heat Sinks

Item	G3PB-215B-3-VD	G3PB-215B-2-VD	G3PB-225B-3-VD	G3PB-225B-2-VD	G3PB-235B-3-VD	G3PB-235B-2-VD	G3PB-245B-3-VD	G3PB-245B-2-VD
Operate time	1/2 of load power source cycle + 1 ms max. (DC input)							
Release time	1/2 of load power source cycle + 1 ms max. (DC input)							
Output ON voltage drop	1.6 V (RMS) max.							
Leakage current (See note.)	10 mA (at 200 VAC)							
Insulation resistance	100 MΩ min. (at 500 VDC)							
Dielectric strength	2,500 VAC, 50/60 Hz for 1 min							
Vibration resistance	Destruction: 10 to 55 to 10 Hz, 0.375-mm single amplitude (Mounted to DIN track)							
Shock resistance	Destruction: 294 m/s ²							
Ambient temperature	Operating: -30°C to 80°C (with no icing or condensation) Storage: -30°C to 100°C (with no icing or condensation)							
Ambient humidity	Operating: 45% to 85%							
Weight	Approx. 750 g	Approx. 750 g	Approx. 900 g	Approx. 750 g	Approx. 1,150 g	Approx. 900 g	Approx. 1,500 g	Approx. 1,150 g
Certified standards	UL508, CSA22.2 No. 14, EN60947-4-3 (IEC947-4-3) (From April 1999)							
EMC	Emission: EN55011 Group 1 Class B Immunity: EN61000-6-2							

Note: The leakage current of phase S will be approximately $\sqrt{3}$ times larger if the 2-element model is applied.

Item	G3PB-415B-3-VD	G3PB-415B-2-VD	G3PB-425B-3-VD	G3PB-425B-2-VD	G3PB-435B-3-VD	G3PB-435B-2-VD	G3PB-445B-3-VD	G3PB-445B-2-VD
Operate time	1/2 of load power source cycle + 1 ms max. (DC input)							
Release time	1/2 of load power source cycle + 1 ms max. (DC input)							
Output ON voltage drop	1.8 V (RMS) max.							
Leakage current (See note.)	20 mA (at 400 VAC)							
Insulation resistance	100 MΩ min. (at 500 VDC)							
Dielectric strength	2,500 VAC, 50/60 Hz for 1 min							
Vibration resistance	Destruction: 10 to 55 to 10 Hz, 0.375-mm single amplitude (Mounted to DIN track)							
Shock resistance	Destruction: 294 m/s ²							
Ambient temperature	Operating: -30°C to 80°C (with no icing or condensation) Storage: -30°C to 100°C (with no icing or condensation)							
Ambient humidity	Operating: 45% to 85%							
Weight	Approx. 750 g	Approx. 750 g	Approx. 900 g	Approx. 750 g	Approx. 1,150 g	Approx. 900 g	Approx. 1,500 g	Approx. 1,150 g
Certified standards	UL508, CSA22.2 No. 14, EN60947-4-3 (IEC947-4-3)							
EMC	Emission: EN55011 Group 1 Class B Immunity: EN61000-6-2							

Note: The leakage current of phase S will be approximately $\sqrt{3}$ times larger if the 2-element model is applied.

Models without Built-in Heat Sinks

Item	G3PB-215B-3H-VD	G3PB-215B-2H-VD	G3PB-225B-3H-VD	G3PB-225B-2H-VD	G3PB-235B-3H-VD	G3PB-235B-2H-VD	G3PB-245B-3H-VD	G3PB-245B-2H-VD
Operate time	1/2 of load power source cycle + 1 ms max. (DC input)							
Release time	1/2 of load power source cycle + 1 ms max. (DC input)							
Output ON voltage drop	1.6 V (RMS) max.							
Leakage current (See note.)	10 mA (at 200 VAC)							
Insulation resistance	100 MΩ min. (at 500 VDC)							
Dielectric strength	2,500 VAC, 50/60 Hz for 1 min							
Vibration resistance	Destruction: 10 to 55 to 10 Hz, 0.375-mm single amplitude							
Shock resistance	Destruction: 294 m/s ²							
Ambient temperature	Operating: -30°C to 80°C (with no icing or condensation) Storage: -30°C to 100°C (with no icing or condensation)							
Ambient humidity	Operating: 45% to 85%							
Certified standards	UL508, CSA22.2 No. 14, EN60947-4-3 (IEC947-4-3)							
Weight (Max.)	300 g max.							
EMC	Emission: EN55011 Group 1 Class B Immunity: EN61000-6-2							

Note: The leakage current of phase S will be approximately $\sqrt{3}$ times larger if the 2-element model is applied.

Item	G3PB-415B-3H-VD	G3PB-415B-2H-VD	G3PB-425B-3H-VD	G3PB-425B-2H-VD	G3PB-435B-3H-VD	G3PB-435B-2H-VD	G3PB-445B-3H-VD	G3PB-445B-2H-VD
Operate time	1/2 of load power source cycle + 1 ms max. (DC input)							
Release time	1/2 of load power source cycle + 1 ms max. (DC input)							
Output ON voltage drop	1.8 V (RMS) max.							
Leakage current (See note.)	20 mA (at 400 VAC)							
Insulation resistance	100 MΩ min. (at 500 VDC)							
Dielectric strength	2,500 VAC, 50/60 Hz for 1 min							
Vibration resistance	Destruction: 10 to 55 to 10 Hz, 0.375-mm single amplitude							
Shock resistance	Destruction: 294 m/s ²							
Ambient temperature	Operating: -30°C to 80°C (with no icing or condensation) Storage: -30°C to 100°C (with no icing or condensation)							
Ambient humidity	Operating: 45% to 85%							
Certified standards	UL508, CSA22.2 No. 14, EN60947-4-3 (IEC947-4-3)							
Weight	Approx. 300 g							
EMC	Emission: EN55011 Group 1 Class B Immunity: EN61000-6-2							

Note: The leakage current of phase S will be approximately $\sqrt{3}$ times larger if the 2-element model is applied.

Heat Sinks

Model	Weight
Y92B-P50	Approx. 450 g
Y92B-P100	Approx. 450 g
Y92B-P150	Approx. 600 g
Y92B-P200	Approx. 850 g
Y92B-P250	Approx. 1,200 g

Engineering Data

Load Current vs. Ambient Temperature

Models with Built-in Heat Sinks

G3PB-215B-3-VD
G3PB-215B-2-VD

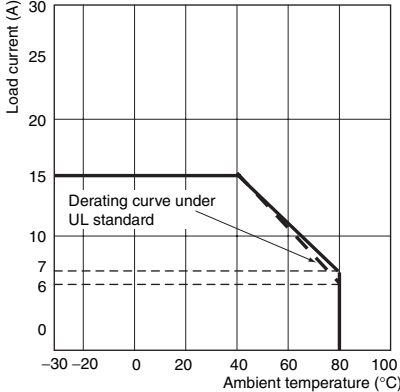

G3PB-225B-3-VD
G3PB-225B-2-VD

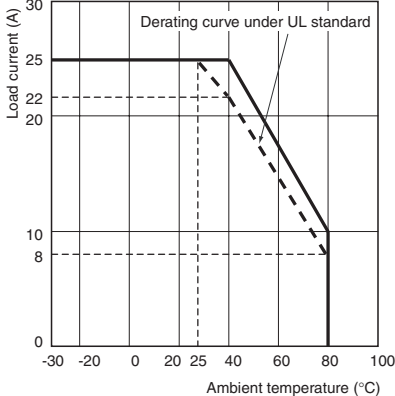

G3PB-235B-3-VD
G3PB-235B-2-VD

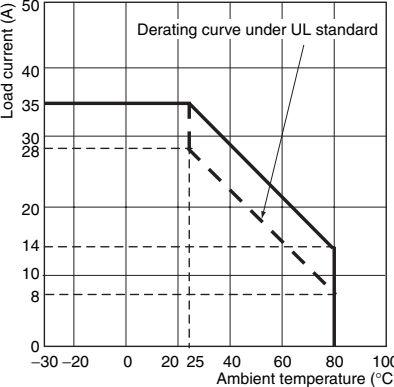

Note: 1. Please use proper ventilation and cooling.
 2. Please note that the derating curve above 28 A is applicable under the UL standard only with forced air cooling by fan.

G3PB-245B-3-VD
G3PB-245B-2-VD

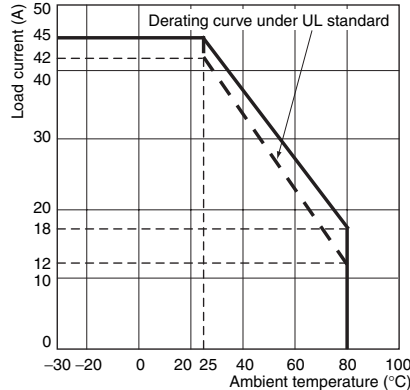

Note: 1. Please use proper ventilation and cooling.
 2. Please note that the derating curve above 42 A is applicable under the UL standard only with forced air cooling by fan.

G3PB-415B-3-VD
G3PB-415B-2-VD

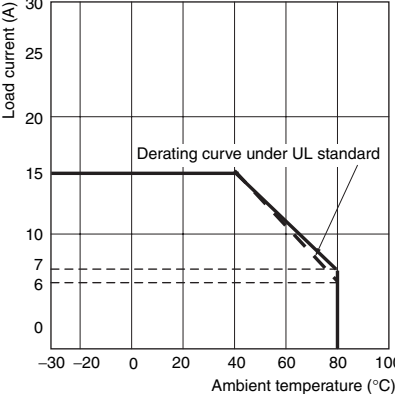

G3PB-425B-3-VD
G3PB-425B-2-VD

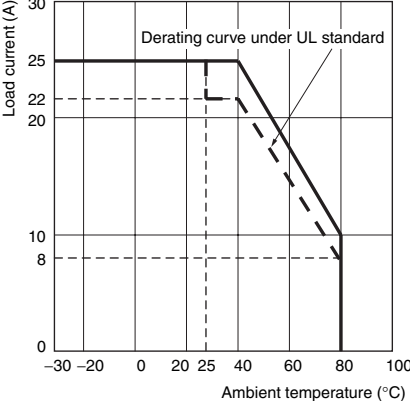

Note: 1. Please use proper ventilation and cooling.
 2. Please note that the derating curve above 22 A is applicable under the UL standard only with forced air cooling by fan.

G3PB-435B-3-VD
G3PB-435B-2-VD

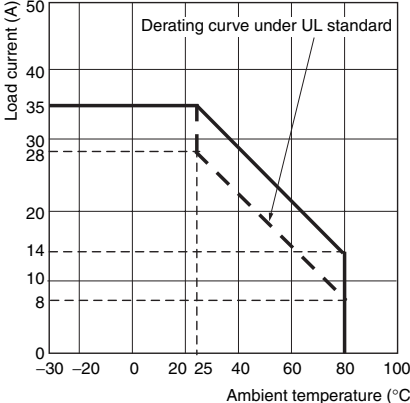

Note: 1. Please use proper ventilation and cooling.
 2. Please note that the derating curve above 28 A is applicable under the UL standard only with forced air cooling by fan.

G3PB-445B-3-VD
G3PB-445B-2-VD

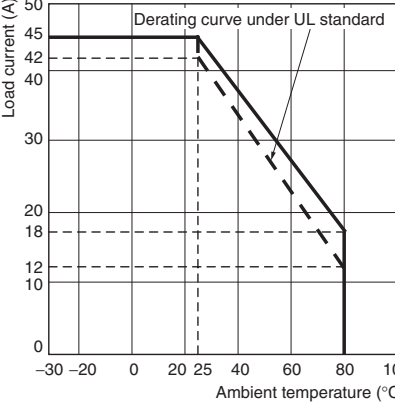

Note: 1. Please use proper ventilation and cooling.
 2. Please note that the derating curve above 42 A is applicable under the UL standard only with forced air cooling by fan.

Models without Built-in Heat Sinks

- | | | | |
|-----------------|-----------------|-----------------|-----------------|
| G3PB-215B-3H-VD | G3PB-225B-3H-VD | G3PB-235B-3H-VD | G3PB-435B-3H-VD |
| G3PB-215B-2H-VD | G3PB-225B-2H-VD | G3PB-235B-2H-VD | G3PB-435B-2H-VD |
| G3PB-415B-3H-VD | G3PB-425B-3H-VD | G3PB-245B-3H-VD | G3PB-445B-3H-VD |
| G3PB-415B-2H-VD | G3PB-425B-2H-VD | G3PB-245B-2H-VD | G3PB-445B-2H-VD |

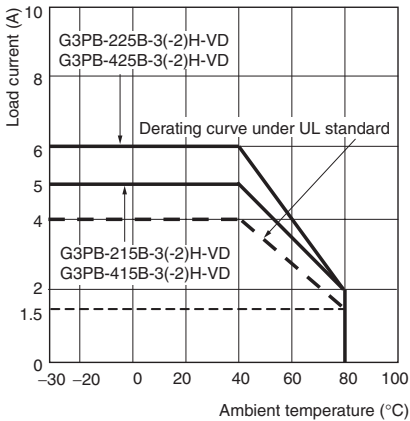

Note: Please use proper ventilation and cooling.

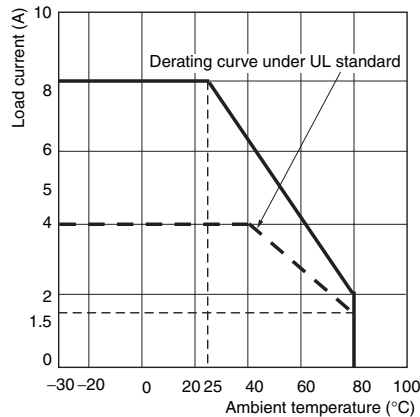

Note: Please use proper ventilation and cooling.

Input Voltage vs. Input Current and Input Voltage vs. Input Impedance

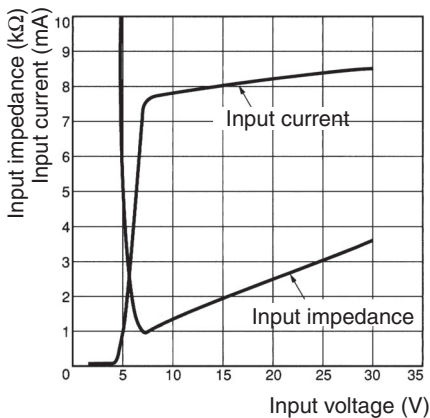

One Cycle Surge Current: Non-repetitive

Note: Keep the inrush current to half the rated value if it occurs repetitively.

- G3PB-215B-3 (H)-VD
G3PB-215B-2 (H)-VD

- G3PB-225B-3 (H)-VD G3PB-425B-3 (H)-VD
G3PB-225B-2 (H)-VD
G3PB-415B-3 (H)-VD G3PB-425B-2 (H)-VD
G3PB-415B-2 (H)-VD

- G3PB-235B-3 (H)-VD G3PB-435B-3 (H)-VD
G3PB-235B-2 (H)-VD G3PB-435B-2 (H)-VD
G3PB-245B-3 (H)-VD G3PB-445B-3 (H)-VD
G3PB-245B-2 (H)-VD G3PB-445B-2 (H)-VD

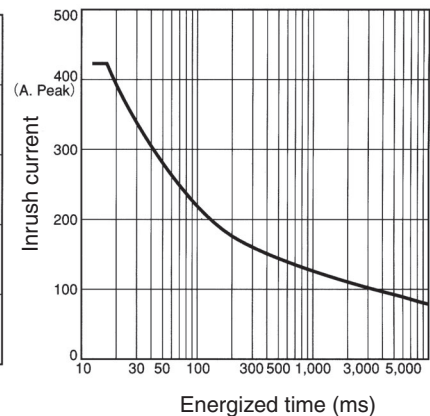
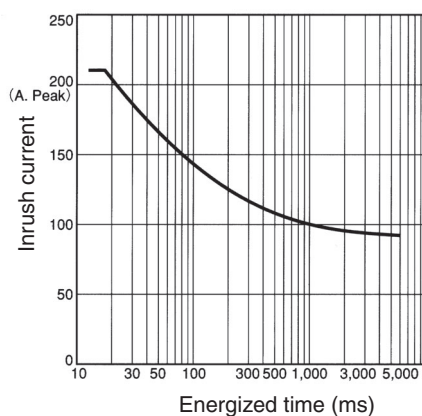
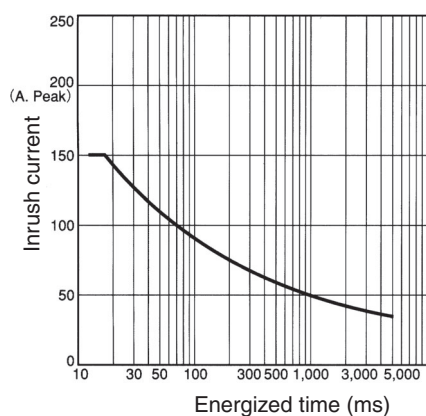

Heat Sink Area vs. Load Current

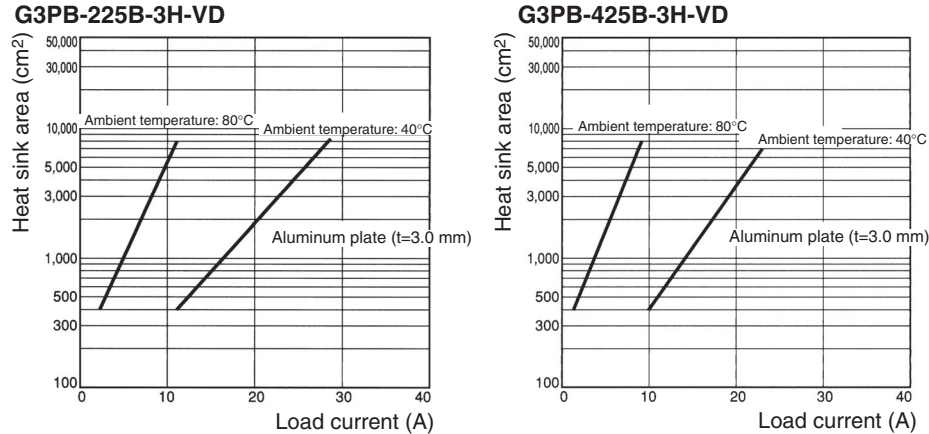

Note: The heat sink area refers to the combined area of the sides of the heat sink that radiate heat. In the case of G3PB-425B-3H-VD, when a current of 18 A is allowed to flow through the SSR at 40°C, the graph shows that the heat sink area is about 2,500 cm². Therefore, if the heat sink is square, one side of the heat sink must be 36 cm (36² × 2 = 2,592) or longer.

Thermal Resistance Rth (Junction/SSR Back Surface)

Three-phase Models without Heat Sink

Model	Rth (°C/W)
G3PB-215B-3H-VD	1.05
G3PB-225B-3H-VD	0.57
G3PB-235B-3H-VD	0.57
G3PB-245B-3H-VD	0.57

Dimensions

Note: All units are in millimeters unless otherwise indicated.

Models with Built-in Heat Sinks

G3PB-215B-2-VD
G3PB-415B-2-VD

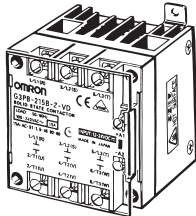

Without Terminal Cover

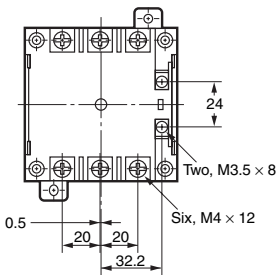

With Terminal Cover

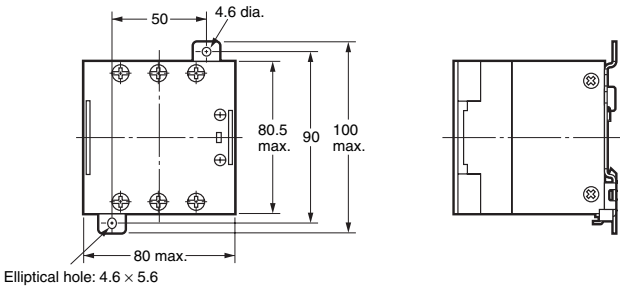

Mounting holes

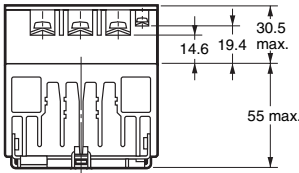
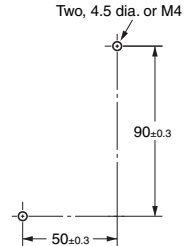

Terminal Arrangement/Internal Circuit Diagram

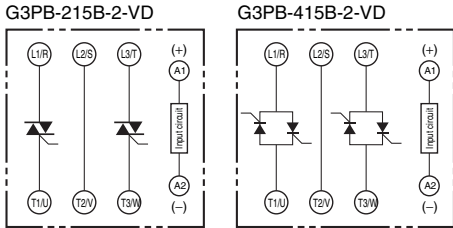

G3PB-215B-3-VD
G3PB-225B-2-VD
G3PB-415B-3-VD
G3PB-425B-2-VD

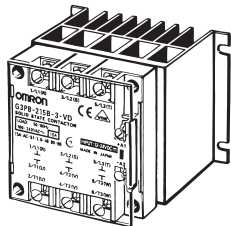

Without Terminal Cover

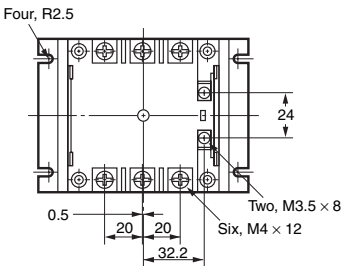

With Terminal Cover

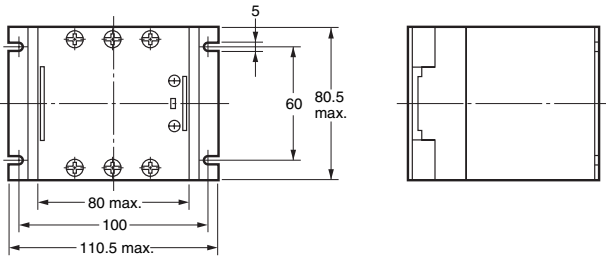

Mounting Holes

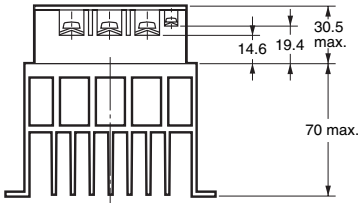
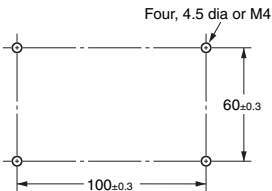

Terminal Arrangement/Internal Circuit Diagram

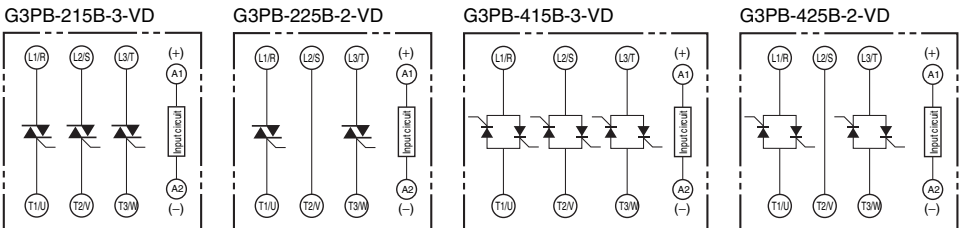

G3PB-225B-3-VD
 G3PB-235B-2-VD
 G3PB-425B-3-VD
 G3PB-435B-2-VD

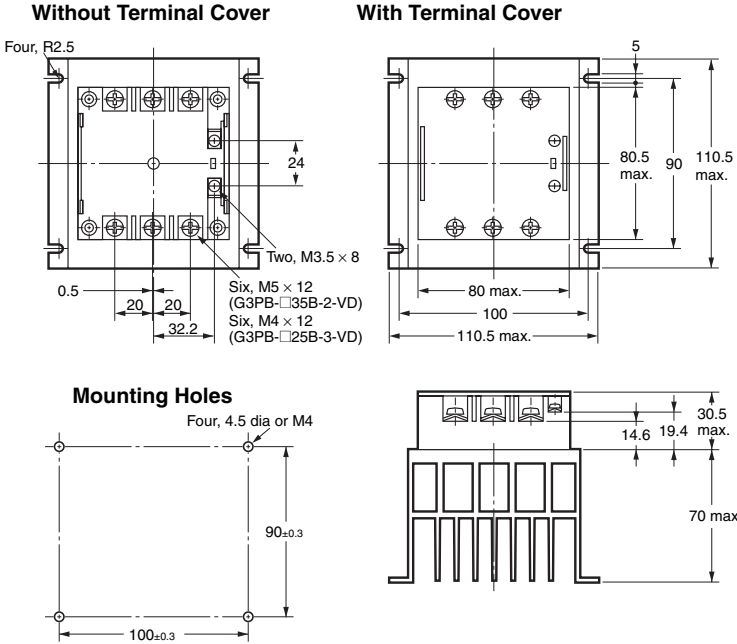
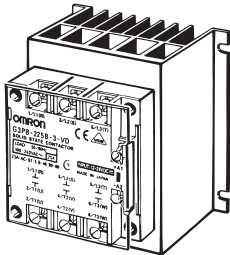

Terminal Arrangement/Internal Circuit Diagram

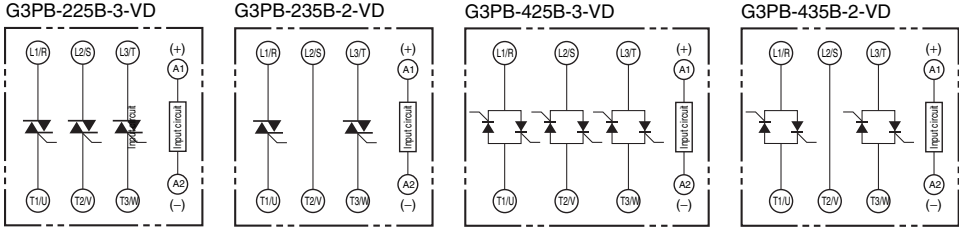

G3PB-235B-3-VD
 G3PB-245B-2-VD
 G3PB-435B-3-VD
 G3PB-445B-2-VD

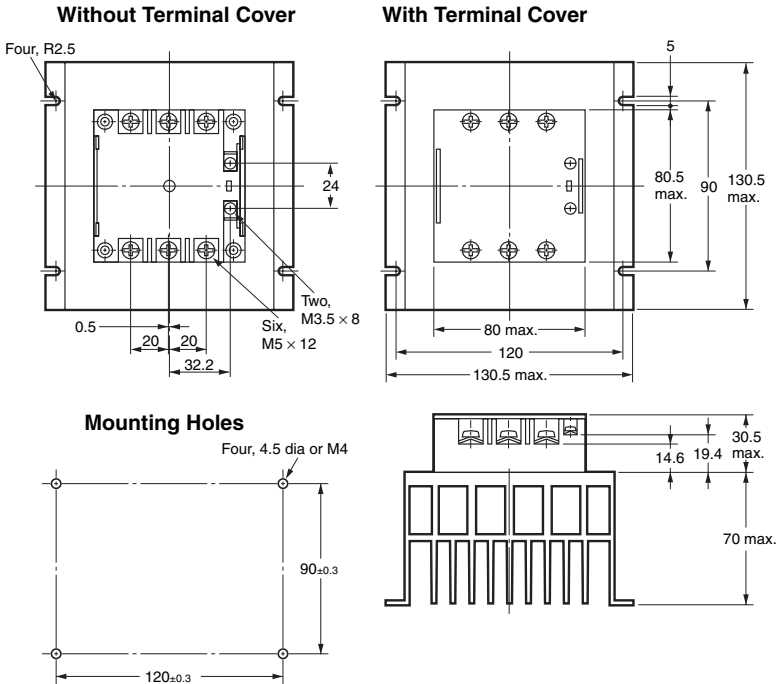
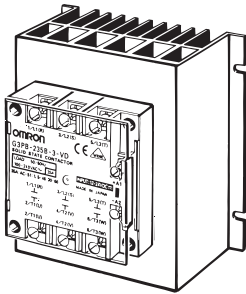

Terminal Arrangement/Internal Circuit Diagram

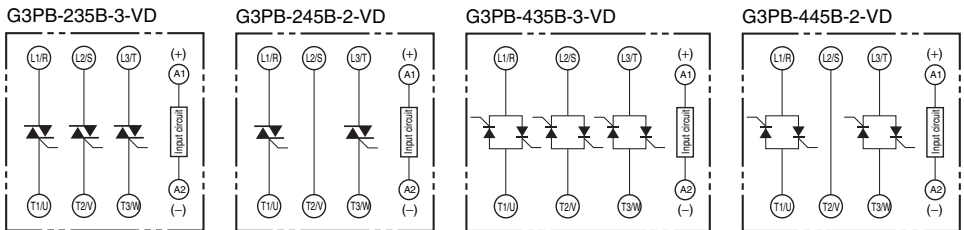

G3PB-245B-3-VD
G3PB-445B-3-VD

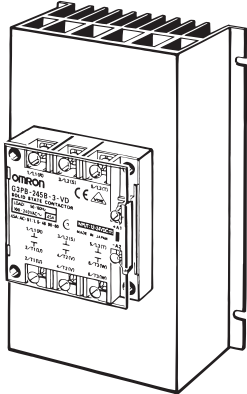

Without Terminal Cover

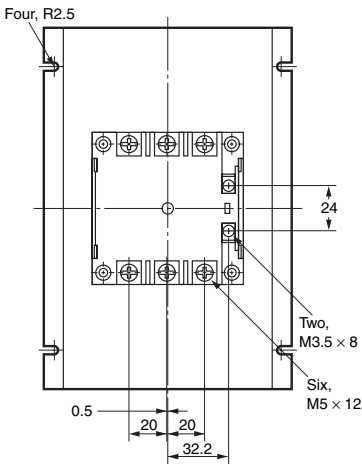

With Terminal Cover

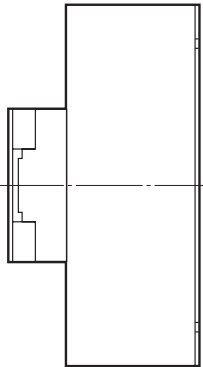
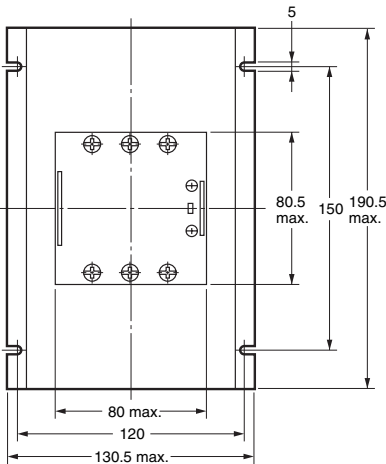

Mounting Holes

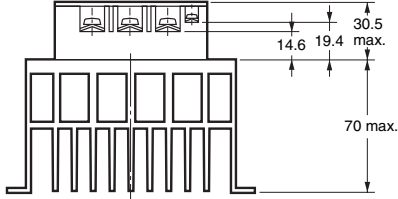
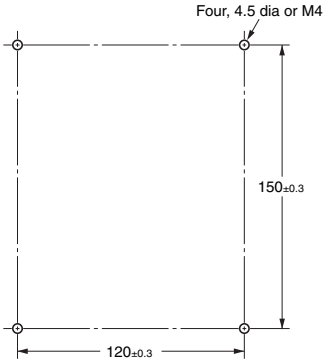

Terminal Arrangement/Internal Circuit Diagram

G3PB-245B-3-VD

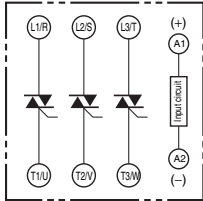

G3PB-445B-3-VD

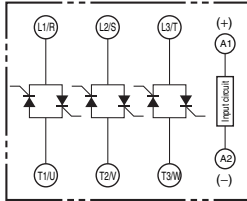

Models without Built-in Heat Sinks

- G3PB-215B-3H-VD
- G3PB-215B-2H-VD
- G3PB-225B-3H-VD
- G3PB-225B-2H-VD
- G3PB-235B-3H-VD
- G3PB-235B-2H-VD
- G3PB-245B-3H-VD
- G3PB-245B-2H-VD
- G3PB-415B-3H-VD
- G3PB-415B-2H-VD
- G3PB-425B-3H-VD
- G3PB-425B-2H-VD
- G3PB-435B-3H-VD
- G3PB-435B-2H-VD
- G3PB-445B-3H-VD
- G3PB-445B-2H-VD

Without Terminal Cover

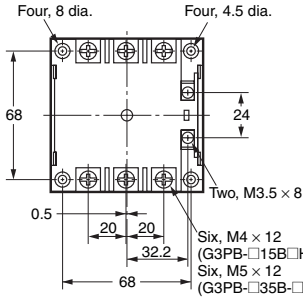

With Terminal Cover

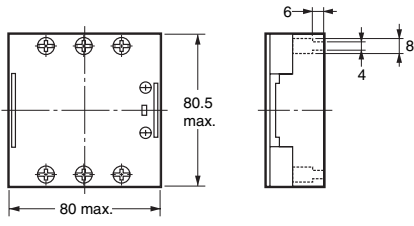

Mounting Holes

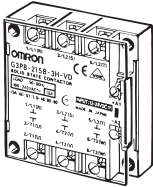
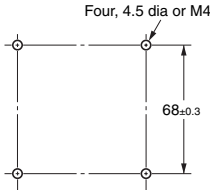

Terminal Arrangement/Internal Circuit Diagram

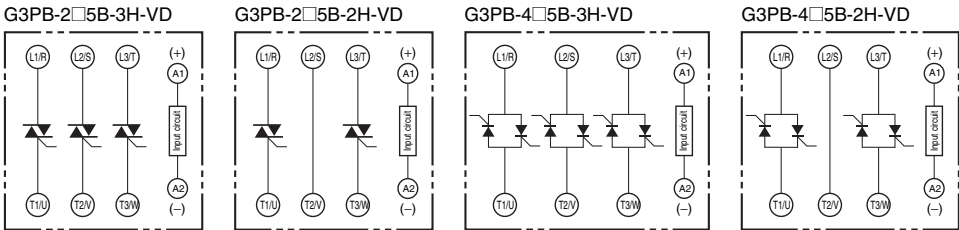

Heat Sinks

- Y92B-P50**
For model G3PB-215B-2H-VD
G3PB-415B-2H-VD

- Y92B-P100**
For G3PB-215B-3H-VD
G3PB-225B-2H-VD
G3PB-415B-3H-VD
G3PB-425B-2H-VD

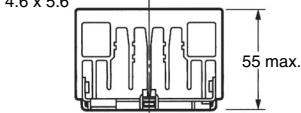
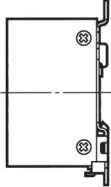
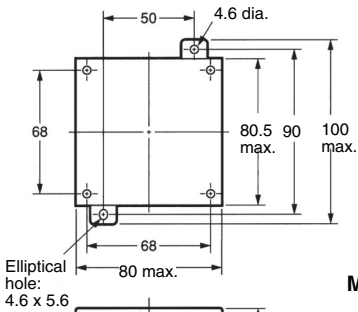

Mounting Holes

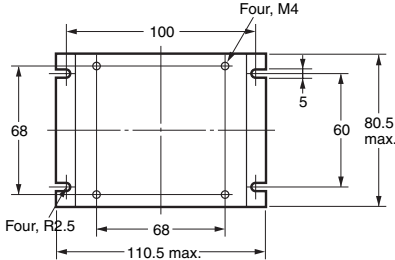
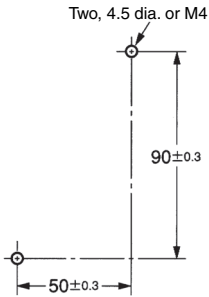

Mounting Holes

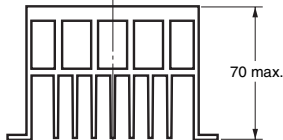
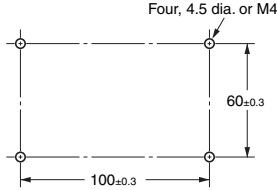

Y92B-P150

For model G3PB-225B-3H-VD
G3PB-235B-2H-VD
G3PB-425B-3H-VD
G3PB-435B-2H-VD

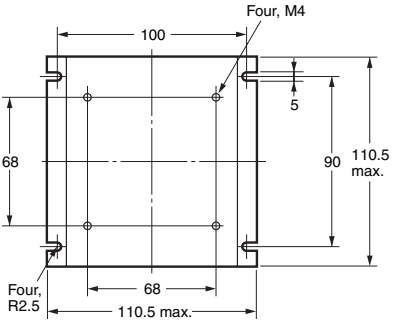

Y92B-P200

For model G3PB-235B-3H-VD
G3PB-245B-2H-VD
G3PB-435B-3H-VD
G3PB-445B-2H-VD

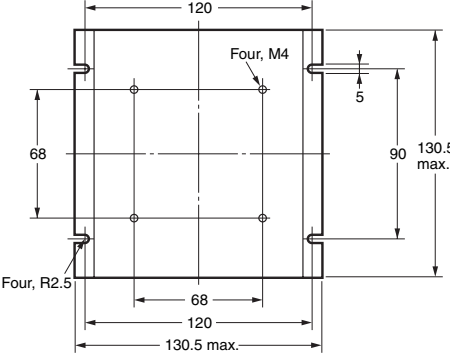

Y92B-P250

For model G3PB-245B-3-VD
G3PB-445B-3-VD

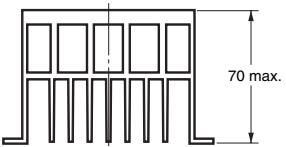
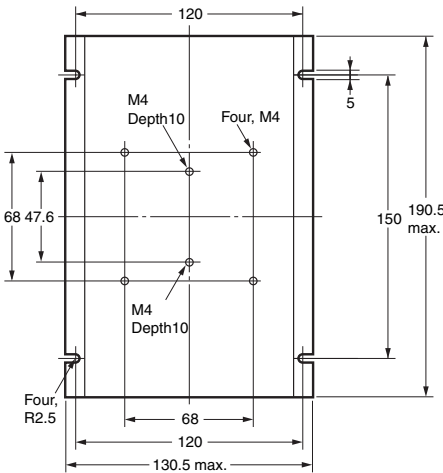

Mounting Holes

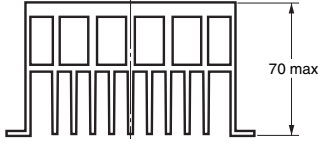
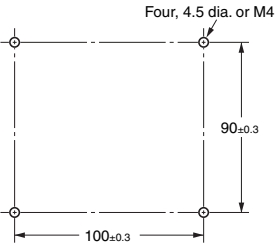

Mounting Holes

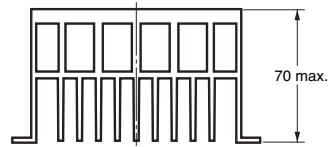
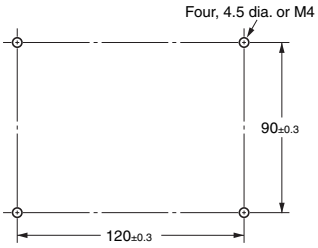

Mounting Holes

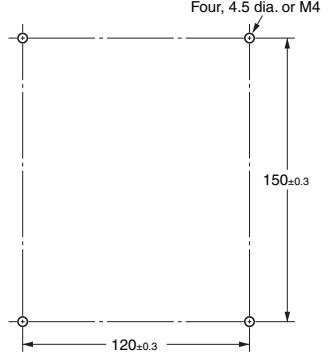

Accessories (Order Separately)

Mounting Tracks

PFP-100N, PFP-50N

PFP-100N2

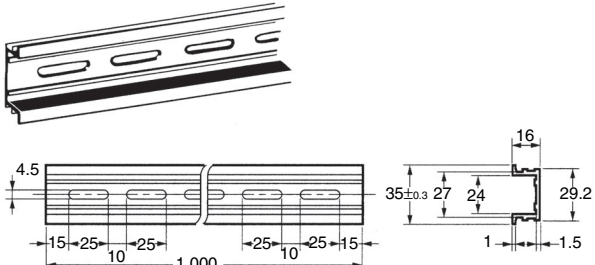
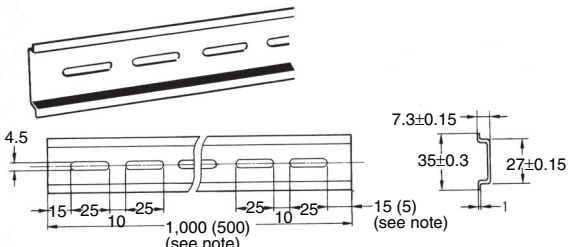

Note: Values in parentheses indicate dimensions for the PFP-50N.

ALL DIMENSIONS SHOWN ARE IN MILLIMETERS.
To convert millimeters into inches, multiply by 0.03937. To convert grams into ounces, multiply by 0.03527.

In the interest of product improvement, specifications are subject to change without notice.

Read and Understand This Catalog

Please read and understand this catalog before purchasing the products. Please consult your OMRON representative if you have any questions or comments.

Warranty and Limitations of Liability

WARRANTY

OMRON's exclusive warranty is that the products are free from defects in materials and workmanship for a period of one year (or other period if specified) from date of sale by OMRON.

OMRON MAKES NO WARRANTY OR REPRESENTATION, EXPRESS OR IMPLIED, REGARDING NON-INFRINGEMENT, MERCHANTABILITY, OR FITNESS FOR PARTICULAR PURPOSE OF THE PRODUCTS. ANY BUYER OR USER ACKNOWLEDGES THAT THE BUYER OR USER ALONE HAS DETERMINED THAT THE PRODUCTS WILL SUITABLY MEET THE REQUIREMENTS OF THEIR INTENDED USE. OMRON DISCLAIMS ALL OTHER WARRANTIES, EXPRESS OR IMPLIED.

LIMITATIONS OF LIABILITY

OMRON SHALL NOT BE RESPONSIBLE FOR SPECIAL, INDIRECT, OR CONSEQUENTIAL DAMAGES, LOSS OF PROFITS OR COMMERCIAL LOSS IN ANY WAY CONNECTED WITH THE PRODUCTS, WHETHER SUCH CLAIM IS BASED ON CONTRACT, WARRANTY, NEGLIGENCE, OR STRICT LIABILITY.

In no event shall the responsibility of OMRON for any act exceed the individual price of the product on which liability is asserted.

IN NO EVENT SHALL OMRON BE RESPONSIBLE FOR WARRANTY, REPAIR, OR OTHER CLAIMS REGARDING THE PRODUCTS UNLESS OMRON'S ANALYSIS CONFIRMS THAT THE PRODUCTS WERE PROPERLY HANDLED, STORED, INSTALLED, AND MAINTAINED AND NOT SUBJECT TO CONTAMINATION, ABUSE, MISUSE, OR INAPPROPRIATE MODIFICATION OR REPAIR.

Application Considerations

SUITABILITY FOR USE

OMRON shall not be responsible for conformity with any standards, codes, or regulations that apply to the combination of products in the customer's application or use of the products.

At the customer's request, OMRON will provide applicable third party certification documents identifying ratings and limitations of use that apply to the products. This information by itself is not sufficient for a complete determination of the suitability of the products in combination with the end product, machine, system, or other application or use.

The following are some examples of applications for which particular attention must be given. This is not intended to be an exhaustive list of all possible uses of the products, nor is it intended to imply that the uses listed may be suitable for the products:

- Outdoor use, uses involving potential chemical contamination or electrical interference, or conditions or uses not described in this catalog.
- Nuclear energy control systems, combustion systems, railroad systems, aviation systems, medical equipment, amusement machines, vehicles, safety equipment, and installations subject to separate industry or government regulations.
- Systems, machines, and equipment that could present a risk to life or property.

Please know and observe all prohibitions of use applicable to the products.

NEVER USE THE PRODUCTS FOR AN APPLICATION INVOLVING SERIOUS RISK TO LIFE OR PROPERTY WITHOUT ENSURING THAT THE SYSTEM AS A WHOLE HAS BEEN DESIGNED TO ADDRESS THE RISKS, AND THAT THE OMRON PRODUCTS ARE PROPERLY RATED AND INSTALLED FOR THE INTENDED USE WITHIN THE OVERALL EQUIPMENT OR SYSTEM.

PROGRAMMABLE PRODUCTS

OMRON shall not be responsible for the user's programming of a programmable product, or any consequence thereof.

Disclaimers

CHANGE IN SPECIFICATIONS

Product specifications and accessories may be changed at any time based on improvements and other reasons.

It is our practice to change model numbers when published ratings or features are changed, or when significant construction changes are made. However, some specifications of the products may be changed without any notice. When in doubt, special model numbers may be assigned to fix or establish key specifications for your application on your request. Please consult with your OMRON representative at any time to confirm actual specifications of purchased products.

DIMENSIONS AND WEIGHTS

Dimensions and weights are nominal and are not to be used for manufacturing purposes, even when tolerances are shown.

PERFORMANCE DATA

Performance data given in this catalog is provided as a guide for the user in determining suitability and does not constitute a warranty. It may represent the result of OMRON's test conditions, and the users must correlate it to actual application requirements. Actual performance is subject to the OMRON Warranty and Limitations of Liability.

ERRORS AND OMISSIONS

The information in this document has been carefully checked and is believed to be accurate; however, no responsibility is assumed for clerical, typographical, or proofreading errors, or omissions.

2008.11

In the interest of product improvement, specifications are subject to change without notice.

OMRON Corporation
Industrial Automation Company

<http://www.ia.omron.com/>

(c)Copyright OMRON Corporation 2008 All Right Reserved.