

59020 Miniature Firecracker Reed Sensor + 57020 Actuator

RoHS



Description

The 59020 Firecracker Reed Sensor is a miniature cylindrical reed sensor 15.24mm x 5.10mm (0.600" x 0.201") with a normally open contact. It is capable of switching up to 170Vdc at 10W. It has a variety of cable lengths and connector options. It functions best with the 57020-000 actuator.

Note: The 57020 Actuator is sold separately.

Features

- Magnetically operated proximity sensor
- Normally open contact
- Customer defined sensitivity option
- Choice of cable length and connector

Benefits

- Hermetically sealed, magnetically operated contacts continue to operate long after optical and other technologies fail due to contamination
- Quick and easy to install
- No standby power requirement
- Operates through non-ferrous materials such as wood, plastic or aluminium

Applications

- Position and Limit Sensing
- Security Systems
- Level Sensing
- Linear Actuators

Dimensions

Dimensions in mm (inch)

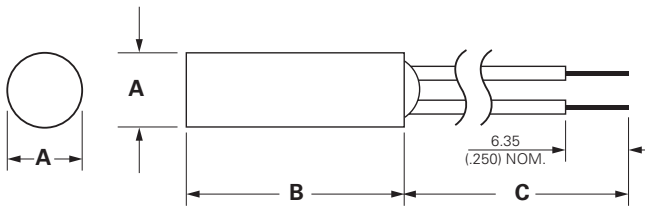

	A Nom.	B Nom.	C Nom.
57020 Actuator	5.10 (.201)	15.24 (.600)	–
59020 Sensor	5.10 (.201)	15.24 (.600)	300 (11.81)± 10.00 (.393)

59020 Miniature Firecracker Reed Sensor + 57020 Actuator

Electrical Ratings

Contact Type			Normally Open
Switch Type			1
Contact Rating ¹		VA/Watt - max.	10
Voltage ⁴	Switching ² Breakdown ³	Vdc - max.	170
		Vdc - min.	175
Current ⁴	Switching ² Carry	Adc - max.	0.25
		Adc - max.	0.5
Resistance ⁵	Contact, Initial Insulation	Ω - max.	0.2
		Ω - min.	10 ¹⁰
Capacitance	Contact	pF - typ.	0.2
Temperature	Operating	°C	-40 to +105

Product Characteristics

Operate Time ⁶		ms - max.	1.0
Release Time ⁶		ms - max.	1.0
Shock ⁷	11ms ½ sine	G - max.	100
Vibration ⁷	50-2000 Hz	G - max.	30

Notes:

- Contact rating - Product of the switching voltage and current should never exceed the wattage rating. Contact Littelfuse for additional load/life information.
- When switching inductive and/or capacitive loads, the effects of transient voltages and/or currents should be considered. Refer to Application Notes AN108A and AN107 for details.
- Breakdown Voltage - per MIL-STD-202, Method 301.
- Electrical Load Life Expectancy - Contact Littelfuse with voltage, current values along with type of load.
- This resistance value is for 11.81mm wire length. Resistance changes when wire lengthens.
- Operate (including bounce)/Release Time - per EIA/NARM RS-421-A, diode suppressed coil (Coil II).
- Shock and Vibration - per EIA/NARM RS-421-A and MIL-STD-202.
- For custom modifications to the wire length or size, or adding a special connector, please contact Littelfuse.

Sensitivity Options (Using 57020 Actuator)

Select Option		S	
Switch Type		Pull-In AT Range	Activate Distance – D mm (inch) Average
1	Normally Open	6-10	6.0 (.236)

Note:

- Pull-In AT Range: These AT values are the bare reed switch AT before modification.
- The activation distance is average value on the final sensor assembly.

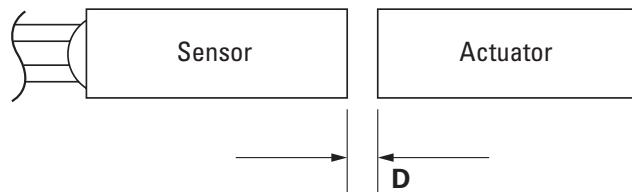

59020 Miniature Firecracker Reed Sensor + 57020 Actuator

Cable Length Specification

Cable Type: 24 AWG 7/32 PVC 105°C UL1430/UL1569	
Select Option	Cable Length mm (inch)
02	300 (11.81)

Termination Specification

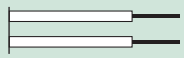
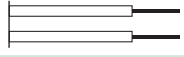
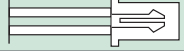
Termination Options		
Select Option	Description (Two-wire versions illustrated)	
A	Tinned leads (6.4±0.76)mm	
F	Untinned leads (6.4±0.76)mm	
E	JST type XHP 2.5mm pitch	

Part Numbering System

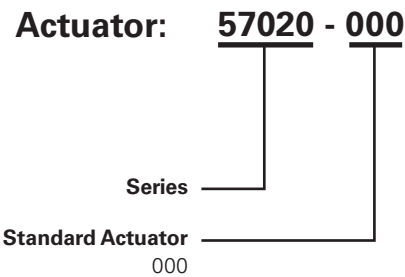
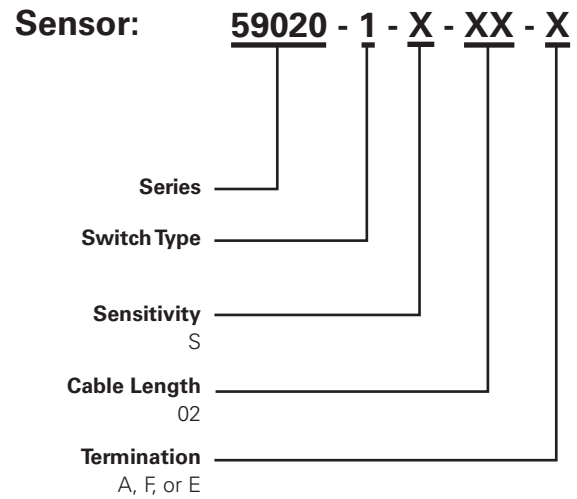

Note: The 57020 Actuator is sold separately.

Packaging

Packaging Option	Packaging Specification	Quantity	Quantity & Packaging Code	Taping Width
Bulk	Bulk	500	N/A	N/A